

OPERATING INSTRUCTIONS Commercial Dishwasher PFD 401 / PFD 404





To prevent accidents and machine damage, read these instructions **before** installation or use.

en-US, CA

Contents

Guide to the manual	6
Symbols used on the commercial dishwasher.....	7
Definition of terms	7
IMPORTANT SAFETY INSTRUCTIONS	8
APPROPRIATE USE	8
Warning signs and symbols attached to the dishwasher.....	12
Disposal of your old dishwasher	13
Caring for the environment	14
Machine description	15
Appliance overview	15
Control panel.....	16
LEDs in the buttons.....	17
User profiles	18
User groups.....	18
Operation tips	19
Switching on.....	19
Switching off.....	19
Standby/Off	20
Display illustrations.....	20
Touch display	20
Lists.....	20
Setting numerical values	20
Status window	21
Fault messages 	21
Commissioning	22
Installation and connection	22
Procedure	22
Switching on	22
Selecting the language.....	22
WiFi setup	22
Setting the date.....	22
Setting the time of day.....	23
Setting the temperature units.....	23
Setting the water hardness	23
Selecting water connections.....	24
Commissioning completed	24
Opening and closing the door	25
Door lock	25
Comfort Door Lock	25
Pull-open lock	26
Filling the container for reactivation salt	27
Water hardness	27
Setting the water hardness	27
Salt refill indicator.....	29
Reactivation notification.....	29
Machine blocked if salt is not available.....	29

Cleaning agent and rinsing agent	31
Dispensing systems	31
Dispenser module	31
Process chemicals	32
Filling the door dispenser.....	32
Tips for the Rapid program	33
Refill indicator	34
Replacing the media canister.....	34
Rinse aid.....	35
Refill indicator	35
Filling the door dispenser.....	35
Refill indicator	36
Replacing the media canister.....	36
Loading the dishwasher	37
Preparing the wash items.....	37
It is recommended.....	38
Upper basket.....	39
Adjusting the upper basket	40
Lower basket.....	41
Use of plastic trays.....	42
Operation	43
Switching on.....	43
Selecting a program	44
Starting a program	44
Starting the program using a timer	44
Program sequence display.....	45
End of the program	46
Switching off.....	46
Unloading the dishware.....	46
Interrupting a program.....	46
Canceling a program	47
 Machine functions	48
Menu structure	48
Filter interval	49
Dispensing paths.....	49
Filling dispensing paths	49
Rinsing dispensing paths.....	50
Dry+	51
Program selection	51
Extension.....	51
AutoOpen	52
AutoClose.....	52
 Settings	53
Menu structure	53
Time of day.....	54
Date	55
Display brightness.....	56
Volume.....	56
Welcome tone	57

Contents

Temperature unit.....	57
 Additional settings	58
Menu structure	58
Filter program lock	61
Standby/Off	61
Log book	62
Program release	63
Set Favorites.....	63
Program parameters.....	64
Selecting a program	64
Wash temperature	64
Main wash holding time	64
Final rinse temperature.....	65
Final rinse holding time	65
Increased water level	65
Changing the name.....	66
Interim rinse.....	66
Resetting parameters	66
A0 value display	67
Dispensing systems	67
Selecting a dispensing system	67
Door dispenser.....	68
Activating dispensing from the media canister	69
Deactivating dispensing from the media canister	69
Dispensing concentration	70
Filling dispensing paths	70
Rinsing dispensing paths.....	70
Cycles until empty.....	70
Water hardness	70
Reactivation notification	71
Memory	71
PIN code.....	72
Entering a PIN code	72
Blocking further settings or making them available.....	72
Changing the PIN code.....	73
Door lock code.....	73
Networking/WiFi	74
WiFi setup	74
Connection via WPS	74
Soft AP	75
Connecting via Soft-AP.....	75
RemoteUpdate	76
Demo mode.....	76
Software version.....	76
Data plate	76
Factory default settings.....	77
Legal information.....	77
Cleaning and care	78
MAINTENANCE.....	78
Wipe lock.....	79

Cleaning the control panel	79
Cleaning the machine front	79
Cleaning the wash cabinet.....	80
Cleaning the door and the door seal.....	80
Cleaning filters in the wash cabinet.....	80
Changing the air filter (depending on the model).....	82
Removing the plastic support.....	82
Replacing the filter	82
Troubleshooting	83
Technical faults.....	83
Faults with water inlet or drainage.....	84
Cancel with fault code.....	85
Door.....	87
General problems with the dishwasher.....	88
Noises.....	90
Poor cleaning results	91
Frequently asked questions	93
Cleaning the water inlet filter.....	93
Cleaning the drain pump and non-return valve.....	94
Program chart	95
Program parameters	96
Miele Service	99
INSTALLATION INSTRUCTIONS	100
Installation	101
Installation	101
Undercounter installation	101
Hose holder	101
Adjustable toe-kick panel (depending on the model).....	102
Leveling and securing the dishwasher	103
Leveling and securing the dishwasher.....	104
Moving the dishwasher's installation site.....	104
Electrical connection	105
GROUNDING INSTRUCTIONS	105
Peak-load negotiation	106
Plumbing	107
Connecting the water inlet	107
Connecting the water drainage system.....	108
Technical details	109

Warnings

 Warnings contain information related to safety. This alerts you to the potential danger of injury to people or damage to property. Read the warnings carefully and follow the instructions and directions.

Notes

Notes contain information that is particularly important to follow.

Additional information and comments

Additional information and comments are contained in a simple frame.

Operating steps

Instructions on operation are identified by specially marked operating steps. They explain the procedure step by step. Operating steps are indicated by a black square bullet point.

Example:

- Open the door.





Display

Information that is shown in the Commercial Dishwasher display appears in a special font similar to the display text.

Example:

Select  Settings and confirm your choice with the *OK* button.

Symbols used on the commercial dishwasher

Symbol	Legend
	For warnings and safety notes; see “IMPORTANT SAFETY INSTRUCTIONS”
	ETL mark
	Do not dispose of electrical machines in household waste; they need to be disposed of separately, see “Disposal of your old machine”
	Manufacturer

Definition of terms

Dishwashers

The commercial dishwasher is referred to as a dishwasher in these operating instructions.

Wash items

The term “wash items” is used wherever the items to be reprocessed are not defined in any further detail.

Wash water

The term “wash water” is used for the mixture of water and process chemicals.

Process chemicals

All media dispensed during a program sequence are generally referred to as process chemicals, e.g., cleaning agents.

Cycle

Machine-based cleaning and reprocessing procedures are generally referred to as cycles.

IMPORTANT SAFETY INSTRUCTIONS

APPROPRIATE USE

This Commercial Dishwasher complies with all current local and national safety requirements. Inappropriate use can, however, lead to personal injury and material damage.

WARNING:

When using your dishwasher, follow basic precautions, including the following:

Read the operating instructions carefully before using the Commercial Dishwasher for the first time. They contain important information on the safety, use, and maintenance of the machine. Keep these operating instructions in a safe place and pass them on to any future user.

- ▶ This Miele Dishwasher with its short program cycle times and powerful cleaning performance is intended for commercial use, for example in:
 - senior living facilities
 - butler pantries in residential homes
 - restaurants and pubs
 - hotels and guesthouses
 - similar commercial environments
- ▶ The commercial dishwasher is subsequently referred to as a dishwasher in these operating instructions.
Glasses, cutlery and dishes are referred to generally as cookware when not more specifically defined.
- ▶ This machine is designed exclusively for use as a “dishwasher” for cleaning wash items as described in these instructions. Conversions, modifications, and any other use are not permitted.
- ▶ This dishwasher is intended for stationary, indoor use only.
- ▶ The special inserts in the baskets should only be used for their specific application.
- ▶ This dishwasher is not intended to be used to clean medical devices or products.
- ▶ This dishwasher can only be used by people with reduced physical, sensory or mental capabilities, or lack of experience or knowledge, if they are supervised while using it or have been shown how to use it in a safe way and understand and recognize the consequences of incorrect operation.
- ▶ This dishwasher should only be operated by appropriately trained personnel. They should be instructed and trained regularly.
- ▶ Children should be supervised in the vicinity of the dishwasher. Never allow children to play with the dishwasher. There is a danger that children might shut themselves in the dishwasher.
- ▶ Children must not use the dishwasher.

IMPORTANT SAFETY INSTRUCTIONS

Proper installation

- ▶ Do not install the machine in an area where a danger of explosion or of freezing temperatures may be present.
- ▶ To ensure the stability of undercounter dishwashers, these units may only be installed beneath a continuous countertop that is bolted to adjacent cabinetry.
- ▶ In order to reduce the risk of damage from condensation, the cabinetry in the area around the dishwasher should be designed for commercial use. Delicate cabinetry can be protected using the damp protection set, which is available as an optional accessory. The vapor barrier film needs to be adhered to the underside of the countertop where the dishwasher door is opened.

Technical safety

- ▶ This dishwasher should be installed, commissioned, repaired, and maintained by Miele Service, a dealer, or a suitably qualified specialist. Unauthorized installation, maintenance, and repairs can cause considerable danger for the user.
- ▶ This dishwasher should only be operated by appropriately trained personnel. They should be instructed and trained regularly.
- ▶ Do not operate your dishwasher unless all enclosure panels are properly in place. Before using the dishwasher, check it for any externally visible damage. Do not use a damaged dishwasher. This could be dangerous.
- ▶ In the event of a damaged or leaking dishwasher, switch off at the power supply immediately and call Miele Technical Service, a Miele dealer, or a suitably qualified service technician.
- ▶ Faulty components should only be replaced by genuine Miele original parts. Only when these parts are fitted can Miele guarantee the safety standards of the appliance.
- ▶ **WARNING** – Improper connection of the equipment-grounding conductor can result in a risk of electric shock. Check with a qualified electrician or service representative if you are in doubt whether the appliance is properly grounded. Do not modify the plug provided with the appliance, if it will not fit the outlet, have a proper outlet installed by a qualified electrician.
- ▶ Please follow the advice on installation in these operating instructions and the installation plan.
- ▶ Ensure that the connection data on the data plate (voltage, frequency, and fuse rating) match those of your electrical supply.
- ▶ **WARNING** - Fire hazard! Do not cover or crush the plug of the appliance. Ensure that the cabinet opening for the dishwasher provides ample space for the plug and cord. Installing the dishwasher in a tight space may crimp the power cord or put pressure on it. See “Electrical connection”.
- ▶ Do not use an extension cord to connect this machine to electricity. Extension cords do not guarantee the required safety of the machine (e.g., danger of overheating).

IMPORTANT SAFETY INSTRUCTIONS

- ▶ Do not open the casing of the dishwasher. Any contact with live connections or tampering with the electrical or mechanical components of the dishwasher will endanger your safety and may lead to machine malfunctions.
- ▶ The dishwasher must not be used if the wire is damaged. A damaged wire may only be replaced by a suitable wire of the same type. For safety reasons, such replacement should only be carried out by Miele Technical Service or a qualified service technician.
- ▶ Before servicing the appliance, disconnect it from the power supply.
- ▶ The plastic housing of the water connection contains electrical components. It must not be dipped in water.
- ▶ There are live wires in the water intake hose. Do not shorten the water intake hose, even if it is too long.

IMPORTANT SAFETY INSTRUCTIONS

Correct use

- ▶ This dishwasher is designed for operation with water and cleaning agents suitable for use in dishwashers only. Organic solvents and flammable liquid agents must not be used. This could cause an explosion, damage rubber or plastic components in the dishwasher, and cause liquids to leak out of it.
- ▶ Only use cleaning agents formulated for use in dishwashers. Unsuitable cleaning agents could adversely affect components of the dishwasher or the wash items.
- ▶ Do not sit, stand, or lean on the opened door or dish rack. This could tip or damage the dishwasher.
- ▶ After any plumbing work, the water pipework to the dishwasher will need to be vented. If this is not done, components can be damaged.
- ▶ Please be aware that the dishwasher may be operating at high temperatures. When the door is opened there is a risk of burning or scalding. Wash items, baskets, and inserts must be allowed to cool down before they are unloaded. Any water remaining in containers could still be very hot. Empty them into the wash cabinet before taking them out.
- ▶ The water in the wash cabinet is NOT safe to drink!
- ▶ The pretreatment of items (for example with dishwashing liquid and other detergents), but also some types of soiling and some detergents, can cause a build-up of foam in the wash cabinet. Foam can have an adverse effect on the cleaning result.
- ▶ Foam escaping from the wash chamber can cause damage to the dishwasher. If foam escapes, the program must be canceled immediately and the dishwasher must be disconnected from the mains electrical supply.
- ▶ Depending on the properties of the flooring and footwear worn on it, liquids can cause a slipping hazard. Keep the floor dry where possible and take care to clean up any liquid spills straight away. Take the necessary precautions when cleaning up hazardous substances and hot liquids.
- ▶ When using cleaning agents and specialized products, it is essential that the manufacturer's instructions are followed. Cleaning agents must only be used for the purpose they are designed for by the manufacturer to avoid any material damage or the occurrence of strong chemical reactions (e.g., oxyhydrogen explosion).
- ▶ Under certain conditions, hydrogen gas might be produced in a hot-water system that has not been used for two weeks or more. **HYDROGEN GAS IS EXPLOSIVE.** If the hot-water system has not been used for such a period, before using the dishwasher turn on all hot-water faucets and let the water flow from each for several minutes. This will release any accumulated hydrogen gas. As the gas is flammable, do not smoke or use an open flame during this time.
- ▶ To avoid material damage and corrosion, do not allow any acids or solutions containing chloride to get into the wash cabinet or onto the casing. Similarly avoid any ferrous materials with a corrosive effect.
- ▶ Do not wash items soiled with ash, sand, wax, lubricating grease, or paint in the dishwasher. These materials will cause damage to the dishwasher.
- ▶ Do not clean the dishwasher or its near vicinity with a hose or a pressure washer.

IMPORTANT SAFETY INSTRUCTIONS

- ▶ Ensure that the outer casing of the machine does not come into contact with solutions or steam containing acid to avoid any corrosion damage.
- ▶ Be careful when sorting items with sharp pointed ends and positioning them in the dishwasher so that you do not hurt yourself or create a danger for others. Cutlery should be placed in baskets in such a way that no injuries can occur.
- ▶ Arrange sharp and pointy utensils so that they cannot damage the door seal.
- ▶ The grille of dishwashers with active drying must not be blocked or sealed.

Accessories

- ▶ Only use genuine Miele original spare parts and accessories with this dishwasher. Miele will provide you with the article designations of the accessories.
- ▶ Only use Miele baskets and inserts with this dishwasher. Using baskets and inserts made by other manufacturers, or making modifications to Miele accessories can cause unsatisfactory cleaning results, for which Miele cannot be held liable. Any resultant damage would not be covered by the guarantee.

Warning signs and symbols attached to the dishwasher

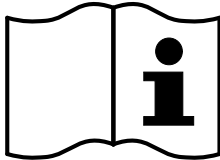

Attention:
Observe the operating instructions!

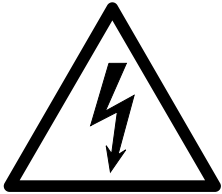

Attention:
Danger of electric shock!



Warning: Hot surfaces:
It can be very hot inside the wash cabinet when the door is opened!



Risk of being cut:
Wear cut-resistant protective gloves when transporting and setting up the machine!

IMPORTANT SAFETY INSTRUCTIONS

Disposal of your old dishwasher

- ▶ For safety and environmental reasons, dispose of all process chemicals according to the manufacturer's instructions and to safety regulations. Safety goggles and protective gloves should be worn.
- ▶ Remove or disable the door lock, so that children cannot become trapped inside. Ensure a safe removal and proper disposal of the dishwasher (see "Caring for the environment").

Transport

- ▶ Only transport the dishwasher in an upright position so that no water flows into the electrical controls, as this would cause faults.
- ▶ If you wish to transport the dishwasher, empty it and securely fasten all loose parts such as baskets, hoses, and cords.

After use

- ▶ Remove the door to the washing compartment when removing an old dishwasher from service or discarding it.

Miele cannot be held liable for damage caused by failure to comply with these IMPORTANT SAFETY INSTRUCTIONS.

SAVE THESE INSTRUCTIONS

Caring for the environment

Disposal of the packing material

The cardboard box and packing materials protect the appliance during shipping. They have been designed to be recyclable.

Ensure that any plastic wrappings, bags, etc. are disposed of safely and kept out of the reach of children. Danger of suffocation!

Disposal of your old appliance

Electrical and electronic appliances contain valuable materials. They also contain certain substances, compounds and components which were essential for the proper functioning and safe use of the equipment. Handling these materials improperly by disposing of them in your household waste can be harmful to your health and the environment. Therefore, please do not dispose of your old appliance with regular household waste and follow local regulations on proper disposal.



Consult with local authorities, dealers or Miele in order to dispose of and recycle electrical and electronic appliances. Miele assumes no responsibility for deleting any personal data left on the appliance being disposed. Please ensure that your old appliance is kept away from children until removal. Observe safety requirements for appliances that may tip over or pose an entrapment hazard.

Appliance overview

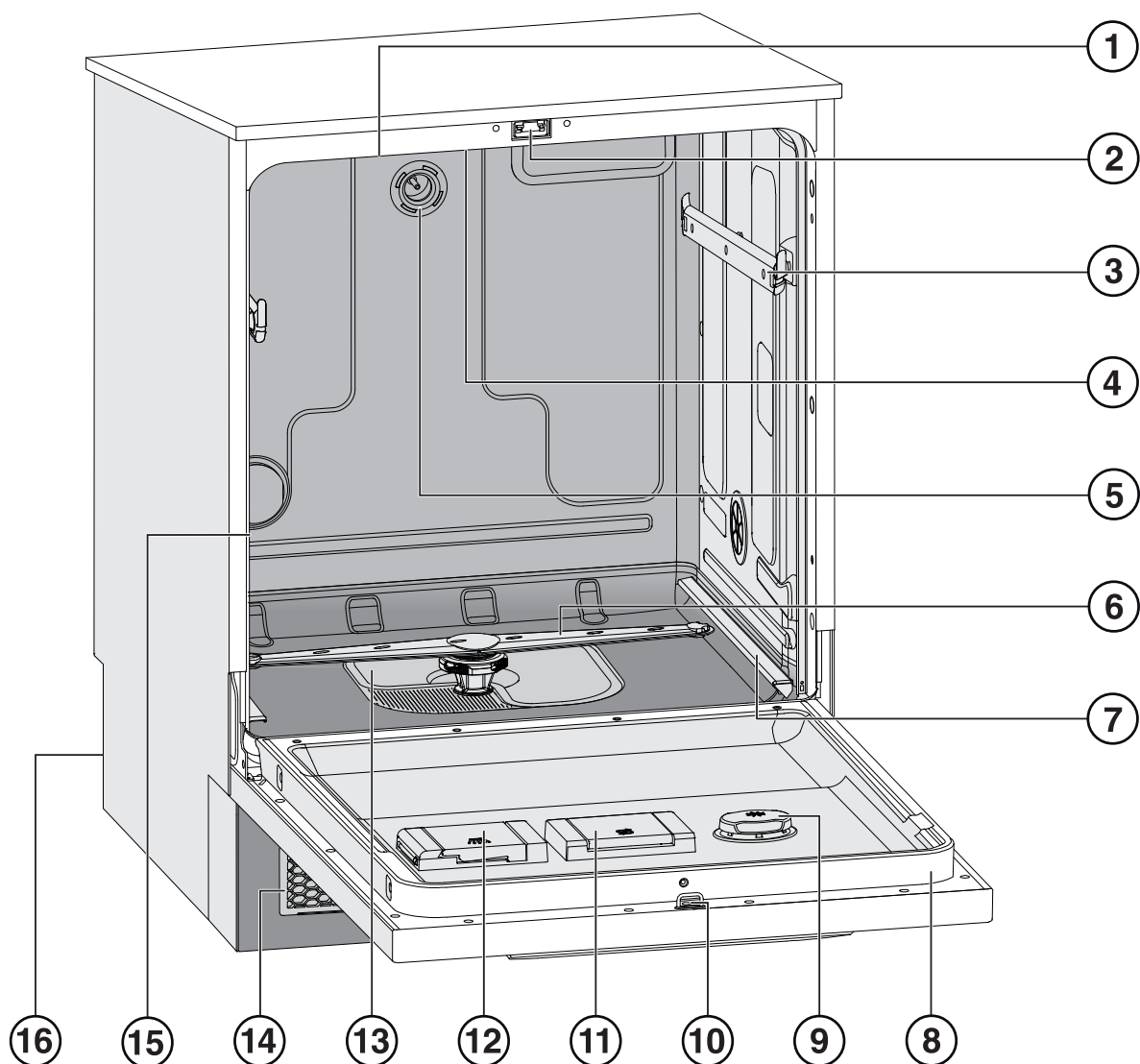

- | | |
|--|--|
| ① Air inlet for fresh air (depending on the model) | ⑨ Rinsing agent container |
| ② Door lock | ⑩ Door lock latch |
| ③ Upper basket runners | ⑪ Container for reactivation salt |
| ④ Top machine spray arm | ⑫ Container for powder cleaning agents |
| ⑤ Upper basket water connection | ⑬ Filter combination |
| ⑥ Lower machine spray arm | ⑭ Air outlet and inlet grille with filter for fresh air (depending on the model) |
| ⑦ Lower basket runners | ⑮ Outlet for wash cabinet air (depending on the model) |
| ⑧ Data plate | ⑯ Rear: |
| | – electrical and water connections |
| | – suction wand(s) for external containers (depending on the model) |
| | – connections for external dispenser modules (DOS modules) |

Machine description

Control panel

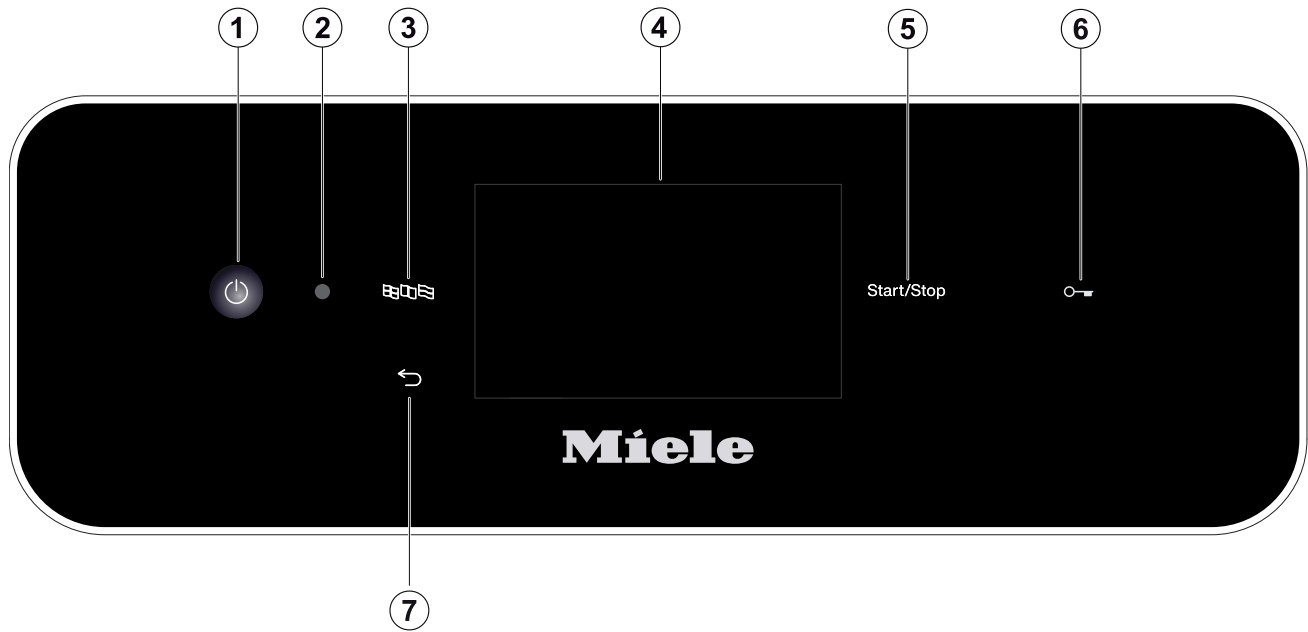

- ① On/Off switch
For switching the dishwasher on and off
- ② Service interface
Testing and transmission point for Miele Customer Service
- ③ button (language selection)
For selecting the display language
- ④ Touch display
For displaying and selecting control elements

- ⑤ *Start/Stop* button
For starting or canceling a program
- ⑥ (Depending on the model)
 button (door release)
For opening the door
- ⑦ button (cancel or back)
For canceling a process in the user interface (not for canceling programs)

LEDs in the buttons

Light-emitting diodes are incorporated in the buttons. They indicate the status of the dishwasher.

Button	LED	Display	Status
Display (Reaction to ⏻ On/Off switch)		ON	The dishwasher is switched on.
		OFF	The dishwasher is switched off.
<i>Start/Stop</i> button	Pulsing	OFF	The dishwasher is in standby mode.
		ON	A program has been selected, but has not yet started.
		ON	A message has appeared on the display.
	Flashes red		A fault has occurred (see the fault message on the display and the “Problem solving guide”).
	ON		A program is running.
	OFF		A program has finished.
(Depending on model)			
⏻ button (door button)	ON		A program has been selected, but has not yet started.
			A program is running.
	FLASHING		A program has finished and the door is closed.

User profiles

User groups

Users can be divided into two groups:

- **Daily operators**

Daily operators must be instructed on the functions and on operating and loading the dishwasher and trained regularly to guarantee safe daily use.

- **Experienced operators**

Experienced operators can additionally block access to programs and modify program parameters. These functions are stored in a PIN code-protected area of the control unit.



Operation

Operation is carried out via the touch display as well as via the buttons on the control panel.

The sensor controls on the control panel and the buttons on the display react to finger tip contact. Every touch on the sensor controls is confirmed by a keypad tone. You can adjust the volume of the keypad tone or switch it off (see “Settings/Volume”).

The control panel with sensor controls and the touch display can be scratched by pointed or sharp objects, e.g., pens. Only touch the control field with your fingers.

Switching on

The dishwasher needs to be connected to the electricity supply.

- Press and hold the  button until the following appears on the display:



As soon as the dishwasher is ready for operation, the display message changes to show the program selection screen, e.g.:

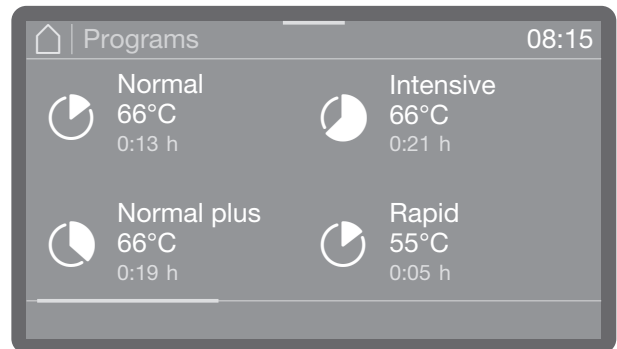

If the Memory function is activated, the most recently started program is displayed, e.g.:

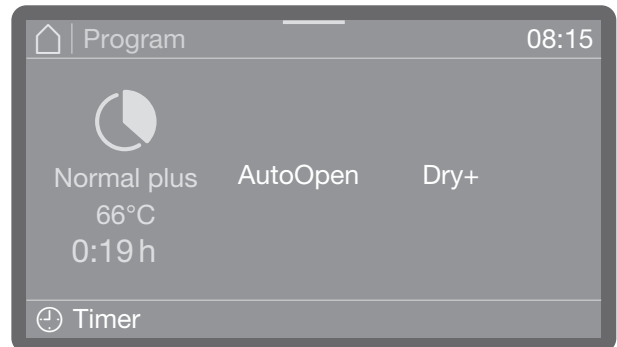

Switching off

- Press the  button.

The dishwasher remains in standby mode for about one minute before it switches off completely.

Operation tips

Standby/Off

If the dishwasher has not been used for 10 minutes, it can be set to standby or switched off automatically.

In standby mode, the dishwasher remains switched on and the *Start/Stop* button flashes. The dishwasher can be reactivated by pressing the *Start/Stop* button, touching the display, or opening the door.

After automatic switch-off, the dishwasher is switched off and can be switched on again by pressing the  button.

Display illustrations

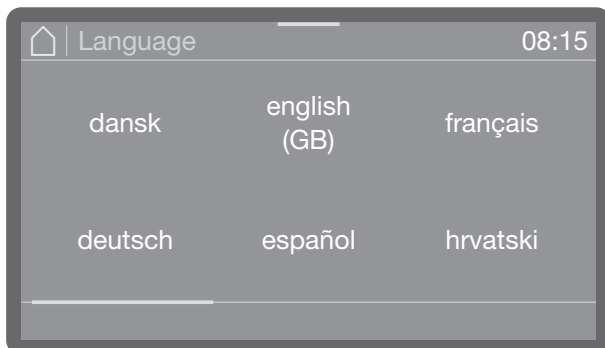

All display illustrations shown in these operating instructions are examples which can be different from the actual display screens shown.

Touch display

Lists

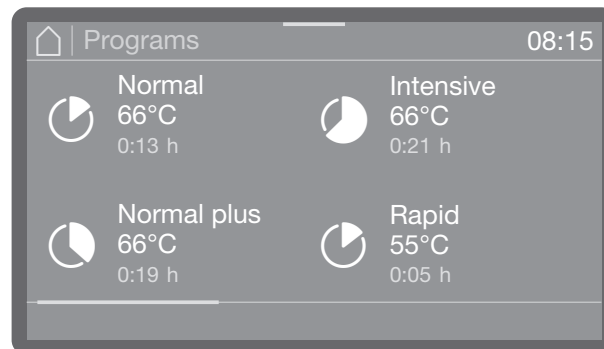

You can scroll to the right or the left by swiping your finger across the screen. To do this, place a finger on the touch display and swipe it in the direction you want.

The colored scroll bar shows that there are further options to choose from.

Setting numerical values

Numerical values can be entered in 2 different ways.

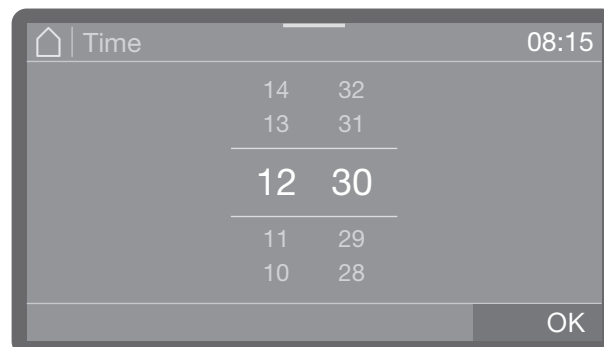

Firstly, you can place a finger on the numbers highlighted in color and change them by swiping up or down.

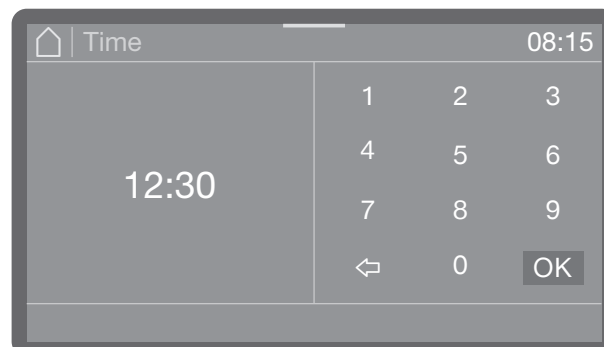

Secondly, you can call up a numerical keypad by briefly tapping the numbers highlighted in color and then entering the numbers directly.

Depending on the context, numbers entered directly may be rounded up or down. If, for example, it is only possible to enter values in increments of 10 (10, 20, 30, etc.), the value is rounded down to 10 when you enter 12, and rounded up to 20 when you enter 15.

Status window

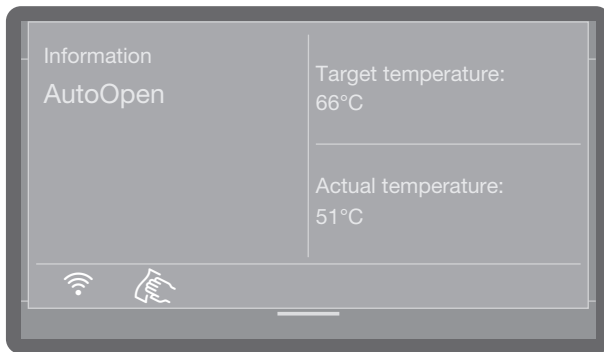

A colored bar is shown at the top of the display. If you tap this and drag it down, a status window opens. You can use this to display various status messages, e.g., about the program in progress.

System messages **i**

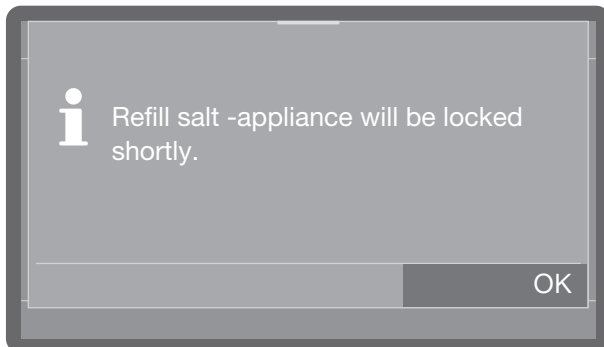

The **i** symbol denotes system messages. These give information about current processes and the status of the machine. System messages are displayed at the end of the program. If there is more than one system message, they are shown one after the other and must be acknowledged individually by pressing **OK**.

Show me how

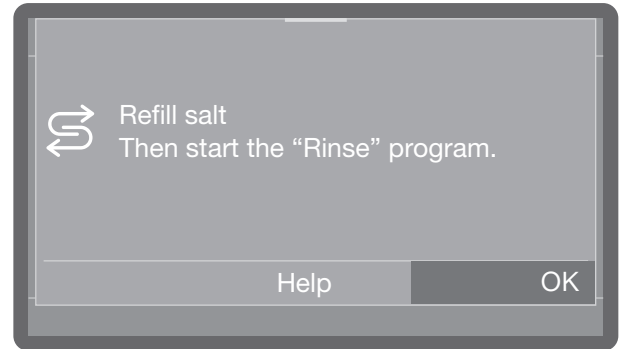

If you are notified of a fault or defect when switching on the machine or at the end of the program and the **Help** button is presented to you, you can tap the **Help** button to be guided through the individual steps to be carried out in order to eliminate the fault or defect.

Fault messages **!**



In the event of a fault, a warning symbol **!** appears on the display and the *Start/Stop* button flashes red in rapid succession. If audible signals are activated, a warning tone will also sound.

- Acknowledge the fault by tapping on the warning symbol. Then follow the instructions on the display and in the "Frequently asked questions".



Commissioning

Installation and connection

Before commissioning, the dishwasher must be securely installed, and the water inlet, drain hoses, and the power cord correctly connected. Follow the instructions in “Installation”, “Water connection”, and “Electrical connection” as well as the installation plan.

Procedure

The commissioning process requires a set period of time which cannot be interrupted.

All settings, except for water connections, can be retrospectively altered via the  Machine functions,  Settings, and  Extended settings menus.

Switching on

- Press the  button.

Selecting the language

Commissioning starts with the selection of the display language.

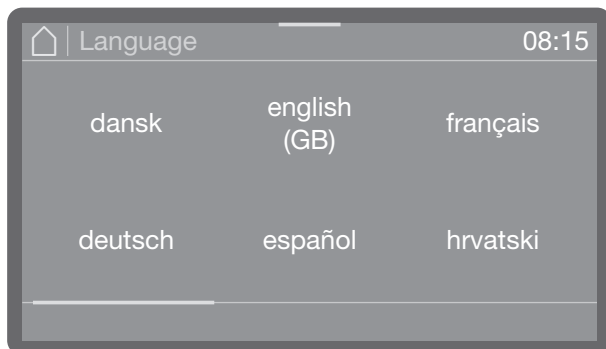

- Scroll to the language you want and select it by tapping on it.

WiFi setup

In the next step, you can connect your dishwasher to the WiFi network.

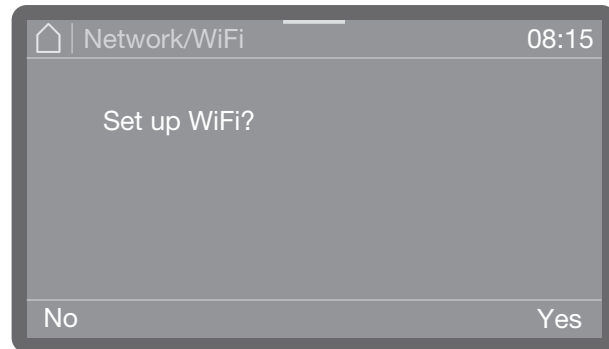

- Select No if you do not want to integrate the dishwasher into the WiFi network or want to do it later.
- If you select Yes, the next steps will guide you through the process to set this up. Please refer to “Further settings, Networking/WiFi”.

Setting the date



- Set the date. The order of year, month, and day is the same regardless of the date format set.
- Press  to save the setting.

Setting the time of day

The time of day is set in the set time of day format.

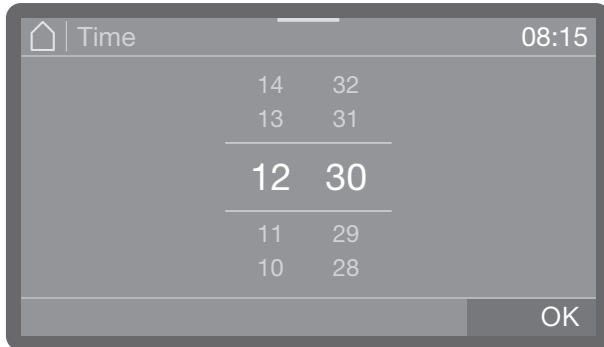

- Set the time of day and confirm your selection with the OK button.

Setting the temperature units

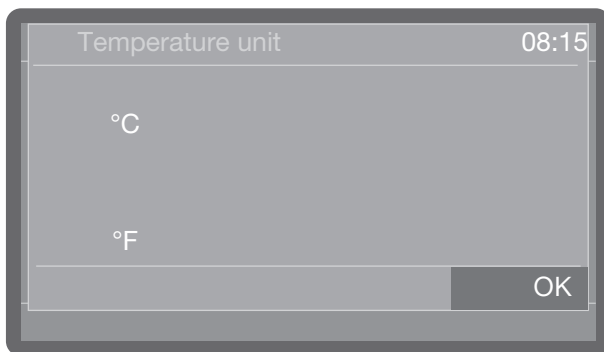

- °C
Temperature display in Celsius.
 - °F
Temperature display in Fahrenheit.
- Select the temperature unit you want and confirm your selection with the OK button.

Setting the water hardness

Your local water authority can give you information about the water hardness level in your area.

With varying water hardness, always set the highest level. If the water hardness fluctuates between, for instance, 8.3 and 17.7 gpg (8 and 17°dH), the water hardness must be set to 17.7 gpg (17°dH).

The water hardness setting values can be found in the chart in “Filling the salt container”.

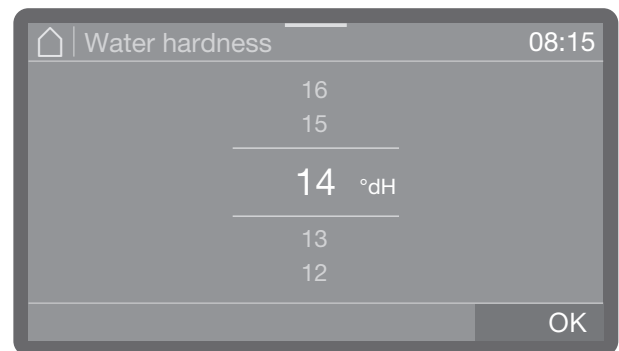

- Set the water hardness.
- Press OK to save the setting.

It is useful to know your water hardness so that you can provide the service technician with this information in the event of any subsequent service calls. Document the water hardness in “Filling the salt container”.

Commissioning

Selecting water connections

All available water connections are activated in the control system at the factory. Individual water connections can be subsequently deactivated, e.g., if no connection options are available for them.

Following commissioning, the water connections can be reinstated by Miele Customer Service.

- Select one of the available water connections, e.g.:

- Hot water

Hot water connection

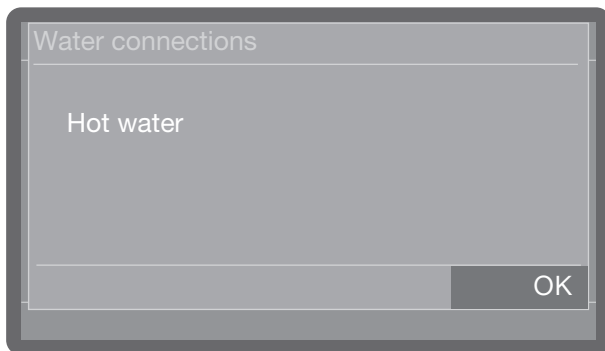

The activated water connection is highlighted in color. Tapping the connection removes the color and permanently deactivates the water connection.

- Select OK to confirm your choice.

Commissioning completed

Your machine has been successfully commissioned once you see the following message.

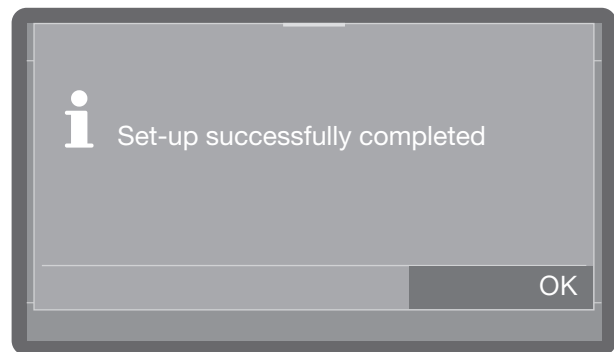

- Confirm the message with OK.

The dishwasher is now ready for operation.

Door lock



Depending on the model, the dishwashers are equipped with a Comfort Door Lock with electronic door lock or a pull-open lock. Dishwashers with a Comfort Door Lock have a  door button on the control panel. This button is not available on machines with a pull-open lock.

Comfort Door Lock

The door of the wash cabinet is equipped with a Comfort Door Locking Mechanism. When the door is closed, the Comfort Door Locking Mechanism automatically pulls the door into the closed position and thus ensures it is sealed. The door is locked electronically.

For opening the door

A door that has been locked electronically can be opened under the following circumstances:

- The machine is connected to the power supply and switched on (the  LED is lit up).
- The  LED is lit.
- Press the  button to open the door.

If the temperature in the wash cabinet exceeds 153°F (67°C), a message is shown on the display: Hot wash cabinet: Risk of injury, take care when opening the door..

Press the  button again to open the door.

The Comfort Door Lock opens the door slightly. The LED in the button goes out as soon as the door is unlocked.

The control panel of the machine is also a door handle.

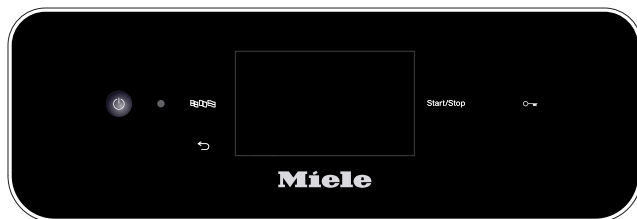

- Grasp the handle underneath the control panel and lower the door to open it.

Close the door.

- Make sure that no objects or wash items protrude into the closing area of the door.

 Risk of injury caused by crushing. Do not put your hand inside the door as it is closing. Risk of crushing.

- Raise the door upward until the catch engages.

The door will be drawn into its final close position if the AutoClose function is activated (see “AutoClose”).

Opening the door using the emergency release

The emergency release may only be used when it is no longer possible to open the door normally, e.g., in the event of a power failure.

 Danger of scalding, burning, and chemical burns!
If the emergency release is operated during a program sequence, hot water and process chemicals can escape. Only open the door using the emergency release when strictly necessary.

The emergency release mechanism is located on the right beside the door lock in the gap between the door and the lid of the machine or the countertop.

There should be 3/8" (1 cm) between the right edge of the tool and the right edge of the display.

- Press against the door to release the emergency release mechanism.



Opening and closing the door

- Insert the tool from the companion pack horizontally into the gap between the door and the lid or countertop.
- Press the tool against the release mechanism until you hear the door open. Continue to press the tool against the release mechanism and fully open the door.

If the machine is switched on, the following message is shown on the display when the emergency release is triggered:

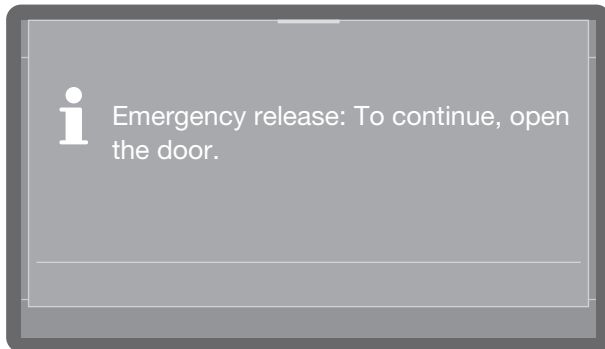

The message is acknowledged when the door is closed.

Pull-open lock

In the case of dishwashers with a pull-open lock, the door can be opened at any time, even during a program sequence. In the latter case, special caution is needed.

Opening the door

⚠ Danger of scalding, burning, and chemical burns!

If the door is opened during a program sequence, hot water and process chemicals can escape. The program in progress is also interrupted and, under certain circumstances, even canceled.

Do not open the door if a program is running.

The dishwasher control panel also serves as a door handle.

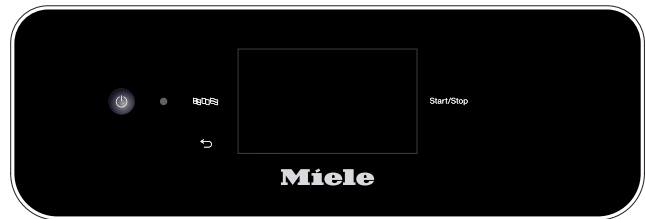

- Grasp the handle underneath the control panel and lower the door to open it.

Close the door.

- Make sure that no objects or wash items protrude into the closing area of the door.

⚠ Risk of injury caused by crushing.

Do not put your hand inside the door as it is closing. Risk of crushing.

- Raise the door upward until the catch engages.

Water hardness

In order to achieve excellent cleaning results, the machine requires a supply of soft water with a low calcium content. Hard tap water results in the build-up of calcium deposits on wash items and on the wash cabinet walls.

Tap water with a water hardness of 4 gpg (4°dH) or more must be softened. This occurs automatically during a program sequence in the built-in water softener.

The water softener must be set to the exact hardness of the tap water (see “Setting the water hardness”).

Your local water authority can give you information about the water hardness level in your area.

It is useful to know your water hardness so that you can provide the service technician with this information in the event of any subsequent service calls. Record the hardness of the tap water here:

_____ gpg or °dH

The water softener must be reactivated at regular intervals. Special reactivation salt is required for this. Reactivation is carried out automatically during a program sequence.

If the water hardness level of your water is consistently less than 4 gpg (= 4°dH), salt is not required for the water softener. The water hardness level must, however, still be set.

Setting the water hardness

Water hardness can be set between 0 and 70 gpg (0–70°dH).

The water hardness is preset to 14 gpg (14°dH) at the factory.

With varying water hardness, always set the highest level. If the water hardness fluctuates between, for instance, 8.3 and 17.7 gpg (8 and 17°dH), the water hardness must be set to 17.7 gpg (17°dH).

Water hardness setting values can be found in the chart on the next page.

The menu is saved under the following input path.

Extended settings

Water hardness



- Set the water hardness.
- Press **OK** to save the setting.

Filling the container for reactivation salt

Settings table

gr/gal	ppm CaCO ₃	mmol/l	Display
0	0	0	0
1	20	0.2	1
2	40	0.4	2
3	50	0.5	3
4	70	0.7	4
5	90	0.9	5
6	110	1.1	6
7	130	1.3	7
8	140	1.4	8
9	160	1.6	9
10	180	1.8	10
11	200	2.0	11
12	220	2.2	12
13	230	2.3	13
14	250	2.5	14 *)
15	270	2.7	15
16	290	2.9	16
17	310	3.1	17
18	320	3.2	18
19	340	3.4	19
20	360	3.6	20
21	380	3.8	21
22	400	4.0	22
23	410	4.1	23
24	430	4.3	24
25	450	4.5	25
26	470	4.7	26
27	490	4.9	27
28	500	5.0	28
29	520	5.2	29
30	540	5.4	30
31	560	5.6	31
32	580	5.8	32
33	590	5.9	33
34	610	6.1	34
35	630	6.3	35

gr/gal	ppm CaCO ₃	mmol/l	Display
36	650	6.5	36
37	670	6.7	37
38	680	6.8	38
39	700	7.0	39
40	720	7.2	40
41	740	7.4	41
42	760	7.6	42
43	770	7.7	43
44	790	7.9	44
45	810	8.1	45
46	830	8.3	46
47	850	8.5	47
48	860	8.6	48
49	880	8.8	49
50	900	9.0	50
51	920	9.2	51
52	940	9.4	52
53	950	9.5	53
54	970	9.7	54
55	990	9.9	55
56	1000	10.0	56
57	1020	10.2	57
58	1040	10.4	58
59	1060	10.6	59
60	1070	10.7	60
61	1090	10.9	61
62	1110	11.1	62
63	1130	11.3	63
64	1150	11.5	64
65	1160	11.6	65
66	1180	11.8	66
67	1200	12.0	67
68	1220	12.2	68
69	1240	12.4	69
70	1250	12.5	70

*) Factory default setting

Salt refill indicator

If the level in the salt container is low and a reactivation is carried out, the following message appears on the display:

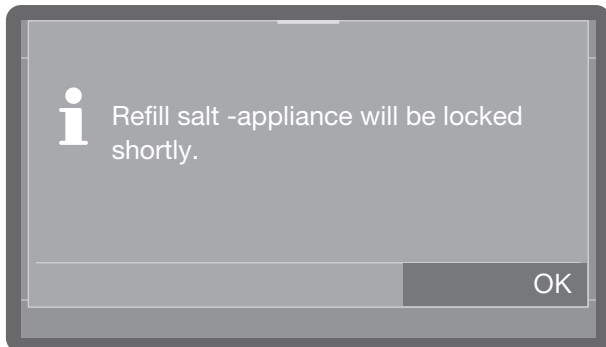

- Confirm the message with *OK*.
- Fill the salt container as described.

If the message is being displayed for the first time, further program runs may be possible depending on the set water hardness. If no salt is added, the message is displayed again at the end of every program.

Reactivation notification

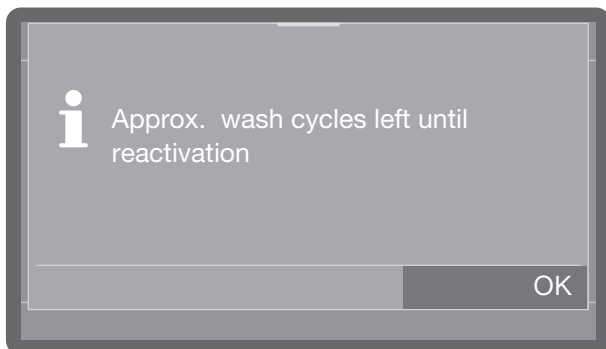

You can set how many cleaning cycles in advance you want to be notified of the upcoming reactivation; see "Extended settings", "Reactivation notification".

Machine blocked if salt is not available

If the salt in the water softener has been used up, a fault appears on the display and the machine blocked from performing further applications.



Acknowledge the fault by tapping on the warning symbol. Then follow the instructions on the display:

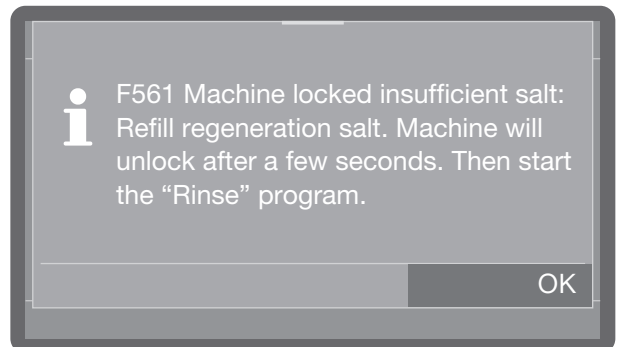

- Fill the salt container as described.

The machine lock is lifted with a delay of a few minutes once salt has been added.

Filling the container for reactivation salt

Filling the container for reactivation salt

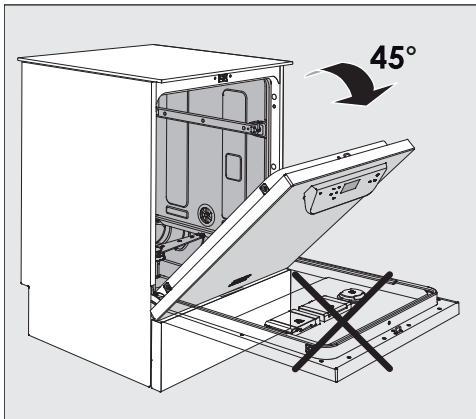

- When filling the salt container, **only open the door halfway** to ensure that all the salt gets into the container.

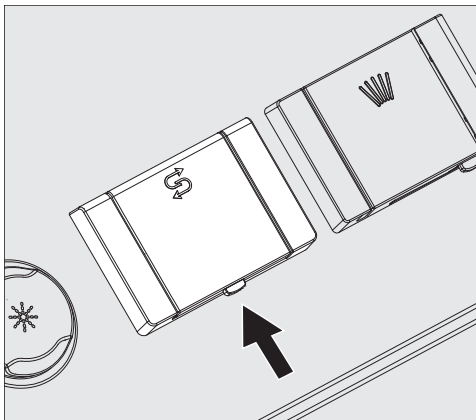

- Press the button on the lid of the salt container in the direction of the arrow. The access panel will spring open.
- Open the funnel.

Do not pour any water into the salt container!

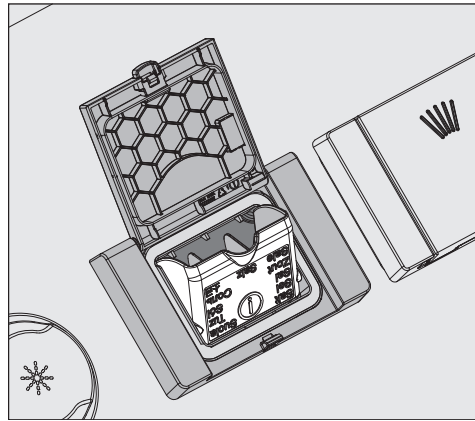

- Add salt into the container until the funnel is full but still closes easily. The salt container will take approx. 4.4 lb (2 kg) of salt on the first fill depending on the degree of coarseness. Subsequent refills may take less salt, as there may still be salt remaining in the container.

If there is water present in the container, it may be forced out by the added salt.

- Clean any excess salt from around the container opening and the seal surrounding it, and then close the flap.
- To avoid corrosion in the wash cabinet, run the **Rinse** program (without any wash items in the dishwasher) immediately after refilling the salt container. This will dilute and rinse away any remaining traces of salt.

Dispensing systems

⚠ Risk to health due to process chemicals.

Some process chemicals may be corrosive and irritant. Swallowing process chemicals can cause chemical burns in the mouth and throat or lead to asphyxiation. If process chemicals get into the eyes, they can irritate or burn them.

Observe the relevant safety regulations issued by the process chemical manufacturers when handling process chemicals and take all the protective measures stipulated by the process chemical manufacturers.

Depending on the model, dishwashers are equipped with multiple dispensing systems for process chemicals:

- **Cleaning agent**

Cleaning agent can be dispensed in powder form, as a tab, or in liquid form. Powder cleaning agent and tabs are dispensed via the door dispenser with the  symbol. Depending on the model, liquid cleaning agent is dispensed either via an internal dispensing system or via an external dispenser module (DOS module).

- **Rinsing agent**

Depending on the model, rinsing agent can be dispensed via the door dispenser with the  symbol or via an external dispenser module (DOS module).

External dispenser modules (DOS modules) can be retrofitted at any time by Miele Customer Service, provided that corresponding DOS module connections are available.

Dispenser module

In addition to the internal dispensing systems, up to two additional external dispensing systems (dispenser modules) can be connected for dispensing liquid process chemicals.

Labeling of the suction wands

Liquid process chemicals from external containers are dispensed by suction wands. Color coding the suction wands can be helpful for correct dispensing.

Specific types of soiling may require different combinations of cleaning agents and additives. Miele Customer Service will be able to advise you.

DOS modules

In the case of dishwashers without an internal dispenser pump for liquid cleaning agent, up to two additional, external dispenser modules for liquid process chemicals can be installed retrospectively. In the case of dishwashers with an internal dispenser pump for liquid cleaning agent, one additional, external dispenser module for liquid process chemicals can be connected.

External dispenser modules can be retrofitted by Miele Customer Service or by a suitably qualified specialist. Internal dispensing systems cannot be installed retrospectively.

The dispenser module comes with separate installation instructions.

Cleaning agent and rinsing agent

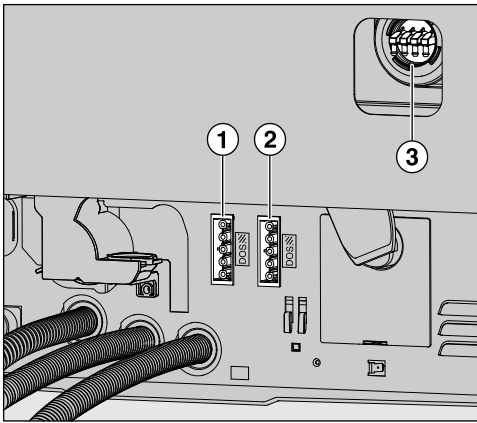

- ① Power supply connection for DOS 1, cleaning agent (depending on the model).
- ② Power supply connection for DOS 4, rinsing agent.
- ③ Connections for dispensing hoses.

⚠ Damage caused by incorrect voltage.
Before fitting the dispenser module, compare the connection data (voltage and frequency) on the data plate with that on the data plate of your machine. If the data does not match, the module could sustain damage.
If in any doubt, consult a qualified electrician.

- Connect the module to the machine's power supply.
- To connect the dispensing hose, release the hose clip on a free connector and remove the safety cap.
- Push the dispensing hose onto the connector and secure it with a hose clip.

Blank off unused connectors for dispensing hoses with safety caps to prevent the leakage of wash water.

Process chemicals

Only use cleaning agent suitable for commercial dishwashers.
Suitable products are available from the Miele Professional product range.

Cleaning agent can be dispensed in powder form, as a tab, or in liquid form.

Powder cleaning agent and tabs are dispensed via the door dispenser with the  symbol.

Only use cleaning agent tabs that are quick-dissolving. Suitable tabs are available from the Miele Professional product range.

Filling the door dispenser

⚠ Risk to health due to dust production.
When dispensing powder cleaning agents and tabs, dust from fine cleaning agents can be stirred up. If this dust gets into the mouth, throat, or eyes, it can cause irritation or burns.
When dispensing powder cleaning agents and tabs, avoid the production of dust as much as possible.

Add powder cleaning agent or a tab to the powder cleaning agent dispenser before every wash program (except Rapid, Cold, Re-activation, and Drain). Follow the tips on the Rapid program.

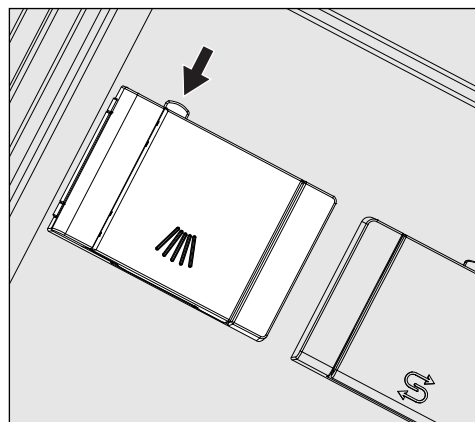

- Press the yellow button on the dispensing canister with the  symbol.

The flap will spring open. The flap is always open at the end of a program cycle.

Cleaning agent and rinsing agent

The level markers in the powder dispensing canister with the door in the horizontal position equate to the amount dispensed in milliliters (ml). The max. capacity is approx. 60 ml of cleaning agent.

The amount in ml equates to approx. the amount normally recommended in grams (g) for proprietary powder cleaning agents. Powder density can affect this amount.

Dispensing example:

Approx. 8.5 liters of water are taken into the machine for the main wash. With a cleaning agent concentration of approx. 3 g/l, you will need approx. 25 g of cleaning agent. Please observe the manufacturer's recommendations, which may vary!

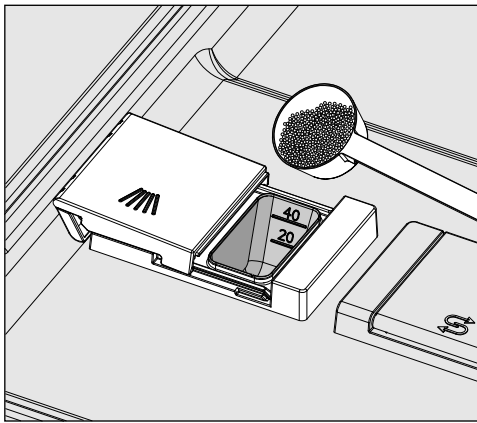

- Add cleaning agent to the dispensing canister.

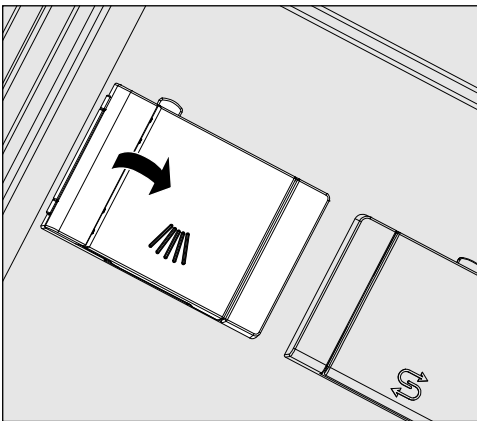

- Close the flap.

⚠ Make sure that all of the cleaning agent has dissolved at the end of the program sequence.

Repeat the program if residual cleaning agent is present.

Check whether any wash items have prevented the flushing out of the dispensing canister and rearrange the wash items if necessary.

Tips for the Rapid program

With the Rapid program (depending on the model), the final rinse water is not pumped away at the end of the program in order to achieve short program cycle times in continuous use.

Cleaning agent cannot be rinsed out of the dispenser during the short program cycle time.

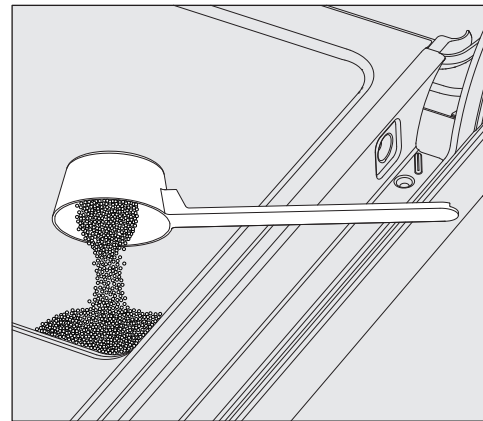

- If liquid cleaning agent dispensing is not being used, add powder cleaning agent directly onto the inside of the door.

To avoid corrosion or discoloration, start the wash program immediately after dispensing cleaning agent directly onto the inside of the door.

Cleaning agent and rinsing agent

Liquid cleaning agent is dispensed from an external media canister via a suction wand.

Depending on the model, liquid cleaning agent is dispensed either via an internal dispenser pump or via an external dispenser module. Dispenser modules are installed by Miele Customer Service and can be retrofitted at any time.

Refill indicator

When the fill level in the cleaning agent canister is low, you are reminded to change the media canister.

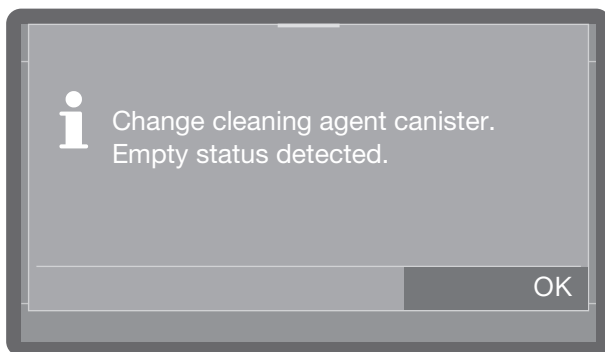

- Confirm the prompt with *OK* and change the cleaning agent canister.
- Fill the dispensing path (see “Machine functions”)

Replacing the media canister

- Place the liquid cleaning agent container (note the color marking) on the open wash cabinet door or on a surface which is robust and easy to clean.
- Take the lid off the canister and remove the suction wand. Place the suction wand on the open wash cabinet door.
- Replace the empty container with a full one.

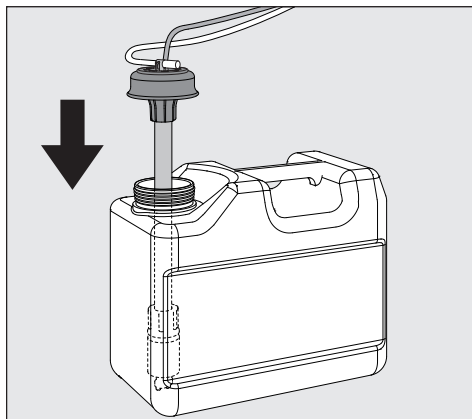

- Push the suction wand into the opening of the container and secure the lid. Observe the color coding.
- Feed the suction lance into the container until it reaches the bottom.
- If you use a long suction lance in a 5 litre canister, or the 10 litre canister is only half full, the following prompt appears in the display:

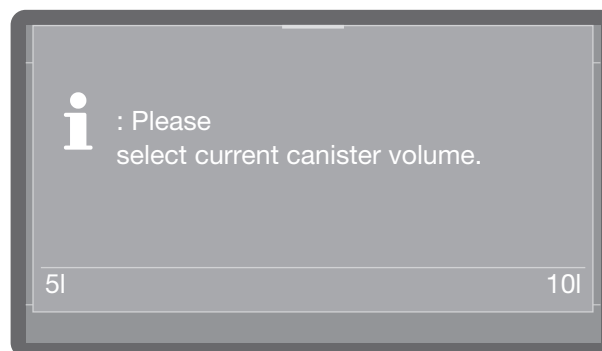

- Select the canister size.
- Wipe up any spilled process chemical thoroughly.

Rinse aid

Rinsing agent is necessary to ensure water does not cling and leave marks on wash items, and to help wash items dry faster after the final rinse.

The rinsing agent concentration must be adjusted in the following circumstances:

- If there are spots of water left on wash items after reprocessing, then the dispensing concentration is set too low.
- If clouding or smearing appears on wash items after reprocessing, the dispensing concentration is set too high.

The rinsing agent is dispensed in the Final rinse program stage. The container needs to be filled for this purpose.

In the Glasses program (depending on the model), the final rinse is carried out with cold water and without rinsing agent.

Refill indicator

When the fill level in the rinsing agent container is low, you are reminded to refill the dispensing canister, e.g.:

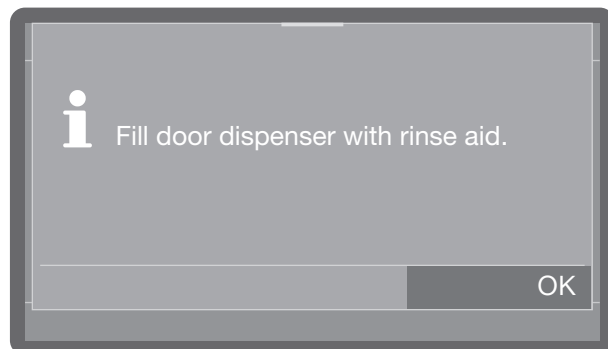



- Confirm the prompt with *OK* and top up the rinsing agent as described.
- Fill the dispensing path (see “Machine functions”)

Filling the door dispenser

⚠ Never add cleaning agent. This will always destroy the rinsing agent container!
Only fill the rinsing agent container with rinsing agent for commercial dishwashers.

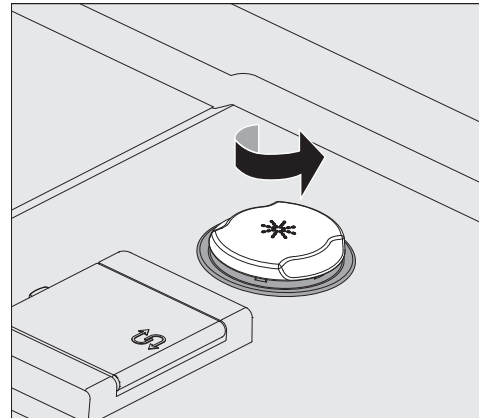
- Open the door fully.



- Unscrew the yellow lid with the  symbol in the direction of the arrow.

The container holds approx. (10 oz) 300 ml.

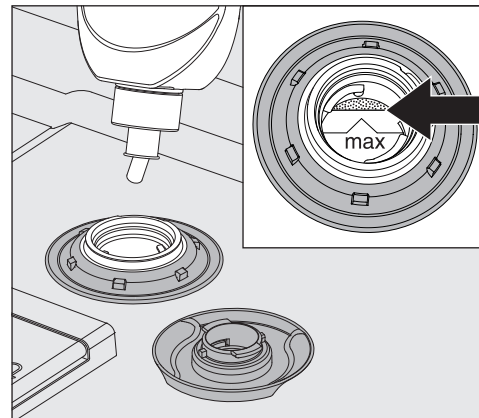

- Add rinsing agent only until it is up to the “max.” mark on the edge of the funnel.

Cleaning agent and rinsing agent

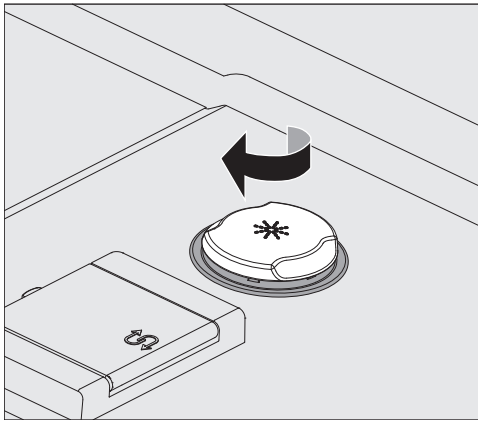

- Close the container.
- Wipe up any spilled rinsing agent thoroughly. This prevents over-foaming during the next program.
Alternatively, you can start the **Cold** program to rinse off any spilled rinsing agent.

Refill indicator

When the fill level in the rinsing agent container is low, you are reminded to change the media canister, e.g.:

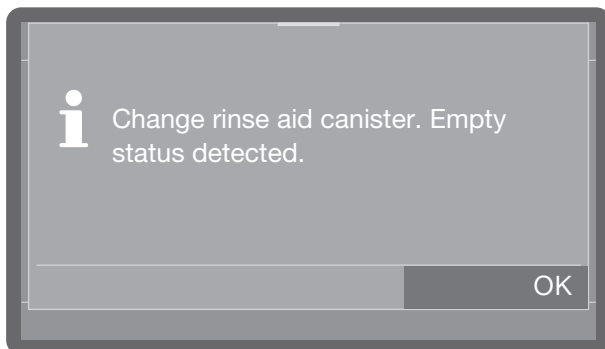

- Confirm the prompt with **OK** and change the rinsing agent canister as described.
- Fill the dispensing path (see "Machine functions")

Replacing the media canister

- Place the rinsing agent container (note the color marking) on the open wash cabinet door or on a surface which is robust and easy to clean.
- Take the lid off the media canister and remove the suction wand. Place the suction wand on the open wash cabinet door.
- Replace the empty container with a full one.

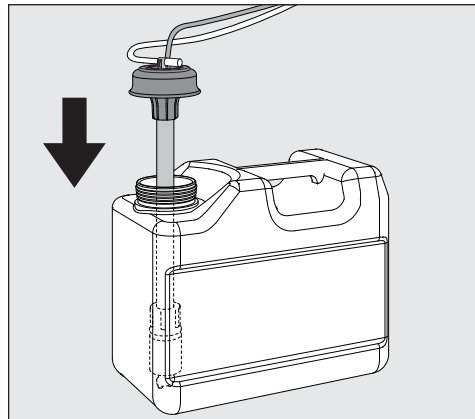

- Push the suction wand into the opening of the container and secure the lid. Observe the color coding.
- Feed the suction wand into the container until it reaches the bottom.
- Wipe up any spilled process chemical thoroughly.

Preparing the wash items

Remove coarse food residues from dishware.

There is no need to pre-rinse items under running water!

Tips

⚠ Risk of damage caused by acids and solvents.

Acid or solvent residues, especially hydrochloric acid or chlorides, may not get inside the wash cabinet.

Do not put acids or solvents in the wash cabinet.

⚠ Damage caused by items soiled with ash, sand, wax, lubricant, or paint

These materials will cause damage to the dishwasher.

Do not wash items soiled with ash, sand, wax, lubricant, or paint in the dishwasher.

Load dishware and utensils into the appropriate places in the baskets. The following notes should be observed:

- Load the dishware so that water can access all surfaces. This ensures that they get properly cleaned.
- Load plates symmetrically in the upper and lower baskets with the concave surfaces facing the center of the basket (as shown on the following pages).
- Do not place dishware or utensils inside other pieces. They will cover one another.
- Make sure that all items are securely positioned.
- Hollow items such as cups, glasses, pans, etc., must be inverted in the basket.
- Tall, narrow, hollow items should be placed in the center of the basket if possible. This ensures better water coverage.
- Concave items such as mugs or bowls should be placed at an angle so that the water can run off.

- The spray arms must not be blocked by items which are too tall or hang through the baskets. If in doubt, test for free movement by manually rotating the spray arms.

- If you need to wash large wash items in the lower basket, you can remove the upper basket.

- Small items can fall through the holders in the baskets. They should therefore be placed in the cutlery basket.

Wash items not suitable for dishwashers

- Wooden cutlery and dishware or items with wooden parts may discolor or fade. Furthermore, the glue used in these items is not dishwasher safe. Wooden parts may come loose after being washed in a dishwasher.
- Craft items, antiques, valuable vases, and decorative glasses are not dishwasher-safe.
- Plastic items which are not heat resistant may melt or lose shape.
- Copper, brass, tin, and aluminum items: these may discolor or become matte.
- Colors painted over a glaze may fade after a number of rinses.
- Delicate glasses and glassware containing crystal may become cloudy over time.

Loading the dishwasher

It is recommended

- When purchasing new dishware and cutlery, make sure they are dishwasher-safe if you want to wash them in the dishwasher.
- Clouding may occur on glasses after frequent rinses in the dishwasher. When washing delicate glasses in the dishwasher, ensure that only a special glass-care program with very low temperatures (see “Program overview”) is selected and that a suitable cleaning agent is used. This will reduce the risk of clouding.

Please note:

Silver and aluminum which has been in contact with foods containing sulfur can discolor.

 Risk due to chemical reaction
Aluminum components (e.g., grease filters) must not be cleaned in the dishwasher with caustic alkaline commercial or industrial cleaning agents. These may damage the material. In extreme cases, there is a risk of an explosive chemical reaction (such as an explosive oxyhydrogen gas reaction).
Do not clean pretreated aluminum components in the dishwasher.

Upper basket

Use the upper basket for small, lightweight, and delicate items such as cups, saucers, glasses, dessert bowls, etc. Light, heat-resistant plastic items can also be loaded in the upper basket.

Smaller shallow pots and pans can also be washed in the upper basket.

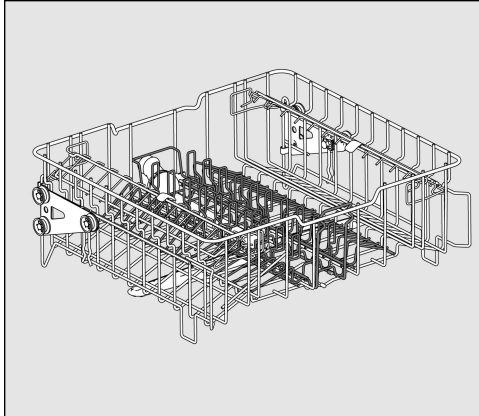

APFD 215 Upper Basket with APFD 415 Insert

The middle insert can be removed from the upper basket to wash larger pots and pans or to replace it with other inserts.

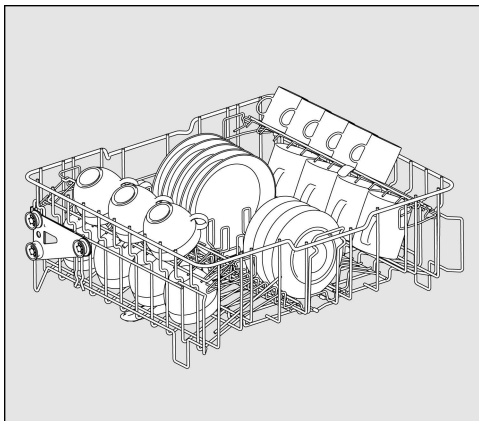

With APFD 415 Insert for 20 cups and 32 saucers or 18 dessert plates and 20 cups, for example.

FlexCare cup rack

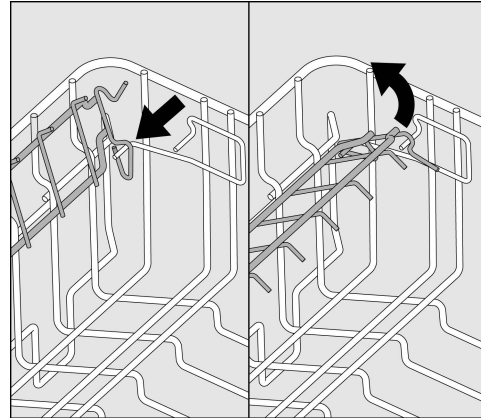

You can fold up the FlexCare cup rack to place large cups, glasses, and mugs in the upper basket.

- Fold up the FlexCare cup rack.

The upper basket can be removed in order to wash larger items in the lower basket (e.g., serving dishes).

Loading the dishwasher

Adjusting the upper basket

In order to obtain more space for taller items in the lower or upper basket, the upper basket can be adjusted between two vertical positions that are approx. 2" (5 cm) apart.

- Pull out the upper basket.

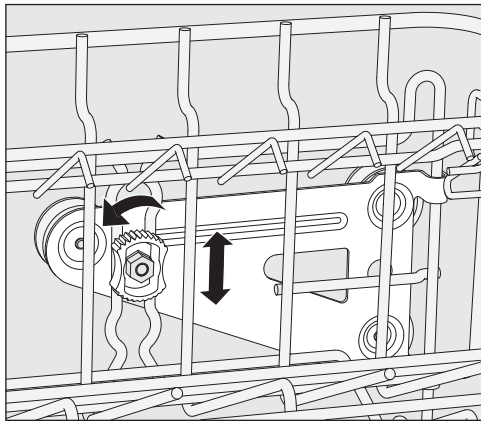

- Unscrew the lock nuts on both sides.
- Lift or lower the basket into the desired position.
- Tighten the lock nuts again.

The upper basket must be level in both positions.
If the upper basket is inclined, a water connection is not possible.

⚠ Damage caused by the water connection being positioned incorrectly.
The position of the water connection needs to be adjusted after the height of the upper basket has been changed.
When changing the height of the upper basket, always adjust the water connection accordingly before pushing the upper basket back in.

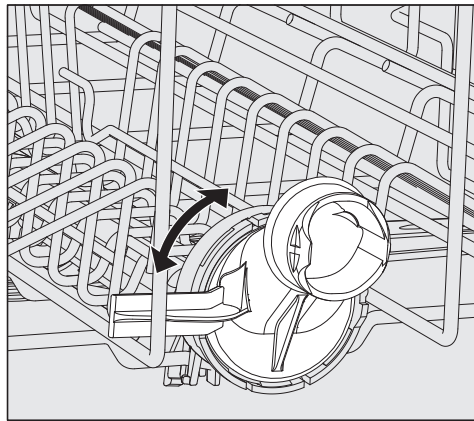

- Turn the upper basket water connection to the upper or lower position.
The water connection must click audibly into place.

Depending on the position of the upper basket, the following plate dimensions can be accommodated:

Example with APFD 215 Upper Basket:

Upper basket position	Upper basket plate Ø	Lower basket plate Ø
Top	Max. 5 7/8" (15 cm)	13" (33 cm)*
Bottom	Max. 7 7/8" (20 cm)	9 3/4" (25 cm)

* The E 816 Plate Insert is required in the lower basket.

Lower basket

Place larger and heavier wash items such as plates, serving platters, pots, bowls, etc. in the lower basket.

Only place thin, delicate glasses in a suitable insert or lower basket.

Always arrange plates with the top side facing inward, as shown in the pictures, to achieve the best cleaning result.

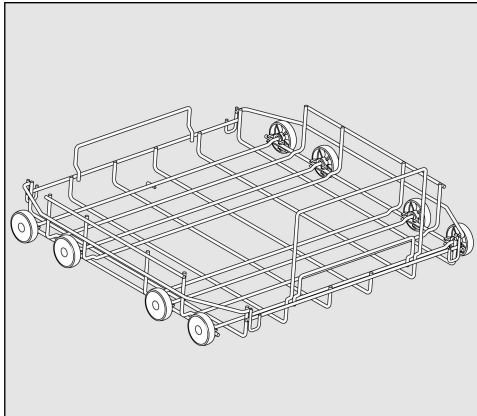

APFD 220 Lower Basket Carrier

For plastic trays, various inserts, and cutlery baskets.

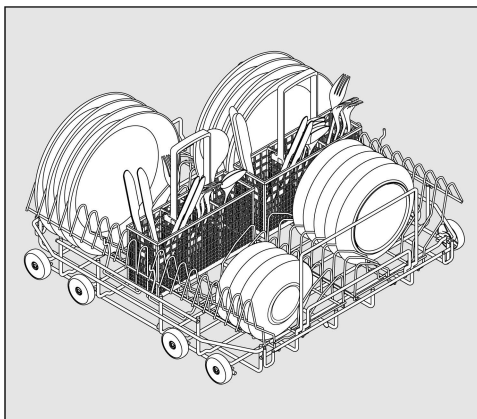

APFD 220 Lower Basket with 2 x E 816 Inserts and 2 x APFD 420 Cutlery Inserts

32 plates each with $\text{Ø } 9 \frac{3}{4}$ " (25 cm) and various items of cutlery can be loaded. Without cutlery inserts, 38 plates each with $\text{Ø } 9 \frac{3}{4}$ " (25 cm) can be loaded into the E 816 Inserts.

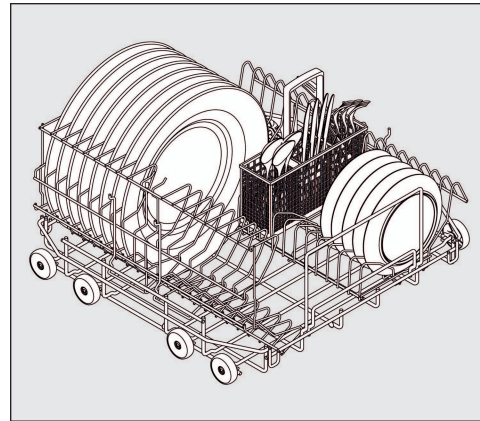

APFD 220 Lower Basket with an E 816 Insert rotated 90°

With the APFD 420 Cutlery Insert, 32 plates each with $\text{Ø } 13$ " (33 cm) and various items of cutlery can be loaded. Without the cutlery insert, 38 plates each with $\text{Ø } 13$ " (33 cm) can be loaded into the rotated E 816 Insert.

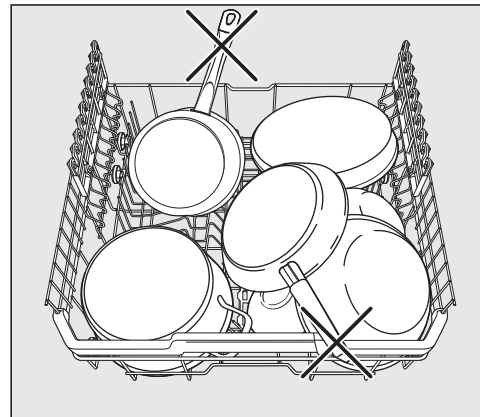

Damage due to protruding items
Protruding items can damage the interior of the dishwasher.
When loading the baskets, make sure that no parts, such as handles, are protruding over the edge of the baskets.

Loading the dishwasher

Use of plastic trays

The APFD 220 Lower Basket Carrier can be loaded with plastic trays measuring 19 3/4" x 19 3/4" (500 x 500 mm).

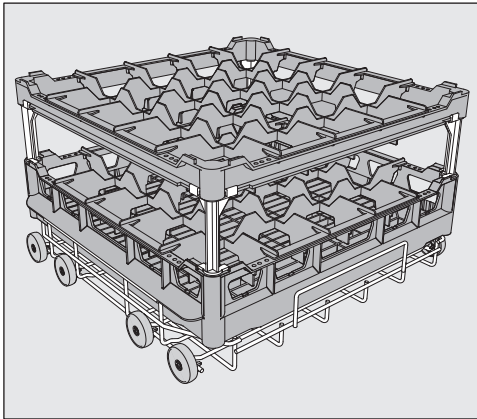

The special O 885 Upper Basket Carrier is required for loading plastic trays in the upper basket (max. loading height for wash items 5" (130 mm)).

The special U 876 Lower Basket Carrier is required for loading taller wash items in the lower basket.

Which basket combination to use will depend on the type, shape, and size of the wash items.

For further information on baskets, please contact your Miele dealer or Miele Customer Service.

Examples: (lower baskets)

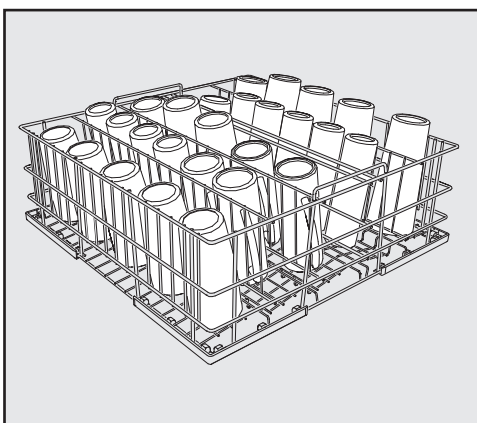

U 525/5-Row Wire Basket

The wire basket can be used for glasses with a maximum diameter of 8 cm.

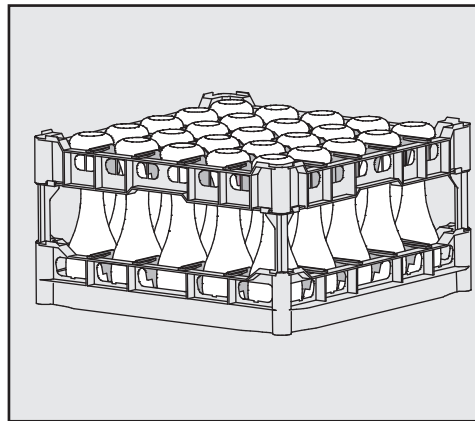

U 534–U 537 Plastic Trays with compartments for different glass heights

In this example, the plastic tray is connected to the top frame by long extenders. (For assembly in U 876 Lower Basket Carrier only)

Assembling a plastic tray

The height of the tray can be altered by installing a top frame ④ to the base basket ① with long ② or short ③ extenders.

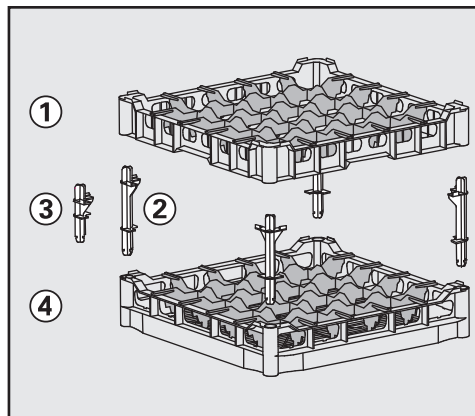

- Push all four extenders into the base basket ④.
- Press the top frame ① securely onto the extenders.



Switching on

- Switch on the water supply faucet if it is off.

The dishwasher needs to be connected to the electricity supply.

- Press and hold the  button until the following appears on the display:



As soon as the dishwasher is ready for operation, the display message changes to show the program selection screen, e.g.:

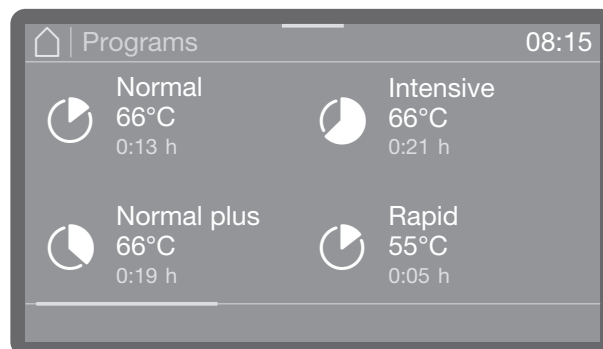

If the Memory function is activated, the most recently started program is displayed, e.g.:

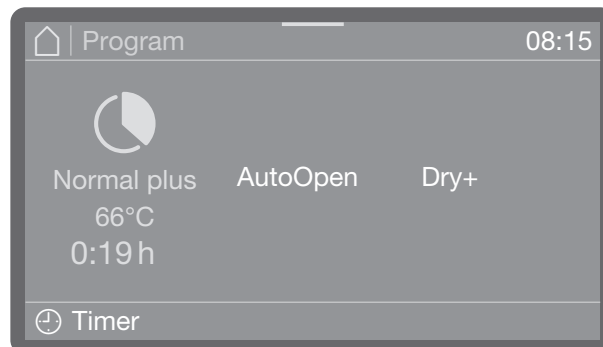

Operation

Selecting a program

Choose your program according to the type of wash items and the degree of soiling.

As soon as you have selected a program, the LED for the *Start/Stop* button starts to flash.

Use the ↵ button to return to the program selection screen before the program starts, e.g., to select a different program. This is no longer possible once the program has started. If necessary, you must cancel the program (see “Canceling a program”).

Starting a program

- Press the *Start/Stop* button (the LED of the *Start/Stop* button will light up).

Once it has been started, a program can no longer be changed.

You can interrupt (see “Interrupting a program”) or cancel (see “Canceling a program”) the program in progress.

Starting the program using a timer

The start of a program can be delayed; for example, to benefit from economy rates of electricity at night. You can set a start time at which the program should start (*Start at*) or a finish time by which the program should end at the latest (*Finish at*). The times are set based on the set time of day; see “Time of day”.

Setting the timer

- Select a program.

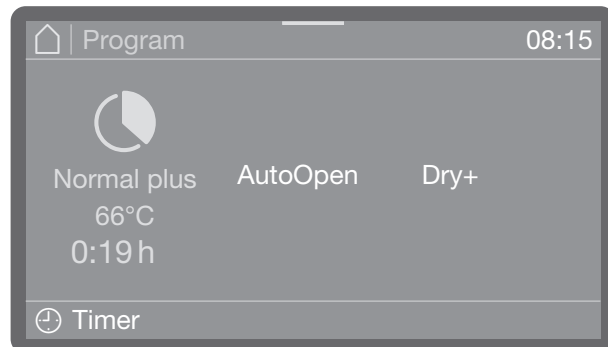

- Tap on ⌚ Timer to set the timer.

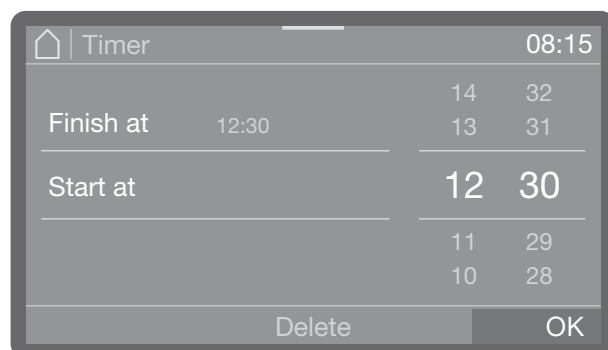

- Then select the start (*Start at*) or finish time (*Finish at*).
- Set the time.
- Confirm your entries with the OK button.

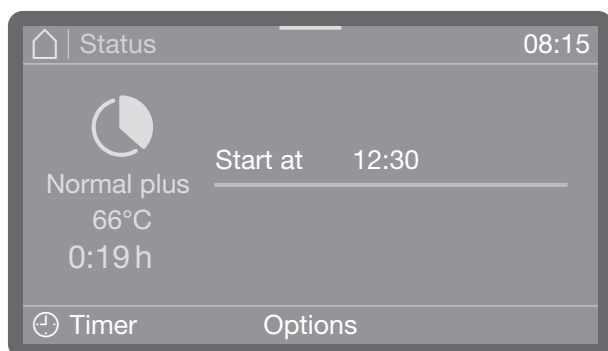

This activates the timer.

Selecting **Delete** allows you to delete the entries and deactivate the timer.

You can add or switch off functions such as **AutoOpen** or **Dry+** for the next program via **Extras** (depending on the model).

Changing the timer

- If you want to change the time set for the timer, tap on **⌚ Timer** and enter the start or finish time.

Deleting the timer

- Press the **Start/Stop** button.

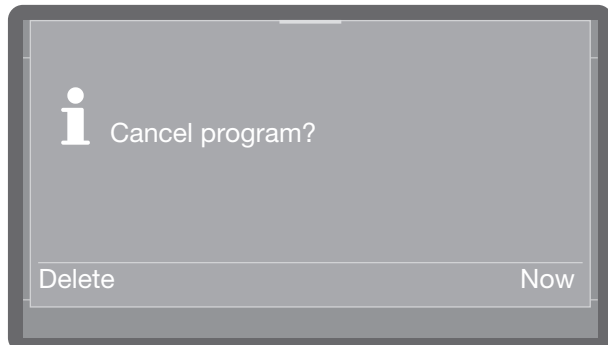

You will then be asked whether you want to start the program immediately (**Now**) or whether you want to delete the timer settings (**Delete**).

Alternatively, you can tap **⌚ Timer** again in the program view and delete the timer via the settings that follow.

Program sequence display

Once a program has started, the display shows the program name, the name of the current wash phase, and the time left until the program is finished.

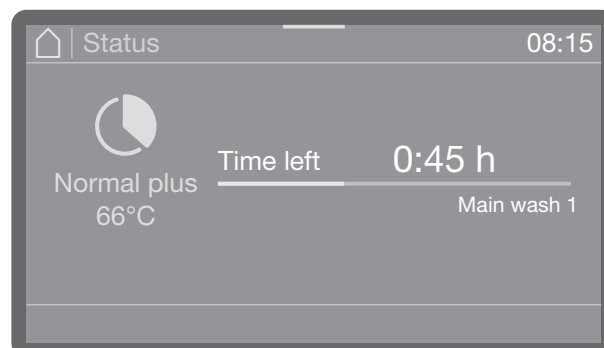

Program parameters such as the actual and target temperature can be queried during a program sequence.

- To do this, tap the colored bar in the middle of the upper edge of the display and swipe downward.

Operation

End of the program

After a program has ended normally, the LED of the Start/Stop button will go out and the following will appear on the display.

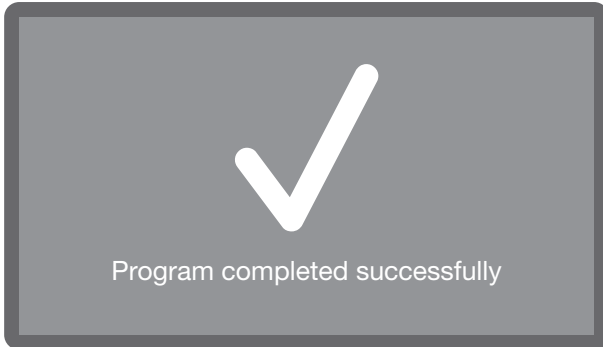

In addition to this, an audible signal will sound for approx. 3 seconds (factory default). The audible signal is repeated three times every 30 seconds. To change audible signal settings; see “Volume”.

- Tap to acknowledge the display.

If system messages are present, they are displayed afterward, e.g., if the salt container level or the level of the liquid process chemicals containers was low during the program, or when the next service is due. Every message needs to be acknowledged individually by pressing *OK*.

Switching off

- Press the  button until the display turns off.

Unloading the dishware

Dishware tends to break and chip more easily when it is hot. Allow the dishes to cool in the dishwasher until they are comfortable enough to handle before unloading them.

The dishware will cool much faster if you open the door when the program has ended.

Unload the lower basket first, and then the upper basket. This will prevent water drops from the upper basket from falling onto the dishware in the lower basket.

Interrupting a program

A program which is already running should only be interrupted if strictly necessary, e.g., if the wash items are moving significantly.

 Danger of scalding, burning, and chemical burns

The wash items, the load carrier, and the interior of the wash cabinet may be very hot.

Steam may also escape when the door is opened. Depending on the wash phase, process chemicals may be dissolved within the steam, which can cause irritation and burns in the eyes and respiratory tract.

A program should only be interrupted if strictly necessary.

Open the door slowly and carefully and avoid contact with the steam that may escape. Touch the wash items at your own risk.

- Open the door (see “Opening and closing the door”).

If the temperature in the wash cabinet is more than 153°F (67°C), the following message alerts you to possible dangers when opening the door.

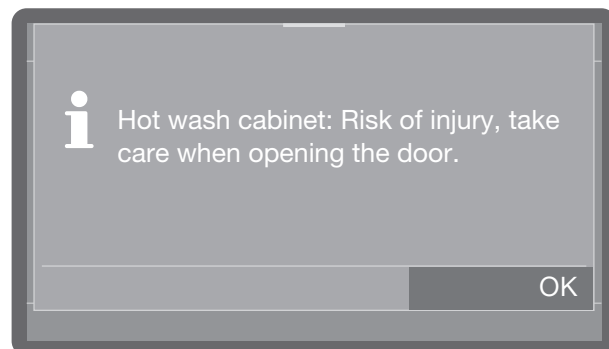

- Confirm the message with *OK*.
- Rearrange the wash items so that they are stable.

After the door is closed, the following message will appear in the display: Press “Start” to continue.

- Press the Start button to continue the program.

The program automatically continues from the point at which the interruption occurred.

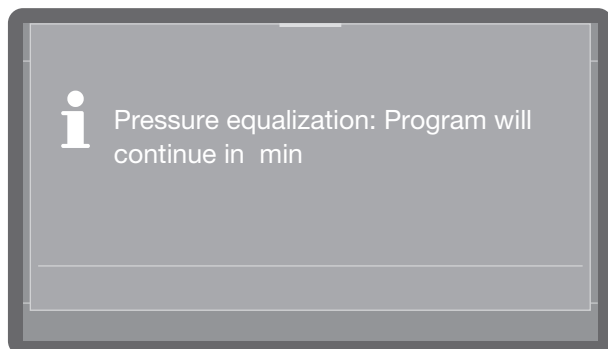

If the temperature inside the wash cabinet is more than 120°F (50°C) at this point, the pressure is equalized first. Then the program continues.

Canceling a program

Only cancel a program which has already started if strictly necessary, e.g., if you want to change the program.

In the event of a fault, the program will be canceled automatically.

Risk of scalding and burning due to hot wash items.

The wash items and the wash cabinet may be very hot.

Open the door slowly, taking care not to touch the wash items or the interior cabinet.

- Press the *Start/Stop* button.

The following will appear in the display:

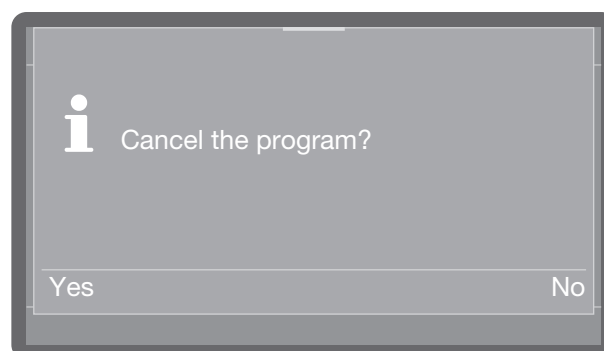

- Select *Yes* and confirm your choice with the *OK* button.

The program will only be canceled when *Yes* is confirmed.

The following message will appear in the display:

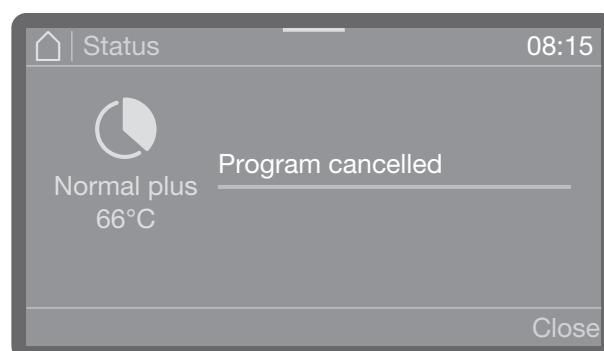

The door needs to be opened.

If you change the program and the cleaning agent dispenser flap has already opened, add more cleaning agent as needed.

Machine functions

The  Machine functions menu includes relevant functions to support daily routine tasks.

The factory settings are indicated by a tick ✓. A description of how to configure settings is provided after the overview.

Menu structure

Machine functions

Filter interval^{*)}

 Filter interval

 Reset interval

Dispensing systems^{*)}

 Fill dispensing paths

 Cleaning agent canister

 Rinse aid canister

 Rinse dispensing paths

 Cleaning agent canister

 Rinse aid canister

Dry+^{*)}

 Program selection

 All programs ✓

 Selection

 Extend Dry+ time

 Selection

AutoOpen^{*)}

 On ✓

 Off

AutoClose^{*)}

 On ✓

 Off

^{*)} Depending on the model

Filter interval

The air filters for active drying inside the machine have a limited service life. For this reason, the filters must be replaced regularly.

For more information on replacing the filter; see “Cleaning and care/Changing the filter”.

You can use the following menu to display the remaining life of the filter and to reset the counter after changing the filter.

The menu is saved under the following input path.

 Machine functions

 Filter interval*)

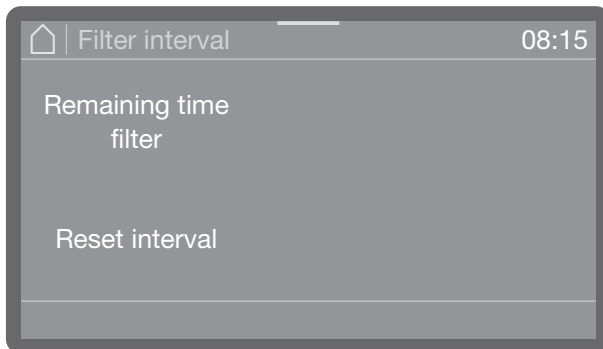

- Remaining time filter

The time remaining before the filter will need to be changed.

- Reset interval

Resets the number of operating hours before the filter will need to be changed.

- Select an option.

 The interval must only be reset when the filter has been changed.

Dispensing paths

The dispensing systems for liquid media can only dispense reliably if the dispensing system has been purged of air and contains no deposits.

Filling dispensing paths

The dispensing systems need to be topped up in the following situations:

- If the dispensing system is being used for the first time.
- If air has been sucked in or the system has been drained due to a lack of liquid media.

Before filling the dispensing paths, make sure that the containers are full and that the suction wands are screwed securely to the containers and that they cannot suck in air.

The menu is saved under the following input path.

 Machine functions

 Dispensing systems

 Fill dispensing paths

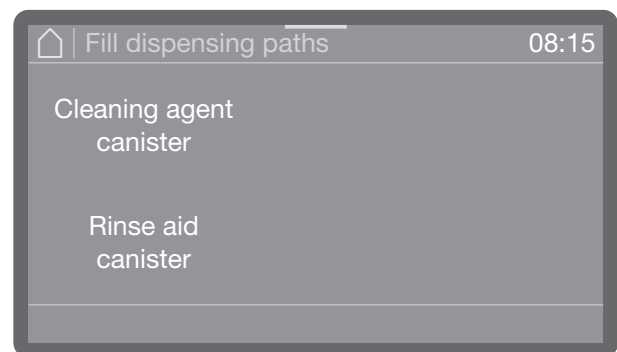

- Cleaning agent canister

Fill the cleaning agent dispensing system.

- Rinse aid canister

Fill the rinsing agent dispensing system.

- Select the dispensing system that you want to fill.

Machine functions

You will then be asked if you want to start the filling process, e.g.:

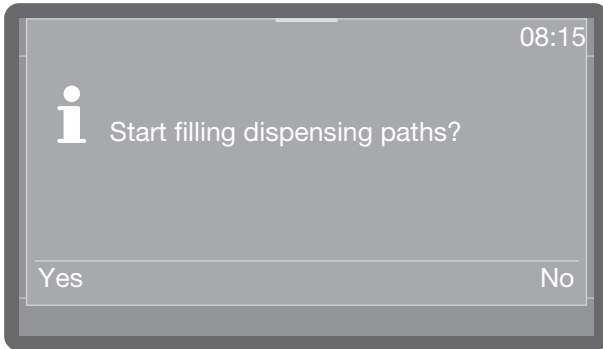

- Select Yes to start the process. The dispensing system is filled automatically. The message Filling of dispensing paths completed is displayed following successful completion. If filling is interrupted prematurely, the process must be repeated.
- Cancel the process at this point by selecting No.

Rinsing dispensing paths

A dispensing system must be rinsed in the following situations:

- If a dispensing system was accidentally filled with the wrong medium.
- If deposits have formed in the dispensing paths or in the containers, which could completely or partially clog the systems. Deposits can form, for example, after long periods of downtime or when the containers are refilled instead of being replaced.
- Fill a clean container, e.g., a bucket, with clear, clean water.

 **Damage to the dispensing system.** Small foreign objects in the water, such as sand, lint, or similar, can be sucked in by the dispensing system and may clog or damage it. Make sure that there are no foreign objects in the water.

- Place the suction wand in the container with the water. The lower end of the suction wand with the suction opening must be thoroughly rinsed.
- Secure the suction wand so that it cannot tip over or fall out of the container.

The menu is saved under the following input path.

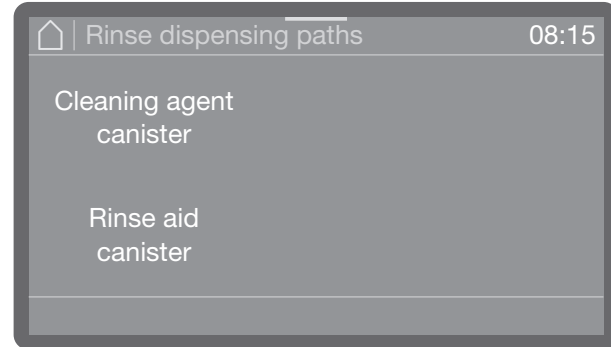
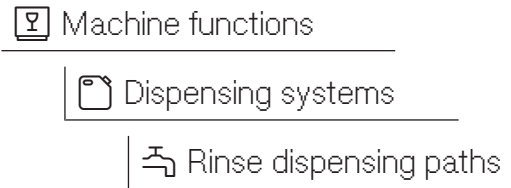

- Cleaning agent canister
Rinse the cleaning agent dispensing system.
- Rinse aid canister
Rinse the rinsing agent dispensing system.
- Select the dispensing system that you want to rinse.

You will then be asked if you want to start the process, e.g.:

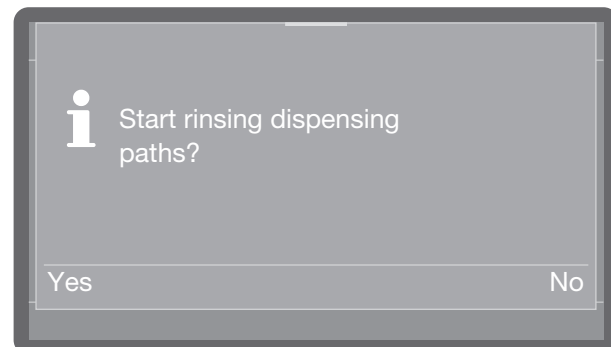

- Select Yes to start the process. The dispensing system is rinsed automatically. The message Rinse dispensing paths completed is displayed following successful completion. If rinsing is interrupted prematurely, the process must be repeated.
- Cancel the process at this point by selecting No.

Dry+

Dry+ active drying is only available on dishwashers with a drying fan (depending on the model).

Dry+ active drying accelerates and improves the drying process at the end of the program. When the door is closed, a fan conveys filtered fresh air into the wash cabinet for active drying.

You can subsequently activate or deactivate active drying for all programs that support Dry+, as well as extend the fan cycle time and in turn adjust the drying phase for individual programs. You can find out which programs support Dry+ in “Program parameters”.

Program selection

The menu is saved under the following input path.

 Machine functions

 Dry+

 Program selection

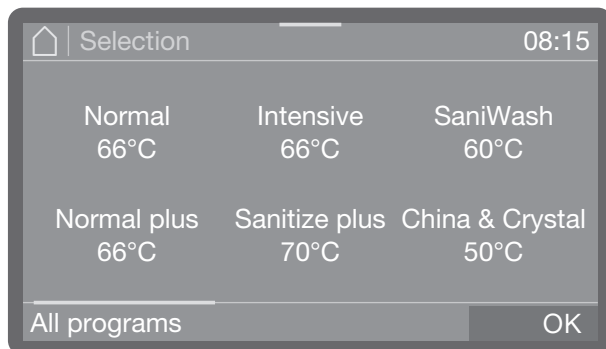

- Select the programs for which you want to activate Dry+. Activated programs are highlighted in color.
- If you want to activate Dry+ for all programs, tap on All programs.
- Press OK to save the selection.

Extension

The fan cycle time is preset for each program and it is only possible to extend this cycle time or to cancel an extension. It is not possible at this point in time to shorten the preset cycle time or to switch off the fan.

The menu is saved under the following input path.

 Machine functions

 Dry+

 Extend Dry+ time

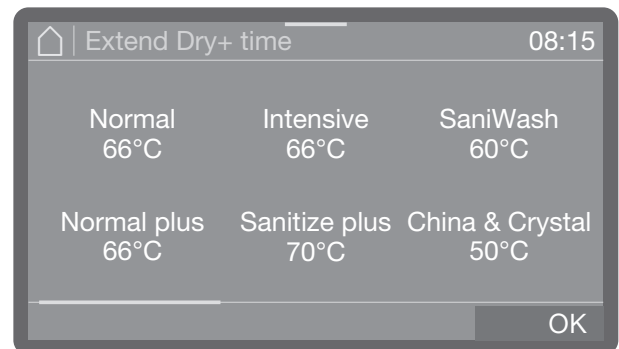

- Scroll through the program list and select the program for which you want to extend the fan cycle time.

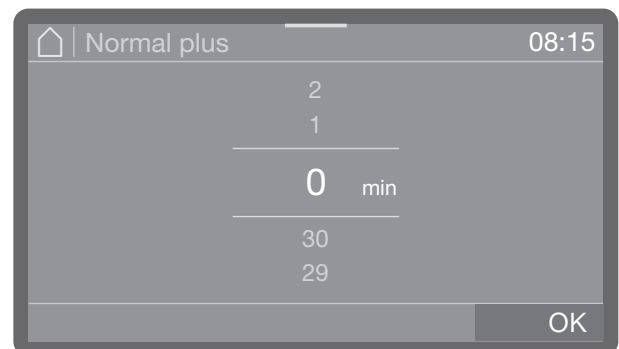

The program cycle time can be extended by up to 30 minutes in 1-minute increments.

- Set the program cycle time. In the lowest setting, the program cycle time corresponds to the preset baseline value.
- Press OK to save the setting.

Machine functions



AutoOpen

AutoOpen is an additional assisted drying function. At the end of the program, the door opens slightly to allow residual moisture to escape from the wash cabinet more quickly.

The door is opened as soon as the temperature in the wash cabinet has dropped below a certain value. Before the door is opened, a corresponding message is shown on the display and an audible signal sounds if audible signals are activated.

You can find out which programs support this function in the “Program overview”.

The menu is saved under the following input path.

 Machine functions
└─  AutoOpen

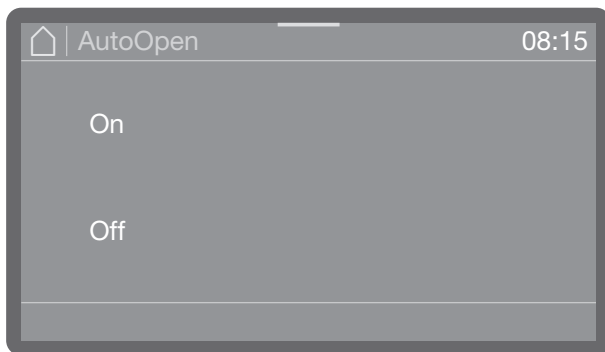



- On
AutoOpen is activated for all programs.
 - Off
AutoOpen is deactivated for all programs.
- Select an option.

AutoClose

This can be used to determine whether the door should be drawn into the final closed position by the automatic door lock immediately after closing or whether it should remain slightly open.

In its final closed position, the door is mechanically locked and can be unlocked and opened again by pressing the door button .

The menu is saved under the following input path.

 Machine functions
└─  AutoClose

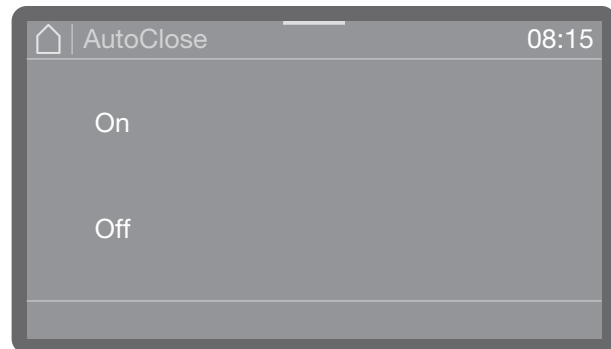

- On
AutoClose is activated for all programs. The door is drawn into the final closed position and locked immediately after closing.
 - Off
AutoClose is deactivated for all programs. The door hooks into the latch and can be pulled open again without pressing the  button.
- Select an option.

Basic parameters for machine control are stored in the  Settings menu.

The factory settings are indicated by a tick ✓. A description of how to configure settings is provided after the overview.

Menu structure

Settings

Time

Clock format

 12 h

 24 h ✓

Set time

Date

Date format

 DD/MM/YYYY ✓

 MM/DD/YYYY

 YYYY/MM/DD

Set date

Display brightness

Volume

Buzzer tones

Keypad tone

Welcome Melody

 On ✓

 Off

Temperature unit

 °C ✓

 °F

Time of day

The time of day is required for the display and the delay start, for example. The date format and the current time of day have to be set.

There is no automatic adjustment between daylight savings and standard time. You need to make this adjustment yourself as necessary.

Selecting the clock format

The menu is saved under the following input path.

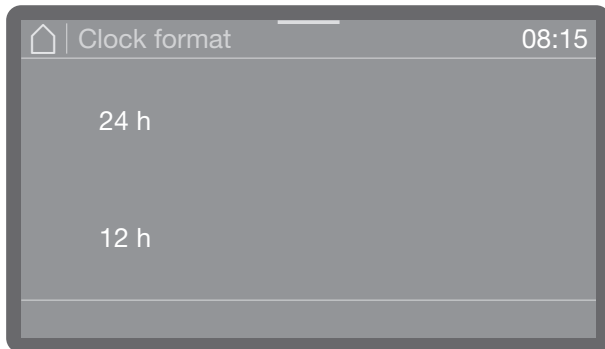
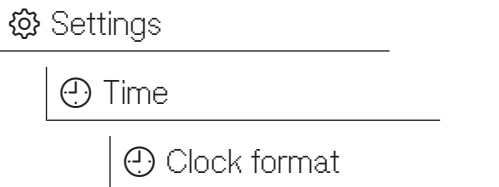

- 24 h
Time of day display in 24-hour format.
- 12 h
Time of day display in 12-hour format (am/pm).

■ Tap to select a format.

Setting the clock

To set the format for the time of day:

The menu is saved under the following input path.

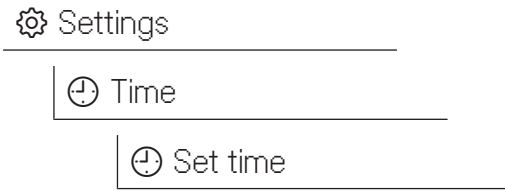

The time of day is set in the set time of day format.

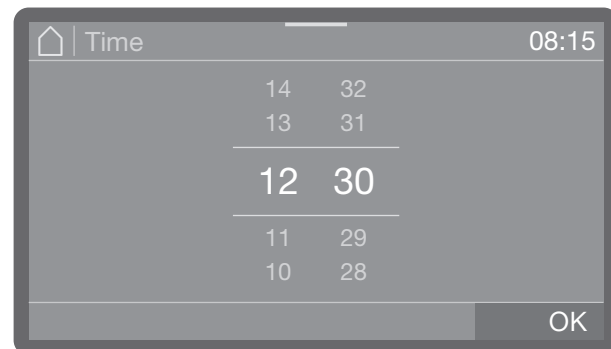

■ Set the time of day and confirm your selection with the OK button.

Date

The date format and the current date have to be set.

Selecting the date format

The menu is saved under the following input path.

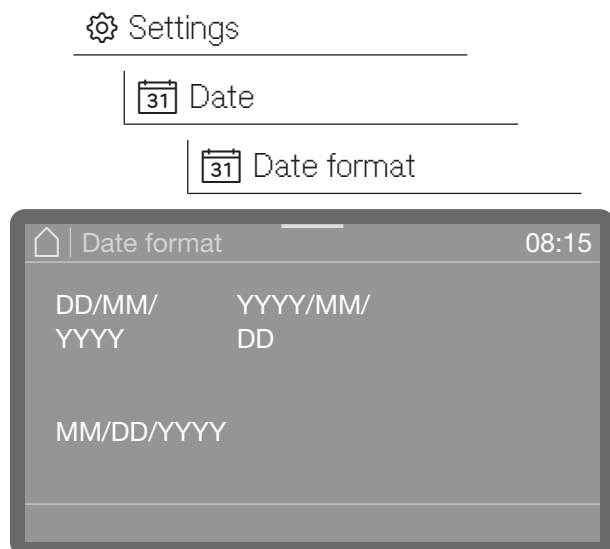

- DD is the day (D = day)
- MM is the month (M = month)
- YYYY is the year (Y = year)
- Select the format you want.

Setting the date

The menu is saved under the following input path.

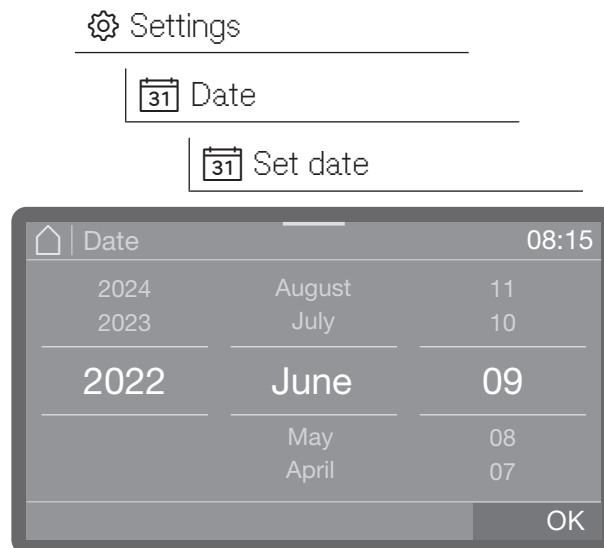

- Set the date. The order of year, month, and day is the same regardless of the date format set.
- Press OK to save the setting.

Display brightness

You can also set the brightness of the display.

The menu is saved under the following input path.



- Adjust the brightness of the display and save the setting by pressing **OK**.

Volume

An acoustic signal transmitter is integrated in the control panel, which can provide acoustic feedback in the following situations:

- Keypad tone when operating the buttons
- Buzzer tone at the end of the program or for system messages (notifications)

The menu is saved under the following input path.

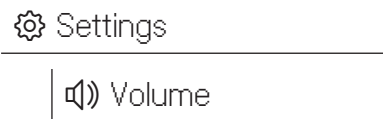

The volume for the Keypad tone and the Buzzer tone is always set in the same way.

- Select one of the options Keypad tone or Buzzer tone.

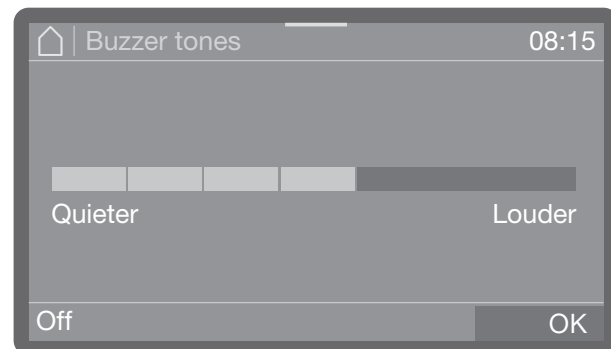

- Set the volume. In the lowest setting, the sound is switched off and can be switched back on again if required by selecting **On** (displayed instead of **Off**).
- Press **OK** to save the setting.

Welcome tone

There is a brief melody when the machine is switched on and off. You can use this option to switch this melody off and back on again.

The menu is saved under the following input path.

 Settings

 Welcome Melody

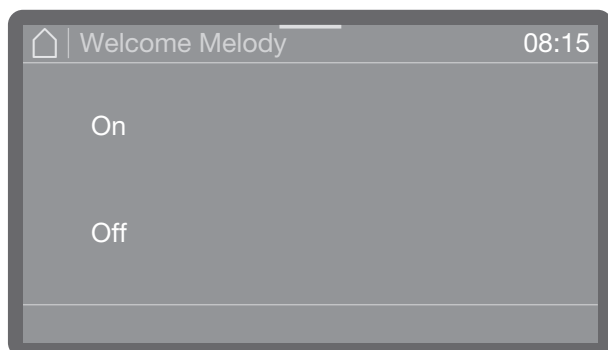

- On

A welcome melody is played when the machine is switched on.

- Off

The melody is switched off.

■ Select an option.

Temperature unit

The temperature can be shown on the display in °C (degrees Celsius) or °F (degrees Fahrenheit).

The menu is saved under the following input path.

 Settings

 Temperature unit

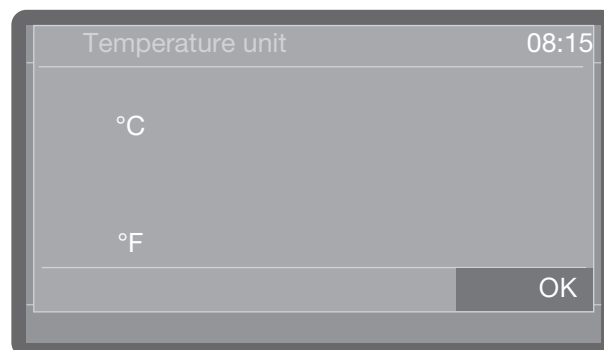

- °C

Temperature display in Celsius.

- °F

Temperature display in Fahrenheit.

■ Tap to select the option you want.

Additional settings

The  Additional settings menu incorporates all administrative processes and settings.

Access to the  Additional settings menu is protected by a PIN code.

You must enter the correct PIN code to open the menu.

Menu structure

Extended settings

Program lock filter

On

Off ✓

Standby/Off

Standby after 10 min

Off after 10 min

Log book

Water

Consumption cold water

Consumption hot water

Liquid clean. agent

Rinse aid

Operating hours

Program cycles

Service interval

Release programs

All programs ✓

Selection

Set Favorites

Configure programs

 [Program name]

 Cleaning temperature

 Main wash holding time

 Final rinse temperature

 Final rinse holding time

 Increased water quantity

 Interim rinse

 Increased water quantity

 Reset

Ao Display A0 value ^{*)}

Ao Off ✓

Ao On

 Dispensing systems

 Cleaning agent door

 Rinse aid door

 Refill indicator

 On ✓

 Off

 Dispens. concentration

 Cleaning agent canister

 Dispens. concentration

 Dispens. concentration

 Dispens. concentration

 Deactivate ✓

 Rinse aid canister

 Dispens. concentration

 Dispens. concentration

 Dispens. concentration

 Deactivate ✓

 Cycles until empty

 Water hardness

 2.5 mmol/l (14°dh) ✓

 Cycles bef. reactivation

 1

 Memory

 On ✓

 Off

 PIN code

 Change PIN code

 Door lock code

 Yes

 No

Additional settings

 Network/WiFi

 Set up

 Via WPS

 Via Soft AP

 Activate

 Deactivate

 Connection status

 Set up again

 Reset

 RemoteUpdate

 On

 Off ✓

 Dealer

 Demo mode

 On

 Off ✓

 Software version

 1-SBAE ID XXXX

 2-EL ID XXXX

 3-EFU ID XXXX

 5-LG ID XXXX

Data plate

 Factory default

 Program settings only

 All settings

 Legal Information

*) Depending on the model

Filter program lock

The filter combination in the wash cabinet filters coarse dirt particles out of the wash water. If dirt particles enter the circulation system, they may clog the spray arms, valves, etc.

It is possible to stop the program from starting if the micro-fine filter has been inserted incorrectly or is missing.

The menu is saved under the following input path.

 Extended settings

 Program lock filter

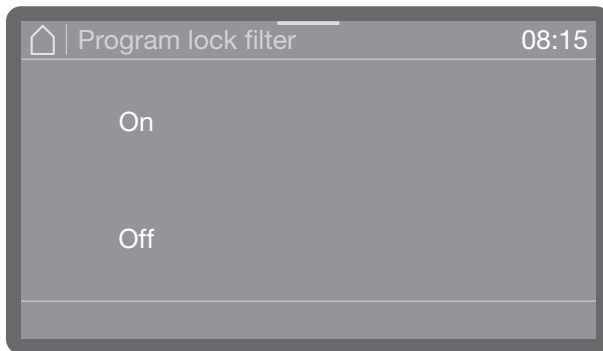

- On

Programs are prevented from starting if the micro-fine filter has been inserted incorrectly or is missing.

A program can only be started when the micro-fine filter is inserted correctly.

- Off

Programs can be started regardless of the status of the micro-fine filter. A confirmation prompt is displayed, which must be confirmed if the micro-fine filter is not inserted correctly.

■ Select an option.

Standby/Off

If the dishwasher has not been used for 10 minutes, it can be set to standby or switched off automatically.

In standby mode, the dishwasher remains switched on and the *Start/Stop* button flashes. The dishwasher can be reactivated by pressing the *Start/Stop* button, touching the display, or opening the door.

After automatic switch-off, the dishwasher is switched off and can be switched on again by pressing the  button.

The menu is saved under the following input path.

 Extended settings

 Standby/Off

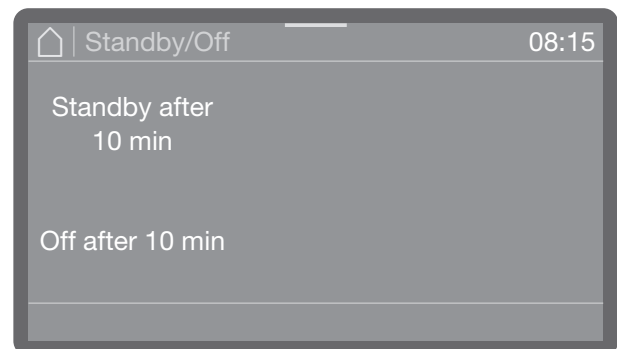

- Standby/Off

Switch to standby mode after 10 minutes

- Off after 10 min

Switch off after 10 minutes.

■ Select an option.

Additional settings

Log book

The consumption data for water and process chemicals as well as the operating hours and program sequences are logged in the log book. The entire life cycle of the machine is recorded.

Miele Customer Service can also use the log book to calculate a recommendation for service intervals.

The menu is saved under the following input path.

 Extended settings

 Log book

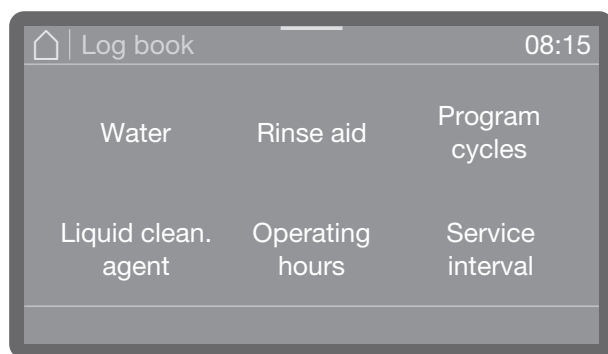

- Water

Display of water consumption in liters (l)
If there are several water connections (depending on the model), the consumption is displayed according to the water type.

- Liquid cleaning agent

Consumption of liquid cleaning agent in liters (l)

- Rinsing agent

Consumption of rinsing agent in liters (l)

- Operating hours

Number of operating hours

- Program sequences

Total of all program sequences.
The display can be broken down by program.

- Service interval

Reminder about the next service. The date of the next service is entered by Miele Customer Service.

■ Scroll to the option you want using the \wedge and \vee arrow buttons and select it by tapping on it.

The values in the log book cannot be changed.

■ Press the \leftarrow button to exit the menu.

Program release

There is an option to block individual programs. Blocked programs are no longer available in the program selection screen. This ensures, for example, that only programs suitable for the wash items are used.

The menu is saved under the following input path.

 Extended settings

 Release programs

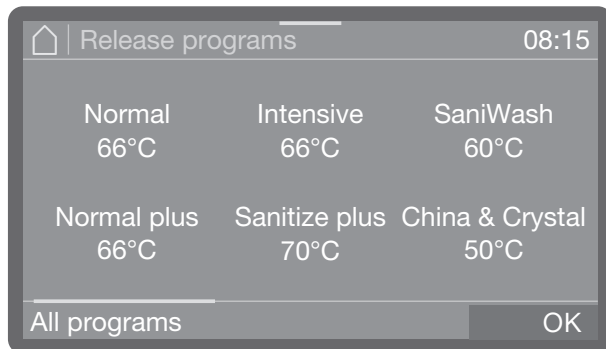

- Scroll through the program list and select the programs that you want to make available to users. Multiple selection is possible. Activated programs are highlighted in color.
- Press **All programs** to select all programs at once.
- Press **OK** to save the selection.

Set Favorites

Under Favorite programs, you can define the order of the programs and choose which programs should be immediately accessible in the program selection screen. You can choose from all the programs available under **Approved programs**.

The menu is saved under the following input path.

 Extended settings

 Set Favorites

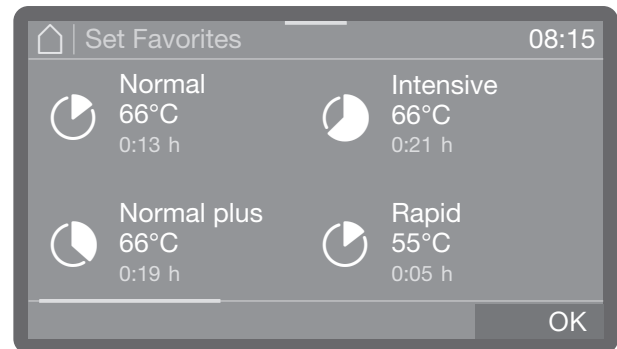

The program overview appears on the display.

- Select a program by tapping and holding it until a frame appears around the program.
- Drag the program to the required position and remove your finger from the display.

The frame around the program disappears and the program remains in the required position.

- Press **OK** to save the setting.

Additional settings

Program parameters

The program parameters should be adjusted to suit technical requirements and the wash items.

Additional specialist knowledge about the machine and its processes is required to modify program parameters and this should therefore be undertaken only by experienced users or by Miele Customer Service.

- Start by selecting the program you want to change.

Selecting a program

The menu is saved under the following input path.

 Extended settings

 Configure programs

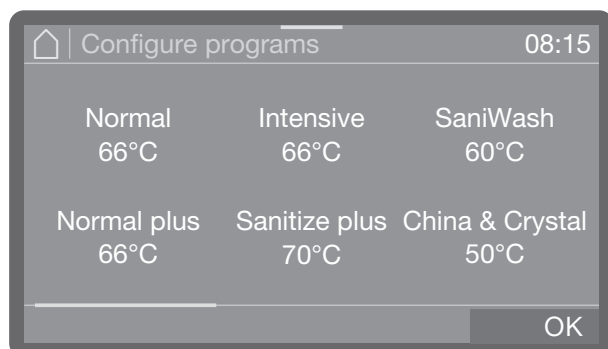

- Scroll through the program list and select the program that you want to change.

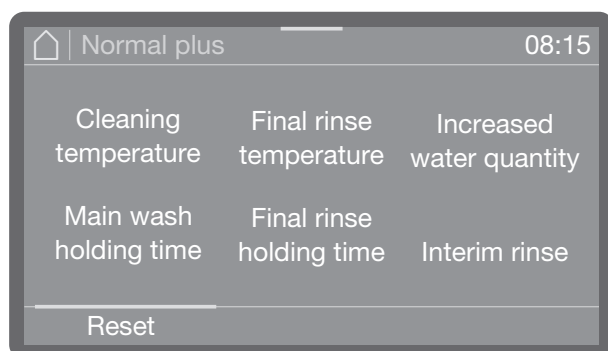

- Select a program parameter that you want to change.

Wash temperature

The wash temperature is reached by heating up the wash water. The temperature needs to be adjusted to the task.

Dispensing of process chemicals occurs at a default dispensing temperature set at the factory.

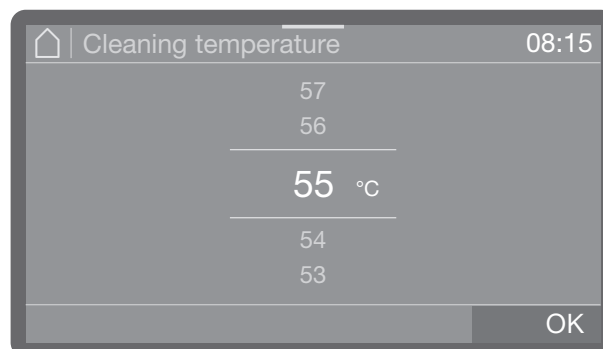

- Set the temperature. The adjustment range varies depending on the model and program.
- Press OK to save the setting.

Main wash holding time

The holding time is a period during which the temperature in the wash block is kept constant.

In the case of the Rapid program, the holding time is entered in seconds and can be adjusted in 5-second increments.

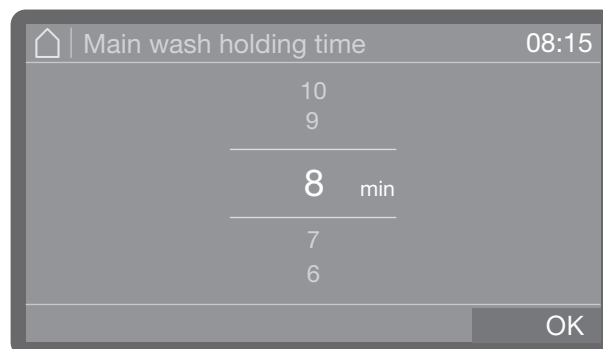

- Set the holding time.
- Press OK to save the setting.

Final rinse temperature

The final rinse temperature is reached by heating up the wash water. The temperature needs to be adjusted to the task.

This menu option is not available on dishwashers with Dry+ drying.

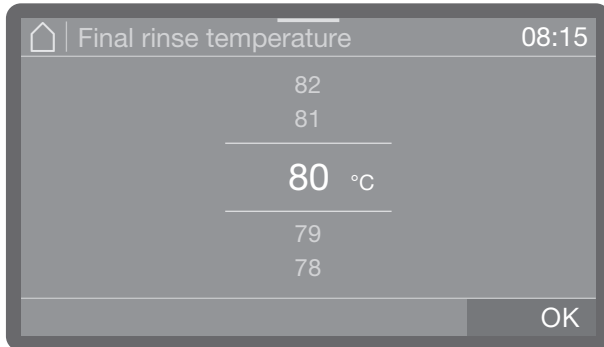

- Set the temperature. The adjustment range varies depending on the model and program.
- Press **OK** to save the setting.

Final rinse holding time

The holding time is a period during which the temperature in the wash block is kept constant.

In the case of the Rapid program, the holding time is entered in seconds and can be adjusted in 5-second increments.

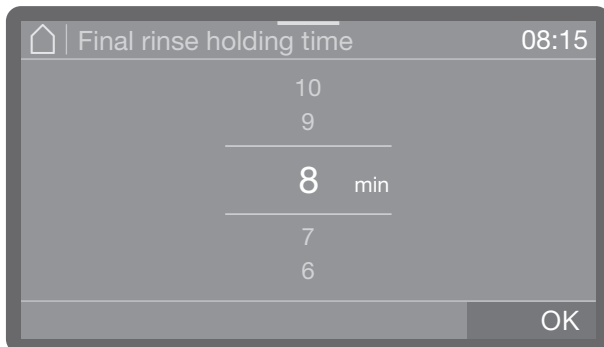

- Set the holding time.
- Press **OK** to save the setting.

Increased water level

It is then advisable to increase the water level when a lot of water is absorbed due to the structure of the wash items or when the type of soiling and the process chemicals used lead to excess foam development. The additional volume of water depends on the type of basket or mobile unit used, the type of soiling, and the wash items.

If slightly soiled wash items which absorb a little water are being reprocessed, the water level can be reset to the factory default to save water and energy.

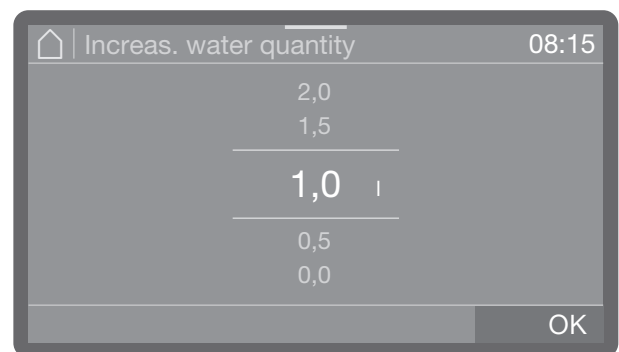

- Set the additional volume of water. In the lowest setting, the volume of water corresponds to the factory default.
- Press **OK** to save the setting.



Additional settings

Changing the name

You can change a program name if required. The preceding symbol cannot be changed.

- Select the Program name option.

Names can consist of up to 15 characters including spaces. The following options are available for naming:

- Letters from A to Z; each new word will automatically start with a capital letter.
- Numbers from 0 to 9.
- Spaces _.
- Use the  symbol to delete the last entry.
- Select **Reset** to reset the program names to the factory default.
- Press the  button to end the process without saving the name change.

- Enter the name.

- Confirm your entry by pressing **OK**.

Interim rinse

If required, an additional interim rinse block can be activated for selected programs.

You can find out which programs support this function in the “Program overview”.

- On
Activates the additional interim rinse block for the selected program.
 - Off
Deactivates the additional interim rinse block.
- Tap to select an option.

Resetting parameters

You can reset individual programs to the factory default settings. The program parameters and changed program names are reset.

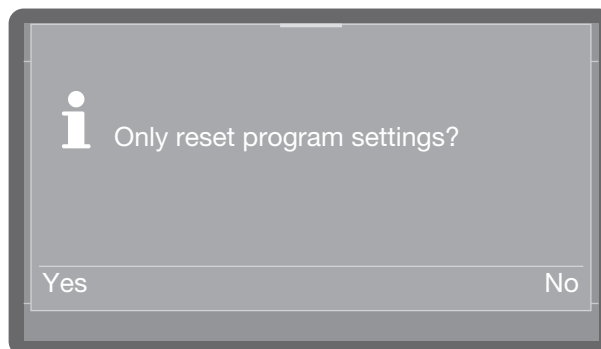

- Select **Yes** to reset the parameters and program names to the factory default settings.
- Select **No** to cancel the process.

A0 value display

The A_0 value is a standard known from medical technology for the destruction of microorganisms with moist heat (cf. ISO 15883); it is calculated from the temperature and holding time.

The information “ A_0 value” that is displayed at the end of the program in this dishwasher is calculated from the temperature in the wash chamber and the corresponding holding time. The displayed value only gives an indication, but doesn’t exactly fulfill the directive ISO 15883, as this dishwasher is not a medical device.

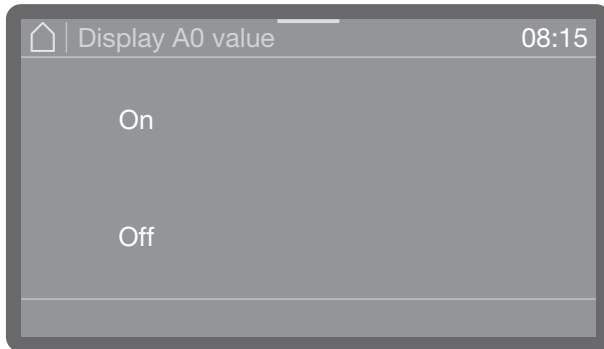

- On
A0 value measuring is switched on and the value is displayed at the end of the program
 - Off
A0 value measuring is switched off
- Select an option.

Dispensing systems

The following menu allows you to activate, fill, and rinse dispensing systems, to change their names if required, and to set the dispensing concentration for all programs.

Depending on the model, various dispensing systems are available for dispensing process chemicals.

Cleaning agent and rinsing agent can be dispensed either via a corresponding door dispenser (/// cleaning agent, * rinsing agent) or via suction wands for liquid media from an external media canister. It is not possible to activate both systems at the same time.

Selecting a dispensing system

The menu is saved under the following input path.

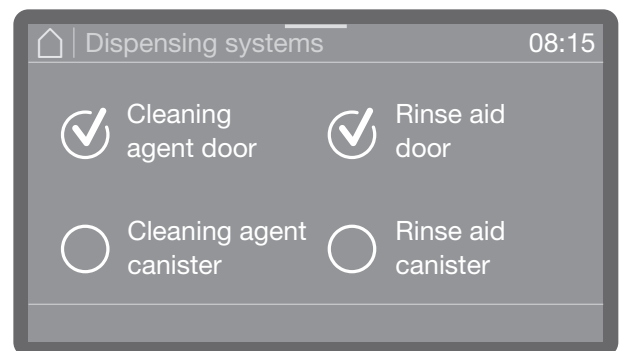
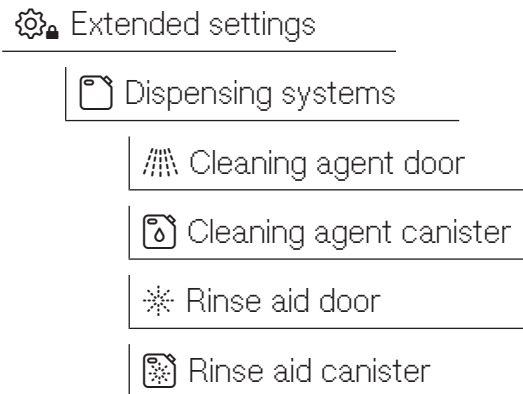

Only the available dispensing systems are displayed.

- Select a dispensing system.

Additional settings

Door dispenser

 Cleaning agent door

One of the following messages is displayed if you have selected Cleaning agent door.

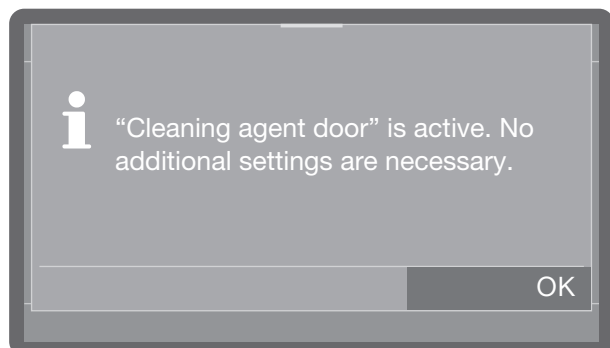

- Door dispenser is activated
- No further settings are possible. Confirm the message by pressing OK.

If you want to change dispensing to the powder dispenser, select "Cleaning agent door" and activate it, or select the Cleaning agent canister option and deactivate dispensing.

 Rinse aid door

Refill indicator

The refill indicator indicates a lack of rinsing agent in the door dispenser. If you want to stop dispensing rinsing agent via the door dispenser, you need to switch off the refill indicator.

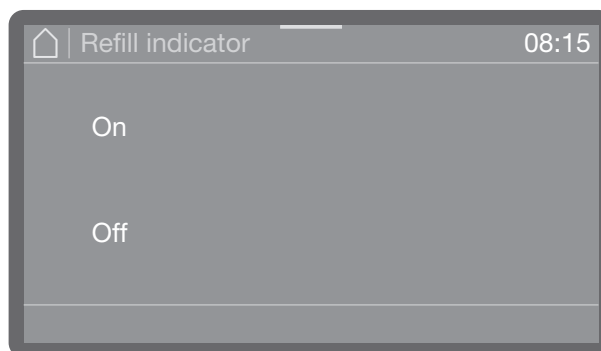

- On
 - The display indicates a lack of rinsing agent in the door dispenser.
- Off
 - The display does not indicate a lack of rinsing agent.
- Select an option.

Activating dispensing from the media canister



To activate dispensing of liquid process chemicals from external media canisters, you must proceed as follows.

- Start by selecting a dispensing system.

This selection is only available if the corresponding dispensing system is present (depending on the model).

 Cleaning agent canister

 Rinse aid canister

If a rinsing agent door dispenser  or a powder dispenser  is present and activated (depending on the model), when you select Cleaning agent canister or Rinse aid canister, you will first be asked if you want to switch to dispensing from the media canister. There is no query if dispensing from the media canister is already activated.

Deactivating dispensing from the media canister

You can subsequently switch dispensing from the media canisters to the door dispensers or deactivate it completely.

- Start by selecting a dispensing system.

This selection is only available if the corresponding dispensing system is present (depending on the model).

 Cleaning agent canister

 Deactivate ✓

 Rinse aid canister

 Deactivate ✓

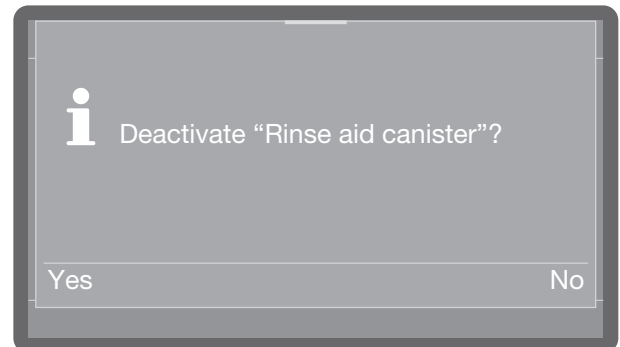
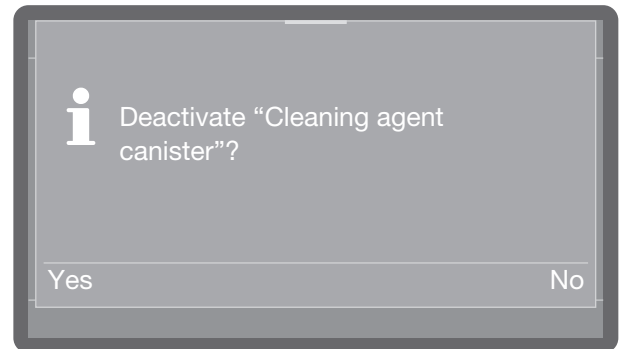

- Select OK to deactivate dispensing from the media canister. This change will take place immediately.
- If you do not want to change the setting, press the  button.

Additional settings

Dispensing concentration

The dispensing concentration for liquid process chemicals is set in the same way for all dispensing systems. The setting applies to all programs.

This selection is only available if the corresponding dispensing system is present (depending on the model).

 Rinse aid door

 Cleaning agent canister

 Rinse aid canister

- Start by selecting a dispensing system.

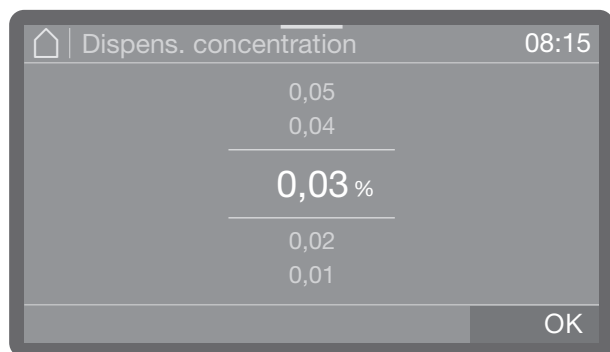

- Set the dispensing concentration.
- Press OK to save the setting.

Filling dispensing paths

See  Machine functions

Rinsing dispensing paths

See  Machine functions

Cycles until empty

When dispensing liquid process chemicals from external media canisters, the fill level in the canister is monitored. You can use the following function to set the number of program sequences (cycles) from which you want to be warned about the imminently empty media canisters. The message is displayed after switching on the machine and before every program start.

You can set the number of cycles from 0–150 cycles.

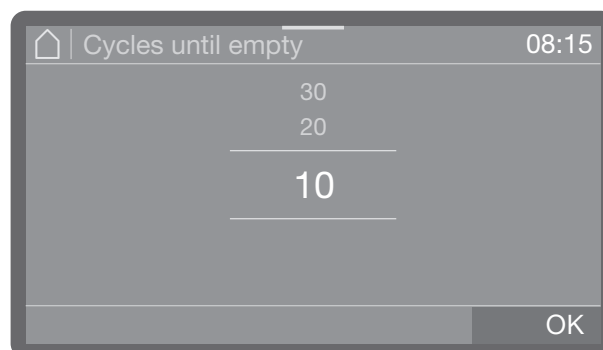

- Set the number of cycles.
- Press OK to save the setting.

Water hardness

The water hardness setting is described in “Filling the salt container”.

Reactivation notification

In order to plan wash phases more effectively, you can have the remaining number of wash cycles before the next reactivation displayed as a notification.

When the set number of cycles before the next reactivation has been reached, a notification is displayed after each completed program.

You can set the number of cycles from 0–20 cycles; at 0, no notification is displayed.

The menu is saved under the following input path.

 Extended settings

 Cycles bef. reactivation

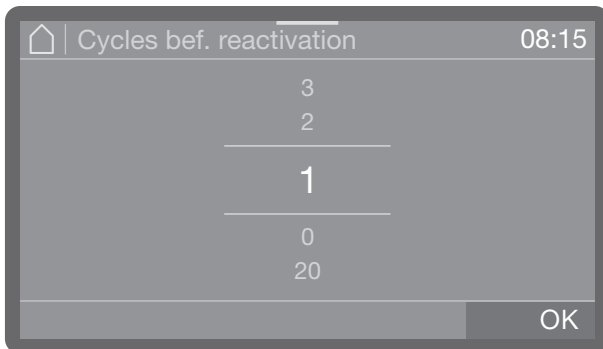

- Set the number of cycles.
- Press **OK** to save the setting.

Memory

If you are always using the same program in a continuous sequence, you can use the memory function. This automatically suggests the most recently selected program so that you can start the program immediately after loading. The program selection screen is therefore not displayed, but it is still available.

The menu is saved under the following input path.

 Extended settings

 Memory

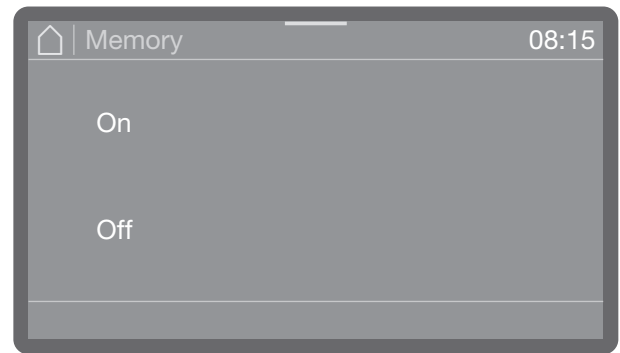

- On

The most recently selected program is pre-selected before the next program starts.

- Off

The programs need to be selected via the program selection screen.

- Select an option.

Additional settings

PIN code

Access to relevant system settings and machine functions that require advanced knowledge of the machine and its processes can be protected by PIN codes. A PIN code consists of 3 numbers from 0–9 in any order.

The factory-assigned PIN code is 800.

 If a PIN code is lost, a new code must be issued by Miele Customer Service.

Entering a PIN code

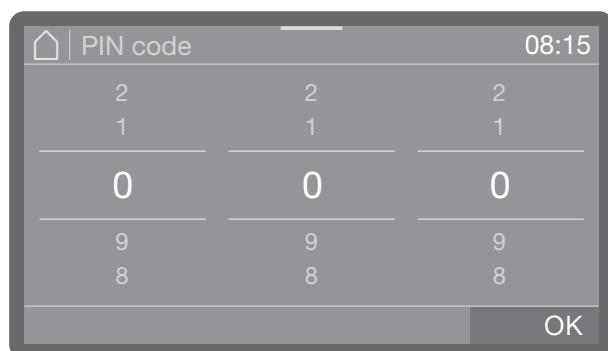

- Set the relevant numerical values and confirm your input with the OK button.

You can cancel the process at any time by pressing the  button.

If the PIN code was entered correctly, the protected area is made available for further use.

If it is entered incorrectly, a corresponding message is displayed and the process is canceled.

Blocking further settings or making them available

Access to the menu can be protected by a PIN code or can be made available to all users. A new code can also be assigned.

The menu is saved under the following input path.

 Extended settings

 PIN code

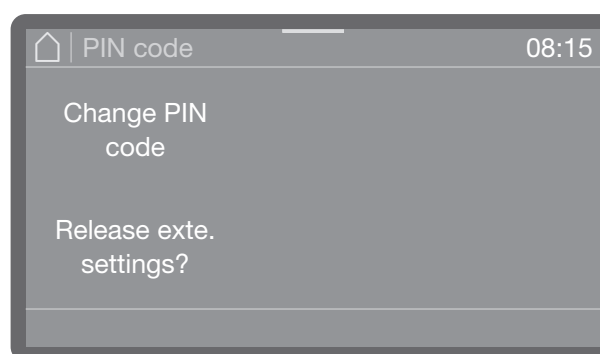

- Change PIN code

Assign a new PIN code (see “Changing a PIN code”).

- Release exte. settings?

The  Extended settings menu is available to all users.

- Select an option.

Changing the PIN code

When a new PIN code is entered, the old PIN code is overwritten and is permanently deleted. It is therefore not possible to reinstate the old code.

If a PIN code is lost, a new code must be issued by Miele Customer Service.

Assign a new PIN code by selecting the **Change PIN code** option in the menu.

- Follow the instructions on the display and start by entering the current PIN code.

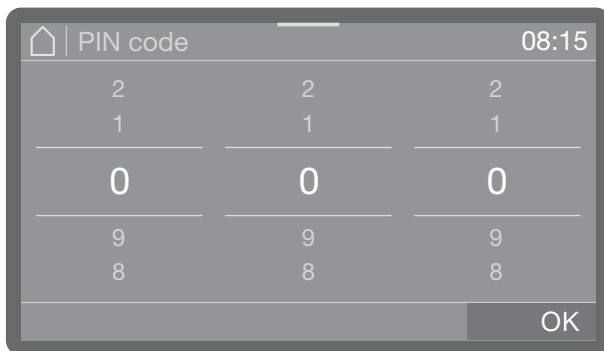

- Set the relevant numerical values and confirm your input with the **OK** button.

You can cancel the process at any time by pressing the  button.

- Then enter the new code.
- Confirm the new PIN code by entering it again.

If both entries match, the old PIN code is replaced by the new code.

If the entries do not match, a corresponding message is shown on the display and the old PIN code remains in use.

Door lock code

Opening the door during a running program results in a program interruption. Interruptions involve certain risks for the user and can impair the cleaning result, e.g., if dirty wash items are added. For this reason, a door lock can be set up that requires a PIN code to be entered if the door needs to be opened during a program.

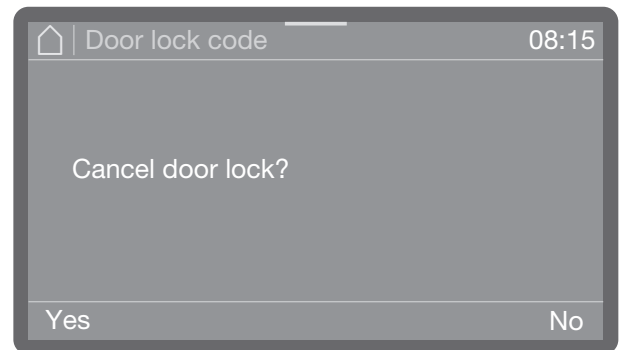

- Select **Yes**.

Activation of the door lock, which requires a PIN code to be entered if the door needs to be opened during a running program. You need to assign a new PIN code (see “Changing the PIN code”).

Or

- Cancel the process by selecting **No**. The menu disappears.

Additional settings

Networking/WiFi

Your dishwasher is equipped with an integrated WiFi module.

You can connect your dishwasher to your local network in order to use digital solutions from Miele.

Once the dishwasher is connected to your local network, more menu options are added to the “Further settings” and “Networking/WiFi” menu.

Check the settings of your WiFi router, especially when operating several machines in the WiFi network.

Make sure that your WiFi network signal strength is strong enough at the installation site of your dishwasher.

Place the dishwasher and the router at a suitable distance from each other.

The menu is saved under the following input path.

 Extended settings

 Network/WiFi

WiFi setup

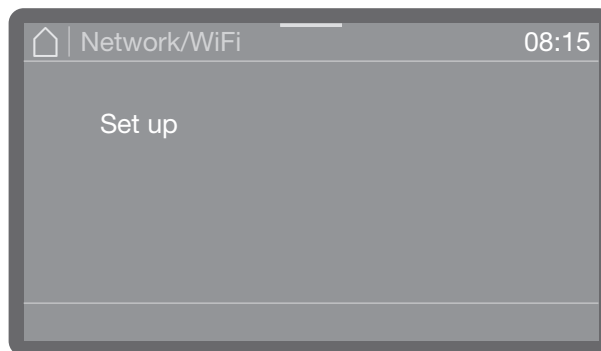

- Select the Set up menu option.

You can connect your dishwasher to your network using Via WPS or Via Soft AP.

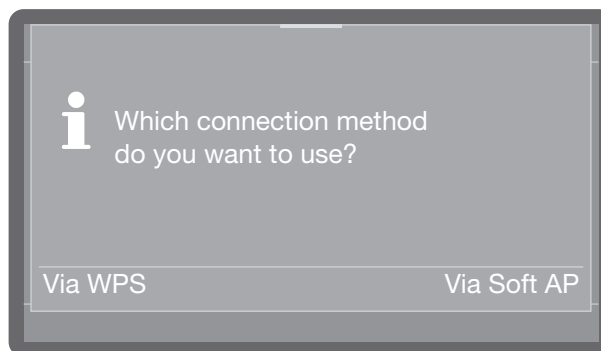

Connection via WPS

You can connect your dishwasher to your WiFi network using WPS (WiFi Protected Setup).

Your WiFi router must support WPS.

- When asked Which connection method do you want to use?, **select** WPS.

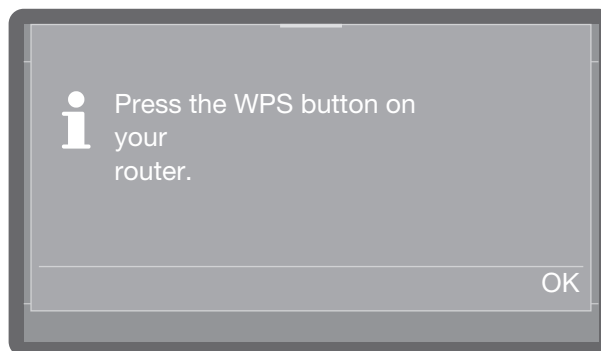

- When Press the WPS button on your router. appears on the display, activate the WPS function on your router within 2 minutes.

- Once the connection has been established, Connection established will appear on the display. Confirm the message with *OK*.

If the connection fails, you have probably not activated WPS on your router quickly enough. Repeat the steps above.

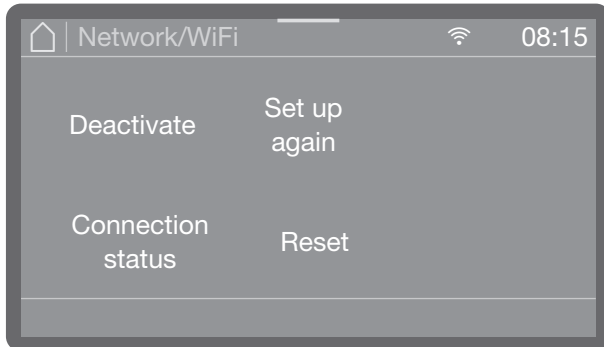

- Deactivate
The WiFi connection is deactivated but the connection options are retained. The WiFi connection can be reactivated without having to repeat the connection process.
- Connection status
Displays the IP address and the connection status of the WiFi connection.
- Set up again
Menu option for setting up a new WiFi connection.
- Reset
Resets the WiFi connection. The connection options are lost and need to be set up again.

Soft AP

If Connection via WPS is not possible, you can connect the dishwasher to your local network Via Soft AP.

A Soft-AP (Software-enabled Access Point) is a wireless access point provided by your dishwasher that can be used by other wireless machines in the vicinity.

With Soft-AP, the dishwasher is not connected to the Internet. A Soft AP is only used to connect two machines locally via WiFi.

Connecting via Soft-AP

You can connect your dishwasher to your WiFi network via a Soft-AP (Software Enabled Access Point).

- When asked Which connection method do you want to use?, select Soft AP.

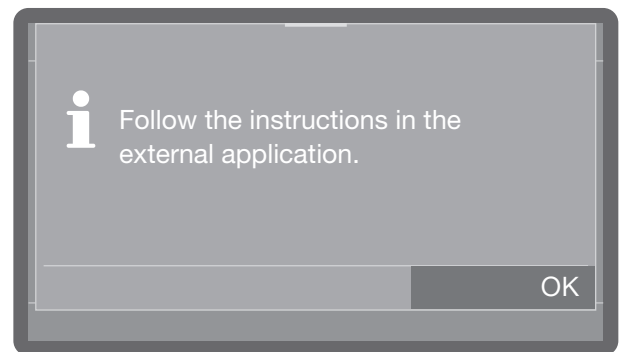

- Confirm the message by pressing *OK* and follow the instructions in the external application.

Waiting for connection will appear on the display. This message remains active for approx. 10 minutes after selection and is then closed.

- Once the connection has been established, Connection established will appear on the display.
- Confirm the message with *OK*.

Additional settings

RemoteUpdate

This menu option only appears if the dishwasher has been integrated into the WiFi network.

When a new version of the dishwasher control system is available, you can decide whether or not to automatically update it.

The menu is saved under the following input path.

 Extended settings

 RemoteUpdate

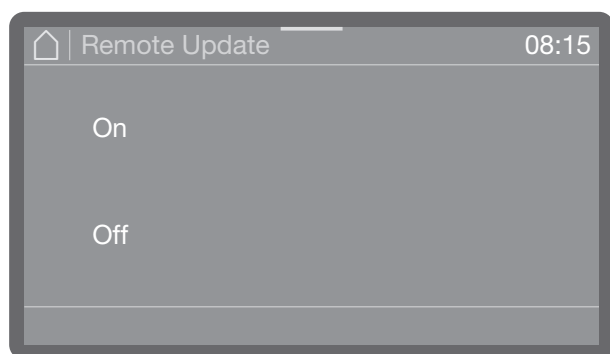

- On

The updates are displayed and can be downloaded.

- Off

Updates are ignored.

■ Select an option.

Demo mode

For dealer demonstration purposes only.

The dishwasher is equipped with a Demo mode for dealer use.

The menu is saved under the following input path.

 Extended settings

■ Dealer

Software version

Displays the versions of the individual software components.

The menu is saved under the following input path.

 Extended settings

 Software version

The relevant software version numbers appear on the display. No settings are possible.

Data plate

Display of the data plate with all important information for your dishwasher, such as the model identifier, electrical connection, etc.

The menu is saved under the following input path.

 Extended settings

Data plate

The data plate appears on the display. No settings are possible.

Factory default settings

If necessary, the modified program parameters or all dishwasher parameters can be reset to the factory default settings.

The factory default settings should only be restored in consultation with Customer Service.

The menu is saved under the following input path.

 Extended settings

 Factory default

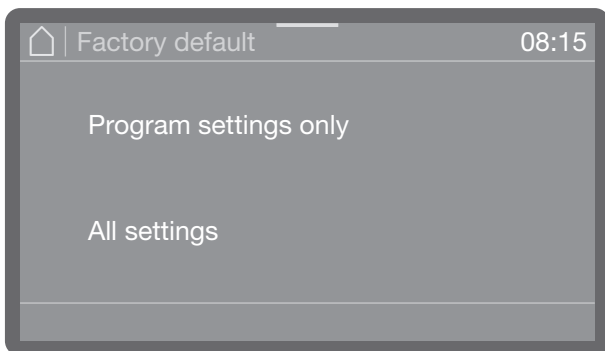

- Program settings only

The changes to the program settings are reset to the factory default settings.

- All settings

All changes are reset to the factory default settings.

- Select an option.

Depending on the option you have chosen, you will be asked whether Program settings only or All settings should be reset.

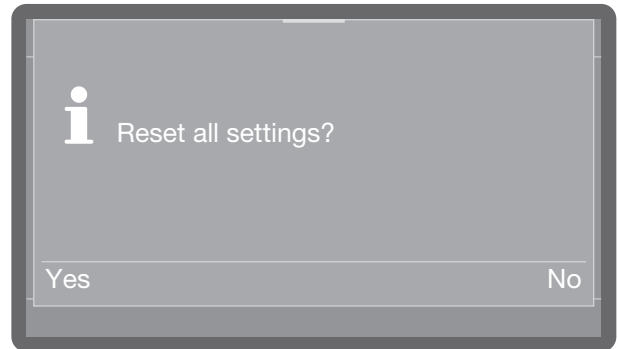
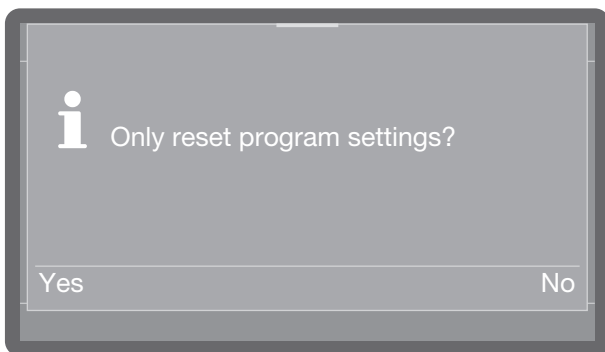

- Selecting Yes resets the program settings or all settings, depending on the option chosen.

Or:

- If you do not want to reset, select No.

Legal information

This menu contains legal information such as the imprint, information on data protection, and the terms of use.

The menu is saved under the following input path.

 Extended settings

 Legal Information

The information appears on the display. No settings are possible.

Cleaning and care

MAINTENANCE

To prolong the service life of the dishwasher, maintenance should be carried out **at least once a year** by Miele Customer Service.

This service work covers the following points:

- Door mechanism and door seal
- Screw connectors and connections in the wash cabinet
- Water intake and drainage
- Internal and external dispensing systems
- Spray arms
- Filter combination
- Collecting basin with drain pump and non-return valve
- All baskets and inserts

The following operational tests will be carried out as part of the maintenance:

- A program will be run as a test run
- Seals will be tested for water tightness
- All relevant measuring systems will be safety tested, including fault displays
- Safety features

 Soiling alters the surface.

Soiling that is left too long might become impossible to remove and could cause the external surfaces to alter or discolor. Remove any soiling from the control panel and from the front of the machine straight away.

 All surfaces are susceptible to scratching.

Contact with unsuitable cleaning agents can alter or discolor the external surfaces. Only use suitable cleaning agents.

Wipe lock

- You can lock the display when cleaning the control panel and the display to prevent accidental operation during cleaning.

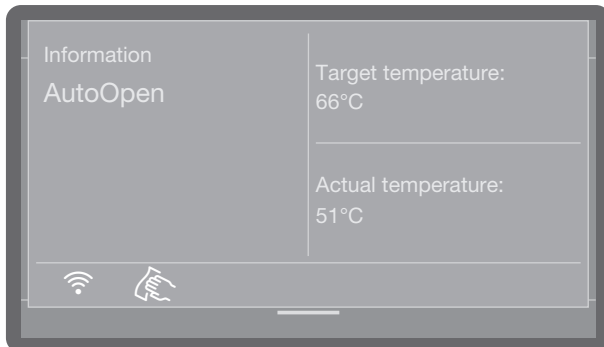

- Open the status window by tapping and dragging the orange bar at the top of the display.
- Tap the  symbol.



The display is locked to prevent operation.

- Tap and hold the  symbol for 5 seconds to end the wipe lock.

Cleaning the control panel

- Only clean the control panel with warm water and liquid dish soap, applied with a soft sponge or cloth. Then dry the control panel with a soft cloth.

 **Damage to the user interface.**
Abrasive cleaning agents can damage the user interface.
Do not use abrasive detergents!

Cleaning the machine front

- To clean the stainless steel front, use a damp cloth with a solution of liquid dish soap and hot water, or with a non-abrasive cleaning agent for use on stainless steel.

To help prevent re-soiling (fingerprints, etc.), a suitable stainless steel care product can be used after cleaning.

 **Damage to the surfaces.**
Cleaning agents containing ammonia and thinners can damage surfaces.
Avoid these products when cleaning.

 **Damage to the dishwasher caused by ingress of water.**
Do not clean the dishwasher or its immediate vicinity with a hose or a pressure washer.
Make sure that water does not enter the dishwasher when it is being cleaned.

Cleaning and care

Cleaning the wash cabinet

The wash cabinet is largely self-cleaning, provided that the correct amount of detergent is always used.

If, despite this, lime scale or grease deposits accumulate in the cabinet, these can be removed with a proprietary dishwasher cleaner (available from Miele).

Cleaning the door and the door seal

- Wipe the door seal and the area beneath the door regularly with a damp cloth to remove food deposits.
- Wipe off any food or drink residues that may have dripped onto the sides and hinges of the dishwasher door.
- With freestanding dishwashers that have a base facing, remove spillages of food and beverages from the channel that runs below the door.

⚠ Risk of cutting yourself.
There is a risk of cutting yourself. Be cautious of sharp edges when cleaning.

These surfaces are outside the wash cabinet. They are not accessed by water from the spray jets. As a result, mold fungi can develop here.

Cleaning filters in the wash cabinet

The filter combination in the base of the wash cabinet retains coarse soil from the suds solution. It prevents soiling from entering the circulation system and causing blockages in the spray arms.

When Program lock filter is activated, it is not possible to use the dishwasher without a micro-fine filter!

If the micro-fine filter is not inserted properly, it is not possible to start a program and the following fault message Program lock filter appears on the display.

Insert the micro-fine filter properly and make sure it is positioned correctly (see "Cleaning and care, Cleaning filters in the wash cabinet").

The filter combination must be checked regularly and cleaned when necessary.

⚠ Risk of injury from glass splinters. Glass splinters cannot always be detected in the filter straight away. Take extra care when cleaning the filters.

Cleaning the coarse filter

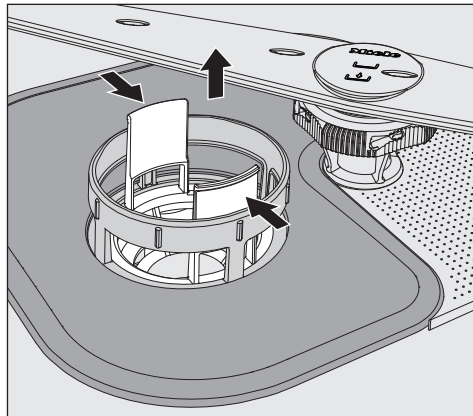

- Press the catches toward each other and remove the coarse filter.
- Rinse the filter thoroughly under running water. If necessary, use a soft cleaning brush to remove dirt.
- Replace the filter, making sure it engages correctly.

Cleaning the flat and micro-fine filters

- Remove the coarse filter as described before.

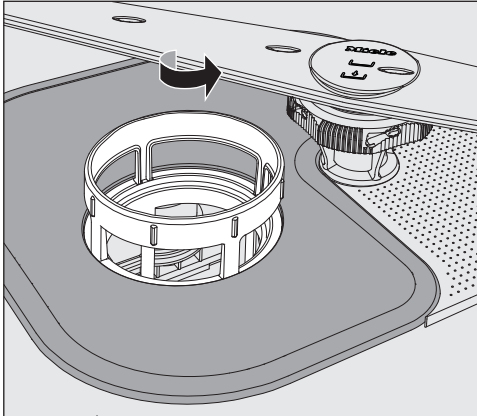

- Grasp the micro-fine filter by the upper rim and turn it in the direction of the arrow to release it. Then lift it out.

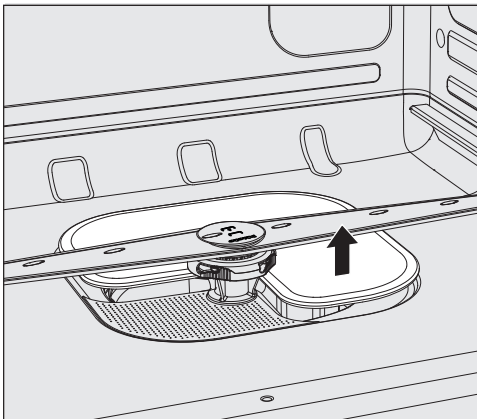

- Remove the flat filter.
- Rinse the filters under running water. If necessary, use a soft cleaning brush to remove dirt.

Replace the filter combination in the reverse order, turning the micro-fine filter to the left to re-engage it.

The flat filter must lie flat in the bottom of the wash cabinet.



The spray arms may get blocked if the filters are not replaced correctly. Ensure that the filters are positioned correctly.

Cleaning the spray arms

The dishwasher has three different spray arms.

Particles of food can get stuck in the spray arm jets and bearings. The spray arms should therefore be checked and cleaned regularly.

- Turn off the dishwasher.
- Pull the **upper spray arm** downward to remove it.

The middle and bottom spray arms are secured with a bayonet fitting. The middle spray arm is marked with the  symbol and the lower spray arm is marked with the  symbol to avoid mixing up the spray arms when they are removed.

To release the bayonet fitting proceed as follows:

- Using the knurled nut, turn the **middle spray arm** to the left as far as it will go and then pull the spray arm downward to remove it.
- Remove the lower basket.

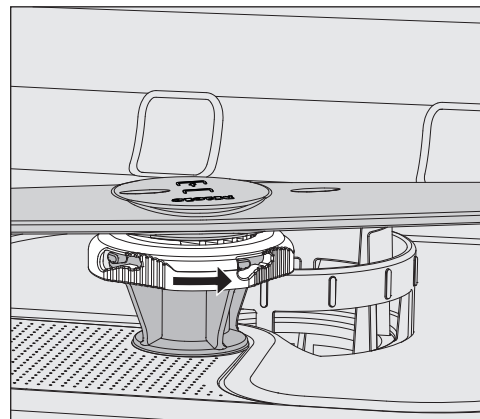

- Using the knurled nut turn the **lower spray arm** to the right as far as it will go and then pull the spray arm upward to remove it.

Cleaning and care

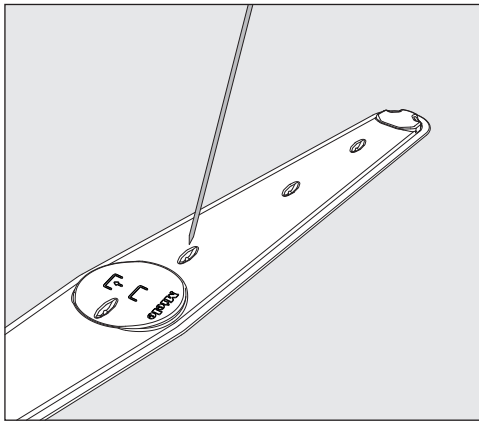

- Use a pointed object to push food particles that are stuck in the spray arm jets into the spray arm.
- Rinse the spray arms thoroughly under running water.

Reinstall the spray arms and check that they rotate freely.

Make sure that the spray arm with the yellow bayonet fitting is installed in the bottom of the wash cabinet.

Changing the air filter (depending on the model)

The air filter for Dry+ drying must be replaced at regular intervals.

A message will appear on the display when the filter needs changing.

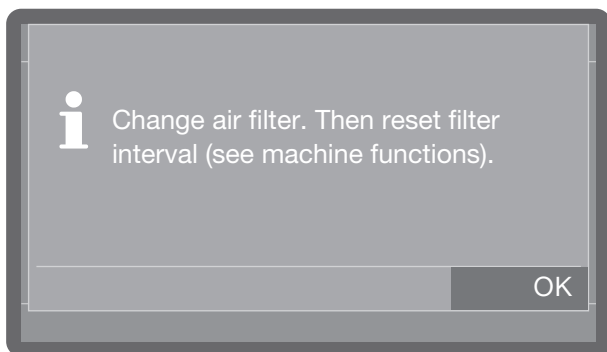

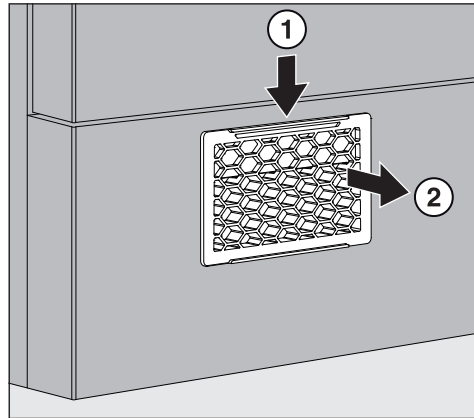

Removing the plastic support

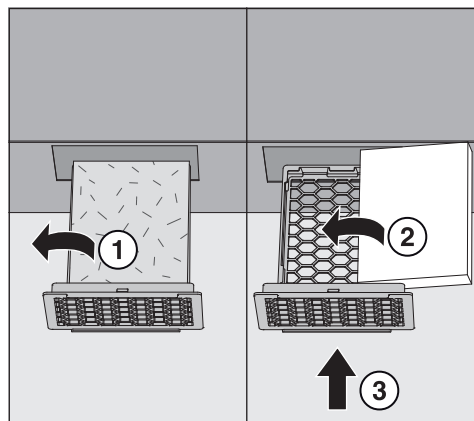

- Push the snap-fit down ① and pull the plastic support forward to remove it ②.

Replacing the filter



- Remove the used filter from the plastic support ①.
- Insert the new filter into the plastic support with the printed side facing down ② and push the plastic support into the slot in the toe-kick until it clicks into place ③.
- Reset the filter interval (see  Machine functions, Filter interval).

With the aid of the following guide, most minor problems can be corrected without contacting Miele. You can save time and money in many cases, as you do not need to contact Miele Customer Service.

The following guide should help you to find the reason for a malfunction or fault, and to correct it. However, please note:

 Danger due to incorrect repairs.

Repairs by unqualified persons can cause considerable danger to users.

Repairs should only be carried out by Miele Customer Service, an authorized Miele dealer, or a suitably qualified specialist in accordance with local and national safety regulations.

Technical faults

Problem	Possible cause and solution
The display remains dark and the Start/Stop display light is not flashing after the dishwasher has been switched on with the  button.	The electrical plug is not plugged in. ■ Insert the electrical plug.
	The circuit breaker has tripped. ■ Reset the breaker (see data plate for minimum protection rating).
The dishwasher stops during a program.	The circuit breaker has tripped. ■ Reset the breaker (see data plate for minimum protection rating). ■ If the circuit breaker trips again, contact Miele Customer Service.
Power outage during operation	If a temporary power outage occurs during a program sequence, no measures are required. The program which was running continues without interruption. If the temperature in the wash cabinet drops below the minimum value required for the program block during the power outage, the program block is repeated.

Troubleshooting



Faults with water inlet or drainage

Problem	Possible cause and solution
One of the following fault messages or notifications appears on the display:	Before remedying the fault: <ul style="list-style-type: none">■ Turn the dishwasher off with the  button.
F404 Water inlet, cold too low: check water inlet. Open water supply fully. Turn appliance off and on. If fault persists, contact service. Service phone: Serial number:	Water inlet fault. <ul style="list-style-type: none">■ Open the faucet all the way.■ Clean the water inlet filter (see “Cleaning and Care”).
F541 Water drainage: Turn appliance off and on. Start “Drain” program. Clean filter combination and non-return valve. If fault persists, contact Service. Service phone: Serial number:	Water drainage fault. There may be water in the wash cabinet. <ul style="list-style-type: none">■ Clean the filter combination (see “Cleaning and care”).■ Clean the drain pump (see “Frequently asked questions”).■ Clean the non-return valve (see “Frequently asked questions”).■ Remove any kinks or loops in the drain hose.

Cancel with fault code

If a program is canceled and a fault code appears, e.g., Fault F XXX (where XXX represents a number), there could be a serious technical fault.

In the event of a program being canceled and a fault code being shown:

- Turn the dishwasher off with the  button.
- Wait approximately 10 seconds before switching the dishwasher on again with the  button.
- Start the previously selected program again.

If the same fault message appears again:

- Make a note of the fault message.
- Turn the dishwasher off with the  button.
- Contact Miele Customer Service.





Please also read the notes regarding the following fault codes.

Problem	Possible cause and solution
Fault F 404–405	<p>If Check water intake appears on the display, the control system is checking the water intake approx. every 30 seconds. If, after three attempts, water is not getting into the dishwasher, one of these fault codes will appear on the display and the program will be canceled.</p> <ul style="list-style-type: none"> ■ Open the faucet all the way. ■ Turn the dishwasher off and back on again. ■ Select the program you want to use. ■ Press the <i>Start/Stop</i> button.
Fault F 407–408	<p>Water inlet fault.</p> <p>If the flow pressure is too low, one of these fault codes will appear on the display and the program will be canceled.</p> <ul style="list-style-type: none"> ■ The flow pressure at the water connection is too low (see “Technical data”). Contact Miele Customer Service for advice.
Fault F 413–414	<p>Water inlet fault.</p> <p>If the flow pressure is too high, one of these fault codes will appear on the display and the program will be canceled.</p> <ul style="list-style-type: none"> ■ The flow pressure at the water connection is too high (see “Technical data”). Contact Miele Customer Service for advice.
Fault F 433	<p>The door was obstructed when closing and cannot be drawn into the final closed position.</p> <ul style="list-style-type: none"> ■ Remove the obstruction from the door area.
Fault F 438	<p>Heavy objects in front of the machine can impede the automatic opening of the door via the Comfort Door Lock.</p> <ul style="list-style-type: none"> ■ Do not place (heavy) objects in front of the door of the dishwasher.

Troubleshooting



Problem	Possible cause and solution
Fault F 446	The door lock is defective. ■ Contact Miele Customer Service.
Fault F 492, 541	The program has not started properly. There may be water in the wash cabinet. ■ Clean the filter combination (see “Cleaning and care”). ■ Clean the non-return valve (see “Frequently asked questions”).
Fault F 550	The Waterproof system has reacted. ■ Close the faucet. ■ Contact Miele Customer Service.
Fault F 578	The peak-load negotiation has lasted longer than 2 hours. ■ Have your electrical system and your energy management system tested by a specialist.

Door

Problem	Possible cause and solution
The door opens again after being closed.	<p>If the door is closed with too much force, the Comfort Door Lock will open it again.</p> <ul style="list-style-type: none"> ■ Guide the door into the door lock with less force.
<p>Hot wash cabinet: Risk of injury, take care when opening the door.</p>	<p>The temperature in the wash cabinet is over 153°F (67°C) when the  button is pressed.</p> <div style="border: 1px solid black; padding: 5px; margin: 5px 0;"> <p> When the door is opened, hot steam and process chemicals can escape!</p> </div> <ul style="list-style-type: none"> ■ Open the door only when strictly necessary.
The door is open a fraction and cannot be closed using the  button.	<p>This is not a fault. The Comfort door lock has opened the door slightly at the end of the program.</p> <ul style="list-style-type: none"> ■ Open the door. The door can now be closed completely again using the  button.
<p>F433 Door blocked: Remove blockages in door area. Turn appliance off and on.</p>	<p>A protruding wash item is obstructing the door.</p> <ul style="list-style-type: none"> ■ Sort the wash items so that that they do not obstruct the door. ■ Close the door. <p>The Comfort Door Lock is blocked.</p> <ul style="list-style-type: none"> ■ Try to open the door carefully (without using force) by pulling on the door handle. <p>If the door is still blocked:</p> <ul style="list-style-type: none"> ■ Open the door using the emergency release. ■ Close the door and try to open it again using the  button. <p>If it is still blocked:</p> <ul style="list-style-type: none"> ■ Contact Miele Customer Service.
<p>Anti-trap guard: To continue, open door</p>	<p>This is not a fault. The door is locked while the door locking mechanism retracts to the lock position.</p> <ul style="list-style-type: none"> ■ Open the door and wait until the door locking mechanism reaches its final position.

Troubleshooting

General problems with the dishwasher

Problem	Possible cause and solution
The dishwasher does not respond to any button. The indicator lights and the display are dark.	The dishwasher is switched off after 10 minutes to save energy. <ul style="list-style-type: none"> ■ Press the  button to switch the dishwasher back on.
The display is dark and the Start/Stop button is flashing.	The dishwasher is switched to standby mode after 10 minutes to save energy. <ul style="list-style-type: none"> ■ Press any button to exit standby mode.
The following fault message appears on the display before the program starts: Salt container lid: check fit.	The salt container is not closed properly. <ul style="list-style-type: none"> ■ Close the container properly. <p>Salt residues are preventing it from closing.</p> <ul style="list-style-type: none"> ■ Remove the salt residues from the refilling funnel, the lid, and the seal. Do not use running water to rinse away salt residues as this can cause the container to overflow. ■ Close the container properly.
The following fault message appears on the display: F553 Salt container: Turn appliance off and on. Close flap in the door correctly. If fault persists, contact service. Service phone: Serial number:	The salt container flap has sprung open during a program. <div style="border: 1px solid black; padding: 5px; margin: 5px 0;"> <p> When the door is opened, hot steam and process chemicals can escape!</p> </div> <ul style="list-style-type: none"> ■ Open the door and close the container flap.
The following fault message appears on the display: Program lock filter	The filter combination in the base of the wash cabinet is not inserted correctly. The program does not start. <ul style="list-style-type: none"> ■ Open the door and insert the entire filter combination correctly; see “Cleaning and care, Cleaning filters in the wash cabinet”.
The dispenser cover cannot be closed.	Detergent residue is blocking the latch. <ul style="list-style-type: none"> ■ Remove the detergent residue.
The inside of the door and/or the interior walls are wet after a program has finished.	This is not a fault. It is caused by the drying system. The moisture will dissipate after a short while.

Problem	Possible cause and solution
<p>Water remains in the wash cabinet at the end of the program. (This does not apply to the Rapid program)</p>	<p>Before remedying the fault:</p> <ul style="list-style-type: none"> ■ Turn the dishwasher off with the  button.
	<p>The filter combination in the wash cabinet is clogged.</p> <ul style="list-style-type: none"> ■ Clean the filter combination (see “Cleaning and care”).
	<p>The drain pump or non-return valve is blocked.</p> <ul style="list-style-type: none"> ■ Clean the drain pump or the non-return valve (see “Frequently asked questions”).
	<p>The drain hose is kinked.</p> <ul style="list-style-type: none"> ■ Remove any kinks from the drain hose.
	<p>The on-site drain siphon is blocked.</p> <ul style="list-style-type: none"> ■ Check and clean the drain siphon.
<p>Peak-load negotiation: Heating mode temporarily disabled.</p>	<p>This is not a fault. Your energy management system has detected a peak load in the power supply. Some components in the dishwasher stop operating for the duration of the peak-load negotiation.</p>
<p>Cycles until empty</p>	<p>This is not a fault. The level of process chemicals has reached the value specified for the remaining wash cycles and this is indicated on the display.</p>
<p>Temperature compensation after door opened: Program will continue in min</p>	<p>This is not a fault. If the door is opened during a program sequence and the temperature in the wash cabinet is above 140°F (60°C), pressure equalization takes place once the door is closed.</p>

Troubleshooting

Noises

Problem	Possible cause and solution
There is a knocking noise in the wash cabinet.	A spray arm is hitting the dishware. ■ Interrupt the program, and rearrange the items which are obstructing the spray arm.
There is a rattling noise in the wash cabinet.	Dishware is moving around in the wash cabinet. ■ Interrupt the program and rearrange loose pieces.
	A foreign object (e.g. a cherry pit) has become lodged in the drain pump. ■ Remove the foreign object from the drain pump (see “Cleaning the drain pump and non-return valve”).
There is a knocking noise from the water pipe	This may be caused by the installation or the diameter of the water pipe. However, this will not affect the dishwasher function in any way. ■ If in doubt, contact a plumber.

Poor cleaning results

Problem	Possible cause and solution
The dishware is not clean.	The dishware was not loaded correctly. ■ Please observe the instructions in “Application technology, Preparing the wash items”.
	The program was not suitable for the requirements. ■ Select a more suitable program (see “Program overview”).
	Not enough cleaning agent was dispensed. ■ Use more cleaning agent.
	The cleaning agent used is not suitable for the type of soiling present. ■ Switch to another cleaning agent.
	Items are blocking the path of the spray arms. ■ Carry out a rotation check and if needed rearrange the items so that the spray arms can rotate freely.
	The filter combination in the wash cabinet is not clean or was incorrectly installed. This may have caused the spray-arm jets to become blocked. ■ Clean and/or install the filter combination correctly. ■ Clean the spray arm jets, if necessary (see “Cleaning and care”).
	The non-return valve is open and blocked. Dirty water has flowed back into the wash cabinet. ■ Clean the drain pump and the non-return valve (see “Frequently asked questions”).
	If necessary, alter the temperature and/or the holding time of the program being used. ■ Change the relevant parameters for the program. (see “Additional settings, Additional functions”)
Smearing appears on glassware and cutlery. There is a bluish sheen on the surface of glassware; film can be wiped off.	The rinse aid dosage is set too high. ■ Reduce the dosage (see “Additional settings, Additional functions, Dispensing systems”).
Dishware is not dry or cutlery and glasses are spotty.	The rinse aid dosage is set too low or the rinse aid reservoir is empty. ■ Replenish the rinse aid, increase the dosage or change the brand of rinse aid used (see “Adding rinse aid”).
The drying result is unsatisfactory for a dishwasher with Dry+.	Not a fault. The drying time was not sufficient for the dishware. ■ Extend the active drying time (see “⚙ Settings, Dry+”).

Troubleshooting

Problem	Possible cause and solution
White residue is visible on the dishware. Clouding occurs on glassware and cutlery; the deposit can be wiped off.	The rinse aid dosage is too low. ■ Increase the quantity dispensed (see “Additional settings, Additional functions, Dispensing system”).
	The salt reservoir is empty. ■ Fill the reactivation salt reservoir (see “Filling the salt reservoir”).
	The water softener is programmed to too low for the water hardness level. ■ Program the water softener assembly to the correct value (see “Additional settings, Water hardness”).
Glasses have a brownish-blue discoloration; the residue cannot be wiped off.	This may be caused by the ingredients of the cleaning agent. ■ Switch to another cleaning agent.
Glasses are dull and discolored; the deposit cannot be wiped off.	The glassware is not dishwasher-safe. The surfaces are affected. ■ Purchase glassware which is dishwasher-safe.
Tea or lipstick stains have not been completely removed.	The wash temperature of the selected program was too low. ■ Select a program with a higher wash temperature.
	The bleaching effect of the cleaning agent is too low. ■ Switch to another cleaning agent.
Plastic parts are discolored.	Natural dyes e.g. from carrots, tomatoes or ketchup may be the cause. The amount of detergent used or its bleaching effect was not sufficient to deal with natural dyes. ■ Use more detergent (see “Operation, Adding detergent”). Discolored plastic items will not regain their original color.
There are rust stains on the cutlery.	The affected items are not corrosion resistant. ■ Purchase cutlery which is dishwasher-safe.
	The “Cold” program was not run after dishwasher salt was added. Traces of salt have got into the normal wash cycle. ■ Always run the “Cold” program without any wash items after refilling the salt.
	Rust or superficial rust has built up in the wash cabinet, e.g., due to an excessively high iron content in the water or rust on other wash items. ■ Discard any rusty wash items.

Cleaning the water inlet filter

A filter is incorporated in the screw connection to protect the water intake valve. If the filter is soiled, insufficient water flows into the wash cabinet.

⚠ Risk of electric shock from voltage.
The plastic housing of the water connection contains an electrical valve.
The housing must not be dipped in water.

- Disconnect the dishwasher from the power supply.
To do this, turn off the dishwasher and disconnect the electrical plug.
- Close the faucet.
- Unscrew the water intake valve.

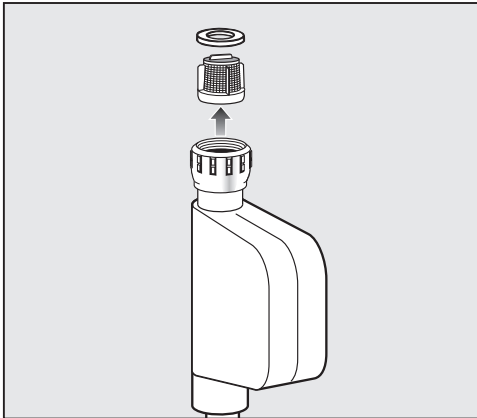

- Take the seal ring out of the screw connection.
- Using needle-nose pliers, take hold of the plastic filter bar and pull it through the filter.
- Rinse the filter under running water.
- Re-assemble in reverse order.

Screw the screw connection securely back onto the faucet. Slowly open the faucet. If water drips out, tighten the connection.

Never forget to put the filter back in place after cleaning.

Frequently asked questions

Cleaning the drain pump and non-return valve

If the water has not been pumped away at the end of a wash program (excluding the Rapid program), there may be a foreign object blocking the drain pump or the non-return valve. These are easy to remove.

- Disconnect the dishwasher from the water supply and the power supply (switch the dishwasher off, unplug the electrical plug, or disconnect or disable the breaker).
- Take the filter combination out of the wash cabinet (see “Cleaning and care”).

- Check for foreign objects blocking the drain pump before replacing the non-return valve.
- Carefully replace the non-return valve and secure it with the clamp.

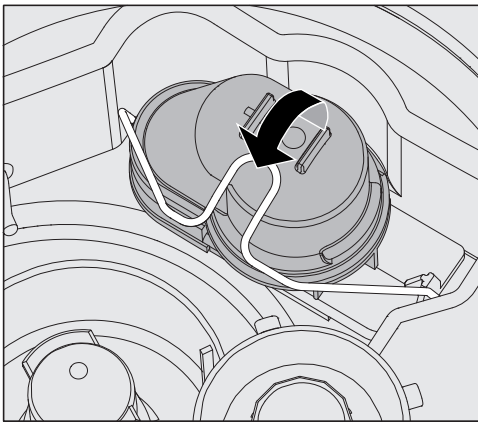





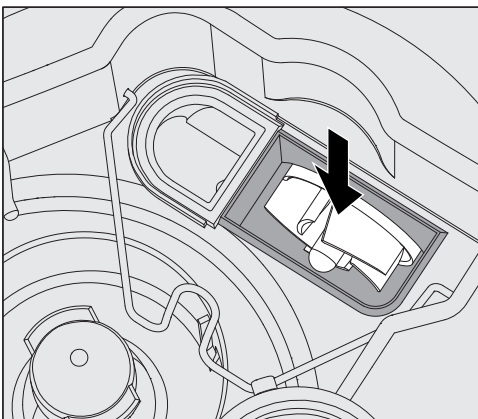









- Open the locking clamp.
- Lift out the non-return valve and rinse well under running water.
- Make sure that the vent on the outside of the non-return valve is not blocked (this vent is only visible after the non-return valve has been taken out). If it is blocked, use a pointed object to release the blockage.

The drain pump is situated under the non-return valve (arrow).



Program chart

Program	Application	Powder cleaning agent (if liquid cleaning agent is not dispensed)
		The following dosages are based on Miele cleaning products. Please follow manufacturer's instructions.
 Normal ⁽¹⁾	Program for regular use to completely wash a full load of normally soiled dishes	20–25 g or 1 detergent tab
 Normal plus	For more soiled wash items.	20–25 g or 1 detergent tab
 Intensive	For heavily soiled wash items.	20–25 g or 1 detergent tab
 Rapid	“Quick program” for lightly soiled wash items that are in continual use and that have fresh, easily removed food residues.	20–25 g placed on the inside of the door
 SaniWash	For wash items that must be hygienically reprocessed.	20–25 g or 1 detergent tab
 Sanitize plus (depending on model)	For wash items that must be hygienically reprocessed.	20–25 g or 1 detergent tab
 China & Crystal	Special glasses program.	20–25 g or 1 detergent tab
 Glasses (depending on model)	Special program for beer glasses. The glasses do not dry through their own heat after the program has ended and may have to be dried by hand.	20–25 g or 1 detergent tab
 Utensils	Special program for cutlery.	20–25 g or 1 detergent tab
 Plastics	Special program for plastic items and other lightweight wash items.	20–25 g or 1 detergent tab
 Economy	Energy-saving program offering the most efficient combined energy and water consumption for normally soiled dishware.	20–25 g or 1 detergent tab
 Reactivation	Manual reactivation. This can be run to avoid being forced to run a reactivation program during busy periods.	
 Cold	Use for rinsing heavily soiled wash items and to prevent soiling from drying on. Also used for flushing salt residues out after refilling the salt container.	
 Drain	For pumping away the water when, for example, the water for the Rapid program needs to be renewed or a program has been canceled.	

(1) This program is used for energy labeling purposes.

Program parameters

Program	Model (see data plate)	Program sequence								
		1. Pre-wash 1	2. Pre-wash 2	3. Main wash 1 <small>(1), (2)</small>	4. Interim rinse 1	5. Interim rinse 2	6. Final rinse 1 <small>(1), (2)</small>	7. Dry+ <small>55+</small>	8. AutoOpen	
Normal	PFD 401	X		X 131°F (55°C) 1 min			(X)	X 140°F (60°C) 1 min	-	-
	PFD 404	X		X 131°F (55°C) 1 min			(X)	X 140°F (60°C) 1 min	-	-
	PFD 401	X		X 131°F (55°C) 2 min	X		(X)	X 140°F (60°C) 1 min	-	-
	PFD 404	X		X 150°F (66°C) 1 min	X		(X)	X 185°F (85°C) 1 min	-	-
Normal plus	PFD 401	X	X	X 150°F (66°C) 3 min	X		(X)	X 140°F (60°C) 1 min	-	-
	PFD 404	X	X	X 150°F (66°C) 3 min	X		(X)	X 185°F (85°C) 1 min	-	-
Rapid *)	PFD 401			X 131°F (55°C) 30 s			(X)	X 131°F (55°C) 30 s	-	-
	PFD 404			X 131°F (55°C) 30 s			(X)	X 131°F (55°C) 30 s	-	-
SaniWash	PFD 401	X		X 160°F (70°C) 10 min	X		(X)	X 140°F (60°C) 1 min	-	-
	PFD 404	X		X 140°F (60°C) 3 min	X		(X)	X 185°F (85°C) 4 min	-	-
Sanitize plus	PFD 401									
	PFD 404	X		X 160°F (70°C) 10 min	X		(X)	X 185°F (85°C) 4 min	-	-

Program	Model (see data plate)	Program sequence							
		1. Pre-wash 1	2. Pre-wash 2	3. Main wash 1 (1), (2)	4. Interim rinse 1	5. Interim rinse 2	6. Final rinse 1 (1), (2)	7. Dry+ (1), (2)	8. AutoOpen
☐ China & Crystal	PFD 401			X 120°F (50°C) 1 min	X	(X)	X 120°F (50°C) 1 min	-	-
	PFD 404			X 120°F (50°C) 1 min	X	(X)	X 120°F (50°C) 1 min	-	-
☐ Glasses	PFD 401			X 120°F (50°C) 1 min	X	(X)	X (3) 1 min	-	-
	PFD 404			X 120°F (50°C) 1 min	X	(X)	X (3) 1 min	-	-
☐ Utensils	PFD 401		X	X 140°F (60°C) 2 min	X	(X)	X 131°F (55°C) 1 min	-	-
	PFD 404		X	X 140°F (60°C) 2 min	X	(X)	X 131°F (55°C) 1 min	-	-

X Scheduled program block

(X) Additional program block; deactivated ex-works (activated by Customer)

① Temperature adjustable from 85-185°F (30-85°C)

Except:

- Rapid program adjustable to max. 160°F (70°C)

② Holding time adjustable from 0-10 minutes

Except:

- Rapid program adjustable from 0-255 seconds

③ Cold water without rinsing agent

***1) Important note for the Rapid program**

With the Rapid program, water from the final rinse is not pumped away at the end of the program. It will be used as the cleaning water in the next Rapid program. If the water temperature drops below 105°F (40°C) or if another program is started, this water will be automatically pumped away when the program starts.

- Program block not available for this program or program not available for this model

Program parameters

Program	Model (see data plate)	Program sequence							
		1. Pre-wash 1	2. Pre-wash 2	3. Main wash 1 <small>①, ②</small>	4. Interim rinse 1	5. Interim rinse 2	6. Final rinse 1 <small>①, ②</small>	7. Dry+ <small>③</small>	8. AutoOpen
Plastics	PFD 401	X		X 120°F (50°C) 5 min	X	(X)	X 140°F (60°C) 1 min	-	-
	PFD 404	X		X 120°F (50°C) 5 min	X	(X)	X 140°F (60°C) 1 min	-	-
Economy	PFD 401			X 115°F (46°C) 15 min	X	(X)	X 120°F (50°C) 2 min	-	-
	PFD 404			X 115°F (46°C) 15 min	X	(X)	X 120°F (50°C) 2 min	-	-
Reactivation	All	Reactivation sequence							
Cold	All		X						

- X Scheduled program block
- (X) Additional program block; deactivated ex-works (activated by Customer)
- ① Temperature adjustable from 85-185°F (30-85°C)
Except:
- Rapid program adjustable to max. 160°F (70°C)
- ② Holding time adjustable from 0-10 minutes
Except:
- Rapid program adjustable from 0-255 seconds
- ③ Cold water without rinsing agent
- Program block not available for this program or program not available for this model

Customer Service

If, despite following the notes in these operating instructions, you are unable to rectify a problem, please contact one of the following, quoting the fault code shown on the display:

- your Miele dealer, or
- Miele Customer Service

Contact details for Miele Customer Service can be found at the back of these operating instructions.

■ When contacting Miele Customer Service, you will need the model number and 8-digit machine number of the dishwasher.

Both are shown on the data plate, located at the top of the door.

INSTALLATION INSTRUCTIONS

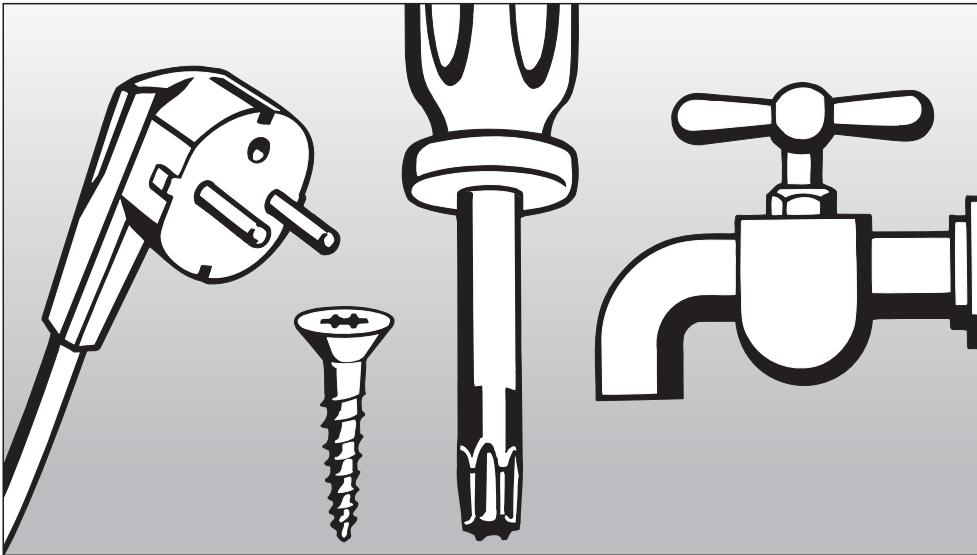

Please refer to the Installation Diagram supplied with these instructions.
To comply with IEC sound testing protocols, please contact Miele for additional instructions.

Information is subject to change. Please refer to our website to obtain the most current product specification, technical & warranty information.

Installation

⚠ Damage caused by condensation. In order to reduce the risk of damage from condensation, the cabinetry in the area around the dishwasher should be designed for commercial use. Only use cabinetry that is designed for commercial use.

The dishwasher must be stable and horizontal. Any unevenness in the floor level and height of the machine can be compensated for by adjusting the four feet.

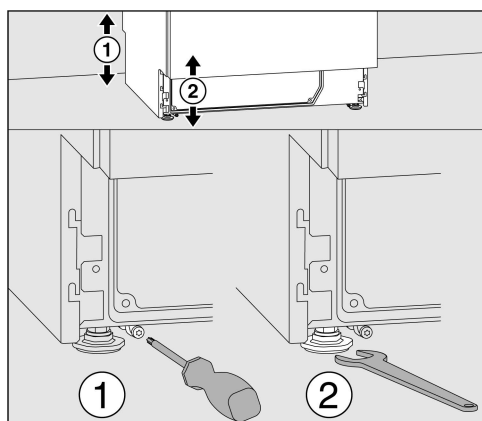

The machine height can be adjusted from 32 5/16" -34 5/8" (820–880 mm) using the machine feet. Dishwashers with lids have an additional 9/16" (15 mm) in height. The front machine feet can be adjusted with a wrench (wrench size 13); the rear ones can be adjusted with a T20 Torx screw. If the runners of the rear machine feet are not installed, the machine feet can also be adjusted with the wrench. They are adjusted upward when turned clockwise and downward when turned counterclockwise.

If the dishwasher is to be installed next to other machines and cabinetry or in a recess, an installation space measuring at least 23 5/8" (600 mm) in width and 23 5/8" (600 mm) in depth is required.

Dishwashers with active drying require a space measuring 22 3/4" (580 mm) in depth.

Undercounter installation

⚠ Risk of the machine tipping. To ensure stability, an undercounter dishwasher must only be installed beneath a continuous countertop that is bolted to the adjacent cabinetry. Install the dishwasher underneath a bolted continuous countertop.

If the dishwasher is to be installed beneath a continuous countertop, an installation space measuring at least 23 5/8" (600 mm) wide, 23 5/8" (600 mm) deep, and 32 5/16" (820 mm) high is required. Dishwashers with active drying require an installation space measuring 22 3/4" (580 mm) in depth.

Dishwashers with a plinth return are supplied with a toe-kick filler panel. This can be installed instead of a toe-kick board.

When adjusting the dishwasher height, the feet must not be unscrewed by more than 2 3/8" (60 mm).

Hose holder

The supplied hose holders can be used to lay the power cord and the hoses for supply and waste water in a way that saves space. The hose holder prevents hoses from kinking or crushing when installing the machine in tight recesses.

The power cord and hoses can be laid either on the left or the right, depending on the connection situation.

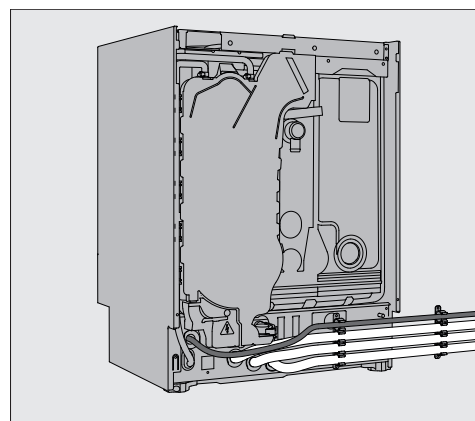

Installation

Adjustable toe-kick panel (depending on the model)

Dishwashers with internal dispensing or active drying have an adjustable toe-kick panel.

- Level the dishwasher.
- Open the dishwasher door halfway and loosen the two screws now visible at the top of the toe-kick panel.
- Pull the toe-kick panel upward first and then forward.
- Loosen the two screws on the right and left of the toe-kick behind the panel.
- Pull the inside of the toe-kick down to the floor.
- Tighten the two screws again.
- Reassemble the toe-kick panel by following the instructions above, but in reverse order.

Removing the machine lid

If the dishwasher is installed with a lid, it can be removed as follows:

- Remove both securing screws on the back of the dishwasher with a screwdriver.
- Open the door.

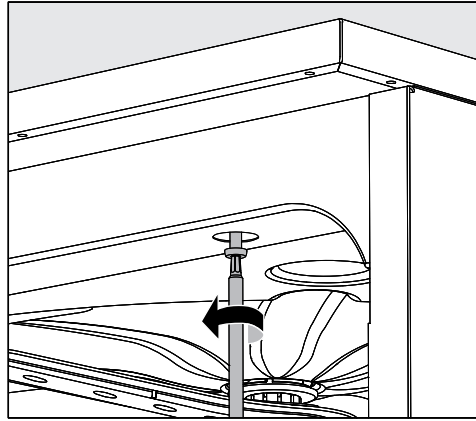

- Unscrew the left and right fastening screws with a screwdriver.
- Lift the machine lid upward to remove.

Leveling and securing the dishwasher

To guarantee stability, the dishwasher must be secured to the countertop after leveling.

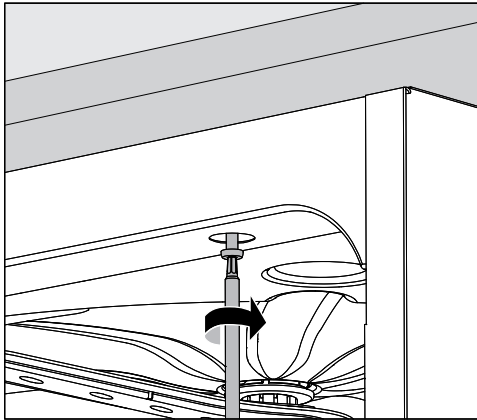

- After leveling, secure the dishwasher to the continuous countertop. With the door open, screw into the countertop through the holes in the front trim on the left- and right-hand sides of the dishwasher.

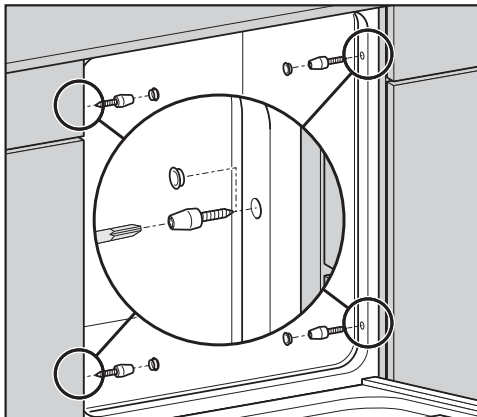

With stainless steel or stone countertops, the dishwasher must be secured at the sides to the left and right adjacent cabinetry with two screws on each side.

Special screws (4 x 27/Torx T20) are supplied in the accessories companion pack. Holes must be drilled in the side wall in front of the door seal for these.

In the case of undercounter dishwashers, the holes are already provided in the side walls.

The gaps between undercounter dishwashers and adjacent cabinets or machines must not be filled with silicone sealant as this could compromise the ventilation of the circulation pump.

Depending on the undercounter situation, the stainless steel cover plate supplied can be attached to the lower edge of the countertop. The stainless steel cover plate protects the lower edge of the countertop against steam damage.

Installation

Leveling and securing the dishwasher

To guarantee stability, the dishwasher must be secured to the countertop after leveling.

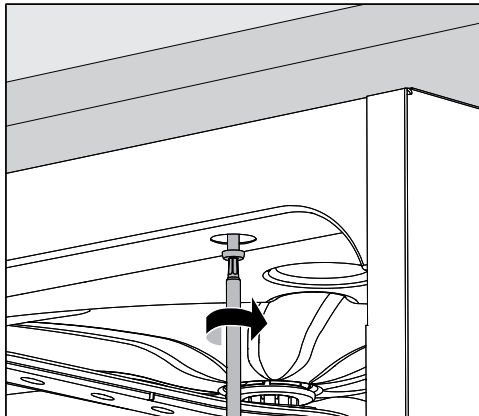

- After leveling, secure the dishwasher to the continuous countertop. With the door open, screw into the countertop through the holes in the front trim on the left- and right-hand sides of the dishwasher.

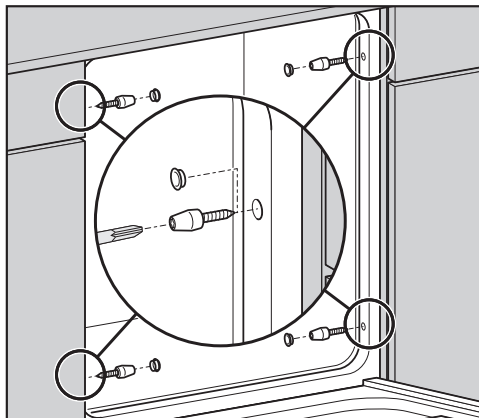

With stainless steel or stone countertops, the dishwasher must be secured at the sides to the left and right adjacent cabinetry with two screws on each side.

Special screws (4 x 27/Torx T20) are supplied in the accessories companion pack. Holes must be drilled in the side wall in front of the door seal for these.

In the case of undercounter dishwashers, the holes are already provided in the side walls.

The gaps between undercounter dishwashers and adjacent cabinets or machines must not be filled with silicone sealant as this could compromise the ventilation of the circulation pump.

Depending on the undercounter situation, the stainless steel cover plate supplied can be attached to the lower edge of the countertop. The stainless steel cover plate protects the lower edge of the countertop against steam damage.

Moving the dishwasher's installation site

Before moving the dishwasher, screw in the adjustable feet fully so that they do not get damaged.

⚠ Component damage caused by carrying.

Do not lift the dishwasher by any protruding components, e.g., the control panel. These parts could break off.

Do not hold onto protruding components when moving the dishwasher.

⚠ Damage caused by transportation using a hand truck.

Using a hand truck to subsequently move the dishwasher may cause damage to the machine.

Only transport the dishwasher on a hand truck in its original packaging. For subsequent moves, the dishwasher must be placed on a continuous base to avoid damage.

Electrical connection

 Danger caused by improper electrical connection

All electrical connection work must be carried out by a qualified electrician in accordance with local and national safety regulations.

Ask a qualified specialist to complete the electrical connection work.

- The electrical installation must be in compliance with current local and national safety regulations!
- The connection to the power supply must comply with national regulations (plug and socket must be accessible after the machine has been installed). An electrical safety test can be carried out after any service or maintenance work.
- If the dishwasher is hard-wired to the power supply, a circuit breaker capable of disconnecting the dishwasher at all poles must be installed in accordance with local codes.
- If necessary, equipotential bonding must be carried out.
- The power cord should only be replaced with an original Miele spare part.
- For technical data, see the data plate or the attached wiring diagram.

The machine must only be operated with the voltage, frequency, and fuse rating shown on the **data plate**.

This machine **can be converted to a different type of power supply** in accordance with the conversion diagram and wiring diagram supplied.

The **conversion diagram** and the **data plate** are on the dishwasher or supplied with it.

WARNING

THIS APPLIANCE MUST BE GROUNDED

GROUNDING INSTRUCTIONS

For a grounded, cord-connected appliance:

This appliance must be grounded. In the event of a malfunction or breakdown, grounding will reduce the risk of electric shock by providing a path of least resistance for electric current. This appliance is equipped with a cord having an equipment-grounding conductor and a grounding plug. The plug must be plugged into an appropriate outlet that is installed and grounded in accordance with all local codes and ordinances.

For a permanently connected appliance:

This appliance must be connected to a grounded metal, permanent wiring system, or an equipment-grounding conductor must be run with the circuit conductors and connected to the equipment-grounding terminal or lead on the appliance.

Electrical connection

Peak-load negotiation

The dishwasher is suitable for use in an energy management system. For this purpose, the dishwasher must be technically adapted and the controls reset by Miele Customer Service.

Please contact Miele Customer Service for additional information.

Load management

In the event of a peak-load negotiation, some dishwasher components, such as the heater elements, will be switched off for a while. The dishwasher will remain on during this period and the current program will not be interrupted. If one of the components that is switched off is needed during the current program stage, the program cycle time will simply increase for the duration of the load negotiation.

Load negotiation is indicated by the following message, e.g.:

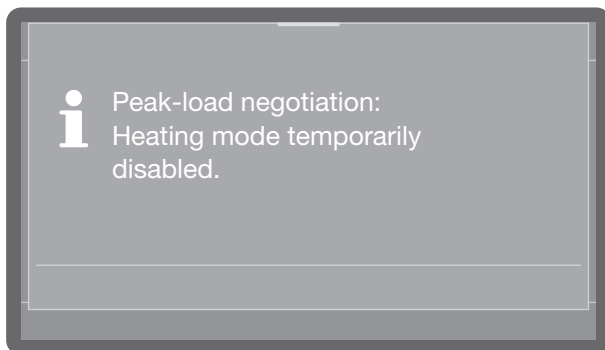

Connecting the water inlet

⚠ Health risk posed by process chemicals

Water in the dishwasher must not be used as drinking water.

Do not drink water from the dishwasher.

Do not re-use removable sets of hoses. Do not re-use removable hose attachments. Use the sets of hoses supplied with the dishwasher.

- The dishwasher must be connected to the water supply in strict accordance with current local and national water authority regulations.
- The water used must at least comply with national codes for drinking water quality. If the water supply has a high iron content, there is a risk of corrosion occurring on wash items in the dishwasher, as well as the dishwasher itself. If the chloride content of the water exceeds 100 mg/l, the risk of corrosion to wash items being cleaned in the dishwasher will be further increased.
- In certain regions (e.g., mountainous regions), the water composition may cause precipitates to form, requiring the use of softened water for the dishwasher.
- The water pressure (flow pressure) must amount to at least 29 psi (200 kPa) overpressure (100 kPa = 1 bar = 14.5 psi). At a water pressure (flow pressure) below 29 psi (200 kPa), the water inlet time extends automatically. The maximum permissible static pressure amounts to 145 psi (1,000 kPa) (overpressure). If the water pressure does not lie in the 29-145 psi (200–1,000 kPa) range, contact Miele Customer Service for advice.
- The dishwasher is supplied as standard for connection to cold water (blue coded hose) **and** hot water up to max. 150°F (65°C) (red coded hose). Connect the water inlet hoses to the supply valves for cold and hot water.
- If no hot water supply is available, the inlet hose with the **red** marking must also be connected to the cold water supply.
- A faucet with a 3/4 inch male thread must be provided on site. This should be easily accessible, since the water inlet should be shut off whenever the machine is not in use.
- The DN 10 water inlet hose is approx. 67" (1.7 m) long, terminating in a 3/4 inch female thread. A 59" (1.5 m) long flexible metal extension hose (tested to 140 bar) is available as an optional accessory if required. On no account may the inlet filter in the female thread be removed.

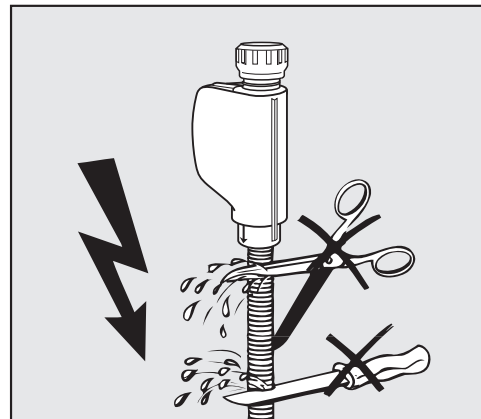

⚠ Damage caused by shortening the hose.

Do **not** shorten or otherwise damage the water inlet hoses supplied with the machine.

Do not shorten the water inlet hoses.

Please also refer to the installation plan provided.

Plumbing

Connecting the water drainage system

- The dishwasher drainage system has a non-return valve, which prevents dirty water from flowing back into the dishwasher via the drain hose.
- The dishwasher drainage hose should be connected to a **separate** on-site drainage system for the dishwasher only. If no separate drain is available, we recommend connecting it to a dual-chamber siphon. The on-site connection must be between 12" (0.3 m) and 39" (1 m) in height, measured from the lower edge of the machine. If the connection is lower than 12" (0.3 m), the drain hose must be placed in an arc at least 12" (0.3 m) high.
- The dishwasher is supplied with an approx. 59" (1.5 m) flexible drain hose with an internal diameter of 7/8" (22 mm). Hose clips are supplied with the dishwasher.
- The drain hose must not be shortened. The hose can be extended using a connection piece to attach a further length of hose. The drainage length must not be longer than 13 ft (4 m).
- The drainage system must be able to handle a discharge rate of at least 4.2 gpm (16 l/min).

⚠ Damage caused by incorrect routing. Make sure that there are no kinks in the drain hose, and that it is not crushed or stretched.
Make sure that there are no kinks in the drain hose and that it is not crushed or stretched.

Please refer to the installation plan provided.

Technical details

	Imperial	Metric
Height with machine lid Height without machine lid	32 7/8" adjustable + 2 1/4" 32 5/16" adjustable + 2 1/4"	835 mm adjustable + 60 mm 820 mm adjustable + 60 mm
Width	23 1/2"	598 mm
Depth Depth with door open	23 1/2" 47 1/4"	580 mm 1,180 mm
Weight (net)	Approx. 154 lbs	Approx. 70 kg
Voltage, rated load, fuse rating	See data plate	See data plate
Power supply cord	Approx. 5' 6"	Approx. 1.7 m
Water connection water temperature: Cold water/steam condenser (optional) Hot water	Max. 68°F Max. 149°F	Max. 20°C Max. 65°C
Static water pressure	Max. 145 psi	1.000 kPa overpressure
Minimum water connection flow pressure: Cold water/steam condenser (optional) Hot water	14.5 psi 5.8 psi	100 kPa overpressure 40 kPa overpressure
Recommended water connection flow pressure: Cold water/hot water Steam condenser (optional – connection via cold water)	29 psi 14.5 psi	≥ 200 kPa overpressure ≥ 200 kPa overpressure
Water inlet hose	Approx. 5' 7"	Approx. 1.7 m
Drain hose	Approx. 4' 9"	Approx. 1.5 m
Delivery head	Min. 1', max. 3' 3"	Min. 0.3 m max. 1.0 m
Drainage length	Max. 13' 1"	Max. 4.0 m
Operating conditions: Ambient temperature Maximum relative humidity Linear decrease to Minimum relative humidity	40 - 104°F 80 % for temperatures up to 88°F 50% for temperatures up to 104°F 10%	5°C to 40°C 80% for temperatures up to 31°C 50% for temperatures up to 40°C 10%
Storage and transportation conditions: Ambient temperature Relative humidity Air pressure	-4°F to 140°F 10% to 85% 7.25 psi to 15.37 psi	-20°C to 60°C 10% to 85% 500 hPa to 1060 hPa
Altitude above sea level (according to IEC/EN 60335)	Up to 6,561 ft*	Up to 2,000 (m)*
Protection category (according to IEC 60529)	IP21	IP21
Noise emission values Sound power in LwA Sound pressure in LpA	Undercounter installation with wooden trim in front of toe-kick, Short program 59 dB (A) 47 dB (A)	Undercounter installation with wooden trim in front of toe-kick, Short program 57 dB (A) 45 dB (A)
WiFi standard	802.11 b/g/n	
WiFi frequency band	2,400-2,483.5 MHz	
Maximum WiFi transmission power	< 100 mW	
Certification marks	Intertek approval	
Manufacturer's address	Miele & Cie. KG, Carl-Miele-Strasse 29, 33332 Gütersloh, Germany	

* If installation site is above 2,000 m, the boiling point of the wash water will be lower. For this reason, the program parameters may have to be adjusted.

**Please have the model and serial number
of your machine available when
contacting Technical Service.**

U.S.A.

Miele, Inc.

National Headquarters

9 Independence Way
Princeton, NJ 08540
Phone: 800-991-9380
www.mieleusa.com/professional
prosales@mieleusa.com

Technical Service & Support

Phone: 800-991-9380
proservice@mieleusa.com

Canada

**Importer
Miele Limited**

Professional Division

161 Four Valley Drive
Vaughan, ON L4K 4V8
Phone: 1-888-325-3957
www.mieleprofessional.ca
professional@miele.ca

Miele Professional Technical Service

Phone: 1-888-325-3957
serviceprofessional@miele.ca



Manufacturer: Miele & Cie. KG
Carl-Miele-Straße 29, 33332 Gütersloh, Germany