



AGArangeusa.com

THE AGA MARQUEE HOOD



SPECIFICATIONS

Hood Style

Arched Front

Product Dimensions:

Hood Width x Depth x Height

36"W x 24"D x 30"H (600 cfm/8" collar)

48"W x 24"D x 30"H (1200 cfm/10" collar)

Duct Cover Options

12", 24" and 48" Tall

Custom Duct Cover heights are available

Product Weight:

36"(30"H) : 101 lbs

48"(30"H) : 126 lbs

MODELS:

36" : **AH3630MRQ**

48" : **AH4830MRQ**

Hood Sone Level:

Ranges from 5-7

Electrical Requirements:

600 CFM models draw approx. 2.7 Amps

1200 CFM models draw approx. 5.4 Amps

COLOR FINISH OPTIONS

CLASSIC COLOR COLLECTION



Stainless Steel (SS)



Matte Black (MBL)



White (WHT)



Gloss Black (BLK)



Indigo (IND)



Cornwall Green (CWG)

SOHO COLOR COLLECTION



Slate (SLT)



Stone Blue (STB)



Mineral Green (MG)



Carnaby Blue (CBB)



Fawn (FWN)



Piccadilly Red (PCR)



Salcombe Blue (SAL)



Cranberry (CNB)

TRIM FINISH OPTIONS



Brushed Nickel (BN)



Polished Chrome (PC)

NOTE: Due to global sourcing, paint and / or trim may have minor variations



Brushed Brass (BB)



Polished Brass (PB)

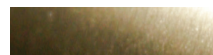

Antique Brass (AB)

DIMENSIONAL DRAWINGS

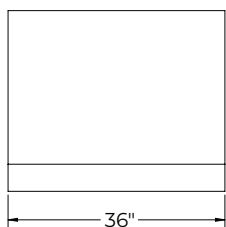

36" FRONT VIEW

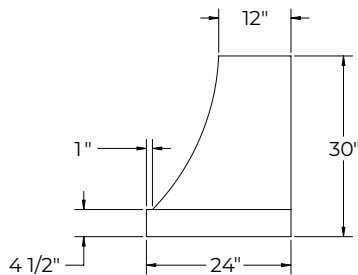

36" SIDE VIEW

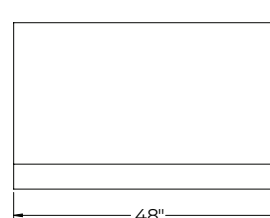

48" FRONT VIEW

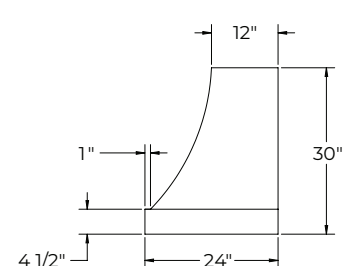

48" SIDE VIEW



THE AGA MARQUEE HOOD

PRODUCT FEATURES

Quiet Operation

Large 3 speed blower operates at lower RPM reducing the sound level.

Lighting

Bright LED lighting offers natural looking, 3000K color spectrum. The 36" hood features 2 lights, the 48" hood features 3 lights.

Ease of Operation

Electronic touch controls for 3 speed blower and LED lights.

Easy Cleaning

Dishwasher safe, commercial style baffle filters for effectively removing airborne contaminants.

Detergent inlet holes and grease exit holes in baffle filters for superior dishwasher cleaning.

Flexible Installation

Mounting bars at top and bottom allow for attaching to stud supports. Open top and back design for centered duct location or offset top duct and/or rear offset discharge.

Energy Efficient Operation

LED light bulbs draw only 6 watts each and energy efficient motors draw only 2.5 amps.

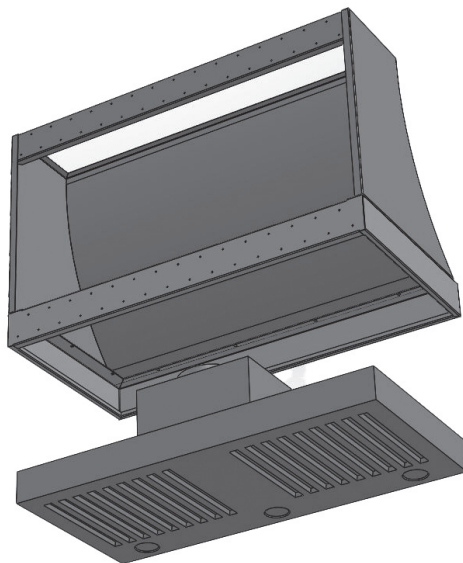

Rear view showing liner is easily removed and reinstalled for simply mounting of hood shell to the wall

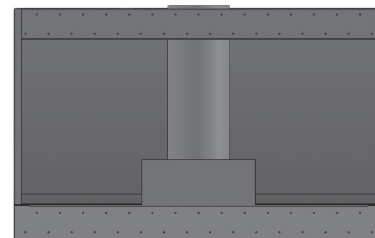

Rear view of standard, centered top venting. Open top design allowing simple R/L offset top ducting

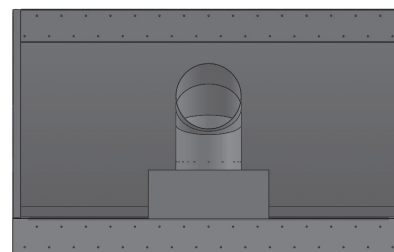

Rear view of standard, centered rear venting. Open back design allowing simple R/L offset rear ducting