



AGArangeusa.com

# THE AGA LOGE HOOD



## SPECIFICATIONS

**Hood Style**  
Box

## MODELS:

36" : **AH3630LGE**  
48" : **AH4830LGE**

## Product Dimensions:

*Hood Width x Depth x Height*

36"W x 24"D x 30"H, 42"H or 54"H (600 cfm/8" collar)  
48"W x 24"D x 30"H, 42"H or 54"H (1200 cfm/10" collar)

## Product Weight:

36"(30"H) : 104 lbs / 36"(42"H) : 122 lbs / 36"(54"H) : 141 lbs  
48"(30"H) : 130 lbs / 48"(42"H) : 151 lbs / 48"(54"H) : 172 lbs

## Electrical Requirements:

600 CFM models draw approx. 2.7 Amps  
1200 CFM models draw approx. 5.4 Amps

## Hood Sone Level:

Ranges from 5-7

## COLOR FINISH OPTIONS

### CLASSIC COLOR COLLECTION

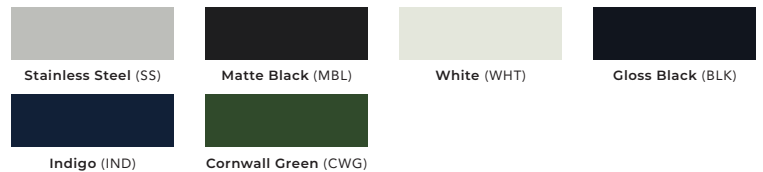

### SOHO COLOR COLLECTION

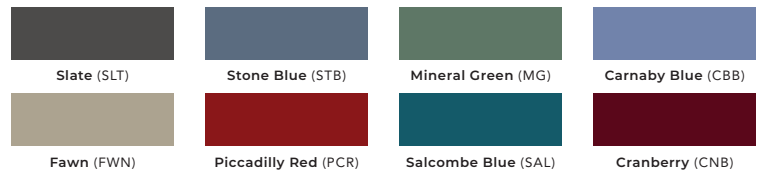

## TRIM FINISH OPTIONS

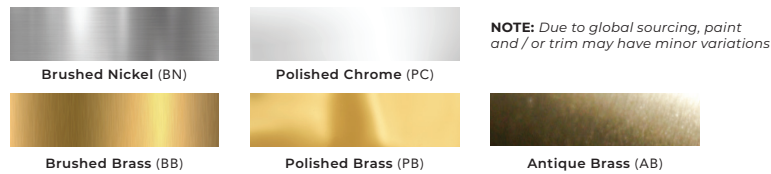

## DIMENSIONAL DRAWINGS



**36" FRONT VIEW**  
(37" WIDTH WITH 1/2" BANDS)

**36" SIDE VIEW**

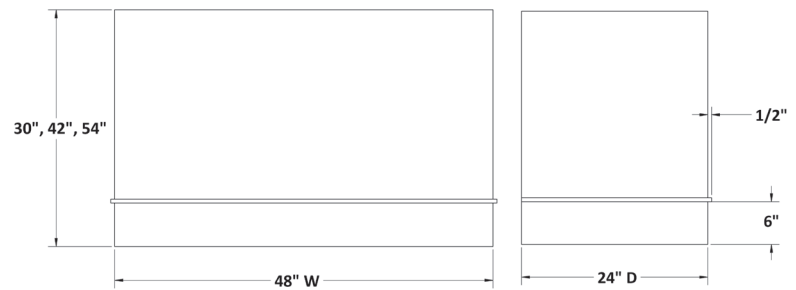

**48" FRONT VIEW**  
(49" WIDTH WITH 1/2" BANDS)

**48" SIDE VIEW**



# THE AGA LOGE HOOD

## PRODUCT FEATURES

### Quiet Operation

Large 3 speed blower operates at lower RPM reducing the sound level.

### Lighting

Bright LED lighting offers natural looking, 3000K color spectrum. The 36" hood features 2 lights, the 48" hood features 3 lights.

### Ease of Operation

Electronic touch controls for 3 speed blower and LED lights.

### Easy Cleaning

Dishwasher safe, commercial style baffle filters for effectively removing airborne contaminants.

Detergent inlet holes and grease exit holes in baffle filters for superior dishwasher cleaning.

### Flexible Installation

Mounting bars at top and bottom allow for attaching to stud supports. Open top and back design for centered duct location or offset top duct and/or rear offset discharge.

### Energy Efficient Operation

LED light bulbs draw only 6 watts each and energy efficient motors draw only 2.5 amps.

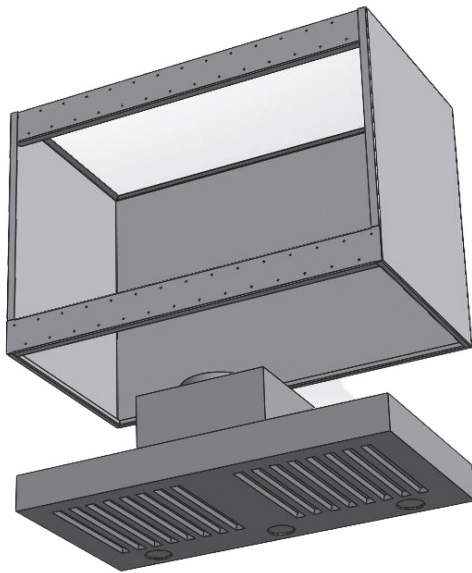

Rear view showing liner is easily removed and reinstalled for simply mounting of hood shell to the wall

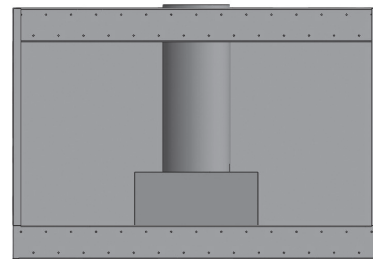

Rear view of standard, centered top venting. Open top design allowing simple R/L offset top ducting

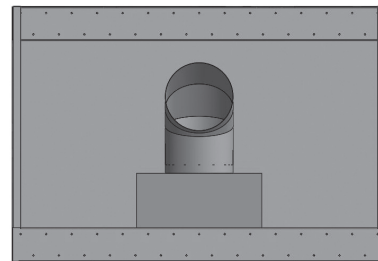

Rear view of standard, centered rear venting. Open back design allowing simple R/L offset rear ducting