

Dear Customer,

Thank you for choosing this quality product from ASKO.

We hope it will meet your expectations and fulfil your needs for many years to come. Scandinavian design combines clean lines, everyday functionality and high quality. These are key characteristics of all our products and the reason they are greatly appreciated throughout the world.

To get the most out of your new machine, we recommend that you read the operating instructions before using the machine. The operating instructions also include information on how you can help protect the environment.



Operating Instructions

Washing Machine
ASKO W6424W

Contents

Before using your machine for the first time	5	Dyeing fabrics	13
Transport protection	5	Liquid detergents	14
Packing material	5	Detergents	14
Washer door	5	Recommended powder detergents	14
Checking water hardness	5	Detergent Amounts Based on Water Hardness	14
Important safety instructions	6	Amount of detergent to use	14
Grounding instructions	7	Operating instructions	16
Installation	7	Sort your laundry.	16
Overflow guard function	7	Turn on the main power switch	16
Transport/Winter storage	7	Open the washer door and load the laundry	16
Disposal	7	Add detergent and fabric softener, as required	17
Child safety	8	Select the program	18
Keep an eye on children!	8	Select options	21
Parts of the washing machine	9	Close the washer door and press the Start/Stop button	22
Dispenser	10	Once the program has finished	23
Advice and tips before washing	11	Settings	24
Sorting your laundry	11	You can change the following settings:	24
Clothing	11	Door opening	24
Laundry labels	11	Extra rinses	24
Laundry label symbols	11	Care and maintenance instructions	25
Advice and tips before washing	12	Cleaning the trap and the drain pump	25
Coloured cotton	13	Cleaning the detergent compartment	25
Unbleached linen	13	Cleaning the outside of the machine	25
Wool	13	Cleaning the inside of the machine to avoid unpleasant smells	26
Rayon fibers and synthetic fibers	13	Rinse holes under the paddle	26
Reducing allergic reactions	13	If you have hard water	26
Save time and energy	13		
Economy and efficiency	13		
Detergents	13		

Original instruction

Contents

Troubleshooting	27
The washer door will not open	27
The machine will not start	27
After power failure	27
Wet laundry still in the machine	27
Error messages	28
Technical information	29
Technical data	29
Transport protection	30
Installation	31
Water supply connection	31
Service	34
Limited Warranty – Residential Appliances	34
Quick guide	40

Before using your machine for the first time

Do you need this Use&Care Guide in Spanish? Log on to www.askona.com/customer-care to download.

¿Necesita esta Instrucciones de uso y cuidado en español? Entre en www.askona.com/customer-care y descárguela.

Before using your machine for the first time

Transport protection

Remove any transport protection devices before installing the machine. See the "Transport protection" chapter.

Packing material

Please sort waste materials in accordance with local guidelines.

Washer door

- The washer door cannot be opened until the machine is connected to the electricity supply.
- To open the door manually, see "The washer door will not open" in the "Troubleshooting" chapter.
- The machine cannot be started when the door is open.
- To open the washer door while a program is running, see "Close the door and press the Start/Stop button" in the "Operating instructions" chapter.

Checking water hardness

The quantity of detergent needed depends, among other things, on water hardness. See the detergent pack for details. Phone your local water company to check the water hardness in your area.

NOTE!

Each machine is tested before leaving the factory.

A small amount of water may remain in the drain pump, though this does not affect quality or damage the machine.

See Quick guide on the last page

Important safety instructions



SAVE THESE INSTRUCTIONS FOR FUTURE REFERENCE

WARNING!



To reduce the risk of fire, electric shock, or injury to persons when using your appliance, follow basic precautions, including the following:

- Read all instructions before using the appliance.
- Do not run appliance while you are out of the home.
- Do not wash or dry articles that have been previously cleaned in, washed in, soaked in, or spotted with gasoline, dry-cleaning solvents, cooking oils, or other flammable or explosive substances because they give off vapors that could ignite or explode.
- Use only detergents and softeners for machine wash. Manufacturer may not assume responsibility for any damage and eventual discolouring of gaskets and plastic components as a consequence of incorrect use of bleach and/or colouring agents.
- Never use detergents containing solvents, since there is a danger of creating toxic gasses which may damage the machine and result in ignition or explosion.
- Do not allow children to play on or in the appliance. Close supervision of children is necessary when the appliance is used near children.
- Before the appliance is removed from service or discarded, remove the door to the washing compartment.
- Do not reach into the appliance if the drum is moving.
- Do not install or store this appliance where it will be exposed to the weather.
- Do not tamper with controls.
- Do not repair or replace any part of the appliance or attempt any servicing unless specifically recommended in the user-repair instructions or in published user-repair instructions that you understand and have the skills to carry out.

- Do not add gasoline, dry-cleaning solvents, or other flammable or explosive substances to the wash water. These substances give off vapors that could ignite or explode.
- Under certain conditions, hydrogen gas may be produced in a hot water system that has not been used for 2 weeks or more. **HYDROGEN GAS IS EXPLOSIVE.** If the hot water system has not been used for such a period, before using a washing machine or combination washer-dryer, turn on all water faucets and let the water flow from each for several minutes. This will release any accumulated hydrogen gas. As the gas is flammable, do not smoke or use an open flame during this time.

WARNING!



This appliance must be properly grounded. This manual does not cover every possible condition and situation that may occur. Use common sense and caution when installing, operating, and maintaining any appliance.

Important safety instructions



Grounding instructions

A) Grounding instructions for a grounded, cord-connected appliance:

In the event of malfunction or breakdown, grounding will reduce the risk of electric shock by providing a path of least resistance for electric current. This appliance is equipped with a cord having an equipment-grounding conductor and a grounding plug. The plug must be plugged into an appropriate outlet that is properly installed and grounded in accordance with all local codes and ordinances.

WARNING!



Improper connection of the equipment-grounding conductor can result in a risk of electric shock. Check with a qualified electrician or service representative or personnel if you are in doubt as to whether the appliance is properly grounded.

Do not modify the plug provided with the appliance.

If it will not fit the outlet, have a proper outlet installed by a qualified electrician.

B) Grounding instructions for a permanently connected appliance:

This appliance must be connected to a grounded metal, permanent wiring system, or an equipment-grounding conductor must be run with the circuit conductors and connected to the equipment-grounding terminal or lead on the appliance.

NOTE!

This manual does not cover every possible condition and situation that may occur. Use common sense and caution when installing, operating, and maintaining any appliance.

Installation

See the "Installation" chapter.

Overflow guard function

If the machine's water level rises above the normal level, the overflow guard function begins to pump water out and shuts off the water intake. If the water level has not dropped within 60 seconds, the program is terminated.

Transport/Winter storage

If the machine is to be transported or stored in unheated premises where the temperature can fall below freezing, do as follows:

- Empty the filter and the drain pump. See the "Care and maintenance instructions" chapter.
- Shut off the water to the washing machine, loosen the supply hose to the intake valve, and let the water run out from the valve and hose.
- After emptying the pump, a small amount of water may remain in the machine. This does not affect quality or damage the machine.

Disposal

When the machine has reached the end of its service life and is to be disposed of, it should immediately be made unusable by removing the door to the washing compartment. Contact your local authorities for information about where your machine should be disposed of and recycled in the proper way. The machine is manufactured and labeled for recycling.

WARNING!

This product may contain chemicals known to the state of California to cause cancer or reproductive harm.

SAVE THESE INSTRUCTIONS FOR FUTURE REFERENCE

Child safety

Keep an eye on children!

WARNING!



- Laundry detergents are corrosive, so always keep them out of reach of children.
- Should a child swallow detergent, give plenty to drink immediately, i.e., one or two glasses of milk or water. Do not try to induce vomiting. Seek medical advice immediately: The National Poison center phone number is 1-800-222-1222.
- Always close the door and start the appliance as soon as you put in the detergent.
- Always turn the power off to the machine when it is not in use.
- Always keep small children away from the machine when it is open. There may be some detergent residue left inside the machine.
- If laundry detergent gets in someone's eyes, rinse them with plenty of water for at least 15 minutes.

Activate child safety catch (for detergent compartment)

On the inside of the detergent compartment is a child safety catch.

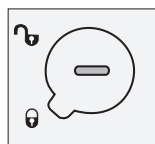

Activated child safety catch

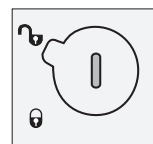

Inactivated child safety catch

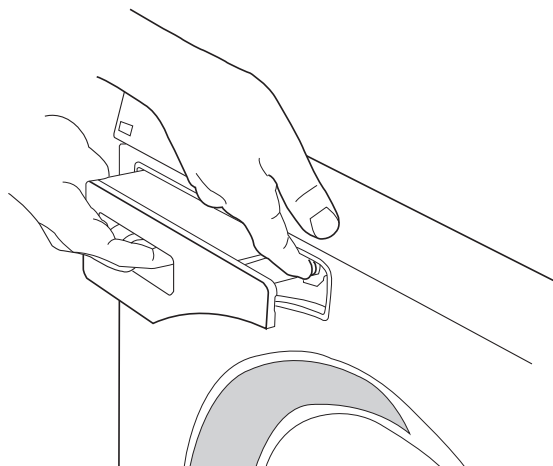

When the child safety catch is activated, you must press the release button to pull out the detergent compartment.

Parts of the washing machine

1. Main power switch
2. Dispenser
3. Program panel
4. Serial number plate (on inside of washer door)
5. Drain pump cover
6. Drain pump (behind cover)
7. Washer door

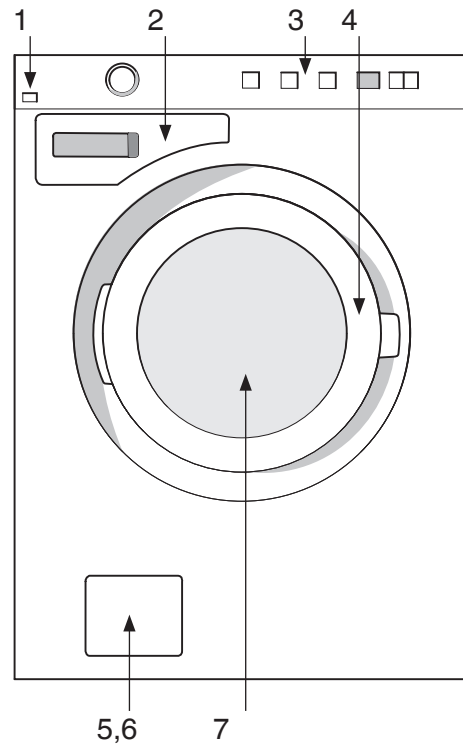

Dispenser

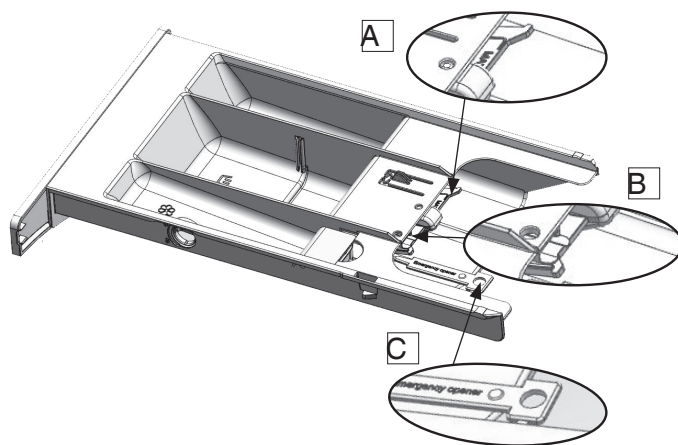
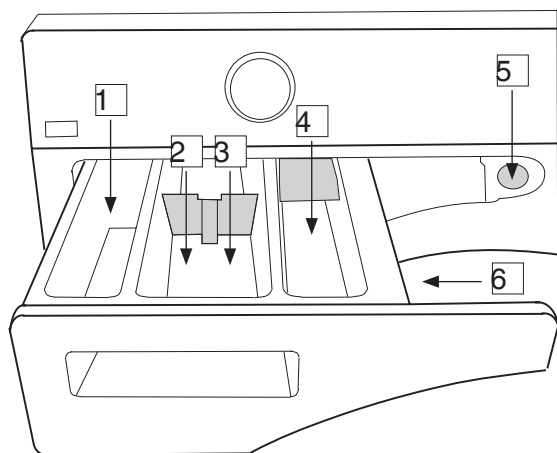

1. Pre Wash



2. Main wash with liquid detergent.
Use the separator (A).



3. Main wash with powder detergent.
Do not use the separator.



4. Fabric softener



5. Release button

6. Child safety catch

The detergent drawer automatically dispenses the detergent and fabric softener at the appropriate times.

Simply pour the measured amounts of detergent and softener into the proper compartments (as illustrated) and close the drawer.

NOTE!

To avoid oversudsing, do not put detergent in the prewash compartment unless you are using one of the Heavy wash programs which has a prewash cycle.

Advice and tips before washing

Here are some tips that may help you before washing.

Sorting your laundry

Sorting your laundry

- how soiled they are
- color
- material

Clothing

1. Close zippers and Velcro straps so they won't damage fabrics.
2. New colored items may contain excess dye and should therefore be washed separately the first few times.
3. Turn delicate items inside out. This reduces the risk of burling and fading.
4. Empty pockets and wash them inside out if possible.

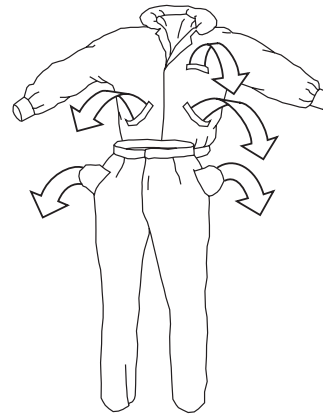







Laundry labels

Look at the item's laundry label. The table below shows suitable wash programs for different materials and wash loads. Using modern washing machines and detergents, such as compact detergents, you can usually wash at lower temperatures. It is a good idea to use trial and error to find out what produces the best results.





Laundry label symbols

Examples of washing instructions and recommended programs. Always follow the washing instructions for each garment.







Laundry labels	Material	Program
	Heavily soiled cotton, linen, white, and light-colored items.	Sani 140 °F (60 °C) to 203 °F (95 °C)
	Normally soiled cotton, linen, cotton/polyester. Light and dark-colored garments.	Quick 140 °F (60 °C)
	Polyester, polyamide, elastane, acrylic. Light and dark-colored garments.	PermaPress 104 °F (40 °C)
	Acrylic, viscose, modal, acetate.	Everyday Wear (Easy care) 104 °F (40 °C)
	Silk and very delicate items	Perma Press 86 °F (30 °C)
	Wool and other very delicate garments	Wool/Hand Wash 86 °F (30 °C) to 104 °F (40 °C)

Advice and tips before washing



Wash cycle

-  Normal wash cycle
-  Permanent Press or Wrinkle Resistant setting
-  Gentle/Delicate setting
-  Hand wash only
-  Do not wash
-  Do not wring. Hang dry, drip dry, or dry flat

Wash water temperature

-  Maximum water temp 200° F/95° C
-  Maximum water temp 160° F/70° C
-  Maximum water temp 140° F/60° C
-  Maximum water temp 120° F/50° C
-  Maximum water temp 105° F/40° C
-  Maximum water temp 85° F/30° C





Bleach instructions

-  Any bleach when needed
-  Only non-chlorine bleach
-  Do not bleach





Dry clean symbol

-  Dry clean only





Tumble dry cycle

-  Machine dry
-  Normal setting
-  Permanent Press or Wrinkle Resistant setting
-  Gentle or Delicate setting
-  Do not tumble dry







Tumble dry heat setting

-  Any heat
-  High heat
-  Medium heat
-  Low heat
-  No heat/Air fluff

Special drying instructions

-  Line dry or hang to dry
-  Drip dry (do not spin or wring)
-  Dry flat
-  Dry in shade

Ironing instructions

-  Ironing is necessary
-  High temperature setting
-  Medium temperature setting
-  Low temperature setting
-  Do not iron or press with heat
-  Iron without steam

Advice and tips before washing

Coloured cotton

Colored cotton items labeled 140 °F (60 °C) should be washed at 140 °F (60 °C) the first time in order to remove any excess dye. If you do not do so, there is a risk that the color will run. Use detergent without bleach in order to preserve the color of the fabric.

Unbleached linen

Unbleached linen fabrics should be washed at 140 °F (60 °C), using detergent containing no bleach or optical whiteners. Heavily-soiled linen can occasionally be washed at higher temperatures, but not too often as the heat can destroy the linen's sheen and strength.

Wool

These fabrics are labeled either machine wash or hand wash. The Wool/Hand Wash program is at least as gentle as washing by hand.

Wool is especially sensitive to processes such as washing.

If you do not wish to spin dry, you can squeeze out the water using terrycloth towels. In this case select No spin.

To find out how to choose this setting, see the "Operating instructions" chapter. However, most garments can withstand a short spin. Choose a short spin by selecting a spin speed of 800 rpm or less.

Rayon fibers and synthetic fibers

Materials made of rayon fibers, such as viscose, and some synthetic fibers are very delicate and require much space to avoid wrinkling. Only half fill the drum when washing and choose a spin speed of 800 rpm or lower.

NOTE!

Viscose and acetates are fragile when wet.

Reducing allergic reactions

The washing machine has a Super Rinse option. Use this for people with sensitive skin, such as those with allergies and small children.

Save time and energy

Use the Color program to save time and energy. This program has a shorter main wash than White, but is often sufficient for lightly soiled laundry.

Economy and efficiency

You can save a lot of energy by not using higher temperature programs than necessary.

- Select Quick if you just need to freshen up shirts or exercise clothes, for example. This will save both water and energy.
- If you select a fast spin speed, this reduces energy consumption when drying in a tumble dryer or drying cabinet.
- Always wash with a full load when using the Sani, Color, and White programs.
- Avoid pre-washing. Modern machines and detergents clean effectively without pre-washing. Pre-washing is only necessary for heavily soiled laundry.

Detergents

Eco-labeled detergents are less harmful to the environment.

Detergent overdosing does not give better washing results; it merely causes a greater impact on the environment.

Try to use less detergent, and increase only if you are not satisfied with the results.

Dyeing fabrics

If you want to dye fabrics in the machine, select the Color program with the Super Rinse option. Select the temperature according to the dye manufacturer's recommendations.

Choose a low spin speed if the fabric to be dyed is a blended material, such as polyester/cotton.

NOTE!

Add the dye directly to the washing drum – not to the detergent compartment. After dyeing, you should run the machine empty using the same program. Use the normal amount of detergent.

Advice and tips before washing

NOTE!

Due to environmental concerns, we discourage the use of strong chemicals.

When using agents for bleaching or stain removal, there is a risk of rust (corrosion) and discoloration of the machine.

Liquid detergents

We don't recommend liquid detergents because they tend to produce more suds than powder detergents when used in water temperatures of 150° F or higher.

If you should try a liquid detergent, start with a very small amount, such as 1 to 2 tablespoons. Also, liquid detergent can be used for all programs without prewash, so add it into the main wash compartment.

Detergents

Laundry detergents are available in low-, normal- and high-sudsing formulas. A detergent's ability to clean is not relative to the amount of suds it produces. Excess suds in a front-loading washer actually interfere with the cleaning because they cushion the tumbling action. Also, high-sudsing detergents are more difficult to completely rinse out. The use of anything other than a low-sudsing detergent can cause severe oversudsing, which could cause suds to backup through the detergent compartment and run down the front of the washer onto the floor. If oversudsing occurs, run the wash through one or more rinse programs until all items are thoroughly rinsed. Remove the laundry then run the washer through a Normal wash program to get rid of any remaining detergent.

We recommend that you don't use bleach in your ASKO washer. The tumbling wash action, temperature control options, extended wash times and proper amount of detergent are sufficient to remove most stains.

Recommended powder detergents

ASKO washers use 50% to 75% less detergent than most other washers. This is because of their low water consumption and the fact that all the wash water is repeatedly circulated through the laundry, ensuring that all the detergent is fully utilized. We recommend that you use powder detergents made specifically for front-loading washers. These are sometimes called HE (High-Efficiency) detergents. Please visit our homepage www.askona.com to see the powder detergents we recommend for ASKO washers. We recommend that you do not use any powder detergent that doesn't wash completely out of the detergent drawer.

Detergent Amounts Based on Water Hardness

The amount of detergent needed can vary due to differences in water hardness. To determine the water hardness in your area, contact your local water utility or area water softening company. The harder the water, the more detergent you may need. Refer to the chart below for the recommended detergent amounts based on water hardness. Remember, you should adjust the amount of detergent you use by small amounts until you find the correct amount.

Note that 12 grains and higher is extremely hard water and detergent alone may not be enough. You may need to use a water softener to maximize the performance of your washer. Also, in areas with hard water (9+) you may need to wash at lower temperatures to prevent hard water deposits from forming in the tank and wash system.

Amount of detergent to use

The amount of detergent needed varies among the different brands, but for most detergents, you need only one or two tablespoons. Using too much detergent can result in detergent residue being left in your clothes, which can cause them to appear gray or dingy. You should start with a small amount of detergent

Advice and tips before washing

and increase it only if the cleaning results are unsatisfactory.

Additionally, you should never put detergent in the prewash compartment unless you are using a wash program that has a prewash cycle. This could cause excess foaming, which could damage the machine.

The amount of detergent needed can also depend on the hardness of the water in your area. See the “Detergent Amounts Based on Water Hardness” section on the next page for more details.

Recommended detergent amounts based on water hardness

Detergent amounts		
Water hardness	Pre Wash	Main Wash
Soft (0-3 grains per gal.)	1 teaspoon	1 to 1-1/2 tablespoons
Medium (4-8 grains per gal.)	1 teaspoon	1 to 2 tablespoons
Hard (9+ grains per gal.)	1 teaspoon	2 to 3 tablespoons

Operating instructions

WARNING!



To reduce the risk of fire, electric shock, or injury to persons, read the **IMPORTANT SAFETY INSTRUCTIONS** before operating this appliance.

1 Sort your laundry.

See the "Advice and tips before washing" chapter.

Place underwired bras in a laundry net.

Empty pockets. Coins, nails, and the like can cause damage to the machine and fabrics. See the "Advice and Tips" section before washing.

2 Turn on the main power switch

NOTE!

Power on

Press the on/off button for min. 1 sec and max. 5 sec.

Power off

Press the on/off button for min. 5 sec.

If the ON/OFF command is not correctly accepted by the machine, wait min. 8 sec before any further press.

3 Open the washer door and load the laundry

If the washer door is closed, press the Door Opening button (key symbol). The door opens once all water has drained from the machine. Load the laundry. The wash program chart shows how much laundry can be washed with each program.

Operating instructions

4 Add detergent and fabric softener, as required

The detergent packaging will have recommendations for how much detergent you should use. The machine holds 18 lb (8 kg) of laundry. If you only have a small amount of laundry in the machine, you can reduce the amount of detergent used.

Powder detergent

Pour the powder into the main wash compartment, and pre-wash compartment as well if desired.

Liquid detergent

When using a liquid detergent, observe the detergent manufacturer's recommendations. We recommend using a laundry ball with thick detergents. In the main detergent compartment, use the section wall (A) – see figure in the section Dispenser. Add the detergent into the front compartment of the detergent dispenser.

Wash ball or net

If you use a wash ball or net, place it directly in the drum and select a program without pre-wash.

NOTE!

Detergent overdosing does not give better washing results; it merely causes a greater impact on the environment.

Try using less detergent, and increase only if you are not satisfied with the results.

Fabric softener

Pour the fabric softener into the compartment with the  symbol. Follow the recommendations on the fabric softener packaging.

NOTE!

Do not fill above the compartment's maximum fill level. Otherwise fabric softener will be

dispensed too early, which impairs the washing effect.

WARNING!



To reduce the risk of fire, electric shock, or injury to persons, read the IMPORTANT SAFETY INSTRUCTIONS before operating this appliance.

Operating instructions

5 Select the program

You select a program by turning the program selector. An LED lights up beside the selected program and the estimated program time appears on the display. Use the option buttons to select any options.

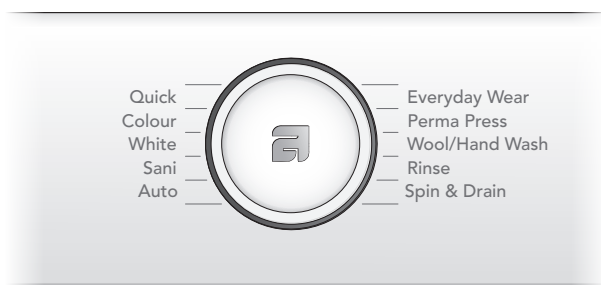

1. Auto

This program automatically adjusts the length of the main wash and the number of rinses to the amount of laundry loaded in the machine.

2. Sani

Program for heavily soiled laundry, with dirt that needs to be fully dissolved before the main wash. A pre-wash is used to do this. You can select the temperature freely, so follow the washing instructions for each garment. The highest temperature, 203°F (95°C), is suitable for very heavily soiled laundry. The spin speed can be selected freely. The machine adapts the program time and water consumption to the load size.

3. White

Program for normally to heavily soiled laundry, whites and colors. You can select the temperature freely, so follow the washing instructions for each garment. 140°F (60°C) is a good temperature for heavily soiled cotton garments, as well as for garments worn next to the skin. Select 104°F (40°C) if the laundry is less soiled. The spin speed can be selected freely. The machine adapts the program time and water consumption to the load size.

4. Color

A standard program for lightly to moderately soiled laundry. The temperature can be

selected freely, so follow the washing instructions for each garment. Garments worn next to the skin ought to be washed at 140 °F (60°C). Very lightly soiled laundry often comes clean already at 104°F (40°C). The spin speed can be selected freely. The machine adapts the program time and water consumption to the load size.

5. Quick

Program for normally soiled cotton and/or linen clothes for daily use. You can select "Cold" (incoming water temperature), 104°F (40°C), or 140°F (60°C). The lower the selected temperature, the shorter the program time. Garments worn next to the skin should be washed at 140°F (60°C).

6. Everyday Wear (Easy care)

Program for synthetics, mixed fiber, and easy care cotton. The program has a high water level and as such is also suitable for cushions, quilted jackets, and similar items. Read the washing instructions carefully and remember, for example, that fabric softener must not be used with the membranes found in some outer garments. A washing temperature up to 140°F (60°C) and a spin speed up to 1200 rpm can be selected.

7. Perma Press

Program for delicate garments made of synthetic fibers, mixed fibers, rayon, and easy care cotton. The maximum temperature is 140 °F (60°C), but follow the washing instructions for each garment. Many synthetics will come clean at 104°F (40°C). Garments worn next to the skin ought to be washed at 140 °F (60°C). The maximum spin speed is 800 rpm.

8. Wool/Hand Wash

A gentle laundry program for wool, silk, and garments that should be washed by hand. The highest temperature is 86 °F (30°C). This program has a short spin. The maximum spin speed is 800 rpm.

Operating instructions

9. Rinse

This program performs one cold rinse cycle + spin. Suitable for laundry that just needs to be dampened and for cleaning cloths and mops.

10. Spin & Drain

Used to just spin the load. If you only want to drain the machine of water, select the  symbol (no spin).

Operating instructions

Program chart

Program	Pre Wash	Temp. °F	Number of rinses	Spin Speed rpm	Max. load (lb)	Water consumption (approx. gallon)	Energy consumption (approx. kWh)	Program time (approx. hrs and min.)
1. Auto								
2. Sani	X	203	5	1200	18	22,5	2.2	2:45
	X	140	5	1200	18	19,8	1.1	2:40
3. White		140	3	1200	18	15,6	1.10	2:21
		104	3	1200	18	15,6	0.59	2:02
4. Color		140	3	1200	18	15,9	1.2	1:40
5. Quick		104	2	1200	9	6,6	0.4	0:40
6. Everyday Wear (Easy care)		32	2	1200	9	15,9	0.6	1:40
7. PermaPress		104	3	800	6	7,9	0.4	1:20
8. Wool/Hand Wash		86	3	800	6	18,5	0.5	0:50
9. Rinse			1	1200	9	4,0	0.1	0:18
10. Spin & Drain				1200	9		0.1	0:15

Operating instructions

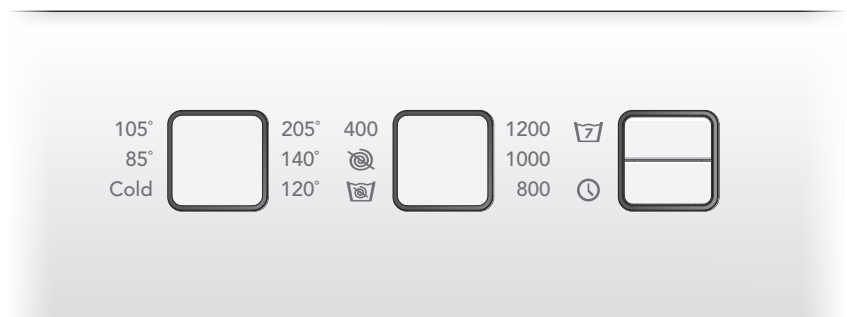

6 Select options

You can select options to adjust the wash program to suit your own specific requirements. The available options depend on the selected program. If the option is available for the selected program, the symbols light up when you press the button.

The machine will remember the options you select for each program (with one exception – Delayed Start). You can still change the selected options the next time you select a particular program.





Temperature

- Select the temperature by pressing the button until the LED by the correct temperature lights.
- You can select temperatures between 68°F (20°C) and 203°F (95°C). You cannot choose a temperature higher than 104°F (40°C) for Wool/Hand Wash. The maximum temperature for Perma Press or Everyday Wear (Easy care) is 140°F (60°C).



Spin

- Select the spin speed by pressing the button until the LED by the correct speed lights.
- You can select speeds between 400 and 1200 rpm, No spin, or No drain. The maximum spin speed varies according to the selected program, so check the LEDs around the button.
-  , means that the program does not include a spin cycle and ends by draining.

-  No drain means that the program does not include a spin cycle and ends with the water from the final rinse still in the machine. The washing will remain covered by the water from the final rinse, stopping it from getting wrinkled. If you have selected "No drain", you must select the Spin & Drain program and the  symbol (no spin) once the program has ended to drain the water from the machine before you open the washer door.

Super Rinse

Use the Super Rinse option if you want to increase the number of rinses. The maximum number of rinses is seven and varies depending on the selected program. Recommended for persons with extremely sensitive skin and/or in areas with very soft water. This option cannot be selected with Quick, Rinse, or Spin & Drain.

- Select Super Rinse by pressing the button under the symbol.
- An LED next to the button lights when this option is activated.

Delayed start

When you select Delayed Start, the machine will start 1-24 hours after you press the Start/Stop button.

- Press the button by the symbol to activate Delayed Start.
- By pressing the button again, you can delay the start in whole hours up to a maximum of 24 hours.

Operating instructions

- Press Start/Stop and the machine will count down 1 hour at a time, starting after the selected delay.

If you change your mind and want to cancel Delayed Start, press and hold Start/Stop for three seconds.

NOTE!

Remember to press the Start/Stop button to start the program.

NOTE!

Make sure the detergent compartment is completely dry before you add detergent, otherwise there is a risk that the detergent will clump before the machine starts.

7 Close the washer door and press the Start/Stop button

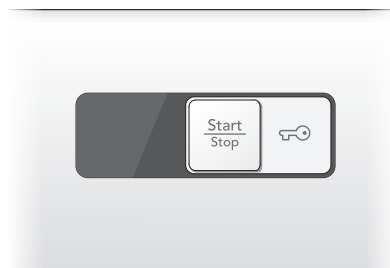

Time remaining

When the program starts, an estimated program time, in hours and minutes, is displayed. The remaining time is updated three times during the program, based on the actual load and the incoming water temperature. The first update takes place after about 15 minutes. The remaining time is last updated just before the final rinse.

To add or remove laundry after the program starts

If you want to add or remove items after the program has started, you can stop the program by pressing and holding the Door Opening button (key symbol) for three seconds. The program time flashes on the display. When you restart the machine, add any extra detergent needed and close the washer door. The machine continues automatically from the point where the program was interrupted.

Stopping or changing a program

You can stop a program by pressing the Start/Stop button for three seconds. To restart the machine, select a new program, add any extra detergent needed, and press the Start/Stop button.

NOTE!

Do not open the detergent compartment while the machine is running.

Operating instructions

8 Once the program has finished

The text "End" is shown on the display for 2 minutes. The machine then turns off.

The washer door opens automatically once the program has finished. If you want to deactivate the Automatic Door Opening function, see the "Selecting settings" section.

- Remove the laundry.

If you have small children or pets at home, close the washer door once you have removed the laundry.

NOTE!

Upon completion of the washing cycle, close the water faucet and unplug the mains cord.

Settings

You can change the following settings:

Automatic Door Opening.
Extra rinses.

Door opening

If you choose Automatic Door Opening, the washer door will open once the program has finished.

1. Turn off the machine using the main power switch.
2. Press and hold the Super Rinse button and then switch on the main power switch.
3. "AdO" is shown on the display if automatic door opening is activated or "AdF" if this option has not been activated.
4. Press the Super Rinse button to change the setting.
5. Press the Door Opening button to save the setting.

Extra rinses

Upon delivery, your washing machine is set to use three rinses in the White and Color programs. If you want to increase the number of rinses to five for these programs, do as follows:

1. Turn off the machine using the main power switch.
2. Press and hold the Delayed Start button and then switch on the main power switch.
3. The display shows "R O" if extra rinses is activated (5 rinses), or "R F" if it is not activated (3 rinses).
4. Turn the program selector to change the setting.
5. Press the Door Opening button to save the setting.

Care and maintenance instructions

Cleaning the trap and the drain pump

The washing machine has a trap where small items such as coins, buttons, and hairpins can collect. To clean the trap and the drain pump, do as follows:

1. Make sure the machine is empty of water and switched off at the main power switch.

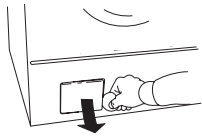

2. Open the door.

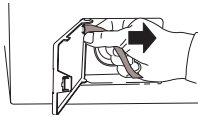

3. Unhook the drain hose from the connector inside the door and drain the water into a suitable container, such as a shallow bowl.

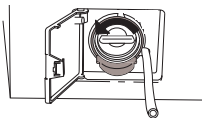

4. Turn the cover counter-clockwise to open the pump. Remove the cover.

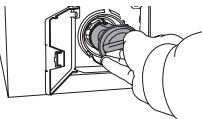

5. Remove any items and debris from the pump housing and cover. Also check that the pump impellers at the back rotate.

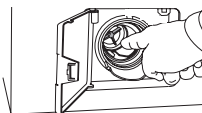

6. Screw on the cover, replace the drainage hose on the hatch pin, and close the hatch.

Cleaning the detergent compartment

Pull out the detergent compartment using the release button.

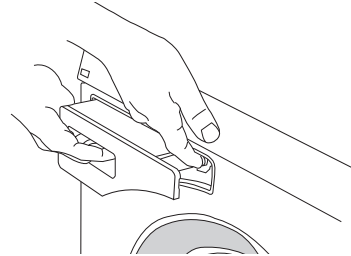

Rinse the compartment and scrub it clean. The cover in the fabric softener compartment can be removed.

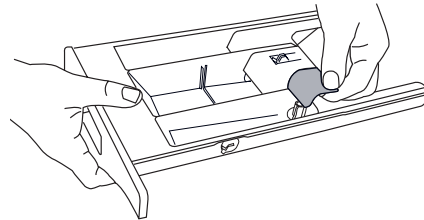

NOTE!

Do not run the detergent compartment through a dishwasher!

Cleaning the outside of the machine

Clean the outside of the machine and the program panel with a mild cleaner. Do not use any solvents, as these can damage the machine.

NOTE!

Do not hose down the machine with water!

Care and maintenance instructions

Cleaning the inside of the machine to avoid unpleasant smells

Modern detergents often allow laundry to be washed at low temperatures. This means that small deposits can build up in the machine. These, in turn, may lead to unpleasant odors developing.

To avoid this, we recommend running a 203 °F (95°C) wash program once a month. When you do this, use a small quantity of detergent. It is not necessary to put any laundry in the machine.

Rinse holes under the paddle

If you suspect that objects such as nails or paper clips may have fallen into the wash drum, you should check the space under the paddles. Such objects can rust and cause spots on clothing. Nails and other sharp objects can cause holes in fabrics.

Do as follows:

1. Insert a screwdriver or similar tool into the hole on the paddle as illustrated and carefully push to the left.

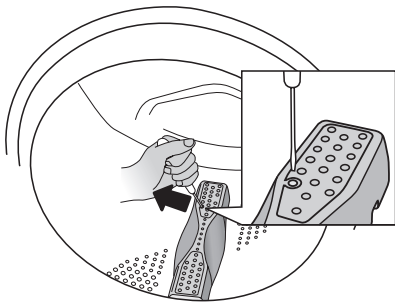

2. Use your other hand to grasp the paddle and pull it toward you.

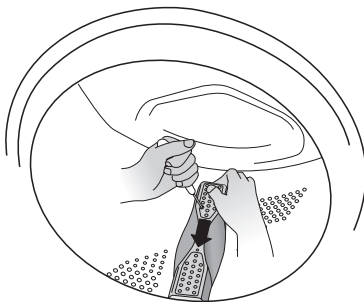

3. Lift the paddle.
4. Remove any objects.
5. Place the paddle in the mounting hole with the F-mark toward you. Ensure that all the paddle fasteners are in their holes in the drum. Push it in until it catches.

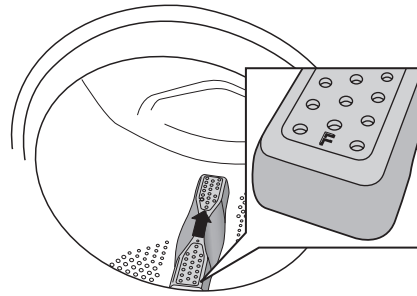

If you have hard water

If you live in an area with hard water (high limescale content), a grayish-white coating may form on the wash drum. To remove this coating, pour approximately 20 gram (1 oz) of citric acid into the wash drum and run any 203°F (95°C) program. Repeat if necessary.

Troubleshooting

The washer door will not open

1. Check that the main power switch is on.
2. Is there power? Check your home's fuses (circuit breakers). The washer door cannot be opened with the door opening button (with the key symbol) if the power is off.

If nothing else works, the washer door can be opened as follows:

WARNING!



The door may only be opened manually if the electric power is cut and the machine has been drained of water.

- A Select the Spin & Drain program and the option with the  symbol (no spin) to drain the water from the machine. If this does not work, the machine must be drained manually. See "Cleaning the trap and the drain pump" in the "Care and maintenance instructions" chapter.
- B Ensure that the main power switch is turned off and that the plug has been removed from the wall socket.
- C Take the emergency door opening key (C) (see figure in the section Dispenser) and insert it into the slot on the right-hand side of the washing machine door latch. The key is attached on the back wall of the detergent dispenser. Remove the detergent dispenser from the washing machine and take the door opening key.

- D Push the tool upward to open the washer door.

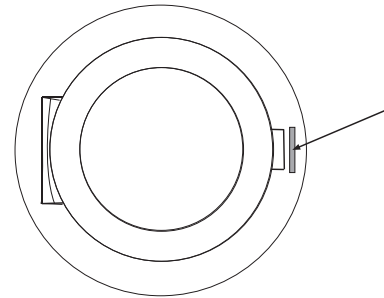

After use, store the emergency door opening key (C) in the dedicated compartment (B) (see image in the section Dispenser).

If in the future the washer door does not open when the wash program has finished, call the Customer Care Center.

The machine will not start

1. Is the washer door properly closed? Push it firmly.
2. Is there power? Check the fuses and residual current devices (circuit breakers) in the building.
3. Check that you have not selected Delayed Start. To cancel Delayed Start, press the Start/Stop button for three seconds.

After power failure

Press the main power switch to resume the current program.

Wet laundry still in the machine

A small load can under certain circumstances cause imbalance (see "Imbalance"). Rearrange the load and start the spin program, or load more laundry and restart the washing program.

Troubleshooting

Error messages

If an error occurs during the program, a message is shown on the display. To exit the message after taking action, turn the machine off and then back on.

The error messages that may be shown in the display are:

F10 Overfilling

1. Shut off the water tap.
2. See "F11 Drainage error".

F11 Drainage error

Check:

- that no objects are stuck in the drainage hose outlet.
- that the drain pump is not blocked by foreign objects. Clean the pump. See the "Care and maintenance instructions" chapter.
- that there are no kinks in the drainage hose.

After taking action, run the Drain program or press the Door Opening button (key symbol) to empty the machine. If this does not resolve the problem, call the Customer Care Center.

F12 Water Inlet Fault

Check:

- that the tap on the water pipe is open.
- that the filter in the machine's water intake is not blocked.

Action:

1. Shut off the water tap.
2. Unscrew the hose.
3. Clean the filter in the intake valve on the machine.
4. Screw the hose back on.
5. Turn on the tap.
6. Run the program again to check whether the error has been fixed.
7. If this does not resolve the problem, call the Customer Care Center.

Imbalance

The machine stops the spin cycle if there is too much imbalance. The washing machine restarts the spin cycle and hopefully the laundry is better distributed in the drum. This procedure can be repeated up to 10 times. If the machine still fails to find a good balance, the program jumps to the next step.

The error message requires no action.

Technical information

Technical data

Height:	33 1/2" (850 mm)
Width:	23 1/2" (597 mm)
Depth:	23 7/8" (606 mm)
Weight:	161 lb (73 kg)
Cylinder volume:	15,9 gal (60 l)
Max. laundry capacity:	18 lb (8 kg)
Spin speed (rpm):	400-1200
Rated power:	See serial number tag and rating plate.
Heater output:	See serial number tag and rating plate.
Water pressure:	14-145 psi
Wash drum and liquid compartment material:	Stainless steel
Outer casing material:	Powder-coated and hot-galvanized sheet steel or stainless steel.
Water connection:	59" (1.5 m) pex pipe
Drain:	67" (1.7 m) polypropylene hose

Transport protection

Remove the three transport bolts and the plastic plugs for locking the machine for transport before using the machine.

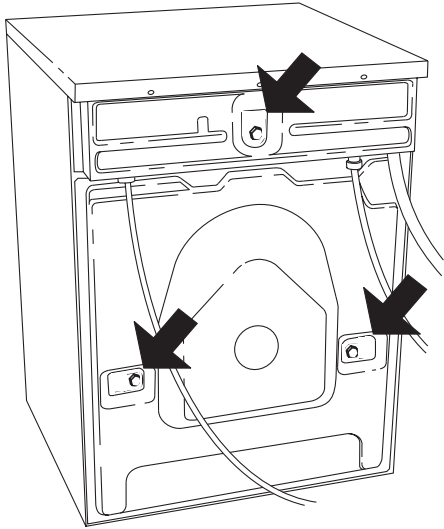

1. Loosen and remove the bolts as illustrated below.

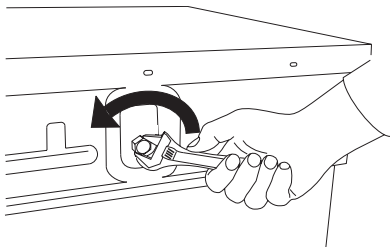

2. To remove the plastic plugs that held the bolts, squeeze together and pull out.

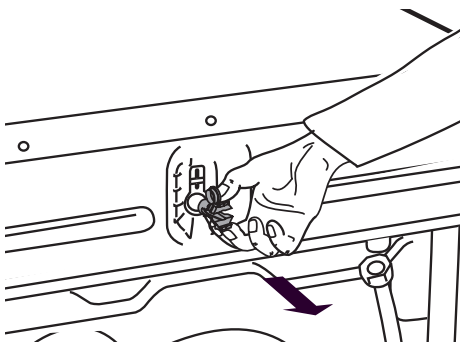

3. Remove the plastic covers from the plugs. Push the plastic covers into the three holes that contained the plugs. Save the plastic plugs in case the machine is moved in the future.

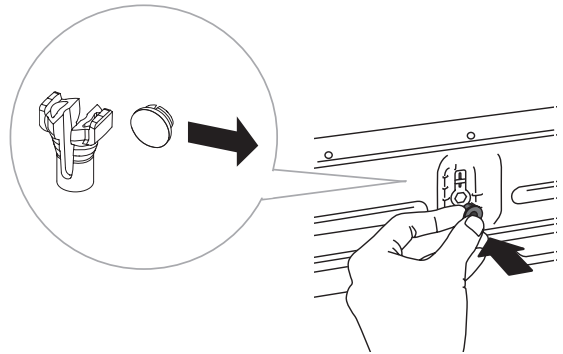

NOTE!

If the machine is to be transported, the bolts and plastic plugs for locking the machine during transport must be installed to prevent damage to the machine through shaking. If the transport bolts or plastic plugs have been lost, you can order new ones from your retailer.

Article number	Designation
80 882 77	Screw
80 901 05	Plastic plug, transport lock

Order three of each item!

Installation

Read these instructions carefully and completely before you install the machine. The installation should be carried out by a qualified person who is familiar with all local codes and ordinances for electrical and plumbing connections.

Cosmetic damage must be reported to your dealer within five days from the date of purchase. After unpacking the washer, thoroughly check the unit for cosmetic damage.

Leveling the machine

It is important that the machine is level to prevent excessive vibrations during spin cycles. Each foot of the washer is adjustable, so you can level the washer on any surface. Once it is level, securely tighten the lock nuts on the feet to prevent excessive vibration during spin cycles.

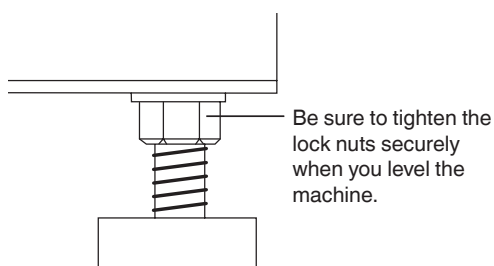

Water supply connection

Since ASKO washers have a built-in heating element, you only need a cold water inlet. The connection should be made by someone who is sufficiently skilled. Use the hose supplied with the washer. (The inlet hose is marked for correct connection.) The water pressure must be in the range 15–146 PSI. A valve should be fitted on the water supply pipe. If a new supply pipe has been installed for the washer, it should be flushed thoroughly to remove any foreign particles that might clog the filter in the fill valve.

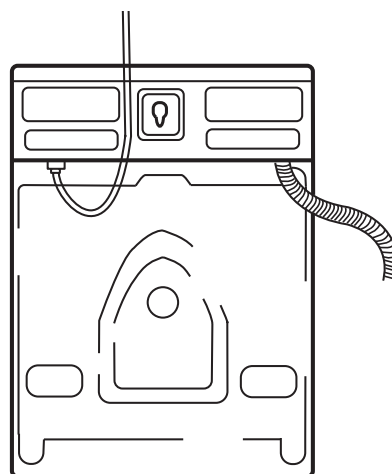

NOTE!

If the unit is installed on a second storey, follow local building codes. We recommend installing a drip pan.

Installation

Drain outlet connection

The machine is supplied with the outlet hose already attached. The hose should be extended over a suitable sink edge or drain pipe at a height of 24" to 36" (610 mm to 914 mm) above the bottom of the unit. (The lower height is preferable.) Make sure the hose is not kinked.



NOTE!

If the hose is extended, the internal diameter of the coupling must not be less than 1/2".

WARNING!



Do not extend the drain hose higher than 36" (914 mm) from the bottom of the unit.

Electrical Connections

The machine is delivered ready-fitted with a plug and is intended for connection to an ASKO Dryer, which is equipped with a matching receptacle. The plug supplied with the washer can only be used with an ASKO Dryer. If the washer is used separately or with another dryer, it must be on a separate 208-240 V single-phase circuit.

If the machine is to be used in a wet area, the supply must be protected by a residual current device.

As supplied: 208-240 V, 60 Hz, 2000W heating element, 15A fuse required.

WARNING!



Connection to a permanently wired supply point must be made only by a qualified electrician

Grounding instructions

This appliance must be grounded. In the event of malfunction or breakdown, grounding will reduce the risk of electric shock by providing a path of least resistance for electric current. This appliance is equipped with a cord having an equipment-grounding conductor and a grounding plug. The plug must be plugged into an appropriate outlet that is properly installed and grounded in accordance with all local codes and ordinances.

Freestanding installation

The washer can be placed next to the dryer. It is essential that the machine is leveled and the locknuts are tightened to prevent excessive vibration during spin cycles. Also be sure to leave a minimum of 1/2" of space between the washer and the dryer. The height adjustment for the washer is 33 1/2" to 34 1/2" (850 mm to 876 mm). Do not raise it higher than 34 1/2" (876 mm).

WARNING!



Improper connection of the equipment-grounding conductor can result in a risk of electric shock. Check with a qualified electrician or serviceman if you are in doubt as to whether the appliance is properly grounded.

Do not modify the plug provided with the appliance.

If it will not fit the outlet, have a proper outlet installed by a qualified electrician.

Stacked installation

ASKO washers should never be stacked on a counter or a dryer. You can, however, stack an ASKO dryer on an ASKO washer. Refer to your Dryer Use and Care Guide for instructions on how to do this.

Installation

Built-in installation

ASKO washers can be installed beneath a cabinet or worktop with a height of 34" to 35" (863 to 889 mm) or in a closet. There must be a gap of about 1/2" (12 mm) all around the machine, including between the rear edge of the machine's top panel and the back wall. The opening width must be at least 24 1/2" (622 mm). Space must also be available for the fill and drain hoses. See the illustration below for measurements and positions. If the washer is installed in a closet the door must be left open while the washer is running.

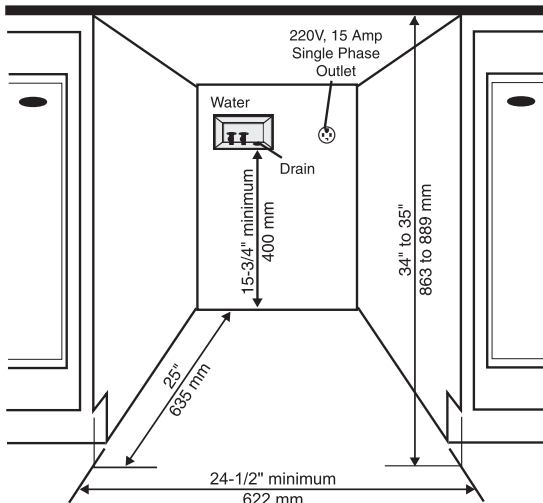

If the drain outlet is higher than 24" (610 mm), the connections will need to be recessed.

Service

Limited Warranty – Residential Appliances

ASKO Distribution North America, LLC. (“ASKO”) warrants to the original purchaser (the “ASKO Customer”) of the ASKO product (the “ASKO Product”), who purchased the ASKO Product from a distributor, dealer, manufacturer’s representative or other seller who has been authorized by ASKO, that this ASKO Product is free of defects in materials and/or workmanship, subject to the terms and conditions set forth herein. This Limited Warranty covers parts and labor, except as set forth in this Limited Warranty. Service must be provided by an authorized ASKO service company. YOUR SOLE AND EXCLUSIVE REMEDY UNDER THIS LIMITED WARRANTY SHALL BE PRODUCT REPAIR AS PROVIDED HEREIN. This Limited Warranty is valid only when the ASKO Product is used in the country in which it was purchased. Proof of original purchase date is required to obtain service under this Limited Warranty.

Residential ASKO Products Used Exclusively for Household/Personal Purposes:

Two (2) Years limited Warranty – Any warranty service claims for residential ASKO Products must be filed with ASKO within two (2) years from date of purchase. Service will be provided during normal business hours.

Residential ASKO Products Not Used Exclusively for Household/Personal Purposes or used Commercially or used in Marine, Mobile or Aeronautical Applications:

One (1) Year limited Warranty – Any warranty service claims for ASKO Products not used exclusively for household and personal use, or used commercially or used in marine, mobile, or aeronautical applications must be filed with ASKO within one (1) year from date of purchase. Service will be provided during normal business hours.

ITEMS EXCLUDED FROM WARRANTY

This limited warranty does not cover:

1. Replacement parts or repair labor if the ASKO Product is used in a manner that is inconsistent with published user or operator instructions and/or installation instructions.
2. Service calls to correct the installation of the ASKO Product, to instruct you on how to use the ASKO Product, to replace or repair house fuses, or to correct house wiring or plumbing.
3. Consumable items and parts, such as filters.
4. Damage resulting from accident, alteration, misuse, abuse, negligence, fire, flood, acts of God, improper use, improper installation, installation not in accordance with electrical or plumbing codes, or use of products not approved by ASKO, as well as any attempted repair by other than authorized ASKO service companies.
5. Cosmetic damage, including scratches, dents, chips or other damage to the finish of the ASKO Product, unless such damage results from defects in materials or workmanship and is reported to ASKO within 5 days from date of purchase.
6. Pickup and delivery. The ASKO Product is intended to be repaired in your home.
7. Repairs to parts or systems resulting from unauthorized modifications made to the ASKO Product.
8. Expenses for travel and transportation for product service if the ASKO Product is located in a remote area where service by an authorized ASKO service company is not available.
9. The removal and reinstallation of the ASKO Product if it is installed in an inaccessible location or is not installed in accordance with ASKO’s published installation instructions.
10. Replacement parts or repair labor on ASKO Products with original model/serial numbers that have been removed, altered or cannot be easily determined.

Service

DISCLAIMER

YOUR SOLE AND EXCLUSIVE REMEDY UNDER THIS LIMITED WARRANTY SHALL BE PRODUCT REPAIR AS PROVIDED HEREIN. EXPRESSLY DISCLAIMED ARE ALL OTHER EXPRESS AND IMPLIED WARRANTIES, INCLUDING ANY IMPLIED WARRANTIES OF MERCHANTABILITY AND FITNESS FOR A PARTICULAR PURPOSE. Some jurisdictions do not allow exclusion or limitations regarding warranty rights. This Limited Warranty gives you specific legal rights and you may have other rights that vary from jurisdiction to jurisdiction. Attempted repair by any person other than an authorized ASKO service company will void this Limited Warranty.

LIMITATION OF LIABILITY

IN NO EVENT SHALL ASKO OR THE MANUFACTURER AND THEIR RESPECTIVE PARENTS, SUBSIDIARIES AND AFFILIATES BE LIABLE FOR CONSEQUENTIAL, INCIDENTAL, EXEMPLARY, PUNITIVE OR SPECIAL DAMAGES. IN NO EVENT SHALL ASKO OR THE MANUFACTURER AND THEIR RESPECTIVE PARENTS, SUBSIDIARIES AND AFFILIATES BE LIABLE FOR DAMAGES OTHER THAN ACTUAL DAMAGES AND IN NO EVENT FOR DAMAGES IN EXCESS OF THE PRICE PAID FOR THE ASKO PRODUCT AS TO WHICH A CLAIM IS MADE. Some jurisdictions do not allow the exclusion or limitation of incidental, consequential or other damages, so these limitations and exclusions may not apply to you. This Limited Warranty gives you specific legal rights. You also may have other rights that vary from jurisdiction to jurisdiction.

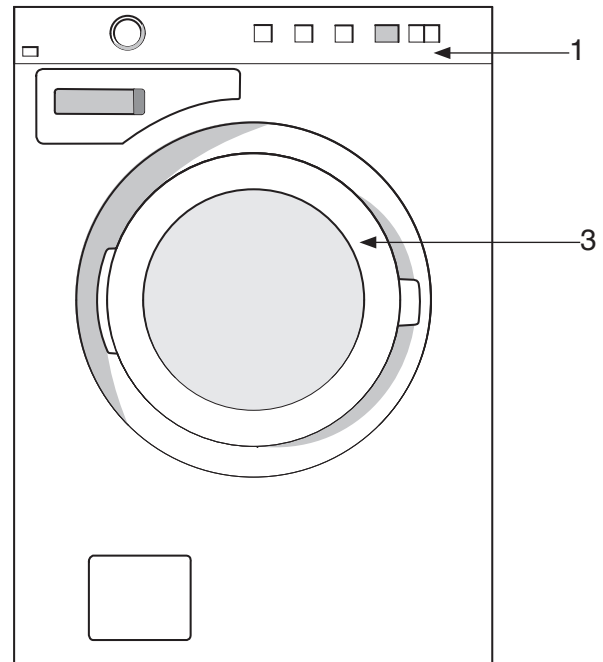

TROUBLESHOOTING & ASKO CUSTOMER CARE

If you think you need repair service, first see the “Troubleshooting” section of the Use & Care Guide. If you are unable to resolve the problem after checking “Troubleshooting,” then additional help can be obtained by calling ASKO Customer Care at 1-800-898-1879. Read the “Troubleshooting” chapter before contacting the Customer Care Center. Make a note of the (1) service number, (2) item number and (3) serial number.

A rectangular box containing three rows of text with corresponding shaded input fields. The first row is labeled 'Service no.' with a shaded box and a vertical line pointing to the number '1' above it. The second row is labeled 'ART. NO.' with a shaded box and a vertical line pointing to the number '2' above it. The third row is labeled 'SERIAL NO.' with a shaded box and a vertical line pointing to the number '3' below it.

Service

SERVICE AFTER EXPIRATION OF LIMITED WARRANTY

For information about obtaining parts and labor after expiration of this Limited Warranty or arising outside the scope of this Limited Warranty, please contact ASKO Customer Care at 1-800-898-1879. After your purchase and prior to first use of the ASKO Product, register your ASKO Product with ASKO by utilizing the address information below. Should you need further assistance as well, contact us at the address information below:

ASKO Distribution North America, LLC
Customer Care Center
PO Box 44848
MADISON WI 53744
1-800- 898-1879
www.askona.com

Notes

Notes

Notes

QUICK GUIDE

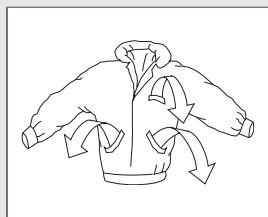

1.

SORT THE WASHING, OPEN THE WASHER DOOR AND LOAD THE WASHING

Refasten zips.

Look at the item's laundry label.

Sort the washing according to how soiled it is, colour and material.

NB! Place underwired bras in a laundry net.

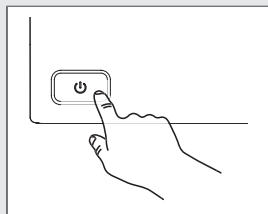

2.

TURN ON THE MAIN POWER SWITCH

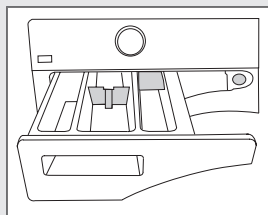

3.

ADD DETERGENT AND FABRIC SOFTENER, AS REQUIRED

The detergent packaging will have recommendations for how much detergent you should use. With only a small amount of washing in the machine, you can reduce the amount of detergent used.

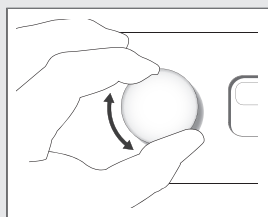

4.

SELECT A PROGRAMME

You select a programme by turning the programme selector.

The selected programme is shown in the display.

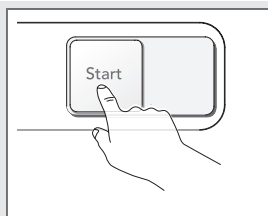

5.

CLOSE THE WASHER DOOR AND PRESS THE START BUTTON

The time remaining is shown in hours and minutes.

We reserve the right to make changes.

ASKO

Swedish quality since 1950

www.askona.com

