

NAPOLEON

CREATE A 5-STAR MEAL
WITHOUT LEAVING HOME.



OASIS™ / BUILT-IN SERIES
napoleongrills.com



YOUR INDOOR KITCHEN WILL WONDER WHERE YOU'VE BEEN. DON'T WORRY, WE WON'T TELL.

You view perfect grill marks as a badge of honor.

You think cutting into a steak to check doneness is sacrilege.

You know when and why to use rub vs. marinade vs. sauce.

That's why you are ready for a Napoleon grill. Napoleon takes the art of grilling to a higher level.

Every feature, every material is engineered to give ultimate performance — so you can create unforgettable meals.

And just like you, we're not some rookie behind the grill. Napoleon is a family-owned company with over 20 passionate years of grill-making experience.

Every great meal starts with the best ingredients. Start yours with the best grill out there: Napoleon



Table of Contents:

Prestige PRO™ BIPRO825RBI	4
Prestige PRO™ BIPRO665RB	5
Prestige PRO™ BIPRO500RB	6
Prestige® BIP500RB	7
LEX BILEX730RBI / BILEX605RBI	8
LEX BILEX485	9
Oasis™ Modular Islands	10 -11
Oasis™ & Built In Components	12 -13
Grilling Accessories	14 -15
Cooking Methods	15
Charcoal on a Gas Grill	16
Infrared Cooking	17
Installation	18 20
Built-in Heads	19
Specifications	21



We are proud to be recognized as one of Canada's Best Managed Companies and are dedicated to providing quality, home comfort products for over 38 years and counting.

PRESTIGE PRO™

BIPR0825RBI with rear infrared burner, infrared **SIZZLE ZONE™** bottom burners and smoker tray

106,000 BTU's
9 burners
Cooking Area: 1245 in² (8140 cm²)
Cart model available

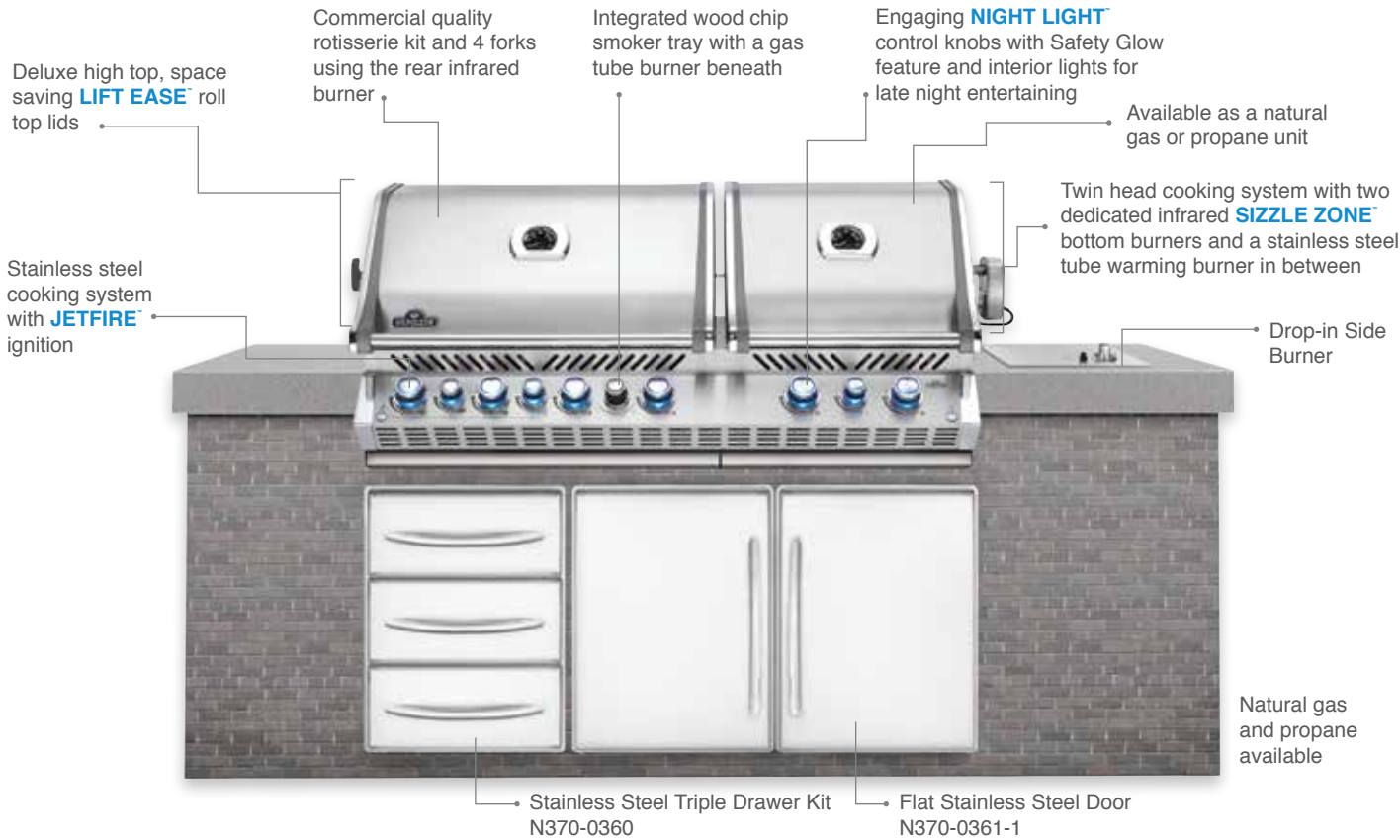

Doors and drawers are optional. Island not included.

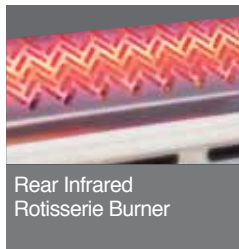
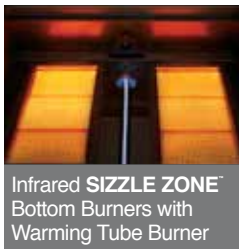

Proudly Made in Canada



NEW

PATENT PENDING

SAFETYGLOW CONTROL KNOBS

Blue **NIGHT LIGHT™** in off position and Red SafetyGlow when a burner is in use.
Entertain with peace of mind knowing that you will never accidentally leave the gas on.

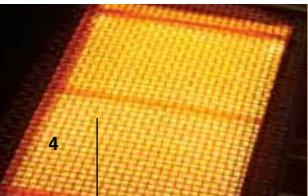

INFRARED TECHNOLOGY

The intense heat of Napoleon's infrared technology instantly locks in the juices for an amazing taste sensation! Over 11,000 flame ports produce up to 1800°F for optimum searing. See page 17 for more details.



PRESTIGE PRO™

BIPRO665RB with rear infrared burner, and integrated smoker tray

86,000 BTU's
 7 burners
 Cooking Area: 1000 in² (6510 cm²)
 Cart model available

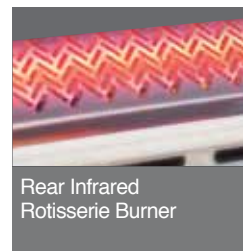
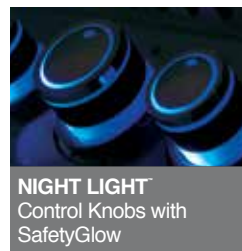
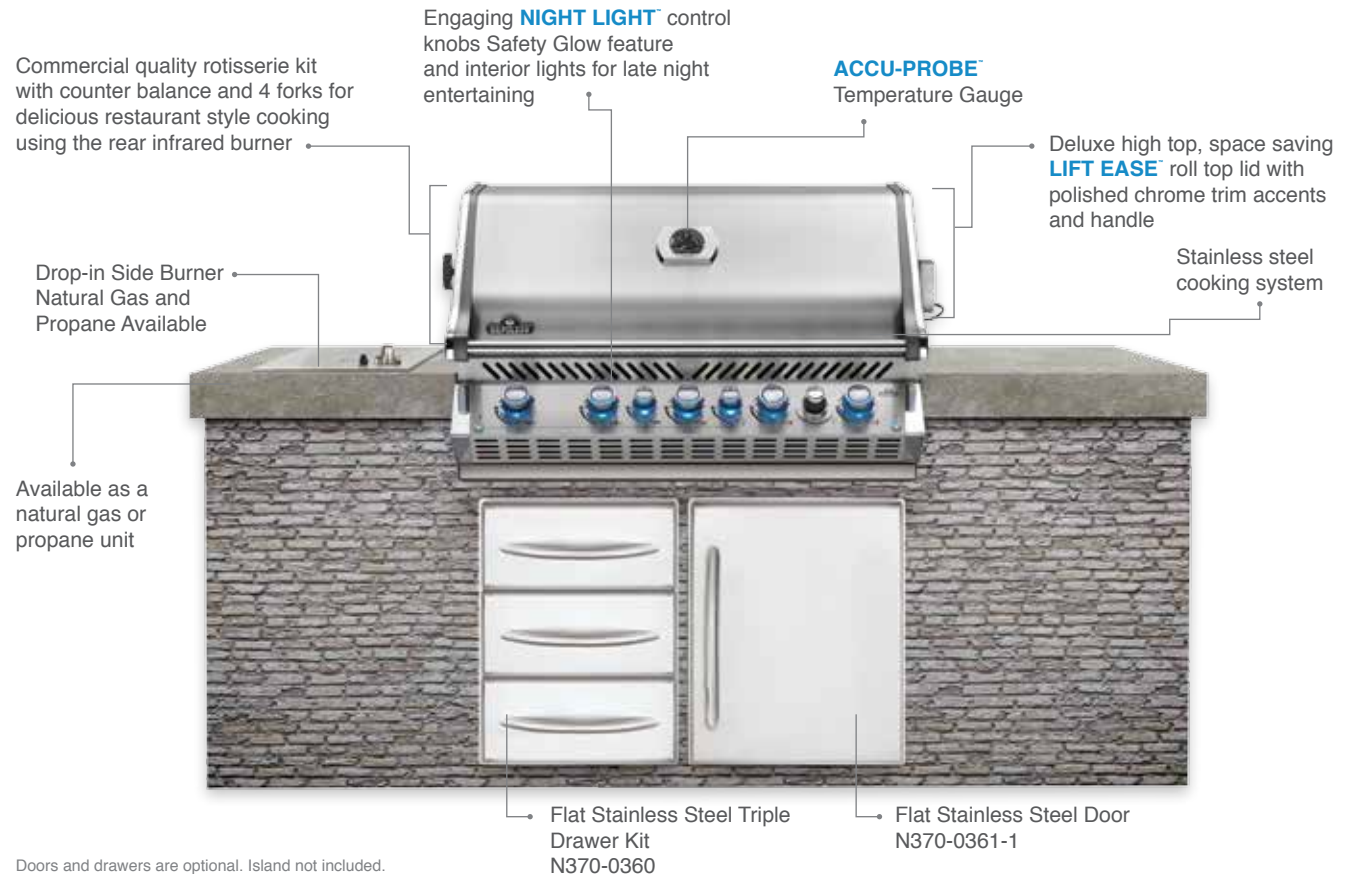

Proudly Made in Canada

CHARCOAL FLAVOR FROM YOUR GAS GRILL

Napoleon's optional charcoal tray is designed to let you add the fun & flavor of charcoal any time, on your gas grill. Simply replace sear plates with the charcoal tray, add charcoal and light with your gas burner. For more details see page 16.



PRESTIGE PRO™

BIPR0500RB with rear infrared burner

66,000 BTU's

5 burners

Cooking Area: 760 in² (4880 cm²)

Cart model available

Heavy duty rotisserie kit with counter balance and 2 forks for delicious restaurant style cooking using the rear infrared burner

Heavy gauge, long lasting stainless steel tube burners with crossover lighting

Available as a natural gas or propane unit

Deluxe high top, space saving **LIFT EASE™** roll top lid with polished chrome trim accents and handle

Engaging **NIGHT LIGHT™** backlit control knobs for late night entertaining

Drop-in Side Burner
Natural Gas and Propane Available



Flush Mount Stainless Steel Double Door N370-0502-1

Doors and drawers are optional. Island not included.



9.5 mm Stainless Steel **WAVE™** Cooking Grids

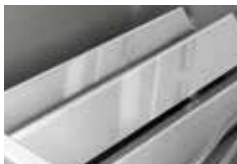

Dual-Level, Stainless Steel Sear Plates



NIGHT LIGHT™ Backlit Control Knobs with SafetyGlow



Rear Infrared Rotisserie Burner



Proudly Made in Canada



HEAVY DUTY STAINLESS STEEL COOKING SYSTEM

The even, consistent heat from high and hot to low and slow. **WAVE™** cooking grids for those trademark Napoleon sear lines, self cleaning sear plates for reduced flare-ups and durable burners for controlled, even heat.



PRESTIGE® BIP500RB with rear infrared burner

66,000 BTU's
5 burners
Cooking Area: 760 in² (4880 cm²)
Cart model available

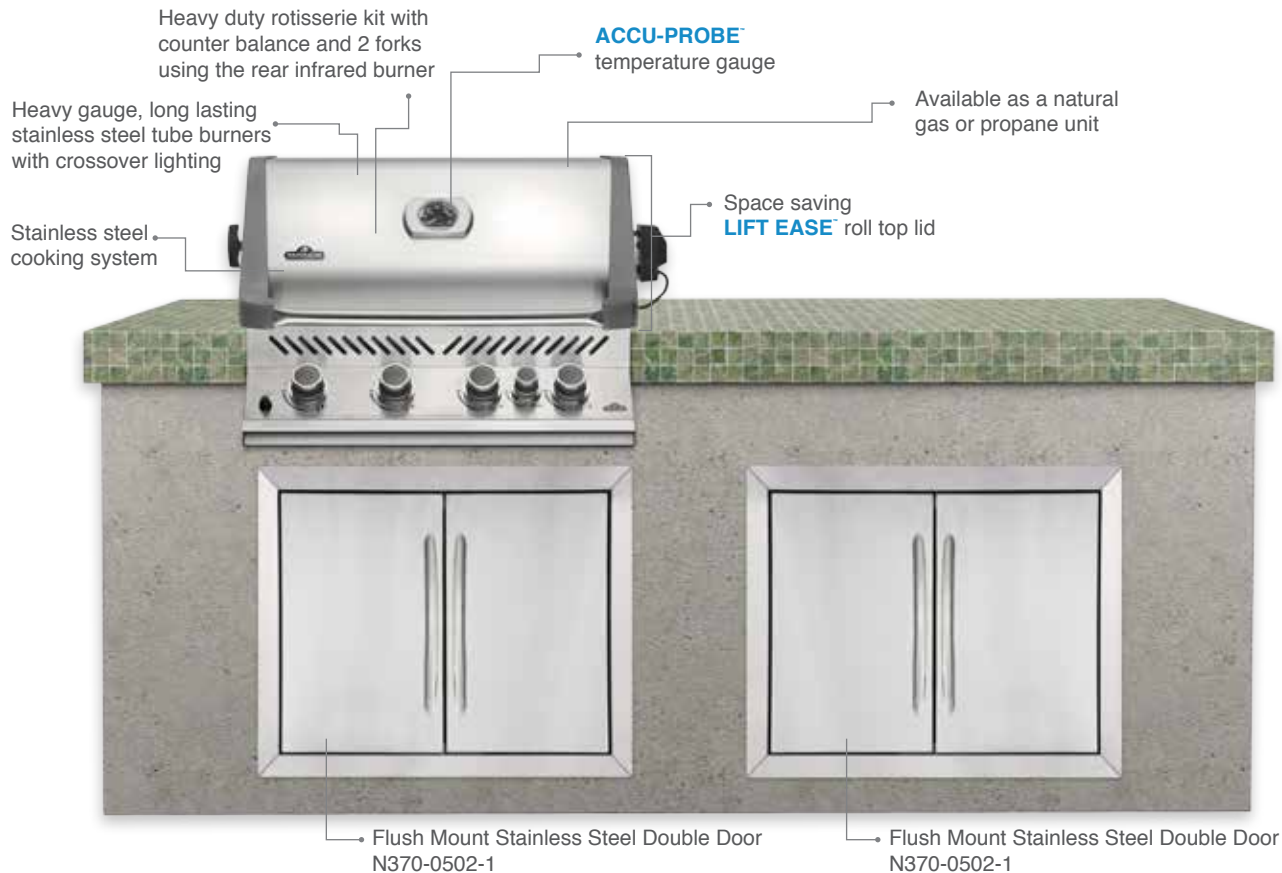

Doors and drawers are optional. Island not included.



7.5mm Stainless Steel WAVE™ Cooking Grids



Dual-Level, Stainless Steel Sear Plates



JETFIRE™ Ignition



Rear Infrared Rotisserie Burner



Proudly Made in Canada

DUAL-LEVEL STAINLESS STEEL SEAR PLATES

Dual-Level, individual stainless steel sear plates allow consistent, even heat and continuous grease run off. (Standard on BIPRO825RBI, BIPRO665RB, BIPRO500RB & BIP500RB)



LEX SERIES

BILEX730RBI, BILEX605RBI with rear infrared burner and infrared **SIZZLE ZONE™** bottom burner

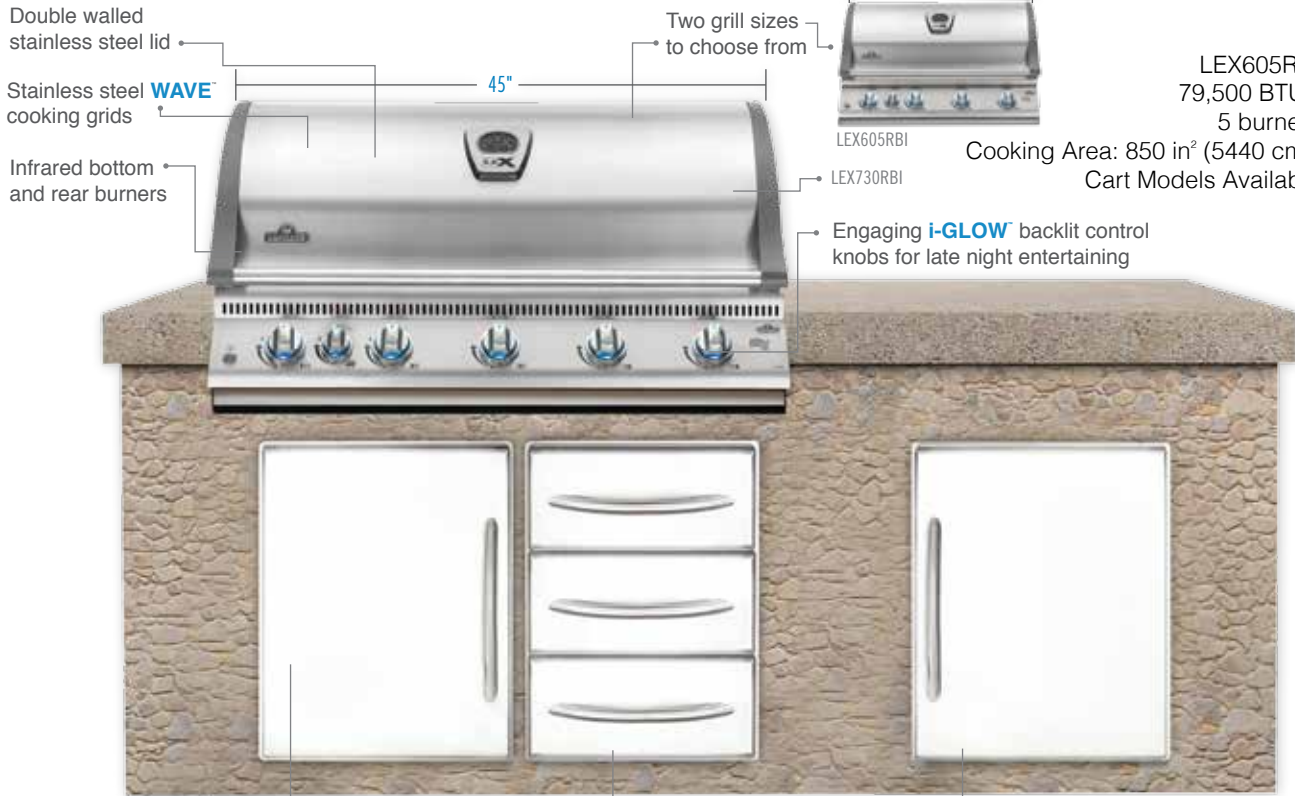

Double walled stainless steel lid
Stainless steel **WAVE™** cooking grids
Infrared bottom and rear burners

Two grill sizes to choose from



LEX605RBI
LEX730RBI

LEX730RBI
95,500 BTU's
6 burners
Cooking Area: 1025 in² (6530 cm²)
Cart Models Available

LEX605RBI
79,500 BTU's
5 burners
Cooking Area: 850 in² (5440 cm²)
Cart Models Available

Engaging **i-GLOW™** backlit control knobs for late night entertaining

Flat Stainless Steel Door Kit N370-0361-1
Flat Stainless Steel Triple Drawer Kit N370-0360
Flat Stainless Steel Door Kit N370-0361-1

Doors and drawers are optional. Island not included.



JETFIRE™ Ignition



i-GLOW™ Backlit Control Knobs



Ceramic Infrared Rear Burner



Infrared **SIZZLE ZONE™** Bottom Burner



CEDAR PLANKED BRIE CHEESE WITH FRESH BERRIES

Napoleon Cedar Plank soaked in water for one hour minimum	1		1
Brie Cheese	2 x 4½ oz		125 g
Strawberries trimmed and sliced into quarters	1 cup		250 mL
Fresh Berries blueberries, raspberries, or blackberries	1 cup		250 mL
Raspberry Jam	½ cup		125 mL
Sauvignon Blanc	¼ cup		60 mL
Black Pepper coarsely ground			to taste

CERAMIC REAR INFRARED ROTISSERIE BURNER

Ceramic rear rotisserie burner heat waves seal and lock in the juices quickly for superior tenderness. Restaurant style results and perfect self-basting roasts every time. (Heavy duty rotisserie kit with counter balance, stainless steel rotisserie bracket and forks available for most models).



SERVES:

PREP TIME: 1 HOUR

GRILLING TIME: 10 TO 12 MINUTES

1. Soak your cedar plank for a minimum of 1 hour in cold water.
2. Place the Brie wheels spaced evenly on the presoaked plank. Place all berries into a mixing bowl, pour in white wine and jam and toss gently to combine. Season with coarsely ground black pepper to taste.
3. Preheat grill to medium heat.
4. Spoon the berry mixture evenly over the top of the two wheels of cheese.
5. Place the plank onto the preheated grill and close the lid. Plank bake Brie for 10 to 12 minutes, or until sides are bulging and golden brown.

Remove plank from grill and serve with slices of fresh baguette or crackers and plenty of napkins.

LEX SERIES

CLASSIC BILEX485 with 4 burners

48,000 BTU's
4 burners
Cooking Area: 675 in² (4350 cm²)
Cart Models Available

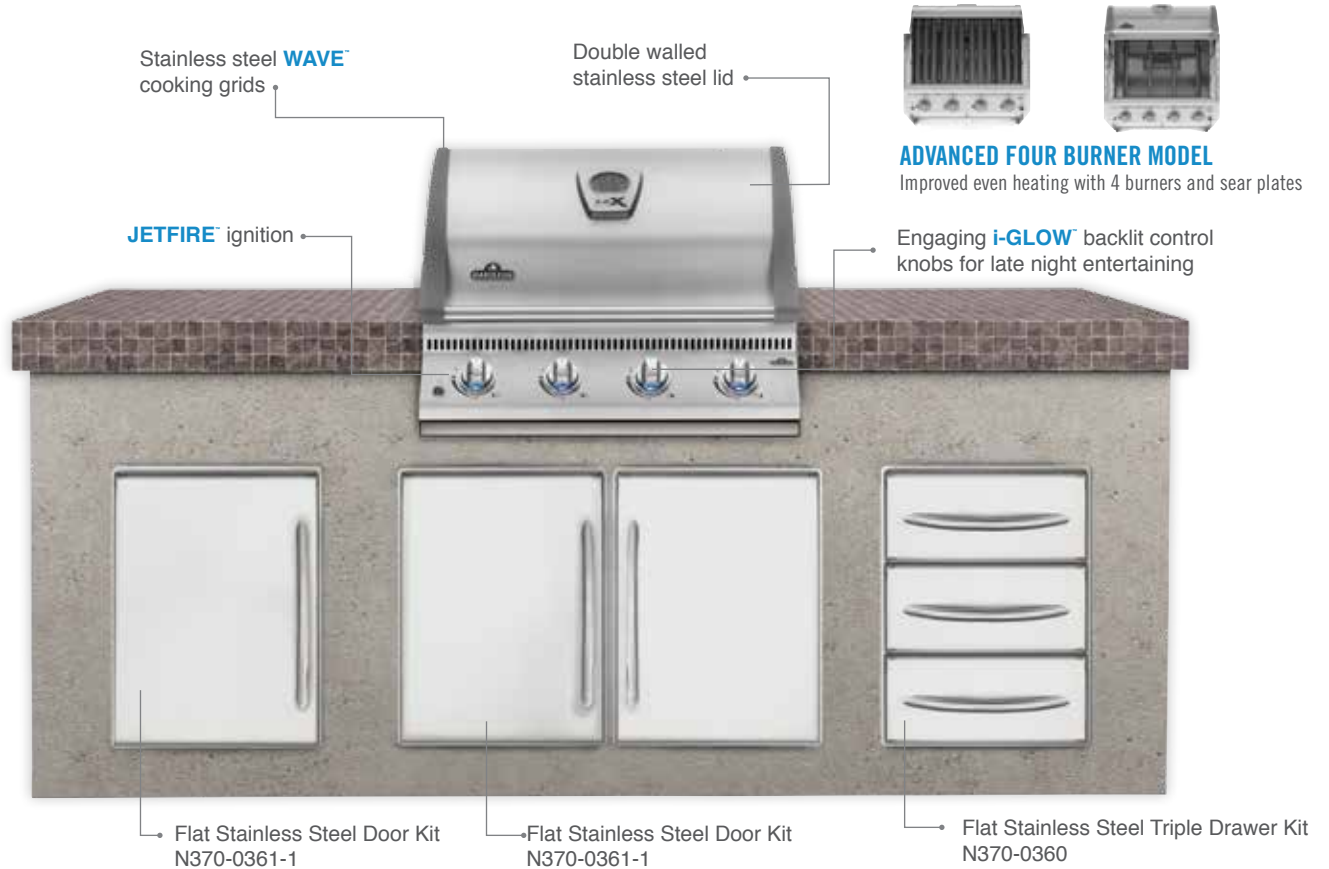

Doors and drawers are optional. Island not included.

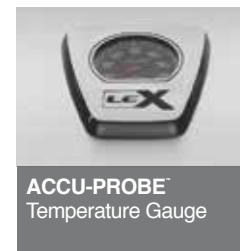
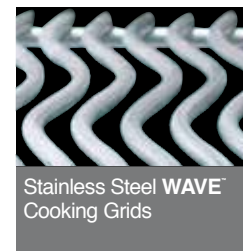
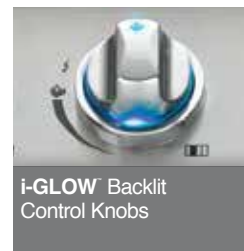

ACCU-PROBE™ TEMPERATURE GAUGE

Safely and instantly read the internal temperature of your grill with the lid closed. This thermometer has a wide temperature measurement range from 0° to 370°C (0° to 700°F) and includes the ideal smoking and searing range.



OASIS™ MODULAR ISLANDS

ENDLESS CONFIGURATION POSSIBILITIES

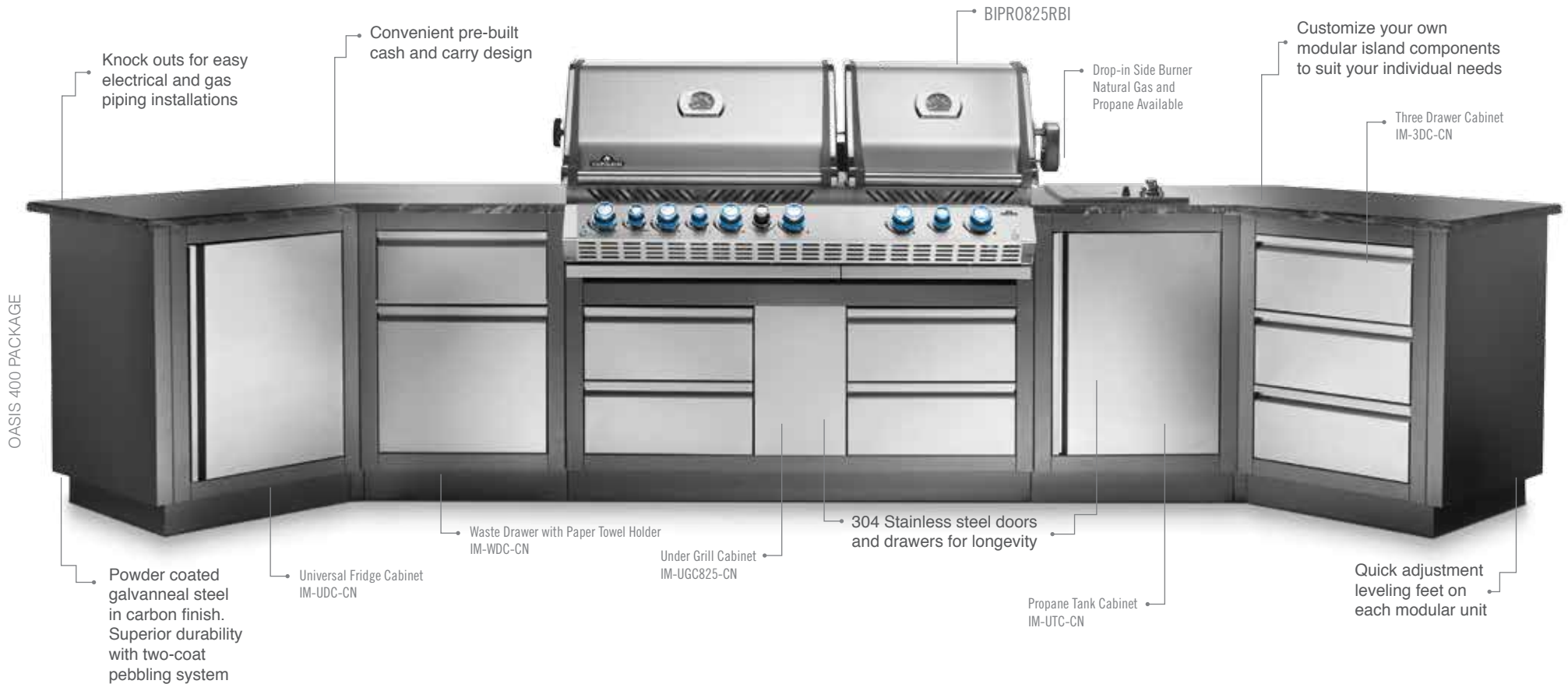

LATE NIGHT ENTERTAINING

Being the biggest fans of BBQ, Napoleon feels you should always be able to enjoy your favorite grilled meal and we have developed technology that makes every meal better and more easily prepared. You can entertain into the late hours with features such as interior lights and **i-GLOW™** and **NIGHT LIGHT™** control knobs that illuminate for easy grilling and food preparation. Wishing you many unforgettable meals – grilled to perfection.

The Napoleon Oasis™
Modular Island series
has been developed with
versatility in mind.



PERSONALIZE YOUR OUTDOOR LIVING SPACE WITH THE LUXURIOUS OASIS™ MODULAR ISLANDS

Choose the modules that fit your lifestyle and your budget. The cabinets can be assembled in virtually any combination to suit your individual needs. All cabinets are 35 1/2" tall and 24" deep with 4 leveling feet for easy adjustment on any surface. The **Oasis™** Outdoor Modular island series can be assembled against any non-combustible wall of your home or as a standalone island.

OASIS™ MODULAR ISLAND COMPONENTS



UNDER GRILL CABINETS

IM-UGC485-CN, IM-UGC500-CN,
IM-UGC605-CN IM-UGC665-CN,
IM-UGC730-CN



UNDER GRILL CABINET

IM-UGC300-CN
Fits side burners BISZ300, BISZ300FT,
BISB245



UNDER GRILL CABINET

IM-UGC825-CN



THREE DRAWER CABINET

IM-3DC-CN



TWO DRAWER CABINET

IM-2DC-CN



WASTE DRAWER WITH PAPER TOWEL HOLDER

IM-WDC-CN



PROPANE TANK OR UNIVERSAL CABINETS

IM-UTC-CN (Shown), IM-UDC-CN
Left or right opening



OUTDOOR RATED STAINLESS STEEL FRIDGE

NFR0550RSS



WALL SPACER

IM-WSF-CN



CABINET TRANSITIONS

IM-45T-CN = 45°
*BIPRO665 and BIPRO825 cannot
be installed on a 45° transition*



CABINET END PANEL

IM-CEP-CN
IM-FMP-CN
IM-FEP-CN

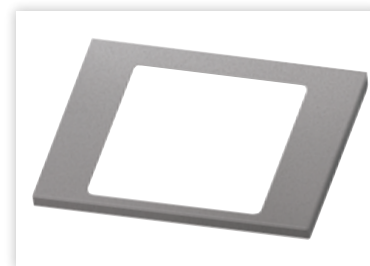

ICE BUCKET HOLDER

IM-IBA-CN



FINDING THE PERFECT STEAK

When buying a large steak, choose one that has a uniform thickness of about 1½". Buy a top quality cut that is well marbled to ensure tenderness. The better the quality of beef, the tastier your steak will be. For a quick sauce, jazz up store-bought BBQ sauce by adding chopped chilies, a little Worcestershire sauce, a splash of vinegar, some chopped fresh onions or garlic, or get creative.



BUILT-IN ISLAND DOORS, DRAWERS & BURNERS



DELUXE FLAT STAINLESS STEEL DOOR KIT WITH CURVED STAINLESS STEEL HANDLE
N370-0361-1



FLUSH MOUNT STAINLESS STEEL DOUBLE DOORS
N370-0502, N370-0503-1



DROP-IN SIDE BURNER
N370-0504-1 (LP), N370-0505 (NG)



DELUXE STAINLESS STEEL TRIPLE DRAWERS WITH CURVED STAINLESS STEEL HANDLES
N370-0360



DELUXE STAINLESS STEEL SINGLE DRAWER WITH CURVED STAINLESS STEEL HANDLE
N370-0359



DOUBLE SIDE BURNER
BISB245FT



INFRARED SIZZLE ZONE™ SIDE BURNER
BISZ300 with LIFT EASE™ Roll Top Lid



INFRARED SIZZLE ZONE™ SIDE BURNER
BISZ300FT with Stainless Steel Flat Cover

INSTANT JETFIRE™ IGNITION

Napoleon's **JETFIRE™** ignition starts each burner individually for reliable start ups - EVERY time.



EVERYDAY GRILLING ACCESSORIES



Meat Lovers Starter Kit
90001



Pizza Lovers Starter Kit
90002



Healthy Choice Starter Kit
90003



Meat Tenderizer
55204



3-in-1 Roasting Rack
56019



Professional Five Piece Toolset
70031



8 Stainless Steel Skewers
70015



Rotisserie Kits



Stainless Steel Grilling Wok
56026



Chicken Roaster & Wok
56024



Flexible Grill Basket
57012



Cast Iron Charcoal/Smoker Tray
67731

HERBS & SPICES

Dried herbs and spices make wonderful aromatics for grilling. Soak them for about 5 minutes, squeeze out the moisture, and sprinkle them either directly on the coals, or even in the water pan if you're cooking over indirect heat. Watch out for seeds, such as mustard and coriander. Heat makes them pop.





10" Baking Stone Set
70000



Rectangular Baking Stone
70008



Rotisserie Shish Kebab Wheel
64007



Wood Chip Starter Kit
67020



Stainless Steel Rotating Skewer Rack
70014



Super WAVE Grill Brush
62013

THE MOST VERSATILE COOKING STYLES AVAILABLE

Direct Cooking This method of cooking utilizes all burners, cooking the food directly above the flame "GRILLING" style, for searing steaks, other meats or vegetables. Keeping the lid down reduces the cooking time and cooks through to the center faster than with the lid up. Anything that is less than two inches in thickness should be cooked by direct grilling. These are things that generally cook quickly and benefit from the fast cooking of a hot grill. Front to back burners were designed for precise heat control, allowing for independent use of each cooking zone.

Indirect Cooking Indirect grilling is similar to baking. The food is placed above the unlit burner instead of directly over the flame. This can be achieved by only igniting some of the burners – light one side on high and cook the food on the other. The food will cook more evenly as it is not exposed to direct heat from the burners. This is an excellent way to cook tough cuts of meat, like brisket and ribs, that require long, slow cooking at a low or moderate heat. Indirect grilling allows you to work over a more moderate temperature (275° to 350°) and makes it easy to introduce a smoker pipe for extra flavor. For chicken, game, turkey, roasts, ham, vegetables, bread or combinations, the indirect cooking method gives great results every time. There is little need to turn the food. You can place the food directly on the grids or in a cooking pan.

Charcoal Cooking Unique to Napoleon! Optional charcoal trays give you the freedom to switch from gas to charcoal with relative ease. With charcoal you can utilize indirect cooking as well as direct cooking.

Rotisserie Cooking Rotisserie cooking allows the food to self-baste, sealing in the juices while browning the outside surface. Use the rotisserie method of cooking for large cuts of meat like roasts, poultry or legs of lamb. There are so many advantages to rotisserie cooking. Meats are generally juicier, self-basted and slow roasted. You can use the rotisserie method if your grill comes with a rear rotisserie burner, which requires much less attention than any other cooking method. The rotisserie burner is a nice feature because it automatically sets you up for direct, even heating.

Infrared Bottom Burner Cooking Do you want to make the perfect steak? The intense 1800° heat instantly sears the meat, locking in the juices. Larger cuts of meat may be moved to the side of the grill to continue cooking.

Smoking Place wet wood chips into the smoker tube and place over the left burner, then turn the burner on. Place your meat over the right burner, but do not turn on that burner. You are using the indirect cooking method. Smoke the meat for several hours under a closed lid. To achieve maximum flavor, fresh wood chips may be added several times during the cooking process.



Visit napoleongrills.com to see Napoleon's complete line of grilling accessories.

TROUBLE-FREE GRILLING

If you take the time to give your grill a thorough check-up in the spring and once more in the fall, you will enjoy years of trouble-free grilling. If you can't fit both check-ups in, choose the springtime, just before the busy summer grilling season starts, to get at least one good check-up.

COOKING WITH CHARCOAL ON YOUR GAS GRILL

A Napoleon Exclusive! Still want the convenience of gas, but long for that charcoal flavor? No problem! Napoleon's charcoal tray lights easily with your gas burner. No need for lighter fluid!

The optional charcoal tray gives you the freedom to switch from gas to charcoal with relative ease. Simply replace your sear plates with the charcoal tray, fill with charcoal and light using your gas burners. Replace your cooking grids and now you're charcoal grilling!

Before you begin to use your charcoal tray, you will need to determine how much charcoal you are going to need. Approximately one layer for burgers or steaks and two layers for roasts or chicken. Pour enough charcoal into the tray to make the layers needed. Light the gas burner(s) directly under the charcoal tray and burn on high until the charcoal is glowing red and then turn off the gas burner(s). Let coals burn until all coals are white on the surface. With a long handle instrument, spread the coals evenly across the tray.



WANT THAT SMOKED GOODNESS?

Enjoy that delicious smoked meat flavor at home with your own grill and a few pointers from Napoleon. When using gas grills, it's best to put presoaked wood chips in our smoker tube, available at Napoleon grill retailers. This keeps your grill from filling up with ashes and clogging the jets. If you are using a charcoal tray, then you can either put the wood directly on the preheated coals or place them in the wood chip chamber in the tray.

Fill the stainless steel smoker tube with wood chips. Submerge in water for at least half an hour. Place the smoker tube over the left burner and turn it on. Place your meat over the right burner, but do not turn on the burner. You are using the indirect smoking cooking method.

Smoke the meat for several hours under a closed lid. To achieve maximum flavor, add fresh, pre-soaked wood chips several times during the cooking process or use two tubes.

OVEN-LIKE PERFORMANCE

Your gas grill can also be used as a conventional or convection oven. Bread, buns, cakes and pizzas can be cooked to perfection under the grill lid. For convection cooking, follow the same instructions as for the indirect cooking method. Your grill comes with a tightly sealed lid for heat retention, giving oven-like performance.

HOW DOES INFRARED COOKING WORK?

Since the discovery of fire, man-kind has been striving to improve taste and perfect the grilling experience. Infrared grilling is simply the relationship between the type of food, heat, and time. Infrared cooking uses high-efficiency radiant energy, much like the sun. High-frequency electromagnetic waves from the invisible end of the light spectrum travel from the infrared source to the food. Napoleon infrared grills use ceramic burners with thousands of evenly spaced flame ports to generate infrared radiant energy. The flame energy is absorbed by the ceramic, which then glows and heats up to an incredible 1800°F. This remarkable **SIZZLE ZONE™** heat intensity quickly sears your food to lock in moisture and flavor. The results are unmistakable - succulent, flavorful food in a much-reduced grilling time! Napoleon's infrared grilling technology makes serving the perfect meal quick and easy each and every time.

Versatile

Grill anything like a professional, from steaks to seafood, fish to vegetables.

Great Retention of Flavor and Moisture

Infrared provides the heat necessary to lock in the juices with little or no preheating time. Radiant energy is delivered more directly to the food, and warms less air. Therefore, the food cooks very quickly, resulting in a greater retention of food weight. Food cooked in its own juices is more succulent, tender and tasty.

More Efficient

Infrared heats the object not the air so it cooks twice as fast as traditional burners while using less fuel. Because infrared heats food directly, not the air around it, grilling year round is much easier.

“DONENESS” TEST

Take your left forefinger and touch it to the tip of your left thumb. Don't apply pressure, just use the lightest touch with your finger, touching the base of the meaty part of your thumb. This feeling is similar to the consistency of rare steak. Now compare it by touching the steak. For medium done, use the second finger of your left hand to touch the tip of your left thumb. Well done, use the third finger of the left hand.

The Environmental Choice!

Because the infrared burners are ready to grill in under a minute and grilling time is drastically decreased, cooking your food with Napoleon's advanced infrared technology can reduce your gas consumption by up to 50%.

BTU Consumption

Traditional Grilling

Napoleon Infrared Grilling

How To Cook The Perfect Infrared Steak

Pick a steak that is well marbled, the more marble there is inside, the more flavorful and tender your steak will be. A perfect steak size is about 1 ½ to 2 inches thick and about 12 to 16 ounces each, depending on the cut.

1. Lift lid of grill or side burner.
2. Ignite infrared burner.
3. Warm up for one minute.
4. Place thick, juicy steak on grids.
5. Wait two - three minutes, flip steak with tongs. (You do not want to use a fork and pierce the steak as this will let out the juices the infrared has locked in).
6. Wait another two – three minutes, turn off the knob.
7. You now have a medium rare steak.

Bon Appetite.

NAPOLEON
EXPERTS IN
GAS & INFRARED
GRILLING

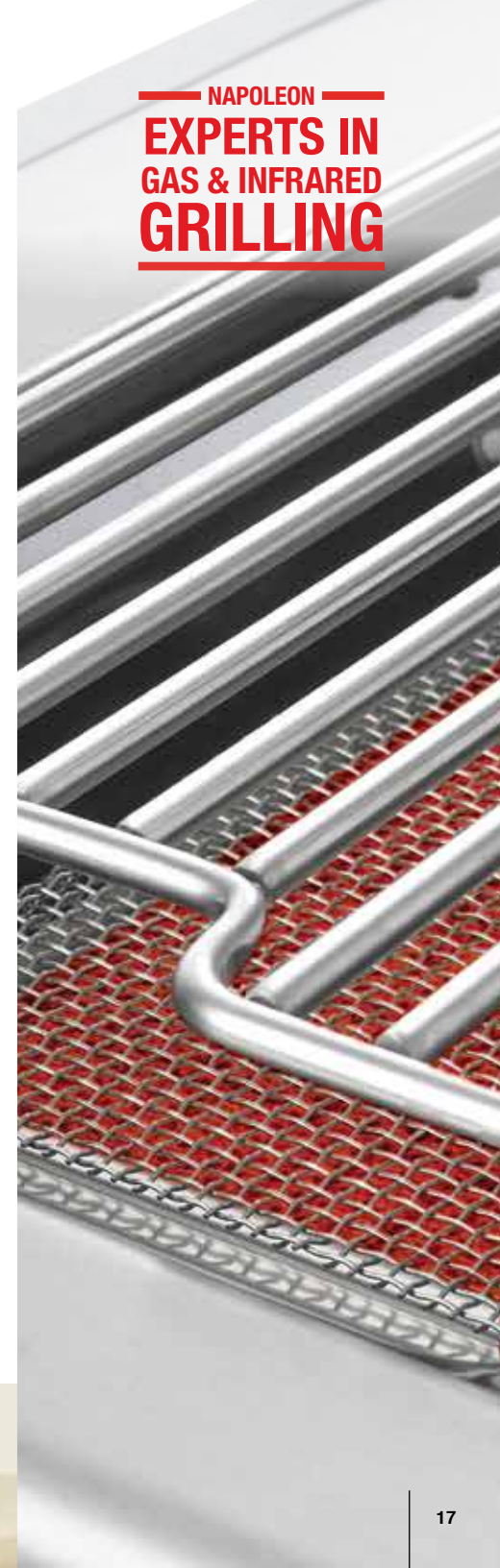

BUILT-IN GRILL HEADS AVAILABLE FOR YOUR CUSTOM OASIS™ ISLAND / BUILT-IN ISLAND

Remember to always refer to the owner's manual for complete and accurate installation instructions.



BIPR0500RB

Opening dimensions:
30 3/4" w x 20 5/8" d x 8 7/8" h
(78 cm w x 52 cm d x 23 cm h)



BIPR0665RB

Opening dimensions:
38" w x 20 5/8" d x 8 7/8" h
(97 cm w x 52 cm d x 23 cm h)



BIPR0825RBI

Opening dimensions:
52 3/8" w x 20 5/8" d x 8 7/8" h
(133 cm w x 52 cm d x 23 cm h)



BIP500RB

Opening dimensions:
30 3/4" w x 20 5/8" d x 8 7/8" h
(78 cm w x 52 cm d x 23 cm h)



BILEX485

Opening dimensions:
29 3/4" w x 21 3/8" d x 7 1/2" h
(76 cm w x 54 cm d x 19 cm h)



BILEX605RBI

Opening dimensions:
36 1/2" w x 21 3/8" d x 7 1/2" h
(93 cm w x 54 cm d x 19 cm h)



BILEX730RBI

Opening dimensions:
43 1/4" w x 21 3/8" d x 7 1/2" h
(110 cm w x 54 cm d x 19 cm h)

ALL SEASON GRILLING

The secret to grilling success in any season, is preparation. Always locate your grill away from the wind in a well-ventilated location to ensure consistent heat. Don't let the heat escape by constantly lifting the lid to check; instead use your thermometer. And, don't be afraid to use the warming rack to keep food warm or to finish cooking, if the rest of your food continues to cook on the main burners.

INSTALLATION SPECIFICATIONS

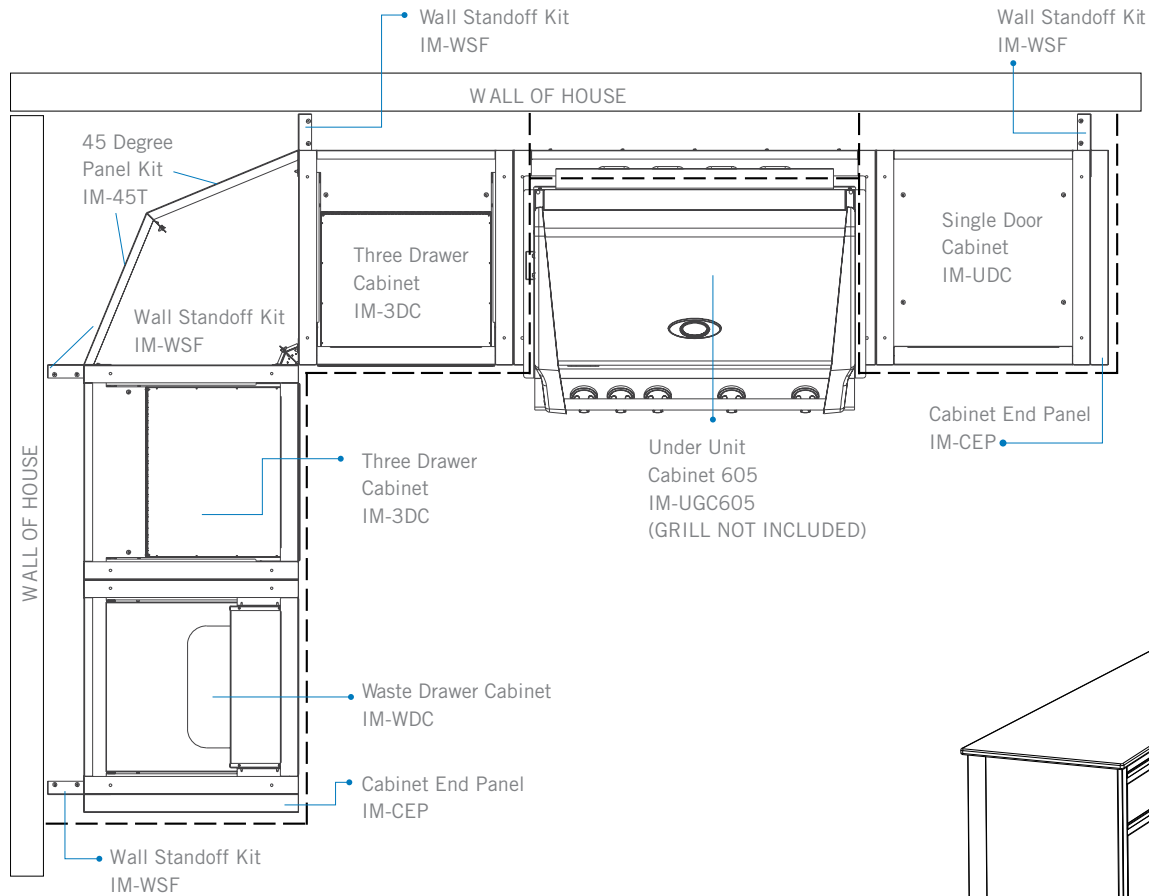

When being built into **OASIS** cabinets, the **BIPRO665** and **BIPRO825** units cannot be used directly adjacent to the 45° transition kit (Im-45t). Remember to always refer to the owner's manual for complete and accurate installation instructions.

OASIS™ MODULAR ISLAND SAMPLE

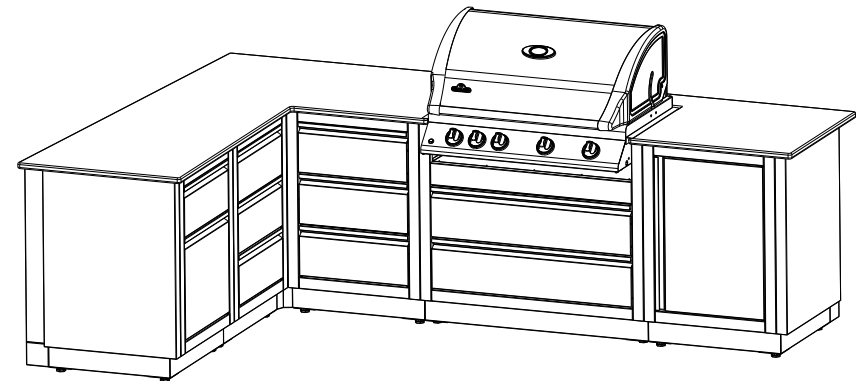

The countertop material must be non-combustible if a grill is to be installed into it. They can be ordered in advance by drawing out the floor plan of how the cabinets will be situated and adding up the width measurements, allowing 1-2" of countertop overhang. Most countertop manufacturers are willing to come and take measurements after assembly of the cabinets is complete to ensure a perfect fit. For best results the countertop thickness should be between ¾" to 1 ½" thick. The built-in grill head comes with stainless steel brackets and hardware that allow the unit to rest on the countertop above the corresponding island cabinet for that unit. Granite is an excellent choice of countertop materials. Decorative countertops made of ceramic tile set on top of cement tiling board can be selected to match your surrounding backyard furniture color.

* Countertops must be ordered and supplied locally by the homeowner.

BUILT-IN NATURAL GAS HOOK-UP

The piping up to the gas grill is the responsibility of the installer and piping should be located as shown in the built-in instructions. Do not use hose to connect the unit. It must be connected with rigid pipe, copper tube or an approved flexible metal connector which complies with Z21.4 /CSA 6.10. The installation must comply with CAN B149.1 Natural Gas and Propane Installation Code in Canada, or to the National Fuel Gas Code, ANSI Z223.1 in the United States. The gas supply pipe must be sufficiently sized to supply the BTU/h specified on the rating plate, based on the length of the piping run. If installing a side burner, a separate line must be branched off to the side burner unit and enter the side burner opening at the specified location.

INSTALLATION SPECIFICATIONS

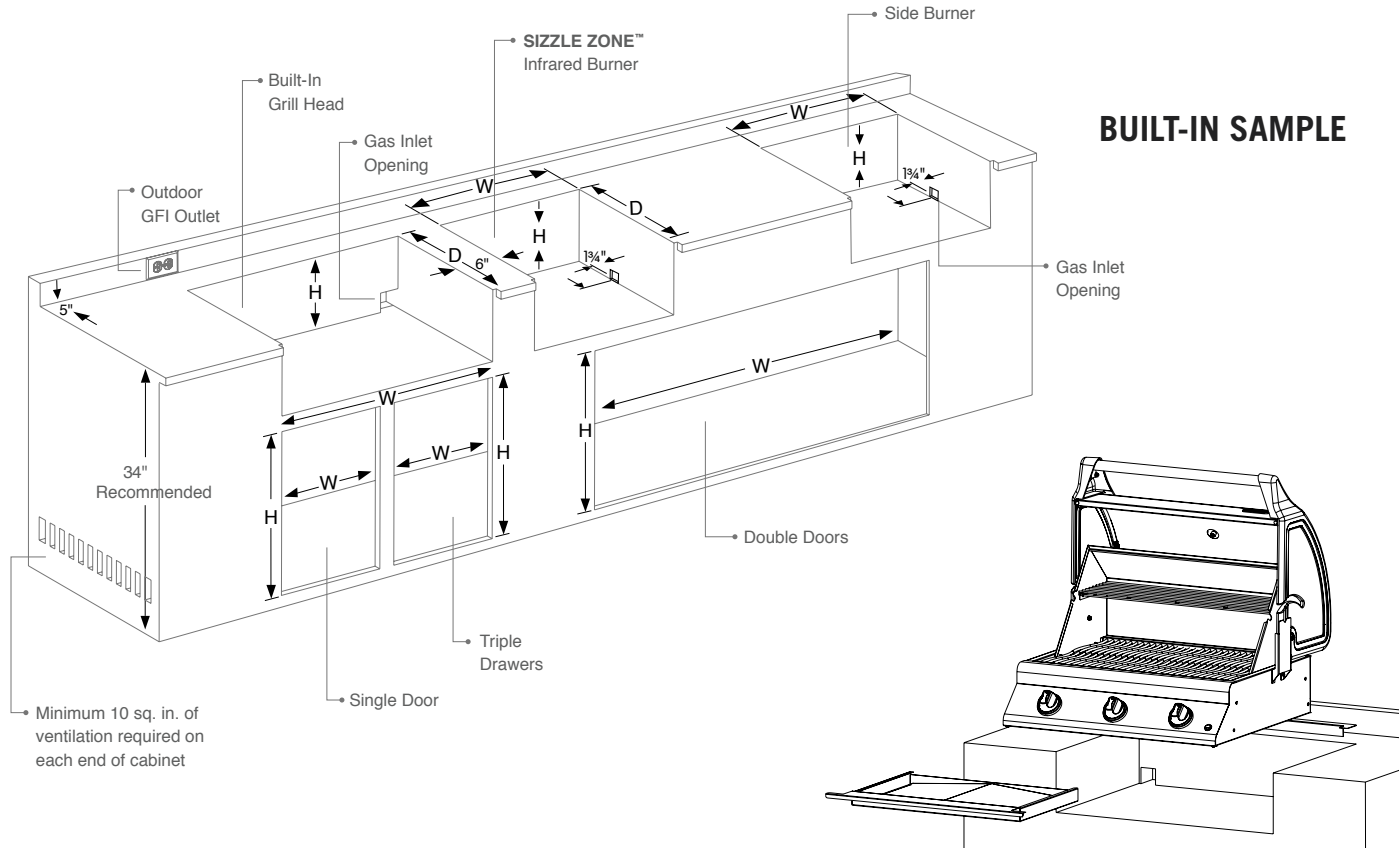

BUILT-IN SAMPLE



Please use manual to properly assemble your built-in grill. Refer to the main manual for operating, cleaning, and maintenance instructions. This grill is designed for non-combustible enclosures only, and must be installed and serviced by a qualified installer to local codes.

Drawings for reference only. Minimum 6" clearance required between grill and other appliance. Specifications subject to change without notice.

* Additional clearance may be required for openings. See owners manual

BUILT-IN PROPANE GAS HOOK-UP

The piping up to the gas grill is the responsibility of the installer and piping should be located as shown in the built-in instructions. The installation must comply with CAN B149.1 Natural Gas and Propane installation code in Canada, or to the National Fuel Gas code, ANSI Z223.1 in the United States. The tank can not be stored below the gas grill. Built-in units are supplied with a drip pan which holds only a minimal amount of grease. To prevent grease fires, the pan must be cleaned after each use.



GRILL SPECIFICATIONS	BIPR0825RBI	BIPR0665RB	BIPR0500RB	BIP500RB	BILEX730RBI	BILEX605RBI	BILEX485
LIFT EASE™ roll top stainless steel lid	S	S	S	S	-	-	-
Double walled stainless steel lid	S	S	S	S	S	S	S
ACCU-PROBE™ temperature gauge	S	S	S	S	S	S	S
Total cooking surface (sq. in.)*	1245	1000	760	760	1025	850	675
Electronic ignition	S°	S°	S°	S°	-	-	-
JETFIRE™ ignition	S	S	S	S	S	S	S
Infrared ceramic bottom burners	2	0	0	0	1	1	-
Stainless steel bottom burners	4	5	4	4	4	3	4
Infrared rear rotisserie burner	S	S	S	S	S	S	-
Integrated wood chip smoker tray	S	S	-	-	-	-	-
Stainless steel WAVE™ cooking grids	-	-	-	S	S	S	S
Stainless steel 9.5 mm WAVE™ cooking grids	S	S	S	-	-	-	-
i-GLOW™ / NIGHT LIGHT™ control knobs	S	S	S	-	S	S	S
SAFETY GLOW	S	S	-	-	-	-	-
Interior lights	S	S	-	-	-	-	-
EASY SET™ control knobs	S	S	S	S	S	S	S
Removable drip pan	S	S	S	S	S	S	S
Warming rack	S	S	S	S	S	S	S
President's Limited Lifetime Warranty	S	S	S	S	S	S	S

DIMENSIONS (opening size for installation)	BIPR0825RBI	BIPR0665RB	BIPR0500RB	BIP500RB	BILEX730RBI	BILEX605RBI	BILEX485
Total width in inches (cm)	52 ¾ (133)	38 (97)	30 ¾ (78)	30 ¾ (78)	43 ¼ (110)	36 ½ (93)	29 ¾ (76)
Total depth in inches (cm)	20 ¾ (52)	20 ¾ (52)	20 ¾ (52)	20 ¾ (52)	21 ¾ (54)	21 ¾ (54)	21 ¾ (54)
Total height in inches (cm)	8 ¾ (23)	8 ¾ (23)	8 ¾ (23)	8 ¾ (23)	7 ½ (19)	7 ½ (19)	7 ½ (19)

DOORS & ACCESSORIES (opening size for installation)	Part Number	Width in. (cm)	Depth in. (cm)	Height in. (cm)	OASIS™ MODULAR COMPONENTS	Part Number	Width in. (cm)	Depth in. (cm)	Height in. (cm)
Flat Stainless Steel Door	N370-0361-1	17 (43)	-	23 ¼ (59)	Under Grill Cabinet - 825 series	IM-UGC825-CN	55 (139)	24 (61)	35 ½ (90)
Flushed Mount Stainless Steel Double Door	N370-0502-1	28 ¼ (72)	-	20 ¼ (51)	Under Grill Cabinet - 665 series	IM-UGC665-CN	40 ½ (103)	24 (61)	35 ½ (90)
Flushed Mount Stainless Steel Double Door	N370-0503-1	37 ¾ (96)	-	20 ¼ (51)	Under Grill Cabinet - 500 series	IM-UGC500-CN	34 ¾ (88)	24 (61)	35 ½ (90)
Stainless Steel Single Drawer	N370-0359	17 ¼ (44)	23 (58)	6 ¾ (17)	Under Grill Cabinet - 730 series	IM-UGC730-CN	47 ¼ (120)	24 (61)	35 ½ (90)
Stainless Steel Triple Drawer	N370-0360	17 ¼ (44)	23 (58)	22 ¾ (58)	Under Grill Cabinet - 605 series	IM-UGC605-CN	40 ½ (103)	24 (61)	35 ½ (90)
Infrared SIZZLE ZONE™ Burner with Roll Top	BISZ300	20 ¾ (51)	20 ¾ (52)	9 ¾ (23)	Under Grill Cabinet - 485 series	IM-UGC485-CN	34 ¾ (88)	24 (61)	35 ½ (90)
Infrared SIZZLE ZONE™ with Flat Top	BISZ300FT	20 ¾ (51)	20 ¾ (52)	9 ¾ (23)	Under Grill Cabinet - 300 series	IM-UGC300-CN	24 (61)	24 (61)	35 ½ (90)
Double Side Burner	BISB245	20 ¾ (51)	20 ¾ (52)	8 ¾ (23)	Propane Tank Cabinet - universal door	IM-UTC-CN	24 (61)	24 (61)	35 ½ (90)
Side Burner	N370-0504/05	12 ¾ (32)	16 ½ (42)	4 ½ (11)	Universal Door Cabinet	IM-UDC-CN	24 (61)	24 (61)	35 ½ (90)
					Outdoor Rated Fridge	NFR055ORSS	24 (61)	26 (66)	34 (86)
					Three Drawer Cabinet	IM-3DC-CN	24 (61)	24 (61)	35 ½ (90)
					Two Drawer Cabinet	IM-2DC-CN	24 (61)	24 (61)	35 ½ (90)
					Waste Drawer with Paper Towel Holder	IM-WDC-CN	24 (61)	24 (61)	35 ½ (90)
					Wall Spacer	IM-WSF-CN	1 ½ (4)	4 (10)	35 (89)
					Ice Bucket Holder	IM-IBA	19 ¼ (49)	16 (41)	1 ½ (4)

Important: Always refer to manual for individual models. Dimensions shown here are rounded for approximation - Dimensions subject to change. Refer to manual for accurate dimensions. Refer to manual for end panels and transition kits not shown here.



NAPOLEON - CELEBRATING OVER 40 YEARS OF HOME COMFORT PRODUCTS



214 Bayview Drive, Barrie, Ontario, Canada L4N 4Y8
103 Miller Drive, Crittenden, Kentucky, USA 41030
7200 Trans Canada Highway, Montreal, Quebec H4T 1A3

PHONE: 705-726-4278 FAX: 705-725-2564
napoleongrills.com
info@napoleonproducts.com

Approved by Intertek Testing Services to standards in the USA and Canada: ANSI Z21.58 / CSA 1.6 - Outdoor Cooking Gas Appliances. All specifications and designs are subject to change without prior notice due to ongoing product improvements. Consult your owner's manual for complete installation and operating instructions and check all local and national Building Codes and Regulations. Not all features available on all models. Napoleon is a registered trademark of Wolf Steel Ltd. Images and colors may not be exactly as shown.

Authorized Dealer



Printed in Canada
ADBRBI 01/2017