



ENGLISH

ESPAÑOL

OWNER'S MANUAL AIR PURIFIER

Read this owner's manual thoroughly before operating the appliance and keep it handy for reference at all times.

Model name: AS401VSA0 / AS401VGA1



P/NO : MFL68181320

Copyright © 2016 - 2018 LG Electronics Inc. All Rights Reserved.

www.lg.com





2 TABLE OF CONTENTS

TABLE OF CONTENTS

3 PRODUCT FEATURES

4 SAFETY INSTRUCTIONS

8 PRODUCT OVERVIEW

- 8 Front
- 8 Back
- 9 Control Panel and Display
- 10 PuriCare Filtration System

11 INSTALLATION

- 11 Choosing the Proper Location
- 11 Tips for Using the Air Purifier
- 12 Initial Installation of Filter

13 OPERATION

- 13 Air Purification
- 14 Turbo Function
- 14 PM Indicator Display
- 14 Air Quality Indicator Light
- 16 Off Timer Function
- 17 Lock Function
- 18 Filter Life Light

19 MAINTENANCE

- 19 Cleaning the Filters
- 21 Filter Maintenance Schedule
- 21 Cleaning the Exterior
- 22 Cleaning the Sensor
- 23 Storing the Product

24 TROUBLESHOOTING

26 WARRANTY





PRODUCT FEATURES

SMART AIR QUALITY SYSTEM

The air quality display senses and shows indoor particulate levels in real time. It can sense fine particulate matter as small as 1.0 micron.

PURICARE FILTRATION SYSTEM

The combination of the washable pre-filter, PuriCare Main Filter, and deodorizing filter provide fresh indoor air by removing invisible air pollutants. Remove irritants ranging from pet hair and pollen to tobacco smoke odors and VOCs (volatile organic compounds).

LODECIBEL QUIET OPERATION

In the sleep mode, the air purifier runs at only 23 dB and can be scheduled to shut off automatically, making falling asleep easy.

PURICARE MAIN FILTER

The PuriCare Main Filter captures particles as small as 0.3 microns. This particulate matter can include pollen and dust.





4 SAFETY INSTRUCTIONS

SAFETY INSTRUCTIONS

READ AND SAVE THESE INSTRUCTIONS

Your safety and the safety of others are very important.

We have provided many important safety messages in this manual and on the appliance. Always read and follow all safety messages.



This is the safety alert symbol. This symbol alerts you to potential hazards that can kill or injure you or others. All safety messages will follow the safety alert symbol and either the word WARNING or CAUTION.

These words mean:



WARNING

If you do not follow instructions, it could result in death or serious injury.



CAUTION

If you do not follow instructions, it could result in minor or moderate injury or damage to the product.

All safety messages will tell you what the potential hazard is, tell you how to reduce the chance of injury, and tell you what may happen if the instructions are not followed.

IMPORTANT SAFETY INSTRUCTIONS



WARNING

To reduce the risk of explosion, fire, death, electric shock, scalding, or injury to persons when using this appliance, follow basic precautions, including the following:

Installation

- Do not modify or extend the power cord.
- Do not plug the product into an outlet which is loose or damaged.
- Never attempt to operate this appliance if it is damaged, malfunctioning, partially disassembled, or has missing or broken parts, including a damaged cord or plug.
- Do not use the product in locations where it will be exposed to high humidity, moisture, or oil splatter such as in the bathroom, laundry, or near the stove.
- Connect the product to a properly rated, protected, and sized power circuit to avoid electrical overload.
- In the event of a gas leak (propane gas, LP gas, etc.) do not operate this or any other appliance. Open a window or door to ventilate the area immediately.
- Do not store or use gasoline or other flammable vapors and liquids in the vicinity of this or any other appliance.
- If you detect a strange sound, a chemical or burning smell, or smoke coming from the product, unplug it immediately and contact an LG Electronics customer information center.

- Be careful not to allow the power cord to be pinched, crushed or damaged under heavy objects.
- Do not install the product in direct sunlight, near heat sources such as furnaces or ovens, near fireplaces or other open flames, or in wet or humid locations.
- Keep packing materials out of the reach of children. Packaging material can be dangerous for children. There is a risk of suffocation.
- Store and install the product where it will not be exposed to temperatures below freezing or exposed to outdoor weather conditions.

Operation

Read all instructions before using the product and save these instructions.

- Use this product only for its intended purpose.
- Do not tamper with controls.
- Do not allow children to play on or with the product. Close supervision of children is necessary when the product is used near children.
- Repair or immediately replace all power cords that have become damaged. Do not use a cord that shows cracks or abrasion damage along its length or at either end.
- Do not grasp the power cord or touch the appliance controls with wet hands.
- Do not modify or extend the power cord.
- If the product has been submerged, contact LG Electronics customer information center for instructions before resuming use.
- This appliance is not intended for use by persons (including children) with reduced physical, sensory or mental capabilities, or lack of experience and knowledge, unless they have been given supervision or instruction concerning the use of the appliance by a person responsible for their safety.
- If the electrical supply cord is damaged, it must only be replaced by the manufacturer or its service agent or a similar qualified person in order to avoid a hazard.
- Never unplug the appliance by pulling on the power cord. Always grip the plug firmly and pull straight out from the outlet.
- Do not place obstacles at the air suction port or discharge port of the product.
- Do not move the product while it is under operation.
- Do not put hands, glue or metal objects near the air suction port or discharge port of the product.
- Do not install the product in locations with excessive industrial oil smoke or metallic dust. Doing so may result in fire or product failure.
- Use only the handle to move the product.
- Do not repair or replace any part of the appliance. All repairs and servicing must be performed by qualified service personnel unless specifically recommended in this owner's manual. Use only authorized factory parts.
- Disconnect the appliance from the power supply before cleaning and attempting any user maintenance. Turning the controls to the OFF position does not disconnect the appliance from the power supply.



6 SAFETY INSTRUCTIONS

- Do not disassemble or repair the appliance by yourself.
- Avoid any impact to the front panel of the appliance.

California Safe Drinking Water and Toxic Enforcement Act

WARNING: This product contains chemicals known to the State of California to cause cancer and birth defects or other reproductive harm. *Wash hands after handling.*

CAUTION

To reduce the risk of injury to persons, malfunction, or damage to the product or property when using the appliance, follow basic safety precautions, including the following:

Installation

- Avoid installing within 3 1/4 ft (1 m) of any TV or audio equipment.
- Do not use this appliance as a substitute for a ventilation fan or hood for a range.
- Unplug the appliance and wait for the fan to stop rotating before servicing or cleaning. The fan rotates at a high speed and may cause injury.
- Do not use the product to remove toxic gas such as carbon monoxide.
- Install the product on a firm and level surface. Avoid dropping or impacts to the product.
- Provide clearance of at least 5 ft (1.5 m) from lighting appliances and at least 4 in. (10 cm) from walls. Failure to do so may result in product discoloration or loss of cleaning performance.
- Use only 115 V.
- This appliance is not designed for maritime use or for mobile installations such as in RVs, trailers, or aircraft.

Operation

- This product is not intended for use in preserving animals/plants, precision equipment, art pieces, etc. Use this appliance only for its intended purpose.
- Do not use solvents or strong detergents to clean the product. Doing so may result in fire and product deformation.
- Unplug the product if it will remain unused for a long time.
- Do not place objects on or step on the Air Purifier.
- Insert all filters (including the pre-filter) before operating, and clean the filter regularly following the schedule suggested in this owner's manual. Failure to do so may shorten the effective life of the filter.
- Remove the tie from the power cord before use.



- Allow the pre-filter to dry completely, out of direct sunlight, after washing. Do not operate appliance with a damp filter. Do not operate appliance without pre-filter.
- Do not insert inflammables inside the product.
- Do not place the appliance where it can come into contact with the moisture from a humidifier.
- Do not open the back panel while the product is in operation.





ENGLISH

8 PRODUCT OVERVIEW

PRODUCT OVERVIEW

Front

Air quality indicator light

Lights to indicate the overall indoor air quality as detected by the dust / gas sensor.

- Air Quality Levels
(contaminated) red → orange → yellow → green (clean)

* At start up, the air quality indicator light blinks white for 30 seconds. After the sensor stabilizes, the indicator displays the indoor air quality.

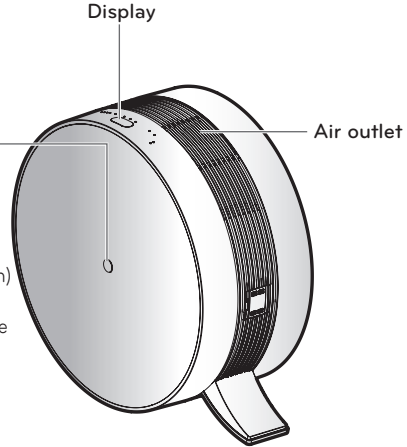

Back

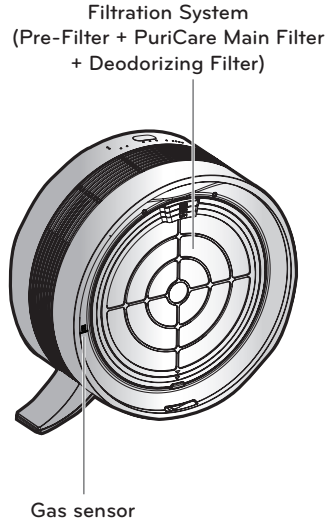
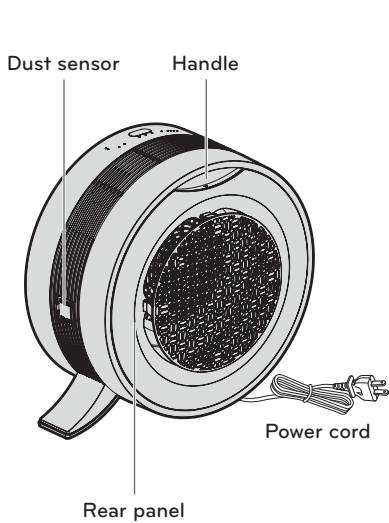

Control Panel and Display

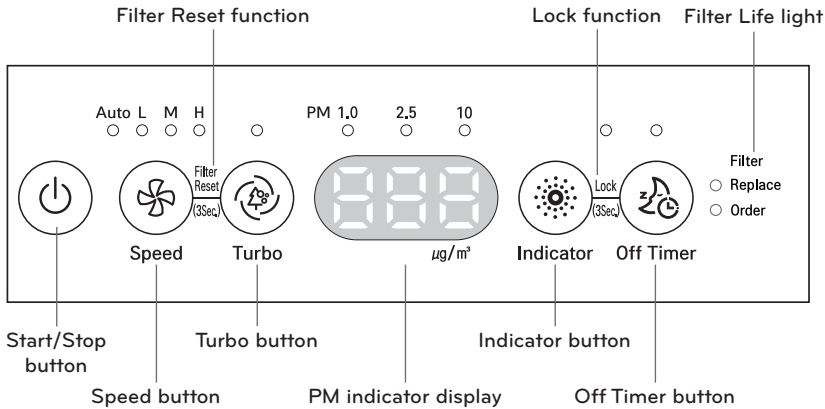

Start/Stop button	Starts and stops the product.
Speed button	Adjusts the speed and volume of the fan.
Turbo button	Cleans indoor air faster for 30 minutes.
Indicator button	Toggles between PM density results for different dust particle sizes.
Off Timer button	Sets the appliance to sleep mode and automatically turns it off after the selected amount of time.
Filter Reset function	Resets operating time after replacing the filter.
Lock function	Locks control panel so product won't be accidentally turned off or settings changed by children or others.
Filter Life light	Orange (Operating time: 3,600~4,000 hr) - Time to order a replacement filter. Red (Operating time: over 4,000 hr) - Replace the filter. * After replacing the filter, use the Filter Reset function to reset the operating time.
PM density display	Shows the density of dust for three different particle sizes.

* Guide to PM (Particulate Matter)

PM10: dust particle size is equal or below 10 μm

(Sources include nearby fires and dust stirred up by vehicles on roads.)

PM2.5: dust particle size is equal or below 2.5 μm

(Sources include exhaust from motor vehicles or power plants, wood burning fires, and some industrial processes.)

PM1.0: dust particle size is equal or below 1.0 μm (Sources include cigarette smoke and smog.)

10 PRODUCT OVERVIEW

PuriCare Filtration System

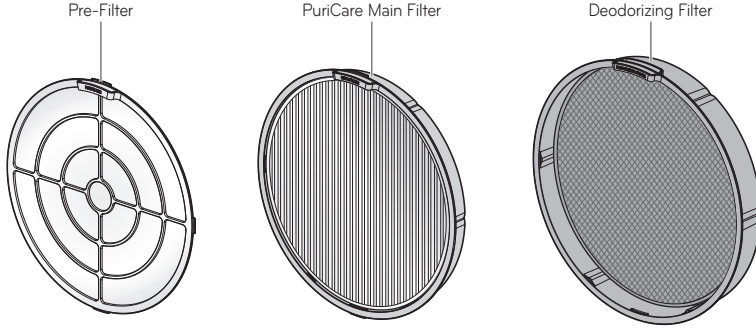

Filter name	Function
Pre-Filter	Filters out large particles to prolong the lifespan of the PuriCare Main Filter.
PuriCare Main Filter	Removes fine particles such as pollen, cigarette smoke (particulates), micro dust motes and animal fur.
Deodorizing Filter	Comprehensively removes odors from cigarette smoke, garbage, pets, strong acids or bases (vinegar, bleach).

※ The life-expectancy of the filters depends on the usage environment of the air purifier.
 ※ Do not discard the filter case. Replacement filters do not include a new case.

NOTE

- The effective life of the filters varies depending on the operational environment.
- The composition of filters can vary by model.
- Replacement filters can be purchased from a nearby LG service center or online through LG.com.
- Use only the filters designed and approved by the manufacturer for use with this product.

INSTALLATION

Choosing the Proper Location

- Place within reach of a power outlet.
- Make sure air inlet and outlet are free from obstacles.
- Place on a level, stable surface where air circulates freely.
- Elevate air purifier on a stable table for more efficient operation.

WARNING

This product is not designed for maritime use or for mobile installations such as in RVs, trailers, or aircraft. Failure to follow this warning can result in product failure.

WARNING

This appliance is not intended for use by persons (including children) with reduced physical, sensory or mental capabilities, or lack of experience and knowledge, unless they have been given supervision or instruction concerning use of the appliance by a person responsible for their safety.

Children should be supervised to ensure that they do not play with the appliance.

WARNING

This appliance has a polarized plug (one blade is wider than the other). To reduce the risk of electric shock, this plug is intended to fit in a polarized outlet only one way. If the plug does not fit fully in the outlet, reverse the plug. If it still does not fit, contact a qualified electrician. Do not attempt to defeat this safety feature.

Tips for Using the Air Purifier

- Avoid using the air purifier while cooking strong-smelling or fried foods such as fish.
 - The vaporized oil from the cooking may affect the performance and life-expectancy of the filters and the odors may cling to the filter.
- Do not place the air purifier closer than 3 1/4 ft (1 m) to the bed.
 - The fan speed in sleep mode is low, but it could cause an unwanted draft.
- Do not place the air purifier in a corner.
 - Avoid surrounding the appliance with furniture and electronic equipment or crowding it into a corner. The air purifier works best when air is free to circulate around it.



12 INSTALLATION

Initial Installation of Filter

Remove the packaging before installing the filter.

1. Pull to open the back panel.

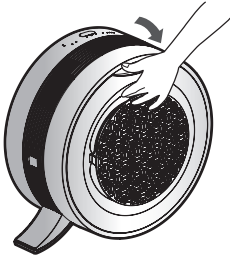

2. Remove the filter from the appliance.

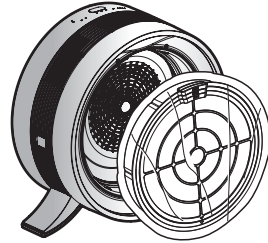

3. Remove the filter from its packaging.

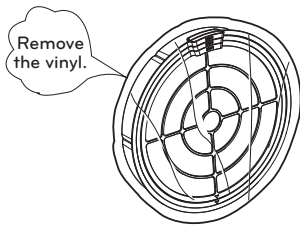

4. Insert the filter behind the bottom tab and snap it into place at the top.

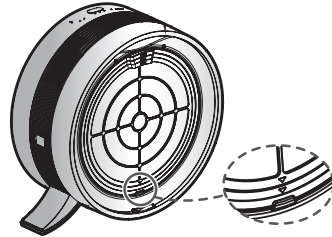

5. Align the back panel at the bottom and then push it back into place.

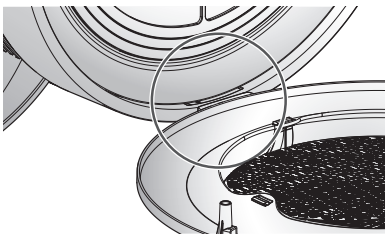

6. Place the air purifier on a stable, level surface with a clear area around it for air to circulate.

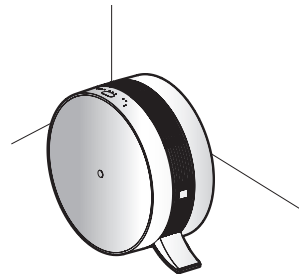

CAUTION



Remove packaging from the filter before use or the product will not be able to circulate air.



OPERATION

Air Purification

The air purifier cleans and refreshes indoor air.

1. Press the  button to turn on the air purifier.
 - A chime sounds, the operation mode indicator LED lights up, and the air quality indicator light turns on.
2. Press the  Speed button to select the desired fan speed.
 - Press the button repeatedly to toggle through the settings: Auto → Low → Medium → High → Auto.
 - The default mode is AUTO.
(The AUTO mode controls fan speed based on the air quality.)

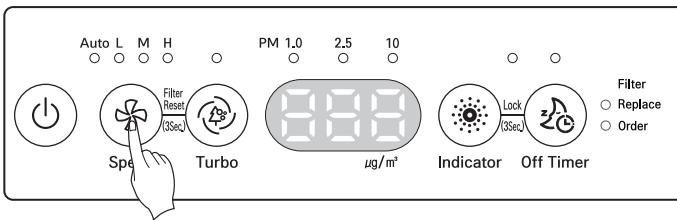

- The sensor takes 30 seconds on initial startup to stabilize and prepare an air quality level reading. After 30 seconds, the indoor air quality and PM density levels are displayed.



Indoor Air Quality Color Range

(contaminated) red → orange → yellow → green (clean)



14 OPERATION

Turbo Function

Use this function to set the air purifier at the highest setting for 30 minutes.

1. Press the button.
2. Press the Turbo button.
 - The air purifier operates at the highest setting for 30 minutes and then returns to the previous setting.
 - If the Turbo function is selected while the air purifier is in the sleep mode, the PM density display turns off after 3 seconds, the Turbo function operates for 30 minutes, and then the product returns to the sleep mode.

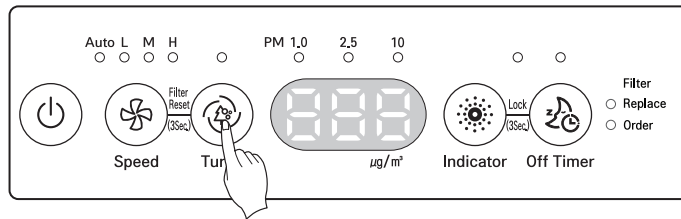

PM Indicator Display

1. Press the Indicator button to check the density of PM10/PM2.5/PM1.0.
 - Pressing the button repeatedly toggles through to check the density of PM10 → PM2.5 → PM1.0 in turn. The selected density displays for 10 seconds before the display reverts to the highest measured PM level.

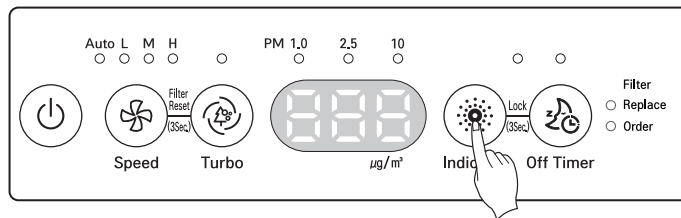

2. Check the dust particle size LED indicators.
 - PM density is displayed based on the dust density result with the highest contamination level.
For example, if PM10 density is 100 (normal), PM2.5 is 50 (bad), and PM1.0 is 30 (normal), the value for PM2.5 is displayed for PM density.

Air Quality Indicator Light

Overall indoor air quality is displayed as one of four colors depending on the contamination level of PM10, PM2.5, PM1.0, and odors.

(contaminated) red → orange → yellow → green (clean)

- The color that the air quality indicator light displays is based on the worst level among PM10, PM2.5, PM1.0, and odor.



Indoor Air Quality Levels

Overall air quality	Status	Dust density (unit $\mu\text{g}/\text{m}^3$)			Odor density
		PM 10	PM 2.5	PM 1.0	Odor
Red	Very Bad	Equal or above 255	Equal or above 56	Equal or above 56	Strong
Orange	Bad	155~254	36~55	36~55	↓
Yellow	Normal	55~154	13~35	13~35	
Green	Good	0~54	0~12	0~12	Weak

* PM density ranges from 8 to 999 in increments of 1. PM density values follow the data sheets provided by the sensor supplier.

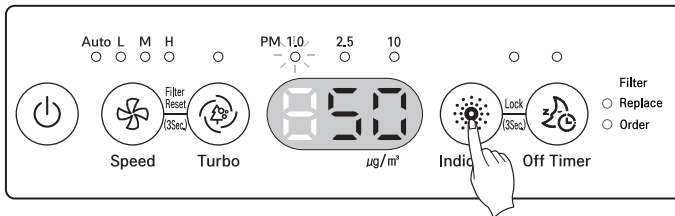

- In the example above, the PM1.0 density displays at $50 \mu\text{g}/\text{m}^3$ (a bad or orange level) and the dust particle size LED indicator for PM1.0 is lit. This indicates that the PM1.0 level is higher than the PM10 or PM2.5 levels. If all the PM density levels are normal/good and the air quality indicator light is orange/red, the level of odors is very high.



NOTE

- PM10 and PM2.5 density levels follow standards provided by the U.S. EPA (Environmental Protection Agency).
 - The overall air quality level displayed on the product may differ from the level announced by the EPA.
- The PM density level for PM1.0 is displayed in the same manner as the PM density level for PM2.5 (using standards developed by LG Electronics).
- The displayed density of PM10 / PM2.5 could differ from the forecast of the EPA and from other measurement devices or products.
 - Indicated dust concentration values can differ from each other depending on the differences in dust measuring methods and also from real dust concentration levels.
 - The assessment of dust density was made against dust used for LG Electronics standards tests.
- The use of products which generate steam and micro particles (humidifiers, cooling devices, sprayers, etc.) can change the micro dust density.
- Because the indoor air quality display shows the overall dust and odor level, it could differ from the density value of PM10, PM2.5, and PM1.0
- Even in the same space, the PM10 density value could differ from other products due to air circulation.
- The displayed PM density value could change depending on the installation environment (including the presence of sofas, beds, carpets, vacuum cleaners, humidity, smoke, oils, and other factors).
- The displayed density value of PM10/PM2.5/PM1.0 could change depending on the surrounding environment (construction site, roadside, factory, etc.)
- The density of micro dust could be higher near exit doors, windows, and vents or anywhere where outside air enters.
- Do not clean the sensor with anything but water. Doing so may cause product failure.

16 OPERATION

Off Timer Function

Use this to set the air purifier in sleep mode before it turns off automatically.



1. Press the  button to turn on the air purifier.
2. Press the  Off Timer button to set the amount of time in sleep mode until the air purifier automatically turns off.
 - The amount of time in sleep mode can be set by pressing the Off Timer button repeatedly to toggle through the options: 2 hours, 4 hours, 8 hours, 12 hours, disabled (reverts to normal display).
 - For example, if set for two hours the product operates for two hours in sleep mode then automatically turns off.

Once Off Timer is set, only the Off Timer LED is lighted. All other lights on the product, including the air quality light, are turned off. The fan is maintained at a low speed to keep noise to a minimum. Once Off Timer is set, pressing the Off Timer button again displays the set turn off time and wakes the display up.

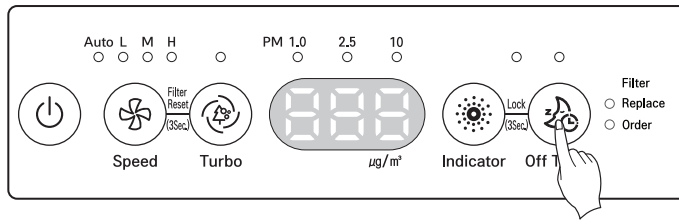
3. To disable the Off Timer function, press the Off Timer button repeatedly until 12 appears in the display. Press once more to disable the function and return the display to normal.



Lock Function

1. Press the  button.
2. Press and hold the  Indicator and  Off Timer buttons at the same time for 3 seconds or until a beep sounds and the LED lights up.
 - The Lock function helps protect the product from unwanted operation by children or others.
 - To disable the Lock function, press and hold the Indicator and Off Timer buttons at the same time for three seconds. A beep sounds and the LED turns off when the Lock function is disabled.
 - The Lock function cannot be set while the power cord is unplugged.

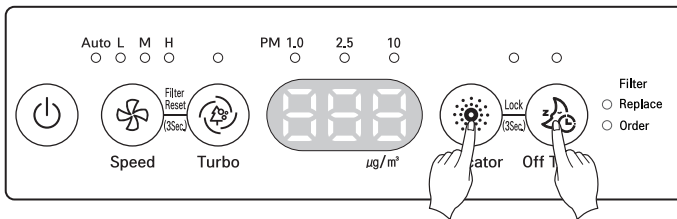



18 OPERATION

Filter Life Light

The Filter Life light turns on based on the operating time.

The orange light turns on after 3,600 - 4,000 hours.

It is time to order a replacement filter.

The red light turns on after 4,000 hours.

It is time to replace the filter.



If the Light is Red

1. Press the power button to turn off the product and then unplug the product
2. Open the back panel of the product and check the filter. If the filters are contaminated, clean or replace them.

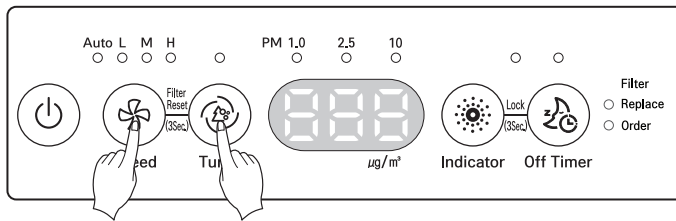
Refer to the Maintenance section of this manual for instructions on cleaning and replacing the filters.



Resetting the Filter Life Light

Press and hold the  Speed and  Turbo buttons at the same time for 3 seconds or longer (Filter Reset function).



MAINTENANCE

Cleaning the Filters

1. Turn off the power and unplug the appliance.
Then pull open the back panel.

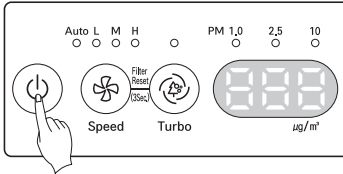

2. Pull the filter set by the top handle to remove it from the appliance.
 - Dust may accumulate on the filter net.
 - Before disassembling filter set, move the filters to a convenient location for vacuuming.
 - Place a newspaper or paper towel down to catch any loose dust.

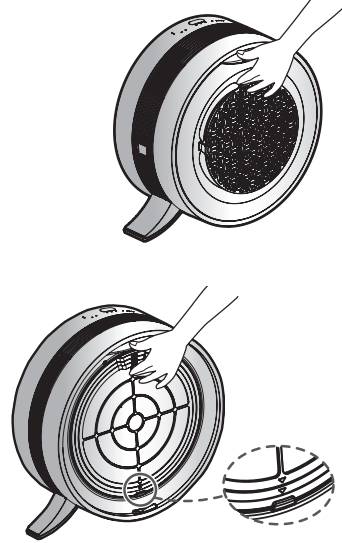

3. While holding the filter case over the newspaper, press downward on the handle of the pre-filter to separate it from the filter set.

Clean the pre-filter using a vacuum cleaner or brush.
If the filter is very dirty, rinse it under running water after cleaning it with a vacuum cleaner.

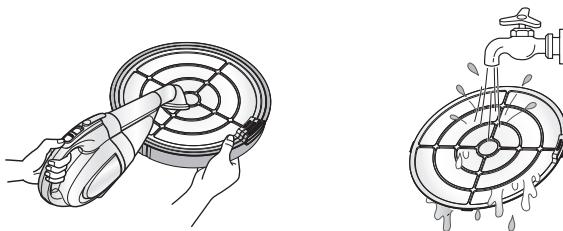
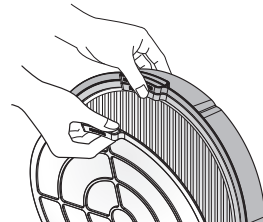

⚠ CAUTION

- Allow pre-filter to dry completely, out of direct sunlight, before reinstalling.
- Do not use pre-filter while damp. Doing so may cause odor.
- Do not operate air purifier without pre-filter installed.



ENGLISH

20 MAINTENANCE

- Do not wash the PuriCare Main Filter or the deodorizing filter with water. Replace them when they become very dirty. Do not expose them to water during operation.
- The life-expectancy of filters may differ depending on the usage environment.

4. Next, remove the PuriCare Main Filter (if replacing the entire filter set).

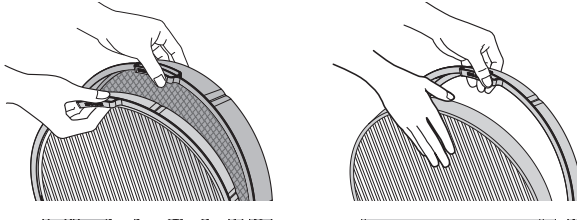

5. Finally, disassemble the deodorizing filter (if replacing the entire filter set).

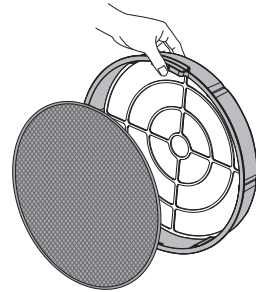

6. After cleaning or replacing filters, assemble the filters in the set in the reverse order from removing them. Be sure to insert the filters behind the bottom tab and align the filter handles at the top of the product.

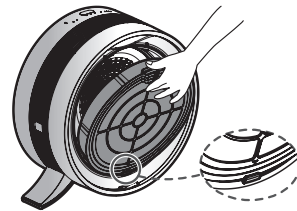

7. Reassemble the back panel by aligning the bottom and then snapping the panel up into place.

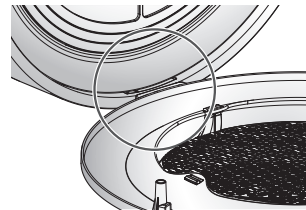

Filter Maintenance Schedule

Filter types	Classification	Cleaning cycle	Cleaning Method
Pre-Filter	washable	about every month	Clean pre-filter with vacuum cleaner or brush, followed by rinsing under running water if very dirty.
PuriCare Main Filter	not washable, replace	about every year	* The replacement cycle for PuriCare Main Filter and Deodorizing Filter may vary depending on the usage environment.
Deodorizing Filter			

* Contact an LG Customer Information Center for replacement filters.

Cleaning the Exterior

Wipe the Air Purifier with a soft cloth and warm water.

The air inlet especially can accumulate dust and should be cleaned periodically.

CAUTION

- Do not clean the body or display using products containing bleach or other alkalines.
- Do not clean the surface of the Air Purifier using sulfuric acid, hydrochloric acid or organic solvents (thinners, kerosene, or others). Do not put stickers on the surface. Doing so may damage the surface of the product.
- Do not use abrasive pads or cloths when cleaning. They may scratch the surface of the product.
- Do not allow water inside product while cleaning the exterior. Turn off power and unplug the power cord before cleaning. (Always check whether fan is moving.)



22 MAINTENANCE

Cleaning the Sensor

Turn off and unplug the product.

Open the dust sensor cover.

Clean the dust sensor lens with cotton swab.
(Clean once every six months.)

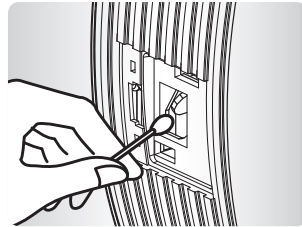
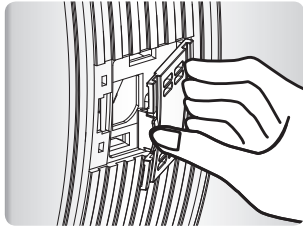

CAUTION

- Use only water to clean the sensor. Failure to follow this warning can result in product failure.



Storing the Product

If the product will not be used for an extended period, store it in a dry place out of direct sunlight.

1. Press the  button to turn on the air purifier.
 - Run the air purifier for an hour on a clear day to remove any musty odor inside the product.

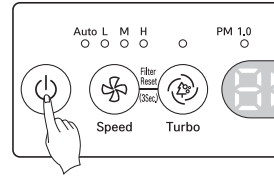

2. Press the  button to turn off the air purifier and then unplug it.

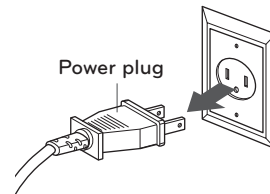

3. Remove the filters and store them tightly in a vinyl bag out of direct sunlight.
 - If the filters are stored in a humid place, they may take on a musty or mildewy odor.

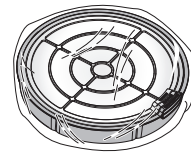

4. Clean the air purifier before storing it. Store the appliance in its vinyl cover to prevent any dust or foreign objects from getting inside.
 - Use a soft cloth when cleaning the appliance to avoid scratching the surface.
 - Store the appliance in a cool area out of direct sunlight.

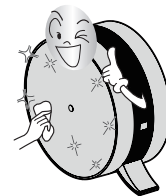

5. Do not store the product where it will be exposed to high humidity or direct sunlight.
 - Doing so may result in odor, product deformation, or product malfunction.



TROUBLESHOOTING

Before Calling for Service

If there is a problem with the product, check the following first before calling for service.

Problem	Possible Cause	Solutions
Air purifier does not turn on	<ul style="list-style-type: none"> • Power cord not plugged in • Incorrect power rating 	<ul style="list-style-type: none"> • Plug cord securely into socket. • Make sure outlet is rated for 115V.
Air output is weak, product makes a noise	<ul style="list-style-type: none"> • Pre-filter is clogged • Dust accumulation on the pre-filter 	<ul style="list-style-type: none"> • Clean the pre-filter. • Replace the pre-filter.
Air purification does not work well	<ul style="list-style-type: none"> • Indoor air quality is very bad • Dust has built up on the pre-filter • Usage area is too large • Nearby objects are blocking air circulation • The product is installed in a corner 	<ul style="list-style-type: none"> • Ventilate the room before using the air purifier. • Clean or replace the pre-filter. • Use the product in a smaller area or an area more protected from the influx of outside air. • Remove nearby obstacles or move the product to a different location. • Move the product.
Strange odor coming from air outlet	<ul style="list-style-type: none"> • Installed in area with heavy smoke or odors • Odor coming from deodorizing filter 	<ul style="list-style-type: none"> • Very heavy smoke or odors may degrade the performance of the filters. Ventilate the area before using the air purifier. • Replace the deodorizing filter.
There is an odor, but the Indicator lamp does not change.	<ul style="list-style-type: none"> • Gas sensor may not respond to food odors as harmful 	<ul style="list-style-type: none"> • Gas sensor may not respond to food odors as harmful, but odors are removed by the deodorizing filter.
Air quality shows red continuously	<ul style="list-style-type: none"> • Air purifier may be unable to process amount of contamination in air • Water or oil sprayed near air purifier 	<ul style="list-style-type: none"> • Try moving product to another room to clear the indicator. • Do not spray water or oil near the air purifier.
Buttons do not work	<ul style="list-style-type: none"> • Lock function is enabled 	<ul style="list-style-type: none"> • Press and hold Indicator and Off Timer for 3 seconds to disable the Lock function.



Problem	Possible Cause	Solutions
There has been no change in micro dust concentration.	<ul style="list-style-type: none"> • Sensor may be dirty or blocked by foreign material • Air purifier may be in enclosed area 	<ul style="list-style-type: none"> • See instructions for cleaning sensor. • Indoor air quality may stay the same in an enclosed area.
The fine dust concentration value keeps showing high.	<ul style="list-style-type: none"> • Air purifier installed in area with constant influx of outside air 	<ul style="list-style-type: none"> • Levels can remain high in areas where there is a constant influx of outside air.
Air quality light remains red/orange while PM levels show low/normal	<ul style="list-style-type: none"> • Air quality issue is from odor 	<ul style="list-style-type: none"> • The air quality indicator is an overall evaluation based on odor and dust. If an odor is strong while PM levels are low, the light may remain on red/orange.
The air quality indicator differs from the EPA guide	<ul style="list-style-type: none"> • The air purifier and EPA air quality values are measured differently 	<ul style="list-style-type: none"> • The EPA guide indicates an average value during a given time period and the air purifier's air quality indicator measures and displays on a real-time basis.
The filter produces odors.	<ul style="list-style-type: none"> • The deodorizing filter has become dirty • The air purifier is being used instead of a vent hood while cooking 	<ul style="list-style-type: none"> • Replace the filter. Filter life-expectancy can vary based on usage environment. • Filter life can be greatly reduced if the air purifier is used while cooking strong-smelling or oily food. Do not use the product in place of a vent hood. Ventilate the area during cooking to remove strong odors and oily splatter, then use the air purifier to eliminate any remaining odors.

26 WARRANTY

WARRANTY (USA)

ARBITRATION NOTICE: THIS LIMITED WARRANTY CONTAINS AN ARBITRATION PROVISION THAT REQUIRES YOU AND LG TO RESOLVE DISPUTES BY BINDING ARBITRATION INSTEAD OF IN COURT, UNLESS YOU CHOOSE TO OPT OUT. IN ARBITRATION, CLASS ACTIONS AND JURY TRIALS ARE NOT PERMITTED. PLEASE SEE THE SECTION TITLED "PROCEDURE FOR RESOLVING DISPUTES" BELOW.

Should your LG Air Purifier fail due to a defect in materials or workmanship under normal home use, during the warranty period set forth below, LG will at its option repair or replace the product. This limited warranty is valid only to the original retail purchaser of the product and applies only when purchased and used within the United States, including U.S. Territories. Proof of original retail purchase is required to obtain warranty service under this limited warranty.

Warranty Period	Scope of Warranty	Remark
One (1) year from date of original retail purchase	Any internal / functional Parts and Labor	LG will provide parts and labor to repair or replace defective parts.
Ten (10) years from date of original retail purchase	Smart Inverter Motor	Parts Only. Customer will be responsible for any labor or in-home service to replace defective parts.

- Replacement products and parts are warranted for the remaining portion of the original warranty period or ninety (90) days, whichever is greater.
- Replacement products and parts may be new or remanufactured.

THIS WARRANTY IS IN LIEU OF ANY OTHER WARRANTY, EXPRESS OR IMPLIED, INCLUDING WITHOUT LIMITATION, ANY WARRANTY OF MERCHANTABILITY OR FITNESS FOR A PARTICULAR PURPOSE. TO THE EXTENT ANY IMPLIED WARRANTY IS REQUIRED BY LAW, IT IS LIMITED IN DURATION TO THE EXPRESS WARRANTY PERIOD ABOVE. NEITHER THE MANUFACTURER NOR ITS U.S. DISTRIBUTOR SHALL BE LIABLE FOR ANY INCIDENTAL, CONSEQUENTIAL, INDIRECT, SPECIAL, OR PUNITIVE DAMAGES OF ANY NATURE, INCLUDING WITHOUT LIMITATION, LOST REVENUES OR PROFITS, OR ANY OTHER DAMAGE WHETHER BASED IN CONTRACT, TORT, OR OTHERWISE.

Some states do not allow the exclusion or limitation of incidental or consequential damages or limitations on how long an implied warranty lasts, so the above exclusion or limitation may not apply to you. This warranty gives you specific legal rights and you may also have other rights that vary from state to state.

THIS LIMITED WARRANTY DOES NOT COVER:

- Service trips to deliver, pick up, or install or repair the product; instruction to the customer on operation of the product; repair or replacement of fuses or correction of wiring or plumbing, or correction of unauthorized repairs/installation.
- Failure of the product to perform during power failures and interrupted or inadequate electrical service.
- Damage caused by leaky or broken water pipes, frozen water pipes, restricted drain lines, inadequate or interrupted water supply or inadequate supply of air.
- Damage resulting from operating the product in a corrosive atmosphere or contrary to the instructions outlined in the product's owner's manual.
- Damage to the product caused by accidents, pests and vermin, lightning, wind, fire, floods, or acts of God.



- Damage or failure caused by unauthorized modification or alteration, or if it is used for other than the intended purpose, or any water leakage where the unit was not properly installed.
- Damage or failure caused by incorrect electrical current, voltage, or plumbing codes, commercial or industrial use, or use of accessories, components, or consumable cleaning products that are not approved by LG.
- Damage caused by transportation and handling, including scratches, dents, chips, and/or other damage to the finish of your product, unless such damage results from defects in materials or workmanship and is reported within one (1) week of delivery.
- Damage or missing items to any display, open box, discounted, or refurbished product.
- Products with original serial numbers that have been removed, altered, or cannot be readily determined. Model and serial numbers, along with original retail sales receipts, are required for warranty validation.
- Increases in utility costs and additional utility expenses.
- Repairs when your product is used for other than normal and usual household use (e.g. commercial use, in offices and recreational facilities) or contrary to the instructions outlined in the product's owner's manual.
- Costs associated with removal of your product from your home for repairs.
- The removal and reinstallation of the product if it is installed in an inaccessible location or is not installed in accordance with published installation instructions, including LG's owner's and installation manuals.
- Damage resulting from misuse, abuse, improper installation, repair, or maintenance. Improper repair includes use of parts not approved or specified by LG.

The cost of repair or replacement under these excluded circumstances shall be borne by the consumer.

TO OBTAIN WARRANTY SERVICE AND ADDITIONAL INFORMATION

For additional product information, visit the LG website at <http://www.lg.com>

For assistance using this product or to schedule service, contact LG Electronics at 1-800-243-0000 (US).

For further assistance, write:
LG Electronics
201 James Record Road
Huntsville, Alabama 35813



28 WARRANTY

PROCEDURE FOR RESOLVING DISPUTES:

ALL DISPUTES BETWEEN YOU AND LG ARISING OUT OF OR RELATING IN ANY WAY TO THIS LIMITED WARRANTY OR THE PRODUCT SHALL BE RESOLVED EXCLUSIVELY THROUGH BINDING ARBITRATION, AND NOT IN A COURT OF GENERAL JURISDICTION. BINDING ARBITRATION MEANS THAT YOU AND LG ARE EACH WAIVING THE RIGHT TO A JURY TRIAL AND TO BRING OR PARTICIPATE IN A CLASS ACTION.

Definitions. For the purposes of this section, references to “LG” mean LG Electronics U.S.A., Inc., its parents, subsidiaries and affiliates, and each of their officers, directors, employees, agents, beneficiaries, predecessors in interest, successors, assigns and suppliers; references to “dispute” or “claim” shall include any dispute, claim or controversy of any kind whatsoever (whether based in contract, tort, statute, regulation, ordinance, fraud, misrepresentation or any other legal or equitable theory) arising out of or relating in any way to the sale, condition or performance of the product or this Limited Warranty.

Notice of Dispute. In the event you intend to commence an arbitration proceeding, you must first notify LG in writing at least 30 days in advance of initiating the arbitration by sending a letter to LG at LG Electronics, USA, Inc. Attn: Legal Department- Arbitration 1000 Sylvan Ave, Englewood Cliffs 07632. You and LG agree to engage in good faith discussions in an attempt to amicably resolve your claim. The notice must provide your name, address, and telephone number; identify the product that is the subject of the claim; and describe the nature of the claim and the relief being sought. If you and LG are unable to resolve the dispute within 30 days, either party may proceed to file a claim for arbitration.

Agreement to Binding Arbitration and Class Action Waiver. Upon failure to resolve the dispute during the 30 day period after sending written notice to LG, you and LG agree to resolve any claims between us only by binding arbitration on an individual basis, unless you opt out as provided below. Any dispute between you and LG shall not be combined or consolidated with a dispute involving any other person’s or entity’s product or claim. More specifically, without limitation of the foregoing, any dispute between you and LG shall not under any circumstances proceed as part of a class or representative action. Instead of arbitration, either party may bring an individual action in small claims court, but that small claims court action may not be brought on a class or representative basis.

Arbitration Rules and Procedures. To begin arbitration of a claim, either you or LG must make a written demand for arbitration. The arbitration will be administered by the American Arbitration Association (“AAA”) and will be conducted before a single arbitrator under the AAA’s Consumer Arbitration Rules that are in effect at the time the arbitration is initiated (referred to as the “AAA Rules”) and under the procedures set forth in this section. The AAA Rules are available online at www.adr.org/consumer. Send a copy of your written demand for arbitration, as well as a copy of this provision, to the AAA in the manner described in the AAA Rules. You must also send a copy of your written demand to LG at LG Electronics, USA, Inc. Attn: Legal Department- Arbitration 1000 Sylvan Avenue Englewood Cliffs, NJ 07632. If there is a conflict between the AAA Rules and the rules set forth in this section, the rules set forth in this section will govern. This arbitration provision is governed by the Federal Arbitration Act. Judgment may be entered on the arbitrator’s award in any court of competent jurisdiction. All issues are for the arbitrator to decide, except that issues relating to the scope and enforceability of the arbitration provision and to the arbitrability of the dispute are for the court to decide. The arbitrator is bound by the terms of this provision.

Governing Law. The law of the state of your residence shall govern this Limited Warranty and any disputes between us except to the extent that such law is preempted by or inconsistent with applicable federal law.



Fees/Costs. You do not need to pay any fee to begin an arbitration. Upon receipt of your written demand for arbitration, LG will promptly pay all arbitration filing fees to the AAA unless you seek more than \$25,000 in damages, in which case the payment of these fees will be governed by the AAA Rules. Except as otherwise provided for herein, LG will pay all AAA filing, administration and arbitrator fees for any arbitration initiated in accordance with the AAA Rules and this arbitration provision. If you prevail in the arbitration, LG will pay your attorneys' fees and expenses as long as they are reasonable, by considering factors including, but not limited to, the purchase amount and claim amount. Notwithstanding the foregoing, if applicable law allows for an award of reasonable attorneys' fees and expenses, an arbitrator can award them to the same extent that a court would. If the arbitrator finds either the substance of your claim or the relief sought in the demand is frivolous or brought for an improper purpose (as measured by the standards set forth in Federal Rule of Civil Procedure 11(b)), then the payment of all arbitration fees will be governed by the AAA Rules. In such a situation, you agree to reimburse LG for all monies previously disbursed by it that are otherwise your obligation to pay under the AAA Rules. Except as otherwise provided for, LG waives any rights it may have to seek attorneys' fees and expenses from you if LG prevails in the arbitration.

Hearings and Location. If your claim is for \$25,000 or less, you may choose to have the arbitration conducted solely on the basis of (1) documents submitted to the arbitrator, (2) through a telephonic hearing, or (3) by an in-person hearing as established by the AAA Rules. If your claim exceeds \$25,000, the right to a hearing will be determined by the AAA Rules. Any in-person arbitration hearings will be held at a location within the federal judicial district in which you reside unless we both agree to another location or we agree to a telephonic arbitration.

Opt Out. You may opt out of this dispute resolution procedure. If you opt out, neither you nor LG can require the other to participate in an arbitration proceeding. To opt out, you must send notice to LG no later than 30 calendar days from the date of the first consumer purchaser's purchase of the product by either: (i) sending an e-mail to optout@lge.com, with the subject line: "Arbitration Opt Out" or (ii) calling 1-800-980-2973. You must include in the opt out e-mail or provide by telephone: (a) your name and address; (b) the date on which the product was purchased; (c) the product model name or model number; and (d) the serial number (the serial number can be found (i) on the product; or (ii) online by accessing <https://www.lg.com/us/support/repair-service/schedule-repair-continued> and clicking on "Find My Model & Serial Number").

You may only opt out of the dispute resolution procedure in the manner described above (that is, by e-mail or telephone); no other form of notice will be effective to opt out of this dispute resolution procedure. Opting out of this dispute resolution procedure will not affect the coverage of the Limited Warranty in any way, and you will continue to enjoy the full benefits of the Limited Warranty. If you keep this product and do not opt out, then you accept all terms and conditions of the arbitration provision described above.



ENGLISH





The energy efficiency of this ENERGY STAR qualified model is measured based on a ratio between the model's CADR for Dust and the electrical energy it consumes, or CADR/Watt.

