

PURCHASER	P.O. #	DATE
PROJECT	LOCATION	
ENGINEER	ARCHITECT	
SUBMITTED BY	FOR APPROVAL	FOR REFERENCE

ITEM	PLAN DESIGNATION	QUANTITY	COOLING BTU/H	VOLTAGE	FRIEDRICH MODEL

Comfort & Convenience

- Convenient control from your smartphone or computer via FriedrichLink® (required accessory sold separately)
- 24-hour timer
- Up to 4 cooling and 4 fan-only speeds on select models†
- Automatic fan speed adjustment
- Auto-changeover from cool to heat; heat to cool to maintain set temperature (Kühl+ models except EQ08)
- 8-way air flow control
- Temperature readout can display set temperature and room temperature
- LCD panel auto dims if not in use
- LCD settings lockout option (ON/OFF)
- Premium remote control allows user to activate schedule, adjust temperature, adjust fan speed or select auto-fan; can also switch from cool to heat and heat to cool (Kühl + models)

Sound Reduction Technology

- Steel inner wall and extra dense insulation materials block outdoor noise
- Vibration isolating design and components diminish traditional operating sound levels
- Precision engineering maximizes air flow while delivering ultra quiet operation

Maintenance & Installation

- Check filter reminder and error code storage
- Same sleeve dimensions for 30+ years for easy replacement
- Slideout chassis for more permanent installation and easier access for maintenance
- Installs in a window or in-wall
- Includes heavy-duty window installation hardware (optional accessory on Kühl+ models)
- Rugged hardboard side panels or (heavy duty side curtains on SQ and EQ models) for a more permanent installation
- Power cord can run left or right
- Defrost control protects coil against freeze up
- Firm grip handles for easier chassis installation and removal

Energy Management & Compliance

- Convenient control from your smartphone or computer via FriedrichLink™ (optional accessory sold separately)
- 2 ready-to-go 7-day energy management programs
- Autofan mode saves money by conserving energy
- ENERGY STAR® qualified models, including heat pumps
- Environmentally-friendly R-410A refrigerant used in all models
- Recyclable packaging
- RoHS compliant

Safety & Security

- EntryGard™ anti-intrusion protection - secures chassis to the sleeve with a steel retaining wire to deter 'kick-in' intrusion
- Power cord current leakage protected
- Aluminum outside grille
- Insect barrier*

Health & IAQ

- Superior fresh air intake and stale air exhaust vent*
- Washable, antimicrobial air filter
- Premium carbon filter provides superior air filtration with ratings as high as MERV 6, while also adsorbing odors, and reducing ozone and VOCs when used in conjunction with standard filter
- Hinged door for easy filter access



* Feature not available on SQ and EQ models.

**Nut driver not required for Kühl SQ and EQ models.

Specifications

★ ENERGY STAR® models

Model	Cooling Btu	Heating Btu	Volts Rated	Cooling Amps	Cooling Watts	Heating Amps	Heating Watts	Energy Efficiency Ratio EER	Estimated Yearly Operating Cost	COP	Moisture Removal-Pints/HR	CFM	Sleeve	Net Wt. lbs.	Ship Wt. lbs.
Kühl®															
★ SQ05N10B	5200	-	115	4.7	464	-	-	11.2	\$42	-	0.5	190	Q	72	85
★ SQ06N10B	5700	-	115	4.7	509	-	-	11.2	\$46	-	0.5	190	Q	72	85
★ SQ08N10B	7900	-	115	6.4	705	-	-	11.2	\$63	-	1.2	200	Q	71	84
SQ10N10	9600	-	115	9.2	980	-	-	9.8	\$88	-	2.1	240	Q	71	84
★ SS08N10B	8000	-	115	6.1	696	-	-	11.5	\$63	-	1.9	255	S	99	121
★ SS10N10B	9700	-	115	7.8	858	-	-	11.3	\$77	-	2.5	300	S	106	128
★ SS12N10B	12000	-	115	9.7	1062	-	-	11.3	\$96	-	3.0	300	S	112	134
★ SS14N10A	13500	-	115	12.0	1250	-	-	10.8	\$113	-	4.0	275	S	116	133
★ SS12N30B	12000/12000	-	230/208	4.9/5.2	1062/1062	-	-	11.3/11.3	\$96	-	3.4	325	S	112	134
★ SS16N30	15500/15200	-	230/208	6.5/7.1	1449/1421	-	-	10.7/10.7	\$130	-	4.8	350	S	116	136
★ SM15N10B	15000	-	115	12.0	1339	-	-	11.2	\$121	-	3.5	360	M	141	154
★ SM18N30	17500/17200	-	230/208	7.4/8.0	1635/1607	-	-	10.7/10.7	\$147	-	4.6	350	M	140	161
★ SM21N30B	20500/20000	-	230/208	9.3/10.2	2092/2062	-	-	9.8/9.7	\$188	-	6.0	425	M	132	153
SM24N30A	23500/23200	-	230/208	12.7/13.6	2765/2730	-	-	8.5/8.5	\$249	-	7.1	430	M	152	173
★ SL24N30B	24000/23800	-	230/208	10.8/11.4	2449/2429	-	-	9.8/9.8	\$220	-	7.0	640	L	191	212
★ SL28N30B	28000/27600	-	230/208	13.0/14.0	2857/2875	-	-	9.8/9.6	\$257	-	8.5	640	L	193	214
SL36N30B	36000/35500	-	230/208	17.5/19.2	4000/3944	-	-	9.0/9.0	\$360	-	12.0	725	L	212	248
Kühl+® (Heat Pump)															
★ YS10N10B*	9500	8000	115	8.2	913	7.3	870	10.4	\$82	2.7	2.0	300	S	109	131
★ YS12N33B	11500/11300	9400/9000	230/208	5.0/5.4	1106/1087	4.6/5.0	1132/1139	10.4/10.4	\$100	2.4/2.3	3.0	375	S	115	136
★ YM18N34B	17500/17200	15500/15000	230/208	7.5/8.1	1683/1654	7.8/8.4	1824/1765	10.4/10.4	\$151	2.5/2.5	5.4	370	M	141	154
★ YL24N35B	24000/24000	22000/22000	230/208	10.8/11.6	2449/2449	10.7/11.4	2391/2391	9.8/9.8	\$220	2.6/2.6	7.0	600	L	197	211
Kühl+® (Electric Heat)															
EQ08N11B	7900	4000	115	6.4	705	11.2	1290	11.2	\$61	-	1.2	200	Q	72	84
ES12N33B	12000/12000	10700/8900	230/208	4.9/5.2	1062/1062	16.0/14.7	3500/2900	11.3/11.3	\$96	-	3.4	325	S	113	128
ES16N33	15500/15200	10700/8900	230/208	6.5/7.1	1449/1421	16.0/14.7	3500/2900	10.7/10.7	\$130	-	4.8	350	S	117	133
EM18N34	17500/17200	13000/10600	230/208	7.4/8.0	1635/1607	19.5/17.0	4200/3500	10.7/10.7	\$147	-	4.6	350	M	141	154
EM24N34A	23500/23200	13000/10600	230/208	12.7/13.6	2765/2730	19.5/17.0	4200/3500	8.5/8.5	\$249	-	7.1	430	M	153	166
EL36N35B	36000/35500	17300/14300	230/208	17.5/19.2	4000/3944	24.0/22.4	5500/4650	9.0/9.0	\$360	-	12.0	725	L	213	246

* Operates on 115 volt and is not equipped with supplemental heat. Will not provide heat at temperatures below 40°F. Friedrich room air conditioners are designed to operate in outdoor temperatures from 60° F to 115° F.

Kühl+ Heat Pump heating information indicates heat pump performance. Kühl+ and Chill+ Electric Heat heating information indicates electric heat strip performance. For Kühl+ Heat Pump electric heating performance refer to corresponding Kühl+ Electric Heat model.

As an ENERGY STAR® partner, Friedrich Air Conditioning Co. has determined that the selected ENERGY STAR® models meet the ENERGY STAR® guidelines for energy efficiency.

The consumer- through the AHAM Room Air Conditioner Certification Program- can be certain that the AHAM Certification Seal accurately states the unit's cooling and heating capacity rating, the amperes and the energy efficiency ratio.

Your operating costs will depend on your utility rates and use. The estimated operating cost is based on a electricity cost of \$.12 per kWh. For more information, visit www.ftc.gov/energy. Due to continuing research in new energy-saving technology, specifications are subject to change without notice.



Installation

Sleeve	Height INCHES	Width INCHES	Depth with Front INCHES	Shell Depth to Louvers INCHES	Minimum Extension Into Room* INCHES	Minimum Extension Outside * INCHES	Window Width INCHES		In-wall Installation Finished Hole INCHES			Carton Dimensions INCHES		
			A	B			Minimum**	Maximum	Height	Width	Max. Depth	C	Height	Width
Q	14"	19 3/4"	21 3/8"	8 1/2"	5 1/2"	10 3/4"	22"	42"	14 1/4"	20"	8 1/2"	18 3/4"	25 1/2"	22 3/4"
S	15 15/16"	25 15/16"	29"	8 3/4"	5 3/4"	16 15/16"	27 3/8"	42"	16 3/16"	26 3/16"	7 3/8"	19"	34 1/2"	29"
M	17 15/16"	25 15/16"	29"	8 3/4"	5 3/4"	16 15/16"	27 3/8"	42"	18 3/16"	26 3/16"	7 3/8"	21"	34 1/2"	29"
L	20 3/16"	28"	35 1/2"	16 1/2"	5 3/8"	18 15/16"	29 7/8"	42"	20 3/8"	28 1/4"	15 1/8"	24 1/2"	38 7/8"	31 5/8"







* Minimum extensions when mounted in a window.

** Minimum widths achieved using one side curtain assembly as opposed to both in a standard installation.

† Sleeve P1 does not have In-wall hole dimensions, as these units are fixed chassis and should not be installed In-wall.

NOTE: S, M and L sleeves may be installed in window with no side kits if properly installed.

Circuit Rating/ Breaker

Model	Circuit Rating Breaker or T-D Fuse	Plug Face (NEMA#)	Power Cord Length (ft.)	Wall Outlet Appearance
CP05G10A	125V-15A	5 -15P	6 1/2	
CP06G10A, CP08G10A, CP10G10A, CP12G10A and CP15G10A. EP08G11A. All SQ MODELS. EQ08N11B. SS08N10B, SS10N10B, SS12N10B and SS14N10A. YS10N10B. SM15N10B.	125V - 15A	5- 5P	6	
CP18G30A	250V - 15A	6 - 15P	4 1/2	
SS12N30B and SS16N30, SM18N30 and SM21N30B. SL24N30B.			6	
CP24G30A. EP12G33A, EP18G33A and EP24G33A.	250V - 20A	6 - 20P	4	
SM24N30A. SL28N30B. ES12N33B and ES16N33. YS12N33B.	250V - 20A	6 - 20P	6	
SL36N30B. EM18N34, EM24N34A and EL36N35B. YM18N34B and YL24N35B.	250V - 30A	6 - 30P	6	

Sleeve Dimensions Drawing

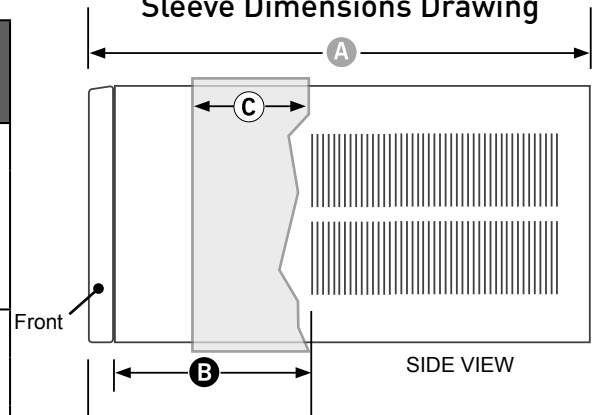

Room Air Conditioner Model Identification Guide

SL28N30A

