

USE & CARE GUIDE



E Series Built-In Ovens





## Contents

Wolf E Series Built-In Ovens .....	3
Safety Instructions .....	4
E Series Oven Features .....	6
E Series Oven Operation .....	9
E Series Oven Care .....	32
Wolf Cooking Guide .....	34
Troubleshooting Guide .....	37
Service Information .....	38
Wolf Warranty .....	39

Features and specifications are subject to change at any time without notice. Visit our website, [wolfappliance.com](http://wolfappliance.com) for the most up-to-date information.

**IMPORTANT NOTE:** Throughout this guide, dimensions in parentheses are millimeters unless otherwise specified.

## Important Note

To ensure the safe and efficient use of Wolf equipment, please take note of the following types of highlighted information throughout this guide:

**IMPORTANT NOTE** highlights information that is especially important.

**CAUTION** signals a situation where minor injury or product damage may occur if instructions are not followed.

**WARNING** states a hazard that may cause serious injury or death if precautions are not followed.



## Thank You

Your purchase of a Wolf E series oven attests to the importance you place upon the quality and performance of your cooking equipment. We understand this importance and have designed and built your oven with quality materials and workmanship to give you years of dependable service.

We know you are eager to start cooking, but before you do, please take some time to read this use & care guide. Whether you are a beginning cook or an expert chef, it will be to your benefit to familiarize yourself with the safety practices, features, operation and care recommendations of the Wolf E series oven.

Your Wolf E series oven is protected by a warranty that is one of the finest in the industry. Take a moment to read the warranty statement at the end of this guide and refer to it should service become necessary.

**IMPORTANT NOTE:** Performance may be compromised if the electrical supply is less than 240 volts.

### CAUTION

Do not place cookware on oven floor or use aluminum foil or other material to line the oven floor or side walls. Failure to adhere to this notice will damage the porcelain and will void your warranty.

## IMPORTANT INSTRUCTIONS

**IMPORTANT NOTE:** Read all safety instructions before using this appliance.

- Read this use & care guide carefully before using your new built-in oven to reduce the risk of fire, electric shock or injury to persons.
- Ensure proper installation and servicing. This appliance must be properly installed and grounded by a qualified technician.
- Warranty service must be performed by Wolf factory certified service.
- Have installer show you where the fuse or electrical box is located in your home. Learn how and where to shut off the electricity to the oven.
- Use oven only for cooking tasks expected of a home oven as outlined in this guide.
- Always properly clean and maintain the oven as recommended in this guide. Clean only those parts listed in this guide.

### **⚠ CAUTION**

Do not place cookware on oven floor or use aluminum foil or other material to line the oven floor or side walls. Failure to adhere to this notice will damage the porcelain and will void your warranty.

### GENERAL SAFETY REQUIREMENTS

- Always use dry pot holders when removing pans from the oven. Wet or damp pot holders can cause steam burns. Do not let pot holders touch hot heating elements. Do not use a towel or other bulky cloth.
- Exercise caution when opening the oven door. Let hot air or steam escape before looking or reaching into the oven.
- Be sure that the oven cool air intake (located above the door) and oven exhaust vent (located below the door) are unobstructed at all times.
- Position oven racks in desired locations when oven is cool. If a rack must be repositioned after the oven is already hot, be certain oven mitt does not contact a hot heating element in the oven.
- Before using the self-clean feature, remove broiler grill and pan, oven racks, oven rack guides and any other utensils.
- The cooling fan should be operating during the self-clean feature. If you notice that the cooling fan is not operating, contact Wolf factory certified service before using the self-clean feature again.

## IMPORTANT INSTRUCTIONS

### GENERAL SAFETY REQUIREMENTS

- Do not use commercial oven cleaners or oven liner protective coatings, such as aluminum foil, on any part of the oven.
- Do not place cookware on the floor of the oven.
- Do not repair or replace any part of the oven unless specifically recommended in literature accompanying this appliance. All service should be referred to Wolf factory certified service.
- Do not use oven for warming or heating a room.
- Do not leave children alone or unattended in the area where the oven is in use. Never allow children to sit or stand on any part of the oven. Do not let children play with the oven.
- Do not use water on grease fires. Smother any flames with a lid, baking sheet or flat tray. Flaming grease can be extinguished with baking soda or a multipurpose chemical or foam extinguisher.
- Do not heat unopened food containers as they could burst and cause injury.
- Do not store combustible, flammable or explosive materials in the oven or adjacent cabinets.
- Do not use abrasive or caustic cleaners or detergents on this appliance as these may cause permanent damage. Do not use aerosol cleaners as these may be flammable or cause corrosion of metal parts.
- Do not clean the oven gasket, because rubbing or moving the gasket may eliminate the required tight door seal.
- Do not wear loose or hanging apparel while using the oven.
- Do not touch heating elements or interior surfaces of the oven. Heating elements may be hot even though they are dark in color. Interiors of the oven become hot enough to cause burns. During and after use, do not touch, or let clothing or other flammable materials contact heating elements or interior surfaces of the oven until they have had sufficient time to cool. Other surfaces of the oven may become hot enough to cause burns. These surfaces include the oven door, window, oven vent and the surface near the oven vent.

#### **⚠ CAUTION**

**Do not store items of interest to children above the oven, as they could climb on the appliance to reach items and be injured.**

## E Series Single Oven Features

- Framed and unframed door styles with tubular handle.
- Black glass model with tubular handle.
- Can be installed in a standard or flush inset application.
- Crafted of heavy-duty stainless steel.
- Dual convection oven with two fans for even heat distribution.
- Ten cooking modes—bake, roast, broil, convection bake, convection roast, convection broil, convection and proof—bake stone and dehydration modes require accessory.
- Cobalt blue porcelain oven interior.
- Six-level rack guides with three adjustable oven racks; one full-extension easy glide, one full-extension door glide and one standard.
- Large viewing, double-pane window and dual halogen interior lights.
- Hidden bake element and recessed broil element.
- Temperature probe and broiler pan.
- Self-clean, delayed start, timed cook and Sabbath features.
- Balanced door hinge system for smooth opening and closing.
- Two and five year residential warranty—exclusions apply, see warranty at the end of this guide.



This appliance is certified by Star-K to meet strict religious regulations in conjunction with specific instructions found on [www.star-k.org](http://www.star-k.org).

## E SERIES BUILT-IN SINGLE OVEN

Model SO30-2U/S shown

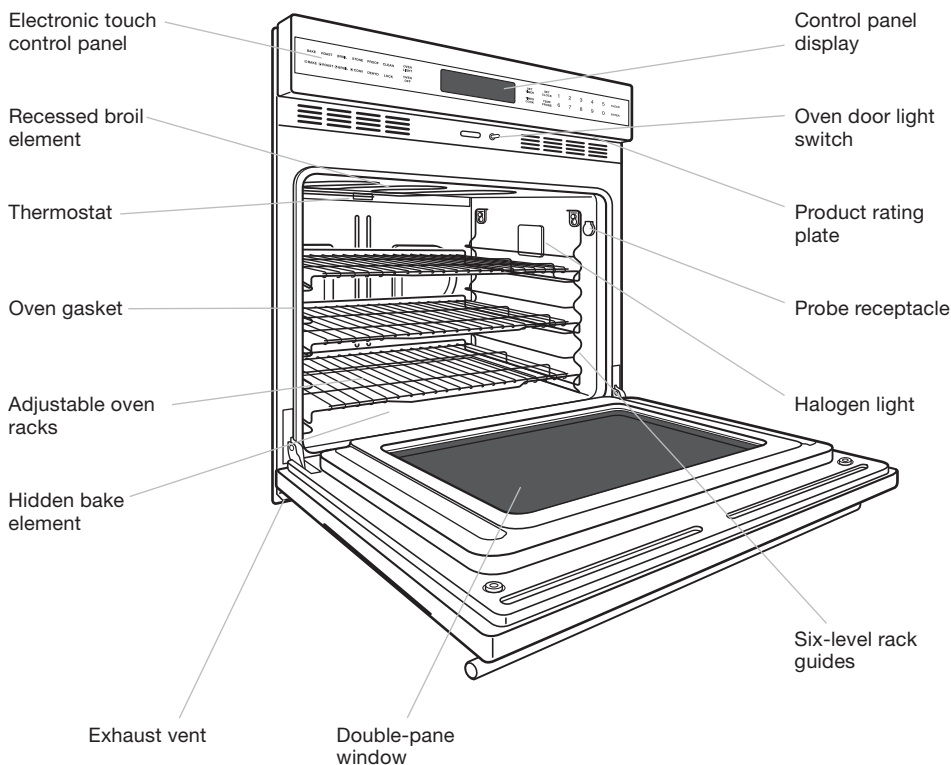

## E Series Double Oven Features

- Framed and unframed door styles with tubular handles.
- Black glass model with tubular handles.
- Can be installed in a standard or flush inset application.
- Crafted of heavy-duty stainless steel.
- Dual convection upper oven with ten cooking modes—bake, roast, broil, convection bake, convection roast, convection broil, convection and proof—bake stone and dehydration modes require accessory.
- Lower oven has four standard cooking modes—bake, roast, broil and proof.
- Cobalt blue porcelain oven interiors.
- Six-level rack guides with three adjustable oven racks; one full-extension easy glide, one full-extension door glide and one standard in each oven.
- Large viewing, double-pane windows and dual halogen interior lights.
- Hidden bake elements and recessed broil elements.
- Temperature probe and broiler pan.
- Self-clean, delayed start, timed cook and Sabbath features.
- Balanced door hinge system for smooth opening and closing.
- Two and five year residential warranty—exclusions apply, see warranty at the end of this guide.

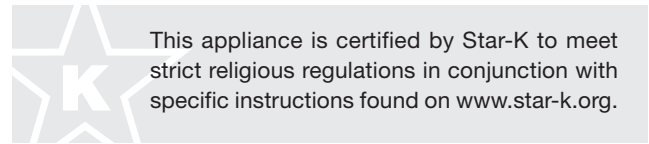

## E SERIES BUILT-IN DOUBLE OVEN

Model DO30-2U/S shown

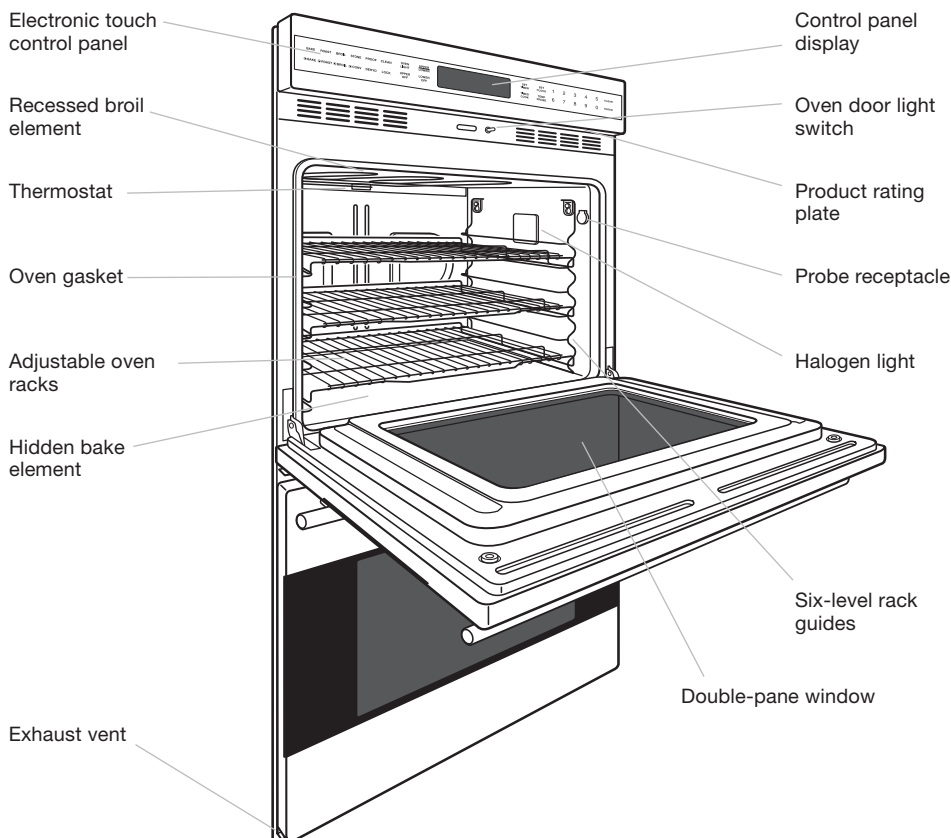

### E Series Oven Features

- Multiple cooking modes, each dedicated to giving the best results for a specific kind of cooking. This is the ultimate in oven performance, fine-tuned for your individual cooking preferences.
- Large, easy-to-see and read graphics on control panel.
- Electronic responses and directions on the control panel are displayed using clear, concise words.
- Large cooking cavity increases usable oven capacity for extra-large baking pans and oversized turkeys.
- Bake element located beneath the oven floor makes it easy to access any spillover.
- Bottom rack can be fully extended, making it easier and safer to reach food in a hot oven.

**⚠ CAUTION**  
 Do not place cookware on oven floor or use aluminum foil or other material to line the oven floor or side walls. Failure to adhere to this notice will damage the porcelain and will void your warranty.

### Electronic Control Panel

The electronic control panel features touch pads for cooking modes and other operations. Refer to the illustrations below.

For the single oven, you can begin a cooking mode by simply touching the desired mode on the control panel. For double ovens, touching the desired mode will automatically turn on the upper oven. To turn on the lower oven, first touch the UPPER/LOWER touch pad so that the lower oven icon is selected in the control panel display. Then touch the desired mode to turn on the lower oven.

The control panel can be locked to keep it child-safe and prevent the oven from accidentally being turned on. To lock the control panel, press and hold LOCK for 3 seconds. All controls except for OFF and LOCK will be locked and silenced. 'KEY LOCKED' will appear in the control panel display when a touch pad is pressed while locked. To unlock, press and hold LOCK for 3 seconds.

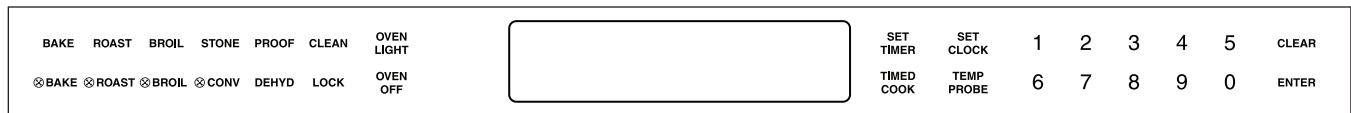

Single oven control panel.

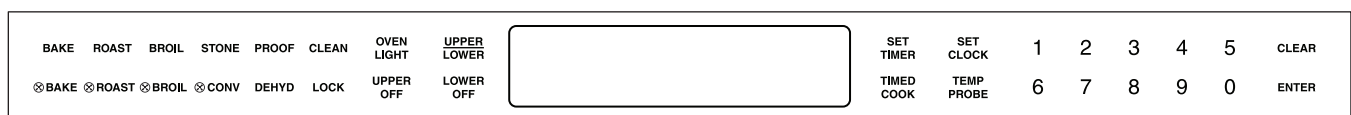

Double oven control panel.



## Oven Operation

### CHANGING OVEN TEMPERATURE

The oven temperature can be changed at any time once a cooking mode has been selected.

- 1) Touch the number pads to enter in the new temperature.
- 2) Touch ENTER.

This will change the oven temperature immediately. If ENTER is not touched, the oven will automatically switch to the new oven temperature within five seconds.

### RAPID MODE CHANGE

The oven has the ability to quickly change cooking modes. This is a method of switching cooking modes without turning the oven on and off. If one mode is already started, instead of turning the oven off to change cooking modes, simply touch the desired cooking mode touch pad.

### OVEN PREHEAT

**IMPORTANT NOTE:** During preheat, the oven is heated in a manner unsuitable for cooking.

The oven preheat feature is used for all cooking modes except broil and convection broil. In order not to damage food, preheating will not occur once the oven reaches its set temperature. Increasing oven temperature during cooking will result in the oven taking a very long time to reach the new temperature. To reach a new temperature quickly, touch OFF to exit the current mode. Touch ON, then the desired cooking mode and enter a new temperature of at least 50° higher than the previous operating temperature.

### AUTOMATIC SHUT OFF

As a safety feature, the E series oven(s) will shut off automatically after 12 hours of continual use, unless dehydration mode or Sabbath feature is in use.

### BEFORE USING FOR THE FIRST TIME

Before using your E series oven for the first time, clean thoroughly with hot water and a mild detergent. Rinse and dry with a soft cloth. Refer to care recommendations on page 33.

Turn on the oven when prompted, set the language by touching 1 for English, 2 for German, 3 for French, 4 for Spanish or 5 for Italian.

Next, set the single oven or the upper cavity of the double oven to  ROAST (convection roast) at 550°F (260°C) for one hour. For a double oven, wait until the upper oven has finished convection roasting for one hour, and then set the bottom oven to ROAST at 550°F (260°C) for one hour. Refer to page 17 for convection roast mode instructions and page 14 for roast mode. Allow the oven to cool gradually with the door closed.

This process will burn off any residual oil and grease used during the manufacturing process. A small amount of smoke and odor may be noticed during the initial break-in period. The oven door can be opened after the oven has cooled significantly. The first time the self-clean feature is used, there will be further burn-off that may create smoke and odor.

## Time-of-Day Clock

Immediately after the oven is installed, set the 12-hour clock to the current time of day. It may need to be reset after a prolonged power failure. The clock is visible on the panel during all modes. If the upper oven timer is set, the clock will not be visible in the upper oven control panel display.

### SETTING CLOCK

- 1) Touch SET CLOCK.
- 2) Touch number pads to set current time of day. A 10-second period of inactivity will result in the oven returning to the original time.
- 3) Touch ENTER and when prompted, touch 1 for AM or 2 for PM.
- 4) Touch ENTER again to start clock.

## Extended Options

The screen scrolls in the order of language, temperature scale, temperature offset, 12/24 hour clock, backlight brightness, chime tone and contrast adjustment.

- 1) Touch and hold SET CLOCK on the control panel for 5 seconds to enter the extended options screens.
- 2) Touch ENTER to scroll through the different option screens.
- 3) When finished selecting all options touch CLEAR to return to the main display.

### LANGUAGE

- 1) When prompted, touch 1 for English, 2 for German, 3 for French, 4 for Spanish or 5 for Italian.

### TEMPERATURE SCALE

The oven can be changed from Fahrenheit (°F) temperature to Celsius (°C) or vice versa.

- 1) When prompted, touch 1 for Fahrenheit (°F) or 2 for Celsius (°C).

### TEMPERATURE OFFSET

The temperature offset option is intended to be adjusted by Wolf factory authorized service only. If you feel your oven is not maintaining the proper set point, contact Wolf customer care at 800-222-7820 for information.

### 12/24 HOUR CLOCK

- 1) When prompted, touch 1 for 12-hour clock or 2 for 24-hour clock.

### BACKLIGHT BRIGHTNESS

- 1) When prompted, touch 1 for low brightness, 2 for medium brightness or 3 for high brightness.

### BACKLIGHT BRIGHTNESS 2 (BLACK GLASS MODELS ONLY)

Adjusts backlight for clock in idle mode.

- 1) When prompted, touch 1 for low brightness, 2 for medium brightness or 3 for high brightness.

### CHIME TONE

There are three different frequency tones for the oven chime.

- 1) When prompted, touch 1 for the low frequency tone, 2 for the medium frequency tone or 3 for the high frequency tone.

### CONTRAST ADJUSTMENT

The contrast can be adjusted to ensure a crisp readout on the control panel display.

- 1) When prompted, touch 1 through 9 on the number pad to adjust the contrast setting to your personal preference.

## Oven Timer

Each oven has a timer which operates independently from the controls and from each other. Only one timer will work at one time. Once a time is set in hours and minutes, the countdown is seen in the control panel display. Only the last minute counts down in seconds.

An audible signal acts as a reminder when the amount of time runs out. To stop the signal, touch CLEAR. The maximum time that can be set is 9 hours and 59 minutes.

### SETTING TIMER

- 1) Touch SET TIMER.
- 2) Touch number pads to set the hours and minutes.
- 3) Touch ENTER or SET TIMER to start. Touch CLEAR at any time to stop the timer and exit.
- 4) Touch SET TIMER while the current timer is still active to restart and set a new time.
- 5) To clear the timer: If oven is off, touch CLEAR. If oven is on, touch SET TIMER, then CLEAR.

## Cooking Modes and Features

E series ovens feature ten cooking modes and multiple features for precise, easy-to-use control. Instructions for setting controls and tips for success are outlined for each mode and feature on the following pages.

### COOKING MODES AND FEATURES

- Bake mode . . . . . 13
- Roast mode . . . . . 14
- Broil mode . . . . . 15
- Convection bake mode . . . . . 16
- Convection roast mode . . . . . 17
- Convection broil mode . . . . . 18
- Convection mode . . . . . 19
- Proof mode . . . . . 20
- Bake stone mode (with accessory) . . . . . 21
- Dehydration mode (with accessory) . . . . . 23
- Delayed start feature . . . . . 25
- Temperature probe feature . . . . . 26
- Timed cook feature . . . . . 28
- Sabbath feature . . . . . 28
- Self-clean feature . . . . . 30

**IMPORTANT NOTE:** The cooking modes and features on the following pages outline the operation for a single oven. For a double oven, follow the same steps as for a single oven, with the exception of cooking modes that can only be used in the upper oven.

For double ovens, to switch from the upper oven to the lower and vice versa, simply touch the UPPER/LOWER touch pad on the control panel. The icon of the selected oven will be highlighted in the control panel display.

## Oven Racks

### OVEN RACK GUIDES

To insert the rack guides in the oven, locate the screws in the oven side walls. Place the rack guide mounting tabs over the screw heads and slide down until the screws are fully seated in the tabs. Refer to the illustration below.

To remove the rack guides, pull the rack guide straight up and then out so that the mounting tabs clear the screw heads. Remove the rack guide from the oven.

**IMPORTANT NOTE:** Remove all oven racks and rack guides before using the self-clean feature. They will discolor if left in the oven during self-clean.

### OVEN RACKS

To insert a rack in the oven, place the rack anti-tip lock under the side rack guide rails. Slide the rack toward the back of the oven and lift up to clear the rack stops. Continue sliding the rack until it is completely inside the oven.

To remove a rack from the oven, slide the rack forward and lift up and out, clearing the rack stops from the side rack guide rails. Refer to the illustration below.

The bottom oven rack has a full-extension capability. With the rack in rack guide position 1, slide it onto the stainless steel door guides. This adds stability to the rack when using a heavy pan for large meat and poultry. With the rack fully extended, it is easier to safely reach hot food. Refer to the illustration below for rack guide positions.

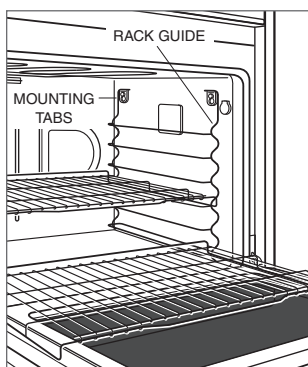

Oven rack guide removal.

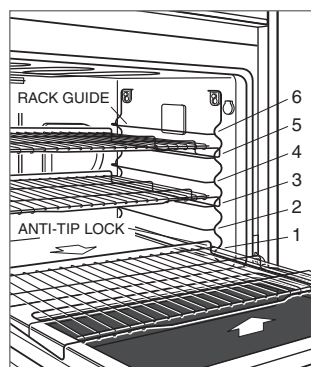

Oven rack positions and full extension bottom rack.

### OVEN RACK ARRANGEMENT

One of the factors affecting optimum cooking results is the level of rack placement in the oven. Rack position 1 is closest to the bottom and position 6 is closest to the top. The Wolf cooking guide on pages 34–36 provides suggested rack positions for optimum results.

- When using only one rack, place rack in the center of the oven.
- When using only one rack for roasting meats, place rack on rack guide position 1, 2 or 3.
- When using two or three racks, place at least one rack position between them.
- When positioning racks, the easy glide rack can be placed in any position except position 1. The full-extension bottom rack was specifically designed to be placed in position 1.

### ▲ CAUTION

Use dry pot holders when handling oven racks. Racks become hot when the oven is on and hold heat after it is turned off.



## Bake Mode

In bake mode, both the hidden bake element and the broil element are used to heat the air, and they cycle on and off to maintain temperature. This mode is best for single-rack cooking, primarily baked foods. Always use bake mode for your standard recipes. The temperature probe may be used in this mode.

Refer to the Wolf cooking guide on pages 34–36. Use cooking times as a guide for similar foods.

### WOLF TIPS FOR SUCCESS

- Always preheat for bake mode.
- During preheat, convection fans (if applicable) and elements are used to quickly and uniformly heat the oven.
- Use only one rack.
- Allow at least 1" (25) between edge of pan and walls of oven.
- Size, shape and finish of cookware affects baking time.
- Food cooked in dark metal pans cook somewhat faster than food cooked in shiny pans.
- Dark, nonstick pan coatings brown more than light, nonstick coatings.
- Use the interior oven light and window to check browning. Limit frequent door openings to prevent losing heat and lengthening total cooking time.

### ⚠ CAUTION

Do not place cookware on oven floor or use aluminum foil or other material to line the oven floor or side walls. Failure to adhere to this notice will damage the porcelain and will void your warranty.

### SETTING CONTROLS

- 1) Touch **BAKE**. For double ovens, this will turn on upper oven. To turn on lower oven, first touch the **UPPER/LOWER** touch pad so that the lower oven icon is selected in the control panel display. Then touch **BAKE**.
- 2) Oven temperature is preset at 350°F (175°C). Oven begins to heat after 10 seconds. To change oven temperature from the default temperature of 350°F (175°C), immediately enter another temperature using the number pads.
- 3) Touch **CLEAR** once to clear the oven temperature setting; touch **CLEAR** twice to return the oven to the time-of-day display.
- 4) Touch **ENTER** to start the cooking mode immediately.
- 5) Add food when the chime signals that the oven has reached preheat temperature.
- 6) If the temperature probe is used (upper oven only), follow temperature probe feature directions on pages 26–27.
- 7) If the timer is set, the oven will chime when the cooking time is finished. If the timer is not cleared, it will continue to chime every 10 seconds.
- 8) Remove food. Always use dry pot holders when removing hot pans from the oven.
- 9) Touch oven **OFF** to end this mode.

## Roast Mode

In roast mode, both bake and broil elements are used to heat the air, and they cycle on and off to maintain temperature. This is designed especially for roasting less tender cuts of meat that should be covered, such as chuck roasts, lamb shanks, pot roasts and stew meat. The temperature probe may be used in this mode.

Refer to the Wolf cooking guide on pages 34–36. Use cooking times as a guide for similar foods.

### WOLF TIPS FOR SUCCESS

- Always preheat for roast mode.
- During preheat, convection fans and elements are used to quickly and uniformly heat the oven.
- Roasting bags may be used.
- When roasting a large item, such as a turkey, the pan should not cover the entire rack and block heat from circulating naturally.
- Cook stuffed turkeys weighing over 15 lbs (6.8 kg) in roast mode. Always cook stuffing to an internal temperature of 165°F (75°C).

### SETTING CONTROLS

- 1) Touch ROAST. For double ovens, this will turn on upper oven. To turn on lower oven, first touch the UPPER/LOWER touch pad so that the lower oven icon is selected in the control panel display. Then touch ROAST.
- 2) Oven temperature is preset at 350°F (175°C). Oven begins to heat after ten seconds. To change oven temperature from 350°F (175°C), immediately enter another temperature using the number pads.
- 3) Touch ENTER to start the cooking mode immediately.
- 4) Add food when the chime signals that the oven has reached preheat temperature.
- 5) If the temperature probe is used, follow temperature probe feature directions and USDA temperature recommendations on pages 26–27.
- 6) If the timer is set, the oven will chime when the cooking time is finished. If the timer is not cleared, it will continue to chime every 10 seconds.
- 7) Remove food. Always use dry pot holders when removing hot pans from the oven.
- 8) Touch oven OFF to end this mode.

## Broil Mode

In broil mode, the top heating element is used to produce an intense, radiant heat that browns one side of the food at a time.

Broiled foods usually must be turned over to brown the other side and finish cooking. The high heat cooks quickly and gives a rich, brown outer appearance. This mode is best for meats, fish and poultry pieces up to 1" (25) thick. The temperature probe cannot be used with this mode.

Refer to the Wolf cooking guide on pages 34–36. Use cooking times as a guide for similar foods.

### WOLF TIPS FOR SUCCESS

- Do not preheat for broil mode.
- Broil with oven door closed.
- Preferred for meat, fish and poultry pieces equal to or less than 1" (25) thick.
- Always use the two-piece broiler pan shipped with your oven. Always use slotted top grid of broiler pan. It allows fat to drip away from food and from intense radiant heat. This reduces spattering, smoking and risk of fire.
- Turn food halfway through cooking time.
- Brush lean meat and fish with peanut oil before cooking to prevent sticking.
- Start cooking poultry with skin side down.
- Begin with cold food directly from the refrigerator.

### SETTING CONTROLS

- 1) Place food in oven at the desired rack position. Close oven door.
- 2) Touch BROIL. For double ovens, this will turn on upper oven. To turn on lower oven, first touch the UPPER/LOWER touch pad so that the lower oven icon is selected in the control panel display. Then touch BROIL.
- 3) Oven temperature is preset at 1 for 550°F (290°C), high broil. Oven begins to broil after five seconds. To change setting, immediately touch number pad 2 for medium broil, 450°F (230°C) or 3 for low broil, 350°F (175°C).
- 4) Touch ENTER to start the cooking mode immediately.
- 5) If the timer is set, the oven will chime when the cooking time is finished. If the timer is not cleared, it will continue to chime every 10 seconds.
- 6) Remove food. Always use dry pot holders when removing hot pans from the oven.
- 7) Touch oven OFF to end this mode.

### ▲ CAUTION

When turning food or checking doneness, open the door carefully. Smoke and steam may have accumulated. Never use heatproof glass (e.g. Pyrex) or pottery. They can shatter.

## Convection Bake Mode

**IMPORTANT NOTE:** For double ovens, convection bake mode can only be used in the upper oven.

Convection bake mode combines heat from two convection elements with some heat from the bake element that is located beneath the oven floor. Two convection fans circulate this heat within the oven cavity. The added heat source from the bottom of the oven makes this mode ideal for pie baking. The temperature probe may be used in this mode.

Refer to the Wolf cooking guide on pages 34–36. Use cooking times as a guide for similar foods.

### WOLF TIPS FOR SUCCESS

- Always preheat for convection bake mode.
- Reduce standard recipe temperatures by 25° in this mode.
- Bake multiple pies on the same rack, rather than on different racks.
- This mode is ideal for single rack baking.

### SETTING CONTROLS

- 1) Touch  BAKE.
- 2) Oven temperature is preset at 375°F (190°C). Oven begins to heat after five seconds. To change oven temperature from 375°F (190°C), immediately enter another temperature using the number pads.
- 3) Touch ENTER to start the cooking mode immediately.
- 4) Add food when the chime signals that the oven has reached preheat temperature.
- 5) If the temperature probe is used, follow temperature probe feature directions on pages 26–27.
- 6) If the timer is set, the oven will chime when the cooking time is finished. If the timer is not cleared, it will continue to chime every 10 seconds.
- 7) Remove food. Always use dry pot holders when removing hot pans from the oven.
- 8) Touch oven OFF to end this mode.



## Convection Roast Mode

**IMPORTANT NOTE:** For double ovens, convection roast mode can only be used in the upper oven.

In convection roast mode, heat from both convection fans, with additional heat from the broil element, intensifies the convective and radiant heating. This combination gently browns the exterior and seals in juices, making it perfect for roasting tender cuts of beef, lamb, pork and poultry. The temperature probe may be used in this mode.

Refer to the Wolf cooking guide on pages 34–36. Use cooking times as a guide for similar foods.

### WOLF TIPS FOR SUCCESS

- Always preheat oven for convection roast mode.
- Use low-sided, uncovered pans on a roast rack to cook food.
- Reduce standard recipe temperatures by 25° in this mode.
- The lower part of the broiler pan with a meat rack makes an excellent roasting pan.
- Roasting time may be less than expected; check doneness earlier than usual.
- Select foods that are to be roasted uncovered.
- Begin with cold food directly from the refrigerator.
- Cook stuffed turkeys weighing over 15 lbs (6.8 kg) in Roast mode. Always cook stuffing to an internal temperature of 165°F (75°C).

### SETTING CONTROLS

- 1) Touch  ROAST. Oven temperature is preset at 325°F (165°C). Oven begins to heat after five seconds. To change oven temperature from 325°F (165°C), immediately enter another temperature using the number pads.
- 2) Touch ENTER to start the cooking mode immediately.
- 3) Add food when the chime signals that the oven has reached preheat temperature.
- 4) If the temperature probe is used, follow temperature probe feature directions and USDA temperature recommendations on pages 26–27.
- 5) If the timer is set, the oven will chime when the cooking time is finished. If the timer is not cleared, it will continue to chime every 10 seconds.
- 6) Remove food. Always use dry pot holders when removing hot pans from the oven.
- 7) Touch oven OFF to end this mode.

## Convection Broil Mode

**IMPORTANT NOTE:** For double ovens, convection broil mode can only be used in the upper oven.

In convection broil mode, intense radiant heat from the top element browns and sears the surface of the food while both convection fans circulate hot air around the food. This mode shortens broiling times for thicker cuts of meat, fish and poultry. The heat of the broiler browns the exterior, while the convection fans keep the interior moist and juicy. The temperature probe cannot be used with this mode.

Refer to the Wolf cooking guide on pages 34–36. Use cooking times as a guide for similar foods.

### WOLF TIPS FOR SUCCESS

- Do not preheat for convection broil mode.
- Convection broil with oven door closed.
- Preferred for meat, fish and poultry pieces thicker than 1" (25).
- Always use the two-piece broiler pan packaged with your oven. Always use slotted top grid of broiler pan. It allows fat to drip away from food and from intense radiant heat. This reduces spattering, smoking and risk of fire.
- Turn food halfway through cooking time.
- Brush lean meat and fish with peanut oil before cooking to prevent sticking.
- Start cooking poultry with skin side down.
- Begin with cold food directly from the refrigerator.

### SETTING CONTROLS

- 1) Place food in oven at the desired rack position. Close oven door.
- 2) Touch  BROIL. Oven temperature is preset at 1 for 550°F (290°C), high broil. Oven begins to broil after five seconds. To change setting, immediately touch number pad 2 for medium broil, 450°F (230°C) or 3 for low broil, 350°F (175°C).
- 3) Touch ENTER to start the cooking mode immediately.
- 4) If the timer is set, the oven will chime when the cooking time is finished. If the timer is not cleared, it will continue to chime every 10 seconds.
- 5) Remove food. Always use dry pot holders when removing hot pans from the oven.
- 6) Touch oven OFF to end this mode.

### CAUTION

When turning food or checking doneness, open the door carefully. Smoke and steam may have accumulated. Never use heatproof glass (e.g. Pyrex) or pottery. They can shatter.

## Convection Mode

**IMPORTANT NOTE:** For double ovens, convection mode can only be used in the upper oven.

In convection mode, dual convection fans, each with a heating element, operate from the back of the oven to move the heated air throughout the entire oven cavity. Uniform air movement makes it possible to multi-level rack cook in this mode. The heat is cycled on and off to maintain the temperature, resulting in evenly browned food. The temperature probe may be used in this mode.

Refer to the Wolf cooking guide on pages 34–36. Use cooking times as a guide for similar foods.

### WOLF TIPS FOR SUCCESS

- Always preheat for convection mode.
- Use low-sided, uncovered pans to cook foods.
- A 14" (356) x 16" (406) baking sheet is an optimum size. Allow at least 1" (25) between edge of pan and walls of oven.
- Reduce standard recipe temperatures by 25° in this mode.
- Pans do not need to be staggered when cooking on more than one rack.
- Baking time may be less than expected; check doneness 5 to 10 minutes early.

### SETTING CONTROLS

- 1) Touch  CONV.
- 2) Oven temperature is preset at 325°F (165°C). Oven begins to heat after five seconds. To change oven temperature from 325°F (165°C), immediately enter another temperature using the number pads.
- 3) Touch ENTER to start the cooking mode immediately.
- 4) Add food when the chime signals that the oven has reached preheat temperature.
- 5) If the temperature probe is used, follow temperature probe feature directions on pages 26–27.
- 6) If the timer is set, the oven will chime when the cooking time is finished. If the timer is not cleared, it will continue to chime every 10 seconds.
- 7) Remove food. Always use dry pot holders when removing hot pans from the oven.
- 8) Touch oven OFF to end this mode.

## Proof Mode

In proof mode, a combination of broil and bake elements are used to heat and balance the air to maintain temperature. This mode is ideal for proofing, or rising bread dough.

### WOLF TIPS FOR SUCCESS

- No need to preheat for proof mode.
- Proof bread until dough has doubled in bulk.
- For best results, place a shallow pan with 1 to 3 cups (.2-.7 L) boiling hot water on rack position 1 to keep the air moist inside the oven cavity.
- The oven does not allow the temperature to be set above 110°F (45°C) in proof mode. If the oven is too hot, the oven door should be opened to allow the oven to cool down below 120°F (50°C) to prevent destroying the yeast.
- Allow at least 1" (25) between edge of pan and walls of oven.
- Limit frequent door openings to prevent losing heat and lengthening proofing time.

### ⚠ CAUTION

Do not place cookware on oven floor or use aluminum foil or other material to line the oven floor or side walls. Failure to adhere to this notice will damage the porcelain and will void your warranty.

### SETTING CONTROLS

- 1) Place dough in oven-safe dish in oven.
- 2) Touch PROOF.
- 3) Oven temperature is preset to 85°F (30°C). Touch ENTER on the control panel. To change the temperature from 85°F (30°C), immediately touch another temperature using the number pads. The maximum temperature in proof mode is 110°F (45°C).
- 4) If the timer is set, the oven will chime when the cooking time is finished. If the timer is not cleared, it will continue to chime every 10 seconds.
- 5) Remove food. Always use dry pot holders when removing hot pans from the oven.
- 6) Touch oven OFF to end this mode.



## Bake Stone Mode

A specially designed rack and bake stone are used for bake stone mode to assure the food quality expected from this specific form of cooking. To produce a hot oven environment necessary for baking on a ceramic stone, the heat from all elements creates the perfect “brick oven” effect. Both convection fans help circulate the air throughout the oven cavity, so even temperatures are achieved. The temperature probe may be used in this mode.

To prepare the oven, remove all oven racks. Slide the bake stone rack onto rack guide position 1 and place the bake stone on the rack with the lip hanging over front edge of rack. Refer to the illustration below. Preheat the oven for approximately 35 minutes when using bake stone mode.

**IMPORTANT NOTE:** Use care in handling the bake stone. It will chip or break if dropped.

Refer to the Wolf cooking guide on pages 34–36. Use cooking times as a guide for similar foods.

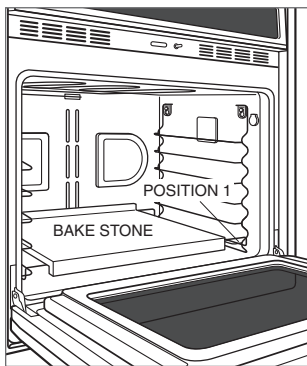

Bake stone placement.

### WOLF TIPS FOR SUCCESS

- Always preheat for bake stone mode after positioning the oven rack and ceramic stone. Allow approximately 35 minutes for this function to reach the set oven temperature. For best results, preheat oven for one hour before adding food.
- During preheat, convection fans and all elements are used to quickly and uniformly heat the oven.
- Use only the Wolf bake stone in bake stone mode.
- Use only one bake stone rack per oven.
- Food is usually cooked directly on the stone. To prevent sticking, apply plenty of cornmeal or flour to the bottom of the food.
- When baking a series of breads or pizzas in a row, allow 5 minutes between foods for the bake stone to return to the proper temperature.
- Bake stone and rack should be removed after baking and not left in oven during any of the other cooking modes.

### ⚠ CAUTION

Avoid cooking foods with a high fat content on the bake stone. The porous ceramic material will absorb grease and discolor the stone. Flare-ups can occur.

## Bake Stone Mode

### SETTING CONTROLS

- 1) Touch STONE.
- 2) Oven temperature is preset at 400°F (205°C). Oven begins to heat after five seconds. To change oven temperature from 400°F (205°C), immediately enter another temperature using the number pads.
- 3) Touch ENTER to start the cooking mode immediately.
- 4) Add food when the chime signals that the oven has reached preheat temperature.
- 5) If the temperature probe is used, follow temperature probe feature directions on pages 26–27.
- 6) If the timer is set, the oven will chime when the cooking time is finished. If the timer is not cleared, it will continue to chime every 10 seconds.
- 7) Remove food. Always use dry pot holders when removing hot pans from the oven.
- 8) Touch oven OFF to end this mode.

### BAKE STONE ACCESSORY

The bake stone accessory is available through your authorized Wolf dealer. For local dealer information, visit the find a showroom section of our website, [wolfappliance.com](http://wolfappliance.com). Additional use & care information is provided with the bake stone accessory.

### BAKE STONE CARE

Remove excessive food using a scraper. Brush off any crumbs. Allow the stone to cool completely before wiping with a wet cloth. Wet cloths on a hot surface can cause steam burns. Do not soak or immerse the bake stone in water and do not use soap or detergent. The ceramic stone could absorb the taste and transmit those flavors to the food.

Stubborn stains may occur on the bake stone. These will not impair the flavor of the food being baked.

Allow the bake stone to cool completely before removing from oven.

**IMPORTANT NOTE:** Use care in handling the bake stone. It will chip or break if dropped.

#### **⚠ CAUTION**

Allow the bake stone to cool completely before wiping with a wet cloth. Wet cloths on a hot surface can cause steam burns.

## Dehydration Mode

**IMPORTANT NOTE:** For double ovens, dehydration mode can only be used in the upper oven.

Dehydration mode allows for slowly drying out food for preservation and other cooking uses. Wolf accessory dehydration racks (not included with the oven) are required. This mode is suitable for drying a variety of fruits, vegetables, herbs and meat strips. Refer to the dehydration guide on the following page.

**IMPORTANT NOTE:** As a safety feature, the E series oven will shut off after 12 hours. Dehydration mode overrides the 12-hour shut off.

### DEHYDRATION ACCESSORY

Dehydration racks are available through your authorized Wolf dealer. For local dealer information, visit the find a showroom section of our website, [wolfappliance.com](http://wolfappliance.com). Additional instructions are provided with the dehydration rack accessory.

### WOLF TIPS FOR SUCCESS

- Do not preheat when using dehydration mode.
- Multiple racks can be used simultaneously.
- Some foods require as many as 14 to 15 hours to fully dehydrate.
- Consult a food preservation book for specific times and handling of various foods.

### SETTING CONTROLS

- 1) Place food in oven on dehydration racks.
- 2) Place door stop (supplied with accessory package) in the proper position to keep oven door open. Refer to instructions provided with the accessory kit.
- 3) Touch DEHYD.
- 4) Oven preset temperature is 135°F (60°C). To change the temperature setting, immediately touch another temperature, 110°F (45°C) to 160°F (70°C), using the number pads.
- 5) Leave food in the oven until completely dry to the touch.
- 6) Remove food from racks before completely cool for easy removal. If excessive sticking occurs, place dehydration trays back in the oven to warm slightly for easier removal.
- 7) Touch oven OFF to end this mode.

## Dehydration Mode

### DEHYDRATION GUIDE

The following is a list of foods commonly dehydrated. Use dehydration times as a guide for similar foods. Place food on dehydration racks with no overlapping. Oven preset temperature for dehydration is 135°F (60°C).

- **Apples**  
Slice 1/4" (6) thick. Remove seeds and stems.  
Dehydrate 6–7 hours.
- **Bananas**  
Slice 1/4" (6) thick. Dehydrate 12–13 hours.
- **Green Bell Peppers**  
Wash, seed and stem. Slice 1/4" (6) thick or into 1" (25) x 2" (51) chunks. Dehydrate 14–15 hours.
- **Tomato Slices**  
Wash, seed and stem. Slice 1/4" (6) thick. Dehydrate 6–7 hours.
- **Tomato Chunks**  
Wash, seed and stem. Cut each tomato into 16 equal pieces. Dehydrate 12–13 hours.

### ⚠ CAUTION

Foods must be dried to below .60 water activity or dry to the touch to be safely stored with no danger of mold, yeasts or bacteria growing. When in doubt, dehydrate for the maximum time specified.



## Delayed Start Feature

Delayed start feature controls the automatic timing of the oven's ON and OFF function. Set a mode to start later in the day and shut off when the cooking is complete or set it to shut off at a preset time. Use in combination with any cooking mode except broil, convection broil and bake stone.

### WOLF TIPS FOR SUCCESS

- Ovens can be set independently.
- Do not delay the start when preheating is critical to the cooking results.
- When using the delayed start feature, place food directly from the refrigerator into the oven.
- The time-of-day clock must display the correct time prior to programming a timed activity.

### FOOD SAFETY GUIDELINES

#### WARNING

Food safety is important. Adhere to the following guidelines to avoid potential illness or spoilage of food:

- Perishable food should not be left out more than 2 hours at room temperature; 1 hour when the temperature is above 90°F (30°C). For more information, see [www.usda.com](http://www.usda.com).
- Avoid using foods that will spoil before the cooking cycle begins. These include eggs, dairy products, cream soups, cooked and uncooked meats, poultry and fish.
- If cooking will not begin immediately, place only very cold or frozen food into the oven.

### SETTING CONTROLS

- 1) Touch cooking mode (except BROIL, CONVECTION BROIL and BAKE STONE). For double ovens, this will turn on upper oven. To turn on lower oven, first touch the UPPER/LOWER touch pad so that the lower oven icon is selected in the control panel display. Then touch desired mode. Note that some cooking modes are not available for lower oven. Change preset temperature if needed.
- 2) Touch TIMED COOK. Use the number pads to set the number of hours/minutes the oven will stay on (COOK DURATION). Example: Set 3:30 for the oven to remain on for 3<sup>1</sup>/<sub>2</sub> hours.
- 3) When prompted, use the number pads to set the time of day the oven will shut off (STOP TIME), then touch ENTER. Example: Set 6:00 for the time of day the oven turns off.
- 4) Next, touch 1 for am or 2 for pm, then touch ENTER. The display appears as if the oven is on. Using the example above, heating will start at 3<sup>1</sup>/<sub>2</sub> hours prior to six o'clock which will be 2:30 on the time-of-day clock.
- 5) One audible chime will sound when the cooking time is complete. If the timer is not cleared, it will continue to chime every 10 seconds.
- 6) The oven will shut off after the STOP TIME has been reached.
- 7) Remove food. Always use dry pot holders when removing hot pans from the oven.
- 8) Touch oven OFF to clear the display and stop the signal.

## Temperature Probe Feature

**IMPORTANT NOTE:** For double ovens, temperature probe feature can only be used in the upper oven.

The temperature probe measures doneness by measuring the internal temperature of food without opening the oven door. It is a convenient and accurate way to achieve the perfect doneness regardless of the type, cut or weight of the food. Calculating a total cooking time by weight is no longer necessary using this feature. Use with all modes except broil and convection broil modes.

**IMPORTANT NOTE:** The accuracy of the probe is decreased for all temperatures below 100°F (40°C). Food taken directly from the refrigerator could display the incorrect temperature until it has reached 100°F (40°C).

### WOLF TIPS FOR SUCCESS

- Insert sensor into the thickest part of meat before placing in oven.
- To determine the center, hold sensor outside of the meat with point at center of cut. Mark length of insertion by placing your fingers on sensor at top of meat. Move sensor to thickest part of meat and insert up to your fingers.
- Standing time refers to the 10- to 15-minute time period the meat rests before being carved. This helps more juices to be retained in the meat.
- For poultry, insert probe into the thickest part of the thigh.
- Use aluminum foil to cover meat during the standing time to help keep it hot before carving.
- Wash probe by hand; do not soak or clean in the dishwasher.

### INTERNAL TEMPERATURE

The internal temperatures shown in the chart below are USDA recommended carving temperatures.

### INTERNAL TEMPERATURE

DONENESS	INTERNAL TEMP
<b>BEEF, LAMB AND VEAL</b>	
Rare	140°F (60°C)
Medium Rare	145°F (65°C)
Medium	160°F (70°C)
Well Done	170°F (75°C)
<b>PORK</b>	
Well Done	170°F (75°C)
<b>POULTRY</b>	
Well Done Breast	170°F (75°C)
Well Done Thigh	180°F (80°C)
Well Done Stuffing	165°F (75°C)

## Temperature Probe Feature

### SETTING CONTROLS FOR MEATS

- 1) Preheat oven to desired oven temperature in desired mode.
- 2) Place meat on a rack in the roasting pan. Insert the probe sensor into the thickest part of the meat as described in tips for success on the previous page.
- 3) When the oven signals that preheat is completed, use a dry pot holder to lift the probe sensor cover. Slide the probe connector into the receptacle on the wall of the oven until it snaps into place. Close the oven door.
- 4) Touch TEMP PROBE. Touch number pads for the carving temperature of the meat. It is recommended to allow meat to rest before carving.
- 5) Touch ENTER. If ENTER is not touched, the oven will automatically start the temperature probe feature in 8 seconds. The control panel display shows the oven temperature and the rising probe temperature counting up to the doneness setting.
- 6) When the carving temperature is reached, two chimes will signal. Remove probe from the oven receptacle. The chime continues every 10 seconds until the probe is unplugged or until you touch CLEAR.
- 7) To end this feature and turn the oven off, touch oven OFF.

**IMPORTANT NOTE:** If the probe connector is not fully seated into the probe receptacle, you will hear an audible signal, and 'PROBE SHORTED' will show in the control panel display. Refer to the troubleshooting guide on page 37.

### SETTING CONTROLS FOR BREADS

- 1) Preheat oven to desired oven temperature in bake or bake stone mode.
- 2) Place bread on bake stone or in oven in bread pans.
- 3) Bake 10 minutes at the desired oven temperature.
- 4) Insert probe sensor into the thickest part of the bread.
- 5) Using a dry pot holder, lift the probe sensor cover. Slide the probe connector into the receptacle on the wall of the oven until it snaps into place. Close the oven door.
- 6) Touch TEMP PROBE. Touch number pads for the end internal baking temperature 195°F (90°C) to 210°F (100°C).
- 7) Touch ENTER. The control panel display shows the oven temperature and the rising probe temperature counting up to the doneness setting.
- 8) When the carving temperature is reached, two chimes will signal. Remove probe from the oven receptacle. The chime continues every 10 seconds until the probe is unplugged or until you touch CLEAR.
- 9) To end this feature and turn the oven off, touch oven OFF.

#### **▲ CAUTION**

**Probe and probe sensor cover become very hot.  
Handle with a dry pot holder.**

## Timed Cook Feature

Timed cook feature allows the oven to shut off automatically when cooking is complete. Use in combination with any cooking mode except broil, convection broil and bake stone.

### SETTING CONTROLS

- 1) Touch cooking mode, such as BAKE. Change preset temperature if needed.  
  
For double ovens, this will turn on upper oven. To turn on lower oven, first touch the UPPER/LOWER touch pad so that the lower oven icon is selected in the control panel display. Then touch desired mode.
- 2) Touch TIMED COOK. Use the number pads to set the number of hours/minutes the oven is to stay on.
- 3) Touch ENTER. Oven begins to heat after five seconds. Stop time will automatically be added to the display. At the end of cook time, oven turns off.
- 4) Touch oven OFF or CLEAR to clear the display.

## Sabbath Feature

### STAR-K CERTIFIED

Sabbath feature allows for baking or keeping food warm while adhering to the “no work” requirements on religious Sabbath days. It provides an unchanging heat source for an uninterrupted extended period of time. Once the oven reaches its desired temperature, it does not change. Use this feature only in the bake and roast modes.

While in Sabbath mode, the oven will stay on indefinitely until manually turned off. Oven temperature may be adjusted, but the display will remain unchanged. Lights stay either on or off, all chimes are turned off and heating cycles are not interrupted by opening the door.

For double ovens, ovens can be set independently, though both ovens will be set in Sabbath feature. Each oven can have options individually set such as temperature and lights.

**IMPORTANT NOTE:** As a safety feature, the E series oven will shut off after 12 hours. Sabbath feature overrides the 12-hour shut off.

**IMPORTANT NOTE:** After a power outage, the oven will not return to the Sabbath feature settings.

## Sabbath Feature

### SETTING CONTROLS

- 1) Touch OVEN LIGHT, turning on the lights in one or both ovens (optional).
- 2) Touch BAKE or ROAST. Oven is preset at 350°F (175°C). To change oven temperature, immediately enter another temperature using number pads.
- 3) Touch ENTER. If preferred, repeat the above steps with other oven.
- 4) Touch and hold ENTER for five seconds to set to Sabbath. 'SABBATH' appears in the control panel display.
- 5) Touch oven OFF to end this feature. Oven remains on until this feature is cancelled.

**EXAMPLE:** To set Sabbath feature in a double oven with upper oven in roast mode set at 240°F (115°C) and lower oven in bake mode set at 200°F (95°C).

- To set upper oven: Touch ROAST. Enter 2-4-0 using the number pads. Touch ENTER.
- To set lower oven: Touch the UPPER/LOWER touch pad to select the lower oven. Touch BAKE. Enter 2-0-0 using the number pads. Touch ENTER.
- Touch and hold ENTER for five seconds to enter Sabbath feature.
- Touch single or double oven OFF to end this feature. Oven(s) remain on until the feature is cancelled.

### SETTING CONTROLS FOR TIMED COOK

- 1) Add food to the oven.
- 2) Touch oven ON.
- 3) Touch BAKE or ROAST. Oven is preset at 350°F (175°C). To change oven temperature, immediately enter another temperature using number pads.
- 4) Touch TIMED COOK. Use the number pads to set the number of hours/minutes the oven will stay on. Example: Set 3:30 for the oven to remain on for 3<sup>1</sup>/<sub>2</sub> hours.
- 5) Touch STOP TIME. Use the number pads to set the time of day the oven will shut off.
- 6) Touch OVEN LIGHT on or off as desired.
- 7) Touch and hold ENTER for five seconds. 'SABBATH' will appear in the control panel display.
- 8) When the food is finished, remove the food. Oven remains unable to be reset until the Sabbath feature is ended.
- 9) After the Sabbath or holiday is over, touch oven OFF to end this feature.



## Self-Clean Feature

With the self-clean feature, the oven is heated in graduated steps to a high preset temperature. During this process, food soil is burned off, leaving some white ash residue. For safety, the oven door automatically locks during self-clean and unlocks when the oven has cooled to below 300°F (150°C). If you stop the self-clean cycle before completion, the door will remain locked until the oven has cooled sufficiently. Oven lights are deactivated during self-clean.

Set in combination with delayed start feature, the self-clean feature can be programmed to start at a later time. Refer to delayed start feature on page 25.

**IMPORTANT NOTE:** For a double oven, the self-clean feature may be used in only one oven at a time and the other oven cannot be used for cooking.

**IMPORTANT NOTE:** Before using the self-clean feature, remove all oven racks and rack guides. They will discolor if left in the oven during self-clean. Refer to oven racks on page 12.

**IMPORTANT NOTE:** Never use oven cleaners. They are not necessary with the self-clean feature.

You may hear a popping or crackling sound during the self-clean cycle. These sounds are normal and are caused by the expansion and contraction of metal surfaces as they heat up and cool down. It is also normal to see a brief flame-up, depending on the amount and content of the soil.

**IMPORTANT NOTE:** A small amount of smoke and odor may be noticed during the first self-clean cycle, as residual oil and grease used during the manufacturing process is burned off.

### ⚠ CAUTION

Do not use commercial oven cleaners or oven liner protective coatings on or around any part of the oven.

### ⚠ CAUTION

The oven gasket is important for a good seal. Do not hand clean, rub, puncture or remove this gasket.

### ⚠ CAUTION

Never wipe a warm or hot porcelain surface with a damp sponge. It may cause chipping or crazing (tiny hairlike lines).

## Self-Clean Feature

### WOLF TIPS FOR SUCCESS

- Before using the self-clean feature, remove the oven racks and rack guides. They will discolor if left in the oven during self-clean.
- Remove broiler pan and any other utensil stored inside the oven.
- Remove any food particles and grease from spillovers before starting self-clean.
- Food with high sugar or acid content, such as fruit juice, milk and tomatoes, may cause a permanent dull spot. Wipe up immediately or remove with a razor blade scraper before using the self-clean feature.
- Use the self-clean feature as often as necessary. Do not wait until heavy soil accumulates.
- After the self-clean cycle is complete and the oven has cooled, use a damp sponge or paper towel to wipe up any ash.

### SETTING CONTROLS

- 1) Remove all oven racks and rack guides before self-cleaning.
- 2) Touch CLEAN. For double ovens, this will start self-clean for upper oven. To self-clean lower oven, first touch the UPPER/LOWER touch pad so that the lower oven icon is selected in the control panel display. Then touch CLEAN. The control panel will automatically scroll the following message: REMOVE ALL RACKS AND RACK GUIDES. PRESS ENTER.
- 3) Touch ENTER to start the default clean for a total time of 3 hours; self-clean for 2 hours and cool down for 1 hour.
- 4) The cleaning time can be adjusted to any amount of time between 2<sup>1</sup>/<sub>2</sub> and 4 hours. Touch TIMED COOK, then enter the clean time. For best results, the cleaning time should be set at 4 hours.
- 5) Enter the desired stop time and touch ENTER. The oven will automatically start and stop based on the desired cleaning time and stop time.
- 6) Touch desired oven OFF to clear the display when oven is finished cleaning.

### **▲ WARNING**

During self-clean, exterior surfaces may get hotter than usual. Children should be kept away.

## Light Bulb Replacement

### ⚠ WARNING

Shut off electrical power to the oven before replacing light bulb.

**IMPORTANT NOTE:** Allow the oven to cool sufficiently before replacing the light bulb.

The oven uses a 20-watt halogen light bulb. Oven rack guides must be removed to access the light bulb. Refer to page 12.

To remove the light cover, place a hot pad against the oven wall, press a screwdriver against the hot pad and under the edge of the light cover. Gently pry the edge of the light cover up and away from the wall. Be careful not to scratch the porcelain oven interior. Use a paper towel to handle the light bulb and remove it from the socket.

Avoid direct contact with the replacement bulb. Handle with a paper towel to keep oil from fingers off the bulb, or the bulb will burn out at first use. To replace the light bulb, insert the bulb prongs into the socket until it snaps into place. Replace the light cover and oven rack guides. Turn on electrical power and reset the time-of-day clock.

### ⚠ CAUTION

Use caution when handling light bulbs. Halogen bulbs get hot instantly and adjacent parts may retain heat.

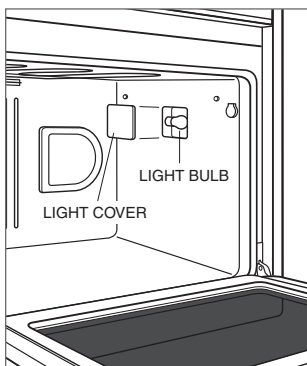

Light bulb replacement.

## Bakeware Selection

For best results, we recommend medium- to heavy-weight bakeware. Use the following guidelines when selecting bakeware:

- A 14" (356) x 16" (406) baking sheet is an optimum size for the ovens. Allow at least 1" (25) between edge of pan and walls of oven.
- Size, shape and finish of bakeware affects the baking time. Food on insulated bakeware cooks more slowly. Food cooked in dark metal pans may cook faster than food cooked in shiny pans.
- Dark, nonstick pan coatings brown more than light, nonstick coatings.

## Care Recommendations

### Oven exterior, handle and trim.

- Do not use abrasive cleaners; they will permanently scratch the surface.
- Stainless steel exterior: Use a soft, nonabrasive stainless steel cleaner like Signature polish and apply with a soft, lint-free cloth. To bring out the natural luster, lightly wipe the surface with a water-dampened microfiber cloth, followed with a dry microfiber cloth. All work should follow the grain direction of the finish. Best results are obtained by keeping the cloth in continuous contact with the metal. Signature polish is available from Signature Limited Laboratory, P. O. Box 13436, Dayton, Ohio 45413, 877-376-5474.
- Black glass exterior: Spray glass cleaner on a soft cloth to clean.

### Oven cavity and door interior (porcelain enamel).

- Never wipe a warm or hot porcelain surface with a damp sponge; it may cause chipping or crazing (tiny hairlike cracks).
- General care: When cool, clean splatters and spills immediately. Do not allow food with a high sugar or acid content, such as milk, tomatoes, sauerkraut, fruit juices or pie filling, to remain on any porcelain enamel surface. Failure to remove these foods may cause a permanent dull spot. When hand cleaning a spot, use only non-abrasive cleaners or scrubbers.
- Self-clean feature can be used.

### Oven door window (heat-tempered glass).

- When the window is cool, use a razor blade to gently lift baked-on foods with a multi-surface spray cleaner.

### Oven light cover (heat-tempered glass).

- When the oven is cool, follow instructions on page 32 to remove oven light cover. Wash with mild abrasive cleaner. Rinse and dry thoroughly. Replace oven light cover. A 20-watt halogen oven light bulb replaces the existing bulb.

### Oven racks and rack guides (nickel-plated steel).

- Before using the self-clean feature, remove oven racks and rack guides. They will discolor if left in the oven during self-clean. Clean with steel wool soap pad and hot water. Rinse and dry.

### Oven gasket (fiberglass netting and wire).

- Do not hand clean, rub, puncture or remove the oven gasket; this may compromise the tight door seal.

### Broiler pan (porcelain enamel).

- Top: While slightly warm, place in the sink and lay dish towels on top. Pour very hot water on the towels and allow steam to soften cooked-on residue. Clean with hot water and a mild detergent. Rinse and dry.
- Bottom: Pour grease into a disposable can. When cool, wash in hot water and a mild detergent. Rinse and dry.

### Bake stone (ceramic).

- Use care in handling the bake stone. It will chip or break if dropped. Do not soak or immerse the bake stone in water and do not use soap or detergent. Refer to bake stone care on page 22.

### Control panel (polycarbonate plastic).

- Do not use abrasive cleaners, steel-wool pads, gritty washcloths or some paper towels. Damage may occur.
- Use glass cleaners or all-purpose cleaners (without oil) with soft cloth or sponge. Apply cleaner to soft cloth or sponge, not directly to the panel.

## Cooking Guide

## BAKED GOODS

FOOD	COOKING MODE	OVEN TEMPERATURE	RACK POSITION	COOKING TIME
<b>BREAD</b>				
<b>Biscuits*</b> (multiple trays)	Bake	450°F (230°C)	4	8–10 min
	Convection	425°F (220°C)	2 and 5 or 2, 4 and 6	8–10 min
<b>Cinnamon rolls</b> (multiple trays)	Bake	350°F (175°C)	4	20–25 min
	Convection	325°F (165°C)	2 and 5	20–25 min
<b>Rolls</b> (multiple trays)	Bake	350°F (175°C)	4	20–25 min
	Convection	325°F (165°C)	2 and 5	15–20 min
<b>Yeast bread**</b>	Convection	325°F (165°C)	4	25–30 min
<b>Yeast loaf**</b>	Bake Stone	400°F (205°C)	1	10–15 min
<b>Cornbread</b>	Convection	375°F (190°C)	4	20–25 min
<b>Quick breads</b> (single or multiple)	Convection	325°F (165°C)	3 or 2 and 5	40–45 min
<b>CAKES</b>				
<b>Angel food</b>	Bake	350°F (175°C)	2	37–45 min
<b>Bundt</b>	Convection	325°F (165°C)	4	40–45 min
<b>Mixes</b> (multiple)	Bake	350°F (175°C)	4	30–40 min
	Convection	325°F (165°C)	2 and 5	25–30 min
<b>Cupcakes</b> (multiple trays)	Bake	350°F (175°C)	4	20–25 min
	Convection	325°F (165°C)	2 and 5	18–23 min
<b>COOKIES</b>				
<b>Brownies</b> (multiple trays)	Bake	350°F (175°C)	4	20–25 min
	Convection	325°F (165°C)	2 and 5	15–20 min
<b>Sugar</b> (multiple trays)	Bake	350°F (175°C)	4	8–12 min
	Convection	325°F (165°C)	2 and 5 or 2, 4 and 6	8–12 min
<b>Chocolate chip</b> (multiple trays)	Bake	375°F (190°C)	4	8–12 min
	Convection	350°F (175°C)	2 and 5 or 2, 4 and 6	8–9 min
<b>MUFFINS</b>				
<b>Muffins</b> (single tray) (multiple trays)	Bake	400°F (205°C)	4	15–20 min
	Convection	375°F (190°C)	4	10–15 min
	Convection	375°F (190°C)	2 and 5	10–15 min
<b>PIES</b>				
<b>Filled</b>	Conv Bake	375°F (190°C)	4	40–45 min
<b>Frozen</b>	Conv Bake	375°F (190°C)	4	50–55 min
<b>Lemon meringue</b>	Broil	Low (3)	4	21/2 min
<b>Pumpkin</b>	Conv Bake	425°F (220°C) / 325°F (165°C)	4	15 min / 1 hr
<b>Pastry crust</b>	Conv Bake	425°F (220°C)	4	10–12 min
<b>OTHER</b>				
<b>Popovers</b> (single tray) (multiple trays)	Bake	450°F (230°C) / 350°F (175°C)	4	15 min / 20 min
	Convection	450°F (230°C) / 350°F (175°C)	2 and 5	15 min / 20 min
<b>Puff pastry</b> (single or multiple)	Bake	400°F (205°C)	4	10–12 min
	Convection	375°F (190°C)	4 or 2, 4 and 6	10–12 min
<b>Cream puffs</b>	Convection	400°F (205°C)	4 or 2, 4 and 6	30–35 min
<b>Custard and Pudding</b>	Bake	350°F (175°C)	4	35–40 min

\*For refrigerated biscuits, follow package directions. \*\*Internal temperature of 195–200°F (90–95°C). This chart is a guide; recipe or package directions should take precedence.

## Cooking Guide

## MEATS

FOOD	COOKING MODE	OVEN TEMP	RACK	COOKING TIME	INTERNAL TEMP
<b>BEEF</b>					
Chuck roast, 2–4 lbs (.9–1.8 kg)	Conv Roast	325°F (165°C)	3	20–25 min/lb	Med 160°F (70°C)
Ground, patties	Broil	High (1)	6	10–12 min	Med 150°F (65°C)
Rib roast, 4–6 lbs (1.8–2.7 kg)	Conv Roast	325°F (165°C)	3	25–30 min/lb	Rare 140°F (60°C)
Sirloin rump roast, 4–6 lbs (1.8–2.7 kg)	Conv Roast	325°F (165°C)	3	30–35 min/lb	Rare 140°F (60°C)
Sirloin tip roast, 3–5 lbs (1.3–2.3 kg)	Conv Roast	325°F (165°C)	3	30–35 min/lb	Rare 140°F (60°C)
Steaks, 1½" (38) thick	Conv Broil	High (1)	5	20–25 min	Rare 140°F (60°C)
Steaks, 1" (25) thick	Broil	High (1)	5	12–15 min	Rare 140°F (60°C)
Tenderloin, 2–3 lbs (.9–1.3 kg)	Conv Roast	325°F (165°C)	3	20–25 min/lb	Rare 140°F (60°C)
<b>POULTRY</b>					
Chicken, bone-in breasts	Conv Broil	Med (2)	5	20–25 min	Well 170°F (75°C)
Chicken, boneless breasts	Broil	Med (2)	6	10–15 min	Well 170°F (75°C)
Chicken, quarters	Conv Broil	Med (2)	5	30–35 min	180°F (80°C) in thigh
Chicken, thighs	Conv Broil	Med (2)	5	20–25 min	Well 180°F (80°C)
Chicken, whole	Conv Roast	325°F (165°C)	3	18–20 min/lb	180°F (80°C) in thigh
Turkey breast, whole	Conv Roast	300°F (150°C)	2	12–15 min/lb	170°F (75°C) in breast
Turkey, pieces	Conv Broil	Med (2)	4	40–45 min	180°F (80°C) in thigh
Turkey, whole	Conv Roast	325°F (165°C)	1	11–14 min/lb	180°F (80°C) in thigh
Cornish game hens	Conv Roast	325°F (165°C)	3	28–33 min	180°F (80°C) in thigh
Cornish game hens	Roast	350°F (175°C)	3	28–33 min	180°F (80°C) in thigh
Duck, 5–7 lbs (2.3–3.2 kg)	Conv Roast	325°F (165°C)	3	18–20 min/lb	180°F (80°C) in thigh
Goose, 8–10 lbs (3.6–4.5 kg)	Conv Roast	325°F (165°C)	2	18–20 min/lb	180°F (80°C) in thigh
<b>PORK</b>					
Chops, 1" (25) thick	Broil	Med (2)	6	10–15 min	Med 160°F (70°C)
Loin, 3–4 lbs (1.3–1.8 kg)	Conv Roast	325°F (165°C)	3	18–22 min/lb	Med 160°F (70°C)
Steak, 1" (25) thick	Broil	Med (2)	5	25–30 min	Med 160°F (70°C)
Ham, ½" (13) thick	Broil	High (1)	6	6–8 min	140°F (60°C)
Ham, 1" (25) thick	Broil	High (1)	6	10–12 min	140°F (60°C)
<b>LAMB</b>					
Chops, ¾" (19) thick	Broil	High (1)	5	8–10 min	Med Rare 145°F (65°C)
Chops, ¾" (19) thick	Broil	High (1)	5	11–12 min	Med 160°F (70°C)
Leg, 4–6 lbs (1.8–2.7 kg)	Conv Roast	325°F (165°C)	3	20–25 min/lb	Med Rare 145°F (65°C)
Crown rack	Conv Roast	325°F (165°C)	1	15–18 min/lb	Med Rare 145°F (65°C)
<b>OTHER</b>					
Veal roast, 2–3 lbs (.9–1.4 kg)	Conv Roast	300°F (150°C)	3	30–35 min/lb	Med Rare 140°F (60°C)
Meat loaf	Conv Roast	325°F (165°C)	3	50–60 min	160°F (70°C)
Sausage	Broil	Med (2)	5	8–10 min	Med 160°F (70°C)

\*Min/lb indicates specified cook time per pound or .45 kg. Probe cannot be used in broil or convection broil modes, use a meat thermometer to check internal temperature. This chart is a guide; recipe or package directions should take precedence.



## Cooking Guide

### ENTREES AND MISC

FOOD	COOKING MODE	OVEN TEMPERATURE	RACK POSITION	COOKING TIME
<b>ENTREES</b>				
Calzone	Bake Stone	400°F (205°C)	1	9–10 min
Quiche	Bake (convection not advised)	375°F (190°C)	4	40–50 min
Soufflé	Bake	375°F (190°C)	4	35–40 min
<b>PIZZA</b>				
Frozen	Bake Stone	400°F (205°C)	1	8–14 min
Homemade	Bake Stone	450°F (230°C)	1	10–13 min
<b>SEAFOOD</b>				
Fillet, 1/2" (13) thick	Broil	Med (2)	6	5–7 min
Fillet, 1" (25) thick	Conv Broil	Med (2)	6	12–17 min
Red snapper	Broil	Med (2)	6	5–7 min
Salmon, 1/2" (13) thick	Broil	Med (2)	6	12–15 min
Swordfish, 1 1/2" (38) thick	Broil	Med (2)	6	10–12 min
<b>VEGETABLES</b>				
Potatoes	Bake	400°F (205°C)	3	45–60 min
Sweet potatoes	Bake	400°F (205°C)	3	40–50 min
Winter squash	Convection	350°F (175°C)	3	40–45 min
Winter squash	Bake	375°F (190°C)	3	50–55 min
<b>OTHER</b>				
Baked Alaska	Broil	Low (3)	4	5–7 min
French bread pizza	Broil	Med (2)	5	2–3 min
Garlic bread, 1" (25) thick	Broil or Conv Broil	Med (2)	5	3–3 1/2 min
Toast, 1/2" (13) thick	Broil	Med (2)	6	2 min

Probe cannot be used in broil or convection broil modes, use a meat thermometer to check internal temperature. This chart is a guide; recipe or package directions should take precedence.

## Troubleshooting

If your Wolf E series oven is not operating properly, use the following troubleshooting guide before calling Wolf factory certified service. This guide will save you time and trouble and may help you avoid the expense of a service call.

### Oven door not closing properly.

- Oven racks or rack guides not installed properly.

### Exterior browning is uneven.

- Pan is too large for good heat circulation or too many pans on a rack.
- Rack covered with aluminum foil, trapping heat below.

### Oven temperature is too hot.

- Food cooked in glass, glass ceramic, or dark metal which holds more heat than shiny pans.
- Oven temperature setting is too high or baking pan too large for recipe.
- Change rack level or cooking mode.

### Oven temperature is not hot enough.

- Oven is not fully preheated.
- Door opened too often or left open too long.
- Food wrapped in foil; check mode for tips that give best results.
- Pan is too small for recipe.

### Excessive smoke when broiling.

- Pan other than two-piece broiler pan is being used.
- Failure to trim off extra fat.
- Lower rack level or shorten time.

### Warm air venting into kitchen after oven has been turned off.

- Warm air exhaust is a normal function and is necessary to maintain and cool down oven temperatures. It turns off automatically when oven cools sufficiently.

### PROBE SHORTED flashes when using probe feature.

- Touch oven OFF. Push probe into probe receptacle completely until it snaps into place. Reset oven temperature and probe temperature.

## Service Information

When requesting information, literature, replacement parts or service, always refer to the model and serial numbers of your Wolf E series oven. This information is found on the product rating plate located below the control panel. The oven door must be open to view the rating plate. For location of the rating plate, refer to the illustration for your specific model on pages 6–7. Record the rating plate information below for future reference.

Model Number: \_\_\_\_\_

Serial Number: \_\_\_\_\_

Installation Date: \_\_\_\_\_

Wolf Factory Certified Service:

\_\_\_\_\_

Phone: \_\_\_\_\_

Authorized Wolf Dealer:

\_\_\_\_\_

Phone: \_\_\_\_\_

### BEFORE CALLING FOR SERVICE

Before calling Wolf factory certified service, refer to the troubleshooting guide on page 37.

### PRODUCT REGISTRATION

Register your new Wolf product today so that we may ensure your satisfaction. You may register by one of the following options:

- 1) Mail in the completed Wolf product registration card.
- 2) Register online at [wolfappliance.com](http://wolfappliance.com).
- 3) Register by phone by calling Wolf customer care at **800-222-7820**.

The model and serial numbers of your unit are printed on the enclosed Wolf product registration card. If you provide us with your e-mail address, we will send you exciting new product updates and recipes as they become available, along with information on special events.

The information and images in this guide are the copyright property of Wolf Appliance, Inc. Neither this guide nor any information or images contained herein may be copied or used in whole or in part without the express written permission of Wolf Appliance, Inc. ©Wolf Appliance, Inc. all rights reserved.

Wolf, Wolf & Design, Wolf Gourmet, W & Design and the color red as applied to knobs are registered trademarks and service marks of Wolf Appliance, Inc. Sub-Zero, Sub-Zero & Design, Dual Refrigeration, Constant Care and The Living Kitchen are registered trademarks and service marks of Sub-Zero, Inc. (collectively, the "Company Marks.") All other trademarks or registered trademarks are property of their respective owners in the United States and other countries.

# Wolf Appliance Products Limited Warranty

FOR RESIDENTIAL USE ONLY

## FULL TWO YEAR WARRANTY\*

For two years from the date of original installation, your Wolf Appliance product warranty covers all parts and labor to repair or replace, under normal residential use, any part of the product that proves to be defective in materials or workmanship. All service provided by Wolf Appliance under the above warranty must be performed by Wolf factory certified service, unless otherwise specified by Wolf Appliance, Inc. Service will be provided during normal business hours.

## LIMITED FIVE YEAR WARRANTY

For five years from the date of original installation, Wolf Appliance will repair or replace the following parts that prove to be defective in materials or workmanship: gas burners (excluding appearance), electric heating elements, blower motors (ventilation hoods), electronic control boards, magnetron tubes and induction generators. The part(s) will be repaired or replaced, free of charge, with the owner paying for all other costs including labor. All service provided by Wolf Appliance under the above warranty must be performed by Wolf factory certified service, unless otherwise specified by Wolf Appliance, Inc. Service will be provided during normal business hours.

## TERMS APPLICABLE TO EACH WARRANTY

The warranty applies only to products installed for normal residential use. The warranty applies only to products installed in any one of the fifty states of the United States, the District of Columbia or the ten provinces of Canada. This warranty does not cover any parts or labor to correct any defect caused by negligence, accident or improper use, maintenance, installation, service or repair.

**THE REMEDIES DESCRIBED ABOVE FOR EACH WARRANTY ARE THE ONLY ONES THAT WOLF APPLIANCE, INC. WILL PROVIDE, EITHER UNDER THIS WARRANTY OR UNDER ANY WARRANTY ARISING BY OPERATION OF LAW. WOLF APPLIANCE, INC. WILL NOT BE RESPONSIBLE FOR ANY CONSEQUENTIAL OR INCIDENTAL DAMAGES ARISING FROM THE BREACH OF THIS WARRANTY OR ANY OTHER WARRANTY, WHETHER EXPRESS, IMPLIED OR STATUTORY.**

Some states do not allow the exclusion or limitation of incidental or consequential damages, so the above limitation or exclusion may not apply to you. This warranty gives you specific legal rights and you may also have other legal rights that vary from state to state.

To receive parts and/or service and the name of Wolf factory certified service nearest you, contact Wolf Appliance, Inc., P.O. Box 44848, Madison, WI 53744; check the contact & support section of our website, [wolfappliance.com](http://wolfappliance.com) or call 800-222-7820.

\*Stainless steel doors, panels, handles, product frames and interior surfaces are covered by a limited 60-day parts and labor warranty for cosmetic defects.

\*Replacement filters for ventilation hood recirculating kits are not covered by the product warranty.







WOLF APPLIANCE, INC. P. O. BOX 44848 MADISON, WI 53744 WOLFAPPLIANCE.COM 800.222.7820

819065 REV-A

9/2011

