

# LIEBHERR

## Use and Care Manual

Combined BioFresh-freezer,  
built-in

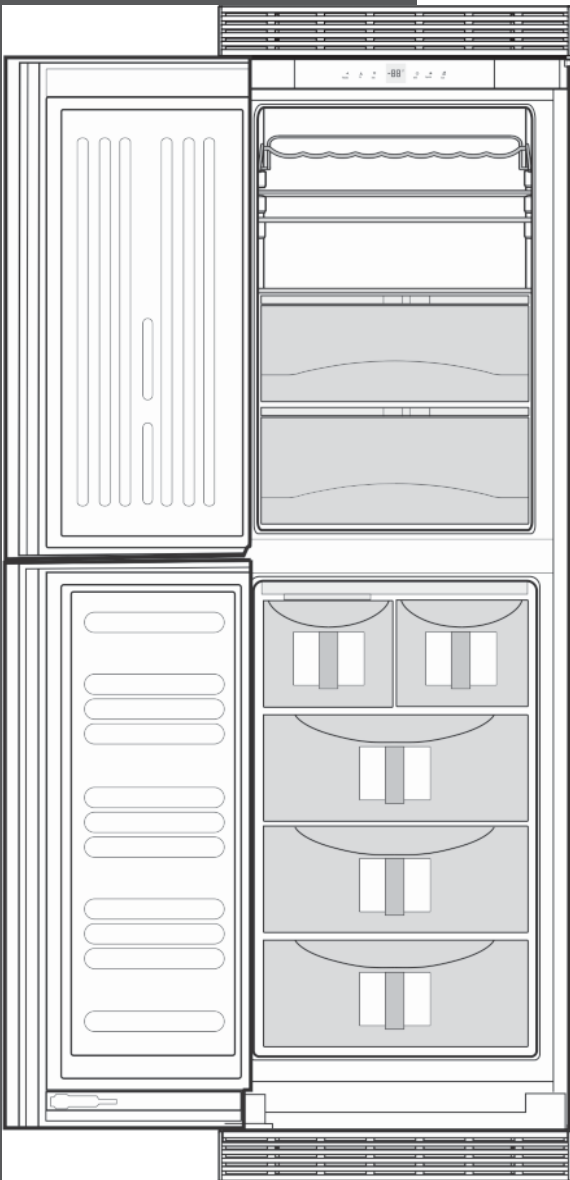

BF1061 BFI1061  
060514 7085372 - 00

# The appliance at a glance

## Contents

<b>1</b>	<b>The appliance at a glance.....</b>	<b>2</b>
1.1	Additional benefits.....	2
1.2	Range of appliance use.....	3
1.3	Conformity.....	3
1.4	Overview of the appliance and its equipment...	3
1.5	Energy saving.....	4
<b>2</b>	<b>General safety information.....</b>	<b>4</b>
<b>3</b>	<b>Controls and displays.....</b>	<b>5</b>
3.1	Operating and control elements.....	5
3.2	Temperature display.....	5
<b>4</b>	<b>Start-up.....</b>	<b>5</b>
4.1	Transporting the appliance.....	5
4.2	Setting up the appliance.....	5
4.3	Disposal of packaging.....	6
4.4	Connecting the appliance.....	6
4.5	Switching on the appliance.....	7
<b>5</b>	<b>Operation.....</b>	<b>7</b>
5.1	Temperature display unit.....	7
5.2	Brightness of the temperature display.....	7
5.3	Child-proof lock.....	8
5.4	Door alarm.....	8
5.5	Temperature alarm.....	8
5.6	Sabbath Mode.....	8
5.7	BioFresh compartment.....	9
5.8	Freezer compartment.....	10
<b>6</b>	<b>Maintenance.....</b>	<b>13</b>
6.1	Replacing the water filter.....	13
6.2	Defrosting with NoFrost.....	13
6.3	Cleaning the appliance.....	14
6.4	Cleaning the IceMaker.....	14
6.5	Customer service.....	15
6.6	Appliance Information.....	15
<b>7</b>	<b>Troubleshooting.....</b>	<b>15</b>
<b>8</b>	<b>Putting appliance out of service.....</b>	<b>18</b>
8.1	Vacation Tips.....	18
8.2	Switching off the appliance.....	18
8.3	Decommissioning .....	18
<b>9</b>	<b>Disposing of the appliance.....</b>	<b>19</b>
<b>10</b>	<b>Liebherr Warranty Plan.....</b>	<b>19</b>

Congratulations on the purchase of your new appliance. With this purchase, you have chosen all the advantages of the latest refrigeration technology, guaranteeing you a high-quality appliance with a long life span and high operating safety.

The equipment of your appliance gives you the highest level of day-to-day ease of operation.

Together we are making an active contribution to the conservation of our environment by purchasing this appliance which is manufactured in an environmentally friendly process with the use of recyclable materials.

We hope you enjoy your new appliance.

The manufacturer is constantly working to improve all models. Therefore please understand that we reserve the right to make design, equipment and technical modifications.

To get to know all the benefits of your new appliance, please read the information contained in these instructions carefully.

The instructions apply to several models, so there may be differences. Sections which only apply to certain appliances are indicated with an asterisk (\*).

**Instructions for action are marked with a ►, the results of action are marked with a ▷.**

## 1 The appliance at a glance

### 1.1 Additional benefits

- CFC free
- Energy-optimized refrigerant circuit
- Energy-efficient insulation
- Low energy consumption
- User-friendly electronic controls
- Active function indicators
- Temperature can be controlled in the appliance independent of ambient conditions according to its climate rating - Temperature can be displayed as °C or °F
- The appliance defrosts automatically - no need to spend time defrosting
- Large refrigeration capacity
- Safety glass storage shelves
- Large freezing capacity
- Shelves can be removed to make space for large items.
- Freezer over-temperature alarm
- Quick-freeze feature for fresh food (SuperFrost)
- Frozen food temperature indicator
- Power failure/"frost-control" display
- All freezer drawers suitable for quick-freeze
- Bright LED interior light
- Door ajar alarm
- Handle grips on all extra-large drawers for easy transport
- Integrated transport grips on appliance housing
- Transport castors at back
- Easy to clean
- Door hinges can be reversed
- Soft stop mechanisms
- This unit is certified as Sabbath compliant by the Star-K organization thus allowing the appliance to be used during religious holidays. For more information please visit Star-K on the web at [www.star-k.org](http://www.star-k.org).



## 1.2 Range of appliance use

The appliance is only suitable for refrigerating food in a domestic environment or an environment that is similar to a domestic one. This includes, for example, use

- in staff kitchens, bed and breakfast establishments,
- by guests in country houses, hotels, motels and other accommodation facilities,
- for catering and similar services in wholesale premises

Only use the appliance in a normal domestic setting. No other types of use are permissible. The appliance is not suitable for storing and refrigerating medicines, blood plasma, laboratory preparations or similar substances and products referred to in CMDCAS and FDA 510 (k). Misuse of the appliance may lead to damage to or spoiling of the goods stored. In addition the appliance is not suitable for operating in areas at risk of explosions.

The appliance is set to operate within specific ambient temperature limits according to its climate rating. The climate rating for your appliance is printed on the rating plate.

### Note

- Compliance with the specified ambient temperatures is required, otherwise the refrigeration performance is reduced.

Climate rating	for ambient temperatures from
SN	50 °F (10 °C) to 90 °F (32 °C)
N	61 °F (16 °C) to 90 °F (32 °C)
ST	61 °F (16 °C) to 101 °F (38 °C)
T	61 °F (16 °C) to 110 °F (43 °C)

## 1.3 Conformity

The refrigerant circuit has been tested for leaks. The appliance complies with the relevant safety regulations and the directives UL250 and CAN/CSA C22.2 No.63-93.

BioFresh meets EN ISO 8561 requirements for a chill compartment.

### Instructions for testing institutes:

Tests must be carried out in accordance with the applicable standards and guidelines.

The preparation and testing of the appliance must be carried out taking account of **the manufacturer's**

loading plans and the instructions in the operating manual .

## 1.4 Overview of the appliance and its equipment

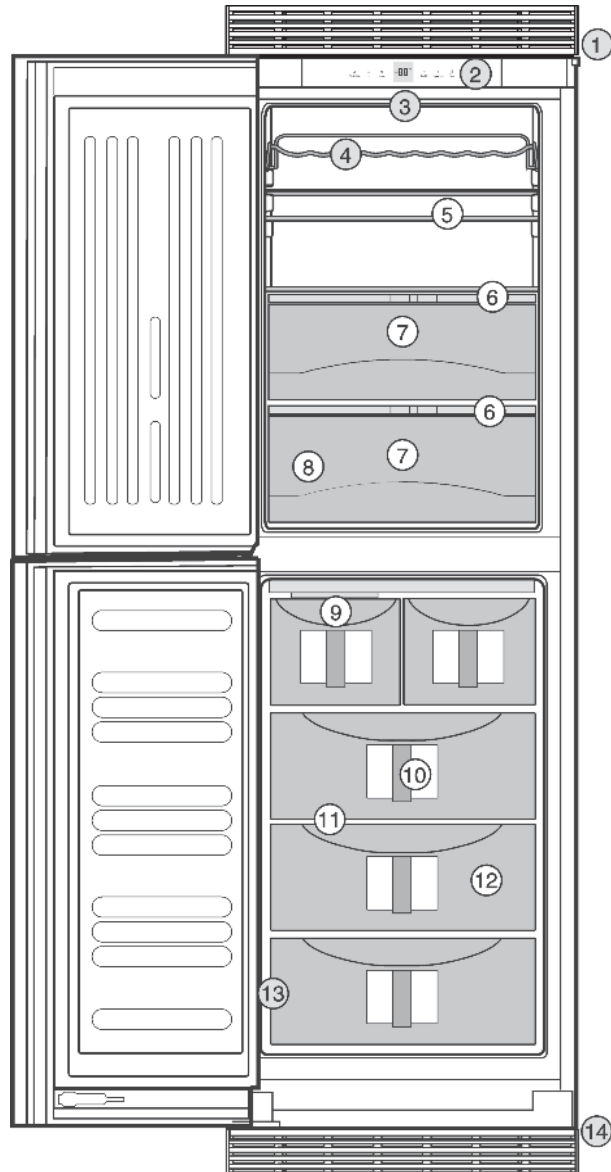

Fig. 1

- |                                    |   |
|------------------------------------|---|
| (1) Rear transport handles         | (8) Drain hole  |
| (2) Operating and control elements | (9) IceMaker  |
| (3) Interior light                 | (10) InfoSystem   |
| (4) Bottle shelf                   | (11) VarioSpace   |
| (5) Shelf, adjustable              | (12) Freezer compartment  |
| (6) BioFresh controller            | (13) Rating plate   |
| (7) HydroSafe                      | (14) Adjustable feet, front transport handles, rear transport castors |

# General safety information

---

## 1.5 Energy saving

- Always ensure good ventilation. Do not obstruct ventilation openings or grilles.
- Do not install the appliance in direct sunlight or next to an oven, heater, or similar heat source.
- Energy consumption depends on installation conditions such as the ambient temperature (see 1.2) .
- Avoid opening the appliance door for any longer than necessary.
- The lower the temperature is set the higher the energy consumption.
- All food stored in the appliance should be well wrapped and covered. This prevents frost buildup.
- Only take food out for as long as necessary so that it does not get too warm.
- Storing hot food: let it cool to room temperature first.

## 2 General safety information

Read and follow these instructions. They contain safety advice which is important for safe and problem-free installation and operation. Always read and follow the safety advice.

### Dangers for the user:

- This appliance can be operated by children 8 years and older as well as by persons with reduced physical, sensory or mental capabilities or lack of experience and knowledge if they are supervised or have been instructed in the safe use of the appliance and understand the associated risks. Children must not play with the appliance. Cleaning and user maintenance must not be performed by children unless they are supervised.
- When disconnecting the appliance from the outlet, always take hold of the plug. Do not pull on the cable.
- Disconnect the power plug or switch off the power if a fault occurs.
- Do not damage the mains power line. Do not operate the appliance from a defective mains power line.
- Repairs, work on the appliance and replacement of the power cord should only be carried out by the customer service department.
- The appliance should only be assembled, connected and disposed of in accordance with the instructions.
- Only install, connect and dispose of the appliance in accordance with the instructions.
- Only operate the appliance after it has been installed.

- Please keep the instructions and pass them on to any future owner.
- All repairs to or work on the IceMaker must only be carried out by the customer service department or other specialist engineers trained to do this.
- The manufacturer is not liable for damage arising from incorrect connection to the water supply.

### Risk of fire:

- Do not operate the appliance near explosive gases.
- Do not store explosive materials or spray cans with flammable propellants, such as e.g. butane, propane, pentane, etc. in the appliance. You can recognize such spray cans by the printed contents or a flame symbol. Any leaking gasses can be ignited by electrical components.
- Keep burning candles, lamps and other objects with open flames away from the appliance so that they do not set it on fire.
- Alcoholic beverages or other containers holding alcohol must always be tightly sealed for storage purposes. Any leaking alcohol can be ignited by electrical components

### Tipover hazard:

- Do not stand or climb on the base, drawers, doors, etc. This applies in particular to children.

### Risk of food poisoning:

- Do not consume food that has passed its best before date.

### Danger of frostbite, feelings of numbness and pain:

- Avoid continued skin contact with the cold surfaces or chilled/frozen food or adopt protective measures, e. g. use gloves. Do not consume ice cream (especially sherbets) and ice cubes immediately when they are too cold.

### Risk of injury and damage:

- Hot steam may lead to injuries. Do not use any electrical heating or steam cleaning equipment, naked flames or defrosting sprays for defrosting
- Do not remove ice with sharp objects

### Risk of crushing

- Do not reach into the soft stop mechanism. Fingers may be trapped when the door is closed.

Follow the specific instructions in the other sections:

	DANGER	indicates a hazardous situation, which if not avoided, will result in death or serious injury.
	WARNING	indicates a hazardous situation, which if not avoided, could result in death or serious injury.
	CAUTION	indicates a hazardous situation, which if not avoided, will result in minor or moderate injury.
	NOTICE	indicates a hazardous situation, which if not avoided, could result in damage to property.
	Note	indicates useful advice and tips.

## 3 Controls and displays

### 3.1 Operating and control elements

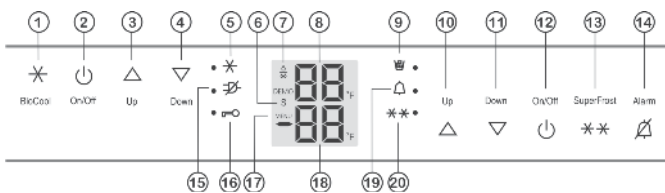

Fig. 2

- |  |  |
|--|--|
| (1) BioCool button                           | (11) Freezer compartment Down button         |
| (2) BioFresh compartment On/Off button       | (12) Freezer compartment On/Off button       |
| (3) BioFresh compartment Up button           | (13) SuperFrost button                       |
| (4) BioFresh compartment Down button         | (14) Alarm button                            |
| (5) BioCool symbol                           | (15) Power failure symbol                    |
| (6) Sabbath Mode symbol                      | (16) Child safety symbol                     |
| (7) Filter symbol                            | (17) Menu symbol                             |
| (8) BioFresh compartment temperature display | (18) Freezer compartment temperature display |
| (9) IceMaker symbol                          | (19) Alarm symbol                            |
| (10) Freezer compartment Up button           | (20) SuperFrost symbol                       |

The exact contact point is between the symbol and its label

### 3.2 Temperature display

The following is displayed in normal operation:

- the highest freezer temperature
- the average BioFresh temperature

The freezer compartment temperature display is flashing:

- the temperature setting has been changed
- after switch-on the temperature is not yet cold enough
- the temperature has risen several degrees

Dashes are shown on the display:

- the freezer temperature is above 32 °F (0 °C).

The following displays indicate malfunction. Possible causes and corrective actions: (see Troubleshooting).

- **F0** through **F9**
- **FE**
- The power failure symbol LED flashes.

## 4 Start-up

### 4.1 Transporting the appliance



#### CAUTION

Risk of injury or damage if incorrectly transported.

- ▶ Transport the appliance in its packaging.
- ▶ Transport the appliance upright.
- ▶ Do not move the appliance on your own.

### 4.2 Setting up the appliance



#### WARNING

Risk of fire due to moisture!

If live parts or the power cord get wet, this can cause a short circuit.

- ▶ The appliance is designed for use in enclosed spaces. Do not operate the appliance in open space or in damp areas or where there is spray.
- ▶ Only operate the appliance after it has been installed.



#### WARNING

Risk of fire due to short circuit.

If the power cable or plug of the appliance or another appliance and the back of the appliance touch each other the power cable or plug will be damaged by the vibrations of the appliance which could lead to a short circuit.

- ▶ Install the appliance so that it does not touch any plugs or power cables.
- ▶ Do not connect the appliance or other appliances to the sockets on the back of the appliance.



# Start-up



## WARNING

Danger of fire and damage!

- ▶ Do not place devices that give off heat, e.g. microwaves, toasters, etc. on the appliance.



## CAUTION

Risk of personal injury!

- ▶ Have two people move this appliance into place.

## NOTICE

Risk of damage caused by condensation

Installing the appliance next to any other refrigerator or freezer can cause condensation or damage to the Liebherr appliance.

- ▶ Do not install this appliance next to any other refrigerator or freezer except another Liebherr model. Liebherr models are designed to allow side-by-side installation. They are equipped with a heating system to eliminate condensation when refrigerators or freezers are installed side-by-side.

## NOTICE

Risk of damage for the finished floor surface!

- ▶ Protect the finished floor surface before you uncrate the unit.

Verify that:

- The floor under the appliance is flat and level.
- The floor can support the appliance's weight plus approximately 1200 pounds (544 kg) of food weight.
- The appliance is not placed in direct sunlight or near the stove, range top, radiators and similar heat sources.
- The kitchen cabinet that the appliance is installed in is shimmed to the floor level if the floor heights are not equal.
- Cutout dimensions are accurate.
- Electrical outlet is in correct location.
- The air flow is not restricted. Air flow must be provided for the appliance to operate properly. The factory air vents provide 31 square inches (200 cm<sup>2</sup>) of air flow per appliance. If you are replacing the air vents with an overlay, the air flow must be the same or greater than the factory air vents.
- ▶ Examine the unit and packaging for shipping damage. Contact the carrier immediately if you suspect there is any damage.
- ▶ Note the type (model, number), index, appliance/serial number, date of purchase and where purchased (see 6.6).
- ▶ Remove anything attached to the rear or side walls of appliance that would prevent proper installation or impede proper ventilation.
- ▶ Remove the protective film from the outside of the appliance.

## Note

- ▶ Clean the appliance (see 6.3).

If the appliance is set up in humid areas, condensation may build on the outside of the appliance.

- ▶ Always ensure proper ventilation.
- ▶ Assemble appliances according to separate installation instructions.

## 4.3 Disposal of packaging



## WARNING

Danger of suffocation from packaging materials and films!

- ▶ Do not allow children to play with packaging materials.

The packaging is made from recyclable materials:

- Corrugated card/cardboard
- Parts made of foamed polystyrene
- Films and bags from polyethylene
- Packing bands from polypropylene
- Wood frame nailed together with a polyethylene window\*

- ▶ Take the packaging material to an official collection point.



## 4.4 Connecting the appliance



## WARNING

Electrical shock hazard!

- ▶ Start-up should only take place once the appliance has been installed according to these instructions.
- ▶ Electrically ground appliance.
- ▶ Do not ground to a gas pipe.
- ▶ Check with a qualified electrician if you are not sure the appliance is properly grounded.
- ▶ Do not have a fuse in the neutral or grounding circuit.
- ▶ Do not use an extension cord, power bar or a multiple socket adapter.
- ▶ Do not use a power cord that is frayed or damaged.



## WARNING

Electrical shock hazard!

This appliance is equipped with a three-prong (grounding) polarized plug for your protection against possible shock hazards. Electrical Grounding Required.

- ▶ Do not remove the round grounding prong from the plug.
- ▶ Use only an grounded adapter.

- Wait 1 hour after installation before you plug in the appliance. This allows the refrigerant and system lubrication to reach equilibrium.
- Make sure incoming voltage is the same as the appliance rating. A 110-120 Volt, 60 Hz, 15 Amp electrical supply (20 Amp for side-by-side installations) circuit that is controlled by a circuit breaker or fuse is required.

- We recommend using a dedicated circuit for this appliance to prevent electrical overload.
- Follow all Federal, State and local electrical, fire and building codes and ordinances when installing the receptacle and / or the appliance.
- In some communities, a wall switch is required to turn power to the appliance ON and OFF.
- To reduce the risk of fire, electric shock, or personal injury, installation work and electrical wiring must be done by a qualified electrician in accordance with all applicable codes and standards, including fire-rated construction.
- The Power Plug must be easily accessible so that the appliance can be disconnected from the mains quickly in an emergency. It must not be behind the back of the appliance.
- The top of the electric outlet must be located within 82-5/8 in. (2100 mm) from the top of the base in the cabinet.

## 4.5 Switching on the appliance

### Note

- ▶ To switch on the entire appliance, only the freezer compartment needs to be switched on.

Switch on the appliance 2 hours before loading with frozen food for the first time.

Do not load frozen foods until the temperature display reads 0 °F (-18 °C).



### 4.5.1 Switching on the freezer compartment

- ▶ Open the door.
- ▶ Press On/Off button, freezer compartment *Fig. 2 (12)*.
- ▷ The BioFresh temperature display shows the current temperature in the interior.
- ▷ The freezer compartment temperature display and the Alarm symbol will flash until the temperature is cold enough. If the temperature is greater than 32 °F (0 °C), flashing dashes will appear; if the temperature is lower than this, the current temperature will flash on the display.
- ▷ Whenever “DEMO” appears on the display, the appliance is running in demonstration mode. Contact the customer service department.

### 4.5.2 Switching on the BioFresh compartment

- ▶ Open the door.
- ▶ Press BioFresh compartment On/Off button *Fig. 2 (2)*.
- ▷ The temperature display flashes.
- ▷ The interior light comes on when the door is opened.

## 5 Operation

### 5.1 Temperature display unit

The temperature display can be changed from °F to °C.

#### 5.1.1 To change the unit

- ▶ Activate setting mode: Press SuperFrost button *Fig. 2 (13)* for about 5 seconds.
  - ▷ 5 is displayed in the temperature display.
  - ▷ The Menu symbol *Fig. 2 (17)* lights up.
  - ▶ Using Freezer compartment Up button *Fig. 2 (10)*/ Freezer compartment Down button *Fig. 2 (11)* select °.
  - ▶ To confirm: Briefly press SuperFrost button *Fig. 2 (13)*.
  - ▶ Using Freezer compartment Up button *Fig. 2 (10)*/ Freezer compartment Down button *Fig. 2 (11)* select °F or °C.
  - ▶ To confirm: Briefly press SuperFrost button *Fig. 2 (13)*.
  - ▶ To exit setting mode: Press Freezer compartment On/Off button *Fig. 2 (12)*.
- or-**
- ▶ Wait 5 minutes.
  - ▷ The temperature is again displayed in the temperature display.



### 5.2 Brightness of the temperature display

You can adapt the brightness of the temperature display to the light conditions in the room in which it is installed.

If the door is open or the control panel is used the temperature indicator lights up at maximum brightness. About 1 minute after the door is closed or no button has been pressed on the control panel, the temperature display goes back to the set brightness.

#### 5.2.1 Setting the brightness

The brightness can be set between h0 (minimum luminosity) and h5 (maximum luminosity).

- ▶ To activate setting mode: Press SuperFrost button *Fig. 2 (13)* for about 5 seconds.
- ▷ 5 is shown on the display.
- ▷ The Menu symbol *Fig. 2 (17)* lights up.
- ▶ Press Freezer compartment Up button *Fig. 2 (10)* or Freezer compartment Down button *Fig. 2 (11)* to select h.
- ▶ To confirm: Briefly press SuperFrost button *Fig. 2 (13)*.
- ▶ To set the display brighter: Press Freezer compartment Up button *Fig. 2 (10)*.
- ▶ To set the display darker: Press Freezer compartment Down button *Fig. 2 (11)*.
- ▶ To confirm: Press SuperFrost button *Fig. 2 (13)*.
- ▷ The brightness is set to the new value.
- ▶ To deactivate setting mode: Press Freezer compartment On/Off button *Fig. 2 (12)*.



- or-**
- ▶ Wait 5 minutes.

- ▷ The temperature is again displayed in the temperature display.

# Operation

## 5.3 Child-proof lock

You can use the child-proof lock to lock the buttons. This means that children cannot accidentally switch off the appliance when playing.



### 5.3.1 Switching on the child-proof lock

▶ Activate setting mode: press and hold the SuperFrost button *Fig. 2 (13)* for approximately 5 s.

▷ 5 is shown on the display.

▷ The Menu symbol *Fig. 2 (17)* lights up.

▶ Using the Freezer compartment Up button *Fig. 2 (10)* or Freezer compartment Down button *Fig. 2 (11)*, select **c**.

▶ Press the SuperFrost button *Fig. 2 (13)* briefly to confirm.

When **c1** is shown on the display:

▶ To switch on the child-proof lock, press the SuperFrost button *Fig. 2 (13)* briefly.



▷ The Child lock symbol *Fig. 2 (16)* LED lights up. **c** flashes on the display.

When **c0** is shown on the display:

▶ To switch off the child-proof lock, press the SuperFrost button *Fig. 2 (13)* briefly.

▷ The Child safety symbol *Fig. 2 (16)* LED goes out. **c** flashes on the display.

▶ Deactivate setting mode: press the Freezer compartment On/Off button *Fig. 2 (12)*.

-or-

▶ Wait 5 min.

▷ The temperature is again displayed on the temperature display.

## 5.4 Door alarm

If the door is open for longer than 180 seconds, the acoustic warning sounds.

The acoustic warning stops automatically when the door is closed.



### 5.4.1 Switching off the door alarm

The acoustic warning can be switched off when the door is open. The acoustic warning remains switched off as long as the door is open. When the door is closed, the alarm function is active again.

▶ Press Alarm button *Fig. 2 (14)*.

▷ The door alarm stops.

## 5.5 Temperature alarm

If the freezer temperature is not cold enough, the audible warning sounds.

At the same time, the temperature display and the Alarm symbol *Fig. 2 (19)* LED will flash.



The cause of a temperature being too high may be:

- Hot fresh food was placed in the appliance.

- When sorting and removing food from the appliance, too much warm ambient air got in.
- The power was cut off for a while.
- The appliance is faulty.

The audible warning automatically ceases, the Alarm symbol *Fig. 2 (19)* goes out, and the temperature display stops flashing when the temperature is cold enough again.

If the alarm status remains: (see Troubleshooting).

### Note

If the temperature is not cold enough, food may spoil.

▶ Check the quality of the food. Do not consume spoiled food.

## 5.5.1 Switching off the temperature alarm

The acoustic warning can be switched off. When the temperature is cold enough again, the alarm function is active again.

▶ Press Alarm button *Fig. 2 (14)*.

▷ The acoustic warning ceases.

## 5.6 Sabbath Mode

After entering Sabbath Mode, you do not have to worry about lights, digits, icons, tones, alarms or fans. The defrost cycle operates solely on clock time without any feedback from usage of the refrigerator. After a power failure, the appliance will return to Sabbath Mode without requiring additional input.



### WARNING

Danger of food poisoning!

No record will be kept of a power failure during Sabbath Mode. Thus, during Sabbath mode, if a power failure occurs that you are not aware of, when the power comes back on, the unit will continue to be in Sabbath Mode but when Sabbath Mode is ended there will be no indication that a power failure occurred.

If a power failure occurs during Sabbath mode:

▶ Check the quality of the food. Do not consume spoiled food!

- No control operations are possible other than switching off Sabbath Mode.
- If the unit is currently running in a mode such as Superfrost, Supercool or the Ventilation is enabled these functions will continue and finish their timed cycles independent of now being in Sabbath mode.
- The Ice Maker is disabled.
- No audible signals are emitted, and the temperature display does not indicate any warnings or settings (such as a temperature alarm or door alarm).
- Light does not operate.

### 5.6.1 Setting Sabbath mode

▶ To activate setting mode: Press and hold the SuperFrost button *Fig. 2 (13)* for approx. 5 s.



- ▷ 5 flashes on the display.
- ▷ The Menu symbol *Fig. 2 (17)* lights up.
- ▶ To access the Sabbath mode function: Briefly press the SuperFrost button *Fig. 2 (13)*.

When 51 is shown on the display:



- ▶ **To turn on Sabbath mode**, briefly press the SuperFrost button *Fig. 2 (13)*.

When 50 is shown on the display:



- ▶ **To turn off Sabbath mode**, briefly press the SuperFrost button *Fig. 2 (13)*.

- ▶ To deactivate setting mode: Press the Freezer compartment On/Off button *Fig. 2 (12)*.

**-or-**

- ▶ Wait 5 min.

- ▷ The Sabbath Mode symbol *Fig. 2 (6)* appears on the temperature display as long as Sabbath Mode is active.
- ▷ Sabbath mode switches off automatically after 120 hours if it is not manually switched off beforehand.

## 5.7 BioFresh compartment

The BioFresh compartment allows you to store certain fresh foods up to three times longer compared to conventional refrigeration systems, without sacrificing quality.

Food with a “use by” date must still be consumed by the date indicated on the package.

The taste, freshness, and nutritional value (vitamin B and C groups) of the food are preserved to a large extent. Fruit and vegetables spoil less quickly and lose less water, and food remains fresher and more wholesome.

### 5.7.1 HydroSafe

On the humid setting, the HydroSafe is suitable for storing loose-leaf lettuce, vegetables, and fruit with a high moisture content. When the drawer is full, this creates a cool, fresh environment with an air humidity of up to 90%. The humidity level in the compartment depends on the moisture content of the food inside and on how often the compartment is opened. You can adjust the humidity yourself.

### 5.7.2 Storing food

#### Note

- ▶ Do not store vegetables that do not support cold temperatures (such as cucumbers, eggplant, semi-ripe tomatoes, zucchini, and all cold-sensitive exotic fruits) in the BioFresh compartment.

The fresher the product and the better the quality, the longer it can be stored.

- ▶ When shopping, make sure the food you purchase is fresh.
- ▶ To prevent spoilage due to the transfer of bacteria: Store unpackaged animal products and plant-based products in separate compartments. This also applies for different types of meat.
- ▶ If you must store food together to save space:
- ▶ Keep the food packaged.

### 5.7.3 Storage times

Guidelines for storage at low humidity			
Butter	up to	90	days
Hard cheese	up to	110	days
Milk	up to	12	days
Sausage, cold cuts	up to	9	days
Poultry	up to	6	days
Pork	up to	7	days
Beef	up to	7	days
Game	up to	7	days

#### Note

- ▶ Note that higher-protein foods spoil more quickly. This means that shellfish and crustaceans spoil more quickly than fish, and fish spoils more quickly than meat.

Guidelines for storage at high humidity			
Vegetables, lettuce			
Artichokes	up to	14	days
Celery	up to	28	days
Cauliflower	up to	21	days
Broccoli	up to	13	days
Endives	up to	27	days
Mâche	up to	19	days
Peas	up to	14	days
Kale	up to	14	days
Carrots	up to	80	days
Garlic	up to	160	days
Kohlrabi	up to	55	days
Iceberg lettuce	up to	13	days
Herbs	up to	13	days
Leeks	up to	29	days
Mushrooms	up to	7	days
Radishes	up to	10	days
Brussels sprouts	up to	20	days
Asparagus	up to	18	days
Spinach	up to	13	days
Savoy cabbage	up to	20	days
Fruit			
Apricots	up to	13	days
Apples	up to	80	days
Pears	up to	55	days

# Operation

Guidelines for storage at high humidity			
Blackberries	up to	3	days
Dates	up to	180	days
Strawberries	up to	7	days
Figs	up to	7	days
Blueberries	up to	9	days
Raspberries	up to	3	days
Red currants	up to	7	days
Cherries, sweet	up to	14	days
Kiwi	up to	80	days
Peaches	up to	13	days
Plums	up to	20	days
Cranberries	up to	60	days
Rhubarb	up to	13	days
Gooseberries	up to	13	days
Grapes	up to	29	days

## 5.7.4 Setting the temperature

The temperature in the BioFresh compartment is automatically regulated to just above 32 °F (0 °C).

You can set a slightly higher or lower temperature. The temperature can be adjusted between **b1** (coldest temperature) and **b9** (hottest temperature) The default setting is **b5**. If you select a setting between **b1** and **b4**, the temperature may fall below 32 °F (0 °C) so that the food may freeze slightly as a result.

- ▶ To set a higher temperature: Press the BioFresh compartment UP button *Fig. 2 (3)*.
- ▶ To set a lower temperature: Press the BioFresh compartment DOWN button *Fig. 2 (4)*.
- ▷ When the button is pressed for the first time, the previous value is indicated on the BioFresh temperature display.
- ▶ To change the temperature gradually: Press the button briefly.

**-or-**

- ▶ To change the temperature continuously: Hold the button down.

- ▷ The values **b1** to **b9** are displayed while the settings are being changed.
- ▷ The actual temperature is displayed about 5 seconds after the last button has been pressed. The temperature slowly adjusts to the new value.

## 5.7.5 BioCool

With BioCool you switch to the highest refrigeration power. Use BioCool to cool large quantities of food rapidly.

BioCool uses a slightly more energy.



## Switching on BioCool

- ▶ Press the BioCool *Fig. 2 (1)* button briefly.
- ▷ The BioCool symbol *Fig. 2 (5)* LED lights up.

## Switching off BioCool

- ▶ Press the BioCool *Fig. 2 (1)* button briefly.
- ▷ The BioCool symbol *Fig. 2 (5)* LED goes out.

## 5.7.6 Adjusting the humidity in the Hydro-Safe

- ▶  Low humidity: Move the slide control to the left.
- ▶  High humidity: Move the slide control to the right.

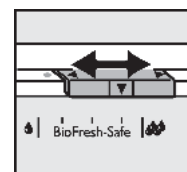

## 5.7.7 Drawers

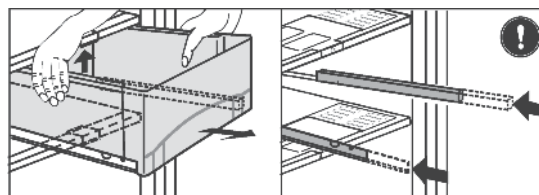

*Fig. 3*

- ▶ Pull the drawer out, lift the back, and pull forward to remove.
- ▶ Slide the rails back in!

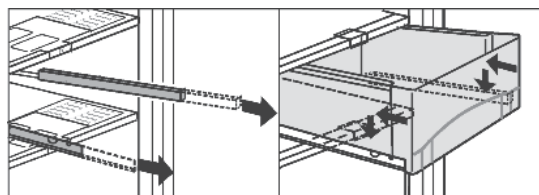

*Fig. 4*

- ▶ Pull the rails out.
- ▶ Place the drawer on the rails and slide it all the way in until you hear it snap into place.

## 5.7.8 Humidity control plate

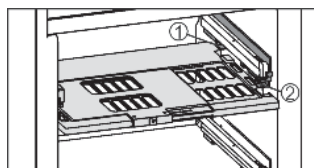

*Fig. 5*

- ▶ To remove the humidity control plate: After removing the drawers, carefully pull the plate forward and down to remove.
- ▶ To insert the humidity control plate: Insert the guide pieces of the plate into the rear retainer *Fig. 5 (1)* from below, then snap the plate into the retainer *Fig. 5 (2)* in the front.

## 5.8 Freezer compartment

You can store frozen food, make ice cubes and freeze fresh food in the freezer compartment.

## 5.8.1 Freezing food

Each drawer can hold up to 55.12 lbs (25 kg) of frozen food; each plate can hold up to 77.16 lbs (35 kg).



### CAUTION

There is a risk of injury from pieces of broken glass. Bottles and cans containing drinks can split or crack when frozen. This applies in particular to carbonated drinks.

- ▶ Do not freeze bottles and cans containing drinks.

So that the food is rapidly frozen through to the core, do not exceed the following quantities per pack:

- fruit, vegetables up to 2.2 lb (1 kg)
- meat up to 5.51 lbs (2.5 kg)
- ▶ Pack the food in portions in freezer bags, reusable plastic, metal or aluminum containers.

## 5.8.2 Defrosting food

- in the fridge compartment
- at room temperature
- in the microwave
- in the oven/fan oven



### WARNING

Danger of food poisoning!

- ▶ Do not re-freeze defrosted food.
- ▶ Only take out the amount of food that is required. Use defrosted food as quickly as possible.

## 5.8.3 Setting the temperature in the freezer compartment

The appliance is set as standard for normal operation.

The temperature can be set between 7 °F (-14 °C) and -16 °F (-26 °C), 0 °F (-18 °C) is recommended.

- ▶ To set a higher temperature: press the Freezer compartment Up button *Fig. 2 (10)*.
- ▶ To set a lower temperature: press the Freezer compartment Down button *Fig. 2 (11)*.
- ▷ When the button is pressed for the first time, the previous value is indicated on the freezer compartment temperature display.
- ▶ To change the temperature in 1 °F (1 °C) increments: briefly press the button.

-or-

- ▶ To change the temperature continuously: hold the button down.
- ▷ The value is displayed flashing during the setting operation.
- ▷ The actual temperature is displayed about 5 seconds after the last press of a button. The temperature slowly adjusts to the new setting.

## 5.8.4 SuperFrost



Depending on how much fresh food is to be frozen you must switch SuperFrost on in advance - for a small amount of food to be frozen, about 6 hours, for the maximum amount about 24 hours before putting the food in.

You do not need to switch SuperFrost on in the following cases:

- when placing frozen food in the freezer
- when freezing up to about 2 kg of fresh food a day

### Freezing with SuperFrost

- ▶ Briefly press the SuperFrost button *Fig. 2 (13)* once.
- ▷ The SuperFrost symbol *Fig. 2 (20)* LED lights up.
- ▷ The freezing temperature drops and the appliance operates at its maximum refrigeration power rating. When a small amount of food is to be frozen.
- ▶ Wait approx. 6 hrs.
- ▶ Place packaged food in the upper drawers. When the maximum amount of food is to be frozen.
- ▶ Wait approx. 24 hrs.
- ▶ Remove upper drawers and place the food directly onto the upper shelves.
- ▷ SuperFrost is automatically switched off. At the earliest after 30 hours, at the latest after 65 hours, depending on the quantity placed inside the appliance.
- ▷ The SuperFrost button *Fig. 2 (13)* goes out when the freezing process is complete.
- ▷ The LED for the SuperFrost symbol *Fig. 2 (20)* goes out when the freezing process is complete.
- ▶ Place food inside the drawers and push them closed again.
- ▷ The appliance returns to work in the energy-saving normal mode.

## 5.8.5 Drawers

### Note

Insufficient ventilation results in an increase in energy consumption and reduction of the refrigerating performance.

For appliances with NoFrost:

- ▶ Leave the bottom drawer in the appliance.
- ▶ Never block the air slits in the fan on the rear wall.

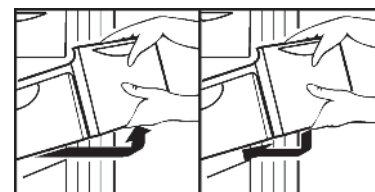

- ▶ To store frozen food directly on the shelves: pull the drawer forward and lift it out.

# Operation

## 5.8.6 Shelves

- ▶ To remove shelf: lift it at the front and pull out forward.
- ▶ To reinsert shelf: simply slide it in as far as it will go.

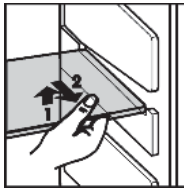

## Switching on the IceMaker

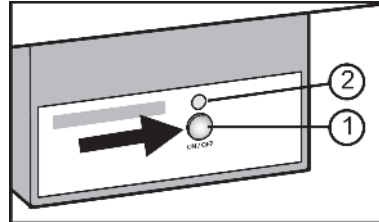

Fig. 7

- ▶ Pull out the drawer.
- ▶ Press On/Off button Fig. 7 (1) so that the LED Fig. 7 (2) lights up.
- ▶ Push in the drawer.
- ▷ The IceMaker symbol Fig. 2 (9) LED lights up.

## 5.8.7 VarioSpace

In addition to the drawers, you can also take out the shelves. This gives you space for large frozen items. Poultry, meat, large joints of game and tall bakery items can be frozen and then presented whole.

- ▶ Each drawer can hold up to 55.12 lbs (25 kg) of frozen food; each plate can hold up to 77.16 lbs (35 kg).

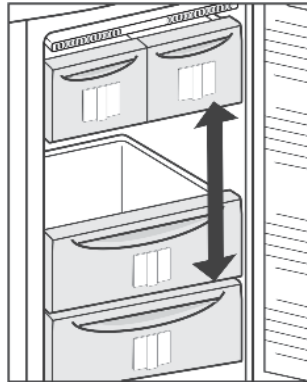

### Note

- ▶ The IceMaker only produces ice cubes when the drawer is completely closed.

### Producing ice cubes

The production capacity depends on the freezer temperature. The lower the temperature, the more ice cubes can be produced in a certain period.

The production capacity is 90- 100 ice cubes in 24 hours at a freezing temperature of 0 °F (-18 °C).

To have the maximum capacity of approx. 130 ice cubes in 24 hours, activate the SuperFrost Function. Be aware that this increases the energy consumption because the compressor will run constantly.

The ice cubes fall out of the IceMaker into the drawer. When the ice cubes reach a certain height in the drawer, no more ice cubes can be produced. The IceMaker will not fill the drawer to the top.

If large quantities of ice cubes are required, the complete IceMaker drawer can be swapped with the neighboring drawer. When you close the drawer, the IceMaker automatically restarts production.

When the IceMaker is switched on for the first time, it may take up to 24 hours for the first ice cubes to be produced.

### Note

Particles may accumulate in the IceMaker or water line the first time the appliance is used or after an extended period out of service.

- ▶ To achieve this, do not consume or use the ice cubes that are produced within 72 hours.

## 5.8.8 Info system



Fig. 6

- |                            |                        |
|----------------------------|------------------------|
| (1) Ready meals, ice cream | (4) Sausages, bread    |
| (2) Pork, fish             | (5) Game, mushrooms    |
| (3) Fruit, vegetables      | (6) Poultry, beef/veal |

The numbers indicate the storage time in months for different types of frozen foods. The storage times given are guidelines.

## 5.8.9 IceMaker

The IceMaker is in the top drawer. The drawer is labeled "IceMaker".

Make sure that the following conditions are fulfilled:

- The appliance is level.
- The appliance is connected to the electricity supply.
- The freezer compartment is switched on.
- The minimum freezer temperature is 14 °F (-10 °C).
- The IceMaker is connected to the water supply.
- All air was bled from the waterline before starting the icemaker. The icemaker will only work if there is no air in the waterline.

### Setting the water supply time

The opening time of the valve on the IceMaker can be adjusted if, for example, the water pressure in the pipe is too low or too high.

The water supply time can be set in stages from **E1** (short supply time) to **E8** (long supply time). The default setting is **E3**.

- ▶ Activate setting mode: press and hold the SuperFrost button Fig. 2 (13) for approximately 5 s.
- ▷ **5** is shown on the display.
- ▷ The Menu symbol Fig. 2 (17) lights up.



- ▶ Using the Freezer compartment Up button *Fig. 2 (10)* or Freezer compartment Down button *Fig. 2 (11)*, select **E**.
- ▶ To confirm: briefly press the SuperFrost button *Fig. 2 (13)*.
- ▶ To increase the water supply time: press the Freezer compartment Up button *Fig. 2 (10)*.
- ▶ To decrease the water supply time: press the Freezer compartment Down button *Fig. 2 (11)*.
- ▶ To confirm: press the SuperFrost button *Fig. 2 (13)*.
- ▶ Deactivate setting mode: press the Freezer compartment On/Off button *Fig. 2 (12)*.



**-or-**

- ▶ Wait 5 mins.
- ▷ The temperature is again displayed on the temperature display.

## Switching off the IceMaker

If ice cubes are not required, the IceMaker can be switched off independently of the freezer compartment.

When the IceMaker is switched off, the drawer of the IceMaker can also be used for freezing and storing food.

- ▶ Press the On/Off button for about 1 second until the LED goes out.
- ▷ The IceMaker symbol *Fig. 2 (9)* LED goes out.
- ▶ Clean the IceMaker.
- ▷ This ensures that no water or ice remains in the IceMaker.

## 6 Maintenance

### 6.1 Replacing the water filter

The water filter should be changed when the Filter symbol *Fig. 2 (7)* lights up. It should be replaced every six months at least or whenever you notice a significant decrease in the flow rate. You can order one from your dealer or by visiting our web site at [www.liebherr-appliances.com](http://www.liebherr-appliances.com).

The used water filter contains activated carbon and can be disposed of with normal household waste.

#### To remove the old water filter:

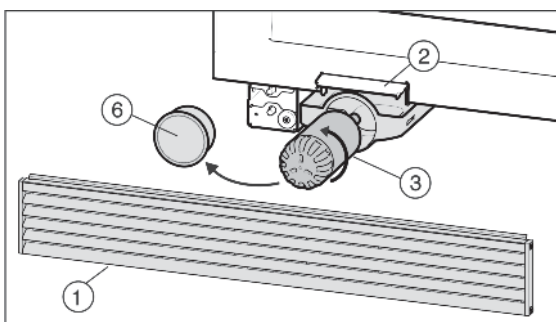

*Fig. 8*

- ▶ lift the ventilation grid *Fig. 8 (1)* up and pull out.
- ▶ Open the filter change flap *Fig. 8 (2)*.
- ▶ Pull the water filter carriage *Fig. 8 (3)* out.
- ▶ Remove the filter cover *Fig. 8 (6)*.
- ▶ Catch any dripping water with your hand or with a dish.

- ▶ Turn the water filter *Fig. 8 (3)* about 100° anti-clockwise and pull out.

#### Note

If no new water filter is inserted:

- ▶ put the filter cover on to protect the filter unit from dirt and dust.

#### To install a new water filter:

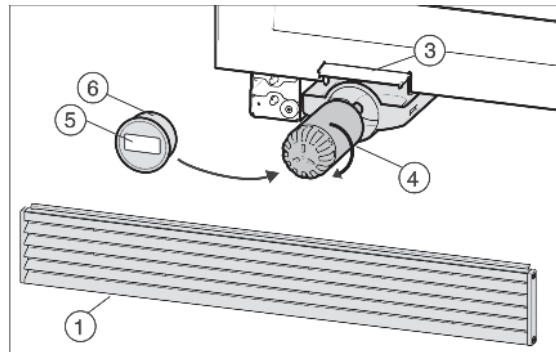

*Fig. 9*

- ▶ Insert the new filter *Fig. 9 (4)* and turn it about 100° clockwise as far as it will go.
- ▶ Place the cover *Fig. 9 (6)* on the filter.
- ▶ Write the date of the next filter replacement on the supplied adhesive label *Fig. 9 (5)* and affix it to the filter cover *Fig. 9 (6)*.
- ▶ Push in the water filter carriage *Fig. 9 (4)*.
- ▶ Close the filter change flap *Fig. 9 (3)*.
- ▶ Fit the ventilation grid *Fig. 9 (1)* again and push down. It must close flush with the floor.

#### Note

New water filters may contain particulate matter.

- ▶ Do not consume or use ice cubes produced within 72 hours after replacing the filter.
- ▶ Remove any ice still present in the IceMaker tray. You can keep this ice in another tray for later use.

- ▶ Make sure the filter does not leak and no water is coming out.

#### To reset the timer:

- ▶ Select setting mode: Press and hold the SuperFrost button *Fig. 2 (13)* for approx. 5 seconds.
- ▷ The SuperFrost button will flash
- ▷ **S** will appear on the display.
- ▶ Using the freezer compartment Up button *Fig. 2 (10)* or freezer compartment Down button *Fig. 2 (11)*, select **F**.
- ▶ To confirm: Briefly press the SuperFrost *Fig. 2 (13)* button.
- ▷ **F0** will appear on the display.
- ▶ To confirm: Briefly press the SuperFrost *Fig. 2 (13)* button.
- ▷ The filter symbol *Fig. 2 (7)* goes out

### 6.2 Defrosting with NoFrost

The NoFrost system defrosts the appliance automatically.

#### BioFresh compartment:



# Maintenance

The defrosted water is evaporated by the heat of the compressor.

- ▶ Clean the drain opening regularly so that the defrosted water can flow away (see 6.3) .

## Freezer compartment:

The moisture condenses on the evaporator and is periodically defrosted and evaporated.

- ▶ The appliance does not need to be defrosted manually.

## 6.3 Cleaning the appliance



### WARNING

Danger of electric shock.

- ▶ Unplug refrigerator or disconnect power.



### WARNING

Risk of injury or damage due to hot steam.

Hot steam can cause scalding/burns and damage to surfaces.

- ▶ Do not use steam cleaners.

### NOTICE

Incorrect cleaning damages the appliance.

- ▶ Do not use concentrated cleaning agents.
- ▶ Do not use steel wool or sponges that scour or scratch.
- ▶ Do not use caustic or abrasive cleaning materials or those containing sand, chloride, chemicals or acids.
- ▶ Do not use chemical solvents.
- ▶ Do not damage or remove the rating plate on the inside of the appliance. It is vital for the customer service department.
- ▶ Do not pull off, kink or damage any cables or other components.
- ▶ Do not let cleaning water get into the drain gutter, the ventilation grille and electrical parts.
- ▶ Use soft cleaning cloths and a multi-purpose cleaning agent with a neutral pH value.
- ▶ Only use food-compatible cleaning and care agents inside the appliance.

- ▶ **Empty the appliance.**
- ▶ **Disconnect the power plug.**



- ▶ Clean the **plastic surfaces, outside and inside**, by hand using lukewarm water and a little dish washing liquid.

Stainless steel which is exposed to chlorine gas or dampness may become discolored. This is normal. If your appliance is exposed to chlorine gas or dampness, clean and polish it more frequently. If there are any signs of rust or discoloration, clean and polish the appliance as soon as possible.\*

Do not apply stainless steel cleaning agents to glass or plastic surfaces so as not to scratch them. Initially darker areas and quite an intensive color of the stainless steel surfaces are normal.\*

- ▶ If dirty clean **external stainless steel surfaces** with a commercially available stainless steel cleaning agent. Then apply the supplied stainless steel cleaning agent evenly in the direction of the grain.\*

- ▶ To clean the **drain opening**: Remove deposits with a thin instrument, e.g. a cotton bud.

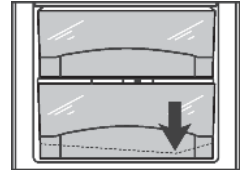

- ▶ Clean **fittings** by hand using lukewarm water and a little dish washing liquid.
- ▶ Clean the **telescopic rails** with a damp cloth only. The grease in the tracks is for lubrication purposes and should not be removed.

### After cleaning:

- ▶ Wipe the appliance and accessories dry.
- ▶ Connect the appliance and switch it on again.
- ▶ Switch on SuperFrost (see 5.8.4) .  
When the temperature is sufficiently cold:
- ▶ put the food back in the appliance.

## 6.4 Cleaning the IceMaker

The IceMaker drawer must be emptied and pushed in.

- ▶ Activate setting mode: press and hold the SuperFrost button *Fig. 2 (13)* for approximately 5 s.
  - ▷ 5 is shown on the display.
  - ▷ The Menu symbol *Fig. 2 (17)* lights up.
- ▶ Using the Freezer compartment Up button *Fig. 2 (10)*/ Freezer compartment Down button *Fig. 2 (11)*, select 1.
- ▶ To confirm: press the SuperFrost button *Fig. 2 (13)*.
- ▶ Using the Freezer compartment Up button *Fig. 2 (10)*/ Freezer compartment Down button *Fig. 2 (11)*, select **lc**.
- ▶ To confirm: press the SuperFrost button *Fig. 2 (13)*.
- ▷ The IceMaker moves into cleaning position and shuts off.
- ▶ Deactivate setting mode: press the Freezer compartment On/Off button *Fig. 2 (12)*.



-or-

- ▶ Wait 2 min.
  - ▷ The temperature is again displayed on the temperature display.
- ▶ Take out the drawer.
- ▶ Clean the ice compartment and drawer with warm water. If necessary, use a mild dishwashing liquid. Then rinse.
- ▶ Slide the drawer back in.  
If dishwashing liquid was used:
- ▶ Throw out the first three batches of ice cubes to get rid of any dishwashing liquid residues.

Either leave the IceMaker switched off in this position or switch the IceMaker back on (see 5.8.9) .

## 6.5 Customer service

First check whether you can remedy the fault yourself (see Troubleshooting). If this is not the case, please contact a qualified service provider.



### WARNING

Risk of injury from repairs by non-professionals.

- ▶ Repairs and work on the appliance and the power supply cable not described in the Manual (see Maintenance) should only be carried out by a qualified service provider.

- ▶ Read the appliance designation

*Fig. 10 (1)*, service no. *Fig. 10 (2)* and serial no. *Fig. 10 (3)* from the rating plate. The rating plate is located inside the appliance on the left-hand side.

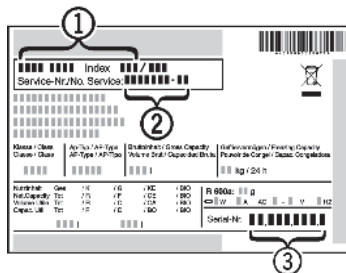

*Fig. 10*

- ▶ Notify a qualified service provider, specifying the fault, appliance designation *Fig. 10 (1)*, service no. *Fig. 10 (2)* and serial *Fig. 10 (3)* no.
- ▷ This will help us to provide you with a faster and more accurate service.

- ▶ Keep the appliance closed until the Customer Service engineer arrives.
- ▷ The food will stay cool longer.
- ▶ Disconnect the power plug (do not pull on the power cord to do this) or switch off the fuse.

## 6.6 Appliance Information

Make a note of this information when the appliance is installed:

Type Designation: \_\_\_\_\_  
 Service Number: \_\_\_\_\_  
 Appliance / Serial Number: \_\_\_\_\_  
 Date of purchase: \_\_\_\_\_  
 Where purchased: \_\_\_\_\_

## 7 Troubleshooting

Your appliance is designed and manufactured for reliable operation and a long lifespan. If a malfunction nonetheless occurs during operation, please determine if the malfunction is due to an operating error. If a service call determines operator error, you will be charged for the costs incurred, even during the warranty period. You may be able to rectify the following problems yourself:



Problem	Possible Cause	Correction
<b>The appliance does not work.</b>	The appliance is not switched on.	▶ Switch on the appliance.
	The power plug is not properly inserted in the wall socket.	▶ Check the power plug.
	The fuse in the wall socket is not OK.	▶ Check the fuse.
	Power failure	▶ Keep the appliance closed. ▶ Protect the food: place dry ice on top of the food or use an alternate freezer, if the power failure persists for some time. ▶ Do not re-freeze defrosted food.
<b>The compressor runs for a long time.</b>	When less refrigeration is required, the speed-controlled compressor switches to a low speed. Although the running time is increased as a result, energy is saved.	▶ This is normal in energy-saving models.
	SuperFrost function is activated.	▶ The compressor runs long to rapidly freeze food. This is normal.
	BioCool function is activated.	▶ The compressor runs long to rapidly cool food. This is normal.
<b>A LED at the lower rear of the</b>	The inverter is equipped with a diagnostic LED.	▶ The flashing is normal.

# Troubleshooting

Problem	Possible Cause	Correction
<b>appliance (for the compressor) flashes regularly every 15 seconds*.</b>		
<b>Noises are too loud.</b>	The different speed levels of speed-controlled* compressors can cause them to generate various noises during operation.	▶ These noises are normal.
<b>A gurgling sound</b>	This sound comes from the refrigerant flowing in the refrigeration circuit.	▶ The sound is normal.
<b>A faint clicking sound</b>	The sound always occurs when the refrigeration unit (the motor) automatically switches on or off.	▶ The sound is normal.
<b>A hum. It is briefly a little louder when the refrigeration unit (the motor) switches on.</b>	The refrigeration increases automatically when the SuperFrost function is activated, fresh food has just been placed in the appliance or the door has been left open for a while.	▶ The sound is normal.
	The refrigeration increases automatically when the BioCool function is activated, fresh food has just been placed in the appliance or the door has been left open for a while.	▶ The sound is normal.
	The ambient temperature is too high.	▶ Solution: (see 1.2)
<b>A low hum</b>	The sound occurs as a result of fan air flow.	▶ The sound is normal.
<b>Flow noise on the soft stop mechanism.</b>	The sound is caused by the soft stop mechanism.	▶ The sound is normal.
<b>The temperature display indicates: F0 to F9.</b>	There is a fault.	▶ Contact the customer service department (see Maintenance).
<b>The temperature display reads: FE</b>	There is a fault.	▶ Contact the customer service department (see Maintenance).
<b>The temperature display shows a flashing power failure symbol . The warmest temperature reached during the power failure is displayed in the temperature display.</b>	The freezer temperature rose too high during the last hours or days due to power failure or power interruption. When the power interruption is over, the appliance will continue to operate at the last temperature setting.	<ul style="list-style-type: none"> <li>▶ To delete the display of the warmest temperature: Press the Alarm button <i>Fig. 2 (14)</i>.</li> <li>▶ Check the quality of the food. Do not consume spoiled food. Do not re-freeze defrosted food.</li> </ul>

Problem	Possible Cause	Correction
<b>DEMO lights up in the temperature display.</b>	The demo mode is activated.	▶ Contact the customer service department (see Maintenance).
<b>The Filter Symbol Fig. 2 (7) lights up.</b>	The water filter should be replaced.	▶ Replace the water filter (see Maintenance).
<b>The outside surfaces of the appliance are hot*.</b>	The heat of the refrigerant circuit is used to prevent condensate from forming.	▶ This is normal.
<b>The IceMaker cannot be switched on.</b>	The appliance and therefore the IceMaker are not connected.	▶ Connect the appliance (see Start-up).
<b>The IceMaker is not making ice cubes.</b>	The IceMaker is not switched on.	▶ Switch the IceMaker on.
	The drawer of the IceMaker is not properly closed.	▶ Close the drawer properly.
	The water connection is not open.	▶ Open the water connection.
	The water supply to the IceMaker was interrupted.	▶ Check the connection to the water supply ( <b>see the Assembly Instructions, Connecting the Water Supply</b> ). ▶ Check the pipes and hoses ( <b>see the Assembly Instructions, Connecting the Water Supply</b> ).
	There is a blocked filter at the end of the water supply hose or at the connecting part on the machine.	▶ Clean the filters.
	The waterline was not bled of all air during installation	▶ Please contact your qualified installation plumber to ensure the above criteria is met before calling for service.
<b>The temperature is not cold enough.</b>	The door of the appliance is not closed properly.	▶ Close the appliance door.
	Insufficient ventilation.	▶ Clear ventilation grilles.
	The ambient temperature is too high.	▶ Solution: (see 1.2)
	The appliance was opened too frequently or for too long.	▶ Wait to see whether the required temperature resets itself by itself. If not, contact the customer service department (see Maintenance).
	Too much fresh food was placed inside without SuperFrost.	▶ Solution: (see 5.8.4)
	The temperature is incorrectly set.	▶ Set to a colder temperature and check after 24 hours
	The appliance is too near to a heat source (stove, heater etc).	▶ Change location of appliance or the heat source.
<b>Display show two dashes (“-”).</b>	The freezer temperature display will only show temperatures that are below freezing.	▶ When initially starting the appliance it will not be below freezing. It will take three to five hours (depending on ambient conditions) for freezing temperatures to be achieved and thus displayed numerically.

## Putting appliance out of service

Problem	Possible Cause	Correction
	The freezer temperature has risen above zero degrees due to a power failure or power interruption.	▶ See also “Power failure” and 
<b>The interior light is not on.</b>	The appliance is not switched on.	▶ Switch on the appliance.
	The door was open for longer than 15 minutes.	▶ The interior light automatically switches itself off if the door has been open for about 15 minutes.
	The LED interior light is faulty or the cover is damaged	 <b>WARNING</b> Risk of injury from electrical shock. Live parts are under the cover. ▶ The LED interior light should only be replaced or repaired by the Customer Service department or by engineers trained to do so.
		 <b>WARNING</b> Risk of injury from LED lamp! The lighting intensity of the LED light complies with laser class 1/1M. If the cover is faulty: ▶ Do not gaze directly at this lighting unit with optical lenses while very close to the light source. This can cause damage to your eyes.

## 8 Putting appliance out of service

### 8.1 Vacation Tips

**Short vacations:** If you will be away for less than four weeks

- ▶ Use all perishables.
- ▶ Freeze other items.
- ▶ Turn off the BioFresh compartment.
- ▶ Turn off the icemaker.
- ▶ Shut down the water supply to the icemaker.

**Long vacations:** If you will be away for a month or more

- ▶ Remove all food from the appliance.
- ▶ Turn OFF the appliance.
- ▶ Clean the appliance (see 6.3) .
- ▶ Leave the door open to prevent unpleasant odors.
- ▷ This will also keep mold from building up.
- ▶ Turn off the icemaker.
- ▶ Shut off the water supply to the icemaker.

### 8.2 Switching off the appliance

#### Note

- ▶ To switch off the entire appliance, only the freezer compartment needs to be switched off.

#### 8.2.1 Switching off the freezer compartment

- ▶ Press and hold down the freezer compartment On/Off button *Fig. 2 (12)* for approx. 2 seconds.
- ▷ The temperature displays are dark. The appliance is switched off.



#### 8.2.2 Switching off the Biofresh compartment

- ▶ Press and hold down the BioFresh compartment On/Off button *Fig. 2 (2)* for approx. 2 seconds.
- ▷ The BioFresh compartment temperature display *Fig. 2 (8)* is dark. The BioFresh compartment is switched off.

### 8.3 Decommissioning

- ▶ Empty the appliance.
- ▶ Put the IceMaker in the cleaning position (see Maintenance).
- ▶ Disconnect the power plug.
- ▶ Clean the appliance (see 6.3) .



- ▶ Leave the door open to prevent bad smells.



### 9 Disposing of the appliance

Follow the local regulations for the disposal of appliances. Old appliances can be dangerous. Contact the local refuse collection department for additional information.



#### **DANGER**

There is a risk of suffocation.

Children playing can shut themselves in and suffocate.

- ▶ Take the door(s) off.
- ▶ Remove the drawers.
- ▶ Leave the storage shelves in the appliance so that children cannot easily climb into the appliance.



#### **WARNING**

Danger of electric shock.

- ▶ Cut off the plug from the power cord and discard.
- ▶ Cut off the power cord from the discarded appliance. Dispose of separately from the appliance.

Ensure during and after disposal that the appliance isn't stored in the vicinity of gasoline or other flammable vapors and liquids.

When disposing of the appliance, ensure that the refrigeration circuit is not damaged to prevent uncontrolled escape of the refrigerant it contains (data on type plate) and oil.

### 10 Liebherr Warranty Plan

**FULL TWO YEAR WARRANTY** - For two years from the date of original purchase, your Liebherr warranty covers all parts and labor to repair or replace any part of the product which proves to be defective in materials or workmanship.

**FULL FIVE YEAR WARRANTY** - For five years from the date of original purchase, your Liebherr warranty covers all parts and labor to repair or replace any components that prove to be defective in materials or workmanship in the sealed system. The "Sealed System" means only the compressor, condenser, evaporator, drier and all connecting tubing.

**LIMITED 6TH THROUGH 12TH YEAR WARRANTY** - From the 6<sup>th</sup> through 12<sup>th</sup> year from the date of original purchase, your Liebherr warranty covers all parts that prove to be defective in materials or workmanship in the Sealed System (parts only).

#### **TERMS APPLICABLE TO EACH WARRANTY**

All service provided by Liebherr under the warranty must be performed by authorized Liebherr service representatives, unless otherwise specified by Liebherr. Service will be provided in the home during normal business hours. This warranty applies only to products installed for normal residential use. Details regarding a non-residential warranty are available on request.

The warranty applies only to products installed in any one of the fifty states of the United States or the District of Columbia. The warranty does not cover any parts or labor to correct any defect caused by negligence, accident or improper use, maintenance, installation, service or repair, including but not limited to improper removal and reinstallation of the condensing unit.

**THE WARRANTIES DESCRIBED ABOVE ARE MADE EXPRESSLY IN LIEU OF ANY OTHER WARRANTIES, EXPRESSED OR IMPLIED, INCLUDING ANY IMPLIED WARRANTY OF MERCHANTABILITY OR FITNESS FOR A PARTICULAR PURPOSE, AND OF ANY OTHER OBLIGATION OR LIABILITY ON THE PART OF LIEBHERR. IN NO EVENT SHALL LIEBHERR BE LIABLE FOR SPECIAL, INCIDENTAL OR CONSEQUENTIAL DAMAGES ARISING FROM THE BREACH OF THESE WARRANTIES OR ANY OTHER WARRANTIES, WHETHER EXPRESS, IMPLIED OR STATUTORY.**

Some states do not allow the exclusion or limitation of incidental or consequential damages so the above limitation or exclusion may not apply to you. This warranty gives you specific legal rights and you may also have other legal rights which vary from state to state.

To receive parts and/or service and the name of the Liebherr authorized service representative nearest you, contact your Liebherr dealer or distributor or contact the Liebherr designated national service provider:

in the US: [Service-appliances.us@liebherr.com](mailto:Service-appliances.us@liebherr.com) or call 1-866-LIEBHER (1-866-543-2437).

in Canada: [www.euro-parts.ca](http://www.euro-parts.ca) or call 1-888-LIEBHER (1-888-543-2437).

**For Service in the U.S.:**

**Liebherr Service Center**

**Toll Free: 1-866-LIEBHER or 1-866-543-2437**

Service-appliances.us@liebherr.com  
PlusOne Solutions, Inc.  
3501 Quadrangle Blvd, Suite 120  
Orlando, FL 32817

**For Service in Canada:**

**Liebherr Service Center**

**Toll Free: 1-888-LIEBHER or 1-888-543-2437**

www.euro-parts.ca  
EURO-PARTS CANADA  
39822 Belgrave Road  
Belgrave, Ontario, N0G 1E0  
Phone: (519) 357-3320  
Fax: (519) 357-1326

**[www.liebherr-appliances.com](http://www.liebherr-appliances.com)**