



20" and 24" Compact Electric Ranges

Safety Instructions 2-6

Operating Instructions

Oven 8-11
Surface Units 7

Care and Cleaning

Aluminum Foil 8
Cooktop 12, 13
Knobs 14
Oven Door 13
Oven Heating Elements 13
Oven Interior 14
Painted Surfaces 14
Shelves 12
Surface Units and Drip Pans 12

Installation Instructions

Anti-Tip Device 15, 21
Dimensions and Clearances 16
Electrical Connections 17-20
Flooring 16
Leveling 22
Preparation 16
Tools You Will Need 16

Troubleshooting Tips 22

Warranty 23

**Owner's Manual and
Installation Instructions**

RE201W
RE241W

Write the model and serial numbers here:

Model # _____

Serial # _____

You can find them on a label under the cooktop. See the Lift-Up Cooktop section in this manual for instructions on how to lift the cooktop.

IMPORTANT SAFETY INFORMATION. READ ALL INSTRUCTIONS BEFORE USING.

⚠ WARNING

Read all safety instructions before using the product. Failure to follow these instructions may result in fire, electric shock, serious injury or death.

ANTI-TIP DEVICE



⚠ WARNING
Tip-Over Hazard
A child or adult can tip the range and be killed. Verify the anti-tip bracket has been properly installed and engaged to the floor or wall. Ensure the anti-tip bracket is re-engaged when the range is moved by sliding the anti-tip arm just under the bracket. Do not operate the range without the anti-tip bracket in place and engaged. Failure to follow these instructions can result in death or serious burns to children or adults.

To reduce the risk of tipping the range, the range must be secured by a properly installed anti-tip bracket. See installation instructions shipped with the bracket for complete details before attempting to install.

For Freestanding Ranges

To check if the bracket is installed and engaged properly, look underneath the range to see that the anti-tip arm attached to the

side panel is engaged in the bracket. On some models, the storage drawer or kick panel can be removed for easier inspection. If visual inspection is not possible, slide the range forward, confirm the anti-tip bracket is securely attached to the floor or wall, and slide the range back so the anti-tip arm slides just under the anti-tip bracket. If the range is pulled from the wall for any reason, always repeat this procedure to verify the range is properly secured by the anti-tip bracket.

If you did not receive an anti-tip bracket with your purchase, call 1-800-932-4267 toll-free to receive one at no cost.

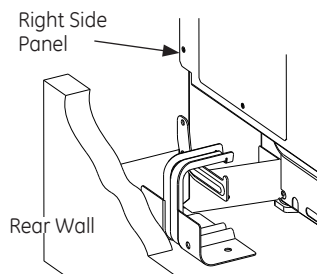
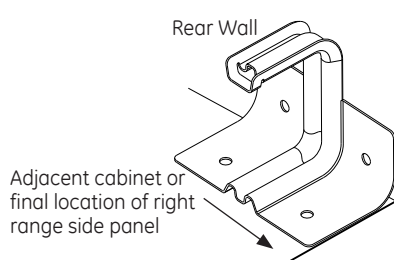

⚠ WARNING

IMPORTANT SAFETY NOTICE

The California Safe Drinking Water and Toxic Enforcement Act requires the Governor of California to publish a list of substances known to the state to cause cancer, birth defects or other reproductive harm, and requires businesses to warn customers of potential exposure to such substances.

The fiberglass insulation in self-clean ovens gives off a very small amount of carbon monoxide during the cleaning cycle. Exposure can be minimized by venting with an open window or using a ventilation fan or hood.

⚠ WARNING**GENERAL SAFETY INSTRUCTIONS**

- Use this appliance for its intended purpose as described in this Owner's Manual.
- Be sure your appliance is properly installed and grounded by a qualified installer in accordance with the provided installation instructions.
- Do not attempt to repair or replace any part of your range unless it is specifically recommended in this manual. All other servicing should be referred to a qualified technician.
- Before performing any service, unplug the range or disconnect the power supply at the household distribution panel by removing the fuse or switching off the circuit breaker.
- Do not leave children alone—children should not be left alone or unattended in an area where an appliance is in use. They should never be allowed to climb, sit or stand on any part of the appliance.
- **CAUTION:** Do not store items of interest to children above a range or on the backguard of a range—children climbing on the range to reach items could be seriously injured.
- Use only dry pot holders—moist or damp pot holders on hot surfaces may result in burns from steam. Do not let pot holders touch hot surface units or heating elements. Do not use a towel or other bulky cloth in place of pot holders.
- Never use your appliance for warming or heating the room.
- Do not touch the surface units, the heating elements or the interior surface of the oven. These surfaces may be hot enough to burn even though they are dark in color. During and after use, do not touch, or let clothing or other flammable materials contact the surface units, areas nearby the surface units or any interior area of the oven; allow sufficient time for cooling first. Other surfaces of the appliance may become hot enough to cause burns. Potentially hot surfaces include the cooktop, areas facing the cooktop, oven vent opening, surfaces near the opening and crevices around the oven door.
- Do not heat unopened food containers. Pressure could build up and the container could burst, causing an injury.
- Do not use aluminum foil to line drip pans or anywhere in the oven, except as described in this manual. Foil can trap heat or melt, resulting in damage to the product and a shock or fire hazard.
- Avoid scratching or impacting glass doors, cook tops or control panels. Doing so may lead to glass breakage. Do not cook on a product with broken glass. Shock, fire or cuts may occur.
- Cook meat and poultry thoroughly—meat to at least an internal temperature of 160°F and poultry to at least an internal temperature of 180°F. Cooking to these temperatures usually protects against foodborne illness.

⚠ WARNING**KEEP FLAMMABLE MATERIALS AWAY FROM THE RANGE.**

- Do not store or use flammable materials in an oven or near the cooktop, including paper, plastic, pot holders, linens, wall coverings, curtains, drapes and gasoline or other flammable vapors and liquids.
- Never wear loose-fitting or hanging garments while using the appliance. These garments may ignite if they contact hot surfaces causing severe burns.
- Do not let cooking grease or other flammable materials accumulate in or near the range. Grease in the oven or on the cooktop may ignite.
- Clean ventilating hoods frequently. Grease should not be allowed to accumulate on the hood or filter.

IMPORTANT SAFETY INFORMATION. READ ALL INSTRUCTIONS BEFORE USING.

⚠ WARNING *IN THE EVENT OF A FIRE, TAKE THE FOLLOWING STEPS TO PREVENT THE FIRE FROM SPREADING:*

- Do not use water on grease fires. Never pick up a flaming pan. Turn the controls off. Smother a flaming pan on a surface unit by covering the pan completely with a well-fitting lid, cookie sheet or flat tray. Use a multi-purpose dry chemical or foam-type fire extinguisher.
- If there is a fire in the oven during baking, smother the fire by closing the oven door and turning the oven off or by using a multi-purpose dry chemical or foam-type fire extinguisher.
- If there is a fire in the oven during self-clean, turn the oven off and wait for the fire to go out. Do not force the door open. Introduction of fresh air at self-clean temperatures may lead to a burst of flame from the oven. Failure to follow this instruction may result in severe burns.

⚠ WARNING *COOKTOP SAFETY INSTRUCTIONS*

- Never leave the surface units unattended at medium or high heat settings. Boilovers cause smoking and greasy spillovers that may catch on fire.
- Never leave oil unattended while frying. If allowed to heat beyond its smoking point, oil may ignite resulting in fire that may spread to surrounding cabinets. Use a deep fat thermometer whenever possible to monitor oil temperature.
- To avoid oil spillover and fire, use a minimum amount of oil when shallow pan-frying and avoid cooking frozen foods with excessive amounts of ice.
- Use proper pan size—select cookware having flat bottoms large enough to cover the surface heating element. The use of undersized cookware will expose a portion of the surface unit to direct contact and may result in ignition of clothing. Proper relationship of cookware to surface unit will also improve efficiency.
- Only certain types of glass, glass/ceramic, earthenware or other glazed containers are suitable for cooktop service; others may break because of the sudden change in temperature.
- To minimize the possibility of burns, ignition of flammable materials and spillage, the handle of a container should be turned toward the center of the range without extending over nearby surface units.
- When preparing flaming foods under a hood, turn the fan on.
- If power is lost to an electric cooktop while a surface unit is ON, the surface unit will turn back on as soon as power is restored. In the event of power loss, failure to turn all surface unit knobs to the OFF position may result in ignition of items on or near the cooktop, leading to serious injury or death.

▲ WARNING**RADIANT COOKTOP SAFETY INSTRUCTIONS**

(Some models)

- Use care when touching the cooktop. The glass surface of the cooktop will retain heat after the controls have been turned off.
- Do not cook on a broken cooktop. If glass cooktop should break, cleaning solutions and spillovers may penetrate the broken cooktop and create a risk of electric shock. Contact a qualified technician immediately.
- Avoid scratching the glass cooktop. The cooktop can be scratched with items such as knives, sharp instruments, rings or other jewelry, and rivets on clothing.
- Do not place or store items that can melt or catch fire on the glass cooktop, even when it is not being used. If the cooktop is inadvertently turned on, they may ignite. Heat from the cooktop or oven vent after it is turned off may cause them to ignite also.
- Use CERAMA BRYTE® ceramic Cooktop Cleaner and CERAMA BRYTE® Cleaning Pad to clean the cooktop. Wait until the cooktop cools and the indicator light goes out before cleaning. A wet sponge or cloth on a hot surface can cause steam burns. Some cleaners can produce noxious fumes if applied to a hot surface. Note: Sugar spills are an exception. They should be scraped off while still hot using an oven mitt and a scraper. See the Cleaning the glass cooktop section for detailed instructions.
- Read and follow all instructions and warnings on the cleaning cream label.

▲ WARNING**COIL COOKTOP SAFETY INSTRUCTIONS**

(Some models)

- Do not immerse or soak the removable surface units. Do not put them in a dishwasher. Do not self-clean the surface units in an oven. Doing so may cause them to fail presenting a burn or fire hazard.
- To avoid the possibility of a burn or electric shock, always be certain that the controls for all surface units are at the OFF position and all coils are cool before attempting to lift or remove a coil surface unit.
- Be sure the drip pans are not covered and are in place. Their absence during cooking could damage range parts and wiring.
- Do not use aluminum foil to line drip pans. Foil can trap heat or melt, resulting in damage to the product and a shock or fire hazard.

▲ WARNING**OVEN SAFETY INSTRUCTIONS**

-
- Stand away from the range when opening the oven door. Hot air or steam which escapes can cause burns to hands, face and/or eyes.
 - Keep the oven vent unobstructed.
 - Keep the oven free from grease buildup. Grease in the oven may ignite.
 - Place oven racks in desired location while oven is cool. If rack must be moved while oven is hot, do not let pot holder contact hot heating element in oven.
 - When using cooking or roasting bags in the oven, follow the manufacturer's directions.
 - Pull the oven rack to the stop-lock position when loading and unloading food from the oven. This helps prevent burns from touching hot surfaces of the door and oven walls.
 - Do not leave items such as paper, cooking utensils or food in the oven when not in use. Items stored in an oven can ignite.
 - Do not use aluminum foil to line the oven bottom. Foil can trap heat or melt, resulting in damage to the product and a shock or fire hazard.

IMPORTANT SAFETY INFORMATION. READ ALL INSTRUCTIONS BEFORE USING.

⚠ WARNING

SELF-CLEANING OVEN SAFETY INSTRUCTIONS

(Some models)

The self-cleaning feature operates the oven at temperatures high enough to burn away food soils in the oven. Follow these instructions for safe operation.

- Before operating the self-clean cycle, remove pans, shiny metal oven racks and other utensils from the oven. Only gray or black porcelain-coated oven racks and drip pans may be left in the oven. Do not use self-clean to clean other parts, such as shiny drip pans or bowls.
- Before operating the self-clean cycle, wipe grease and food soils from the oven. Excessive amount of grease may ignite leading to smoke damage to your home.
- If the self-cleaning mode malfunctions, turn the oven off and disconnect the power supply. Have it serviced by a qualified technician.
- Do not clean the door gasket. The door gasket is essential for a good seal. Care should be taken not to rub, damage or move the gasket.
- Do not use oven cleaners. No commercial oven cleaner or oven liner protective coating of any kind should be used in or around any part of the oven.

⚠ WARNING

WARMING DRAWER/LOWER OVEN DRAWER SAFETY INSTRUCTIONS *(Some models)*

- The purpose of the warming drawer is to hold hot cooked foods at serving temperature. Bacteria will grow in food while it is below 140°F. Do not put cold food in warming drawer. Do not heat food for more than 2 hours. Failure to follow these instructions may result in foodborne illness.
- Do not leave paper products, plastics, canned food or combustible materials in the drawer. They may ignite.
- Do not touch the heating element or the interior surface of the drawer. These surfaces may be hot enough to cause burns.
- Use care when opening the drawer. Open the drawer a crack and let hot air or steam escape before removing or replacing food. Hot air or steam that escapes can cause burns to hands, face and/or eyes.
- Do not use aluminum foil to line the lower drawer. The foil will trap heat below, and upset the performance of the oven. Foil can melt and permanently damage the drawer bottoms.

**READ AND FOLLOW THIS SAFETY INFORMATION CAREFULLY.
SAVE THESE INSTRUCTIONS**

Using the surface units.

Throughout this manual, features and appearance may vary from your model.

Surface Cooking Controls

Your surface units and controls are designed to give you a variety of heat settings for surface unit cooking.

At both **LO** and **HI** positions, there is a slight niche so control **clicks** at those positions; **HI** marks the highest setting; **LO**, the lowest setting.

In a quiet kitchen, you may hear slight **clicking** sounds during cooking, indicating heat settings selected are being maintained.

Switching heats to higher settings always shows a quicker change in temperature than switching to lower settings.

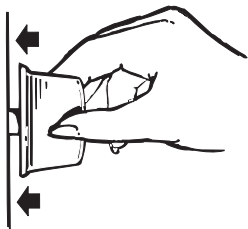

How to Set the Controls

- 1 Push the control knob in.
- 2 Turn either clockwise or counterclockwise to desired heat setting.

Control must be pushed in to set only from the **OFF** position.

When control is in any position other than **OFF**, you can turn it without pushing in.

Be sure you turn control to **OFF** when you finish cooking. An indicator light will glow when **ANY** surface unit is on.

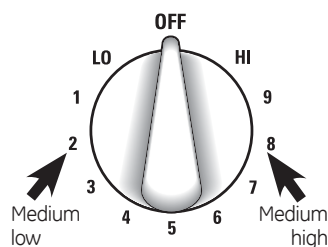

Heat Setting Guide

HI – Quick start for cooking; bring water to boil.

MEDIUM HIGH – Fast fry, pan broil; maintain fast boil on large amount of food.

MED – Saute and brown; maintain slow boil on large amount of food.

MEDIUM LOW – Cereal; maintain serving temperature of most foods.

LO – Cook after starting at HI; cook with little water in covered pan. Use to steam rice.

NOTE:

- 1 At **HI** or **MEDIUM HIGH**, never leave food unattended. Boilovers cause smoking; greasy spillovers may catch fire.
- 2 At **LO**, melt chocolate, butter on small unit.

Cooking Tips

- Use medium- or heavyweight cookware. Aluminum cookware conducts heat faster than other metals. Cast-iron and coated cast-iron cookware is slow to absorb heat, but generally cooks evenly at low or medium heat settings. Steel pans may cook unevenly if not combined with other metals.
- Do not overfill cookware with fat that may spill over when adding food. Frosty foods bubble vigorously. Watch foods frying at high temperatures. Keep range and hood clean from accumulated grease.
- To conserve the most cooking energy, pans should be flat on the bottom, have straight sides and tight-fitting lids. Match the size of the saucepan to the size of the surface unit. A pan that extends more than an inch beyond the edge of the drip pan traps heat, which causes "crazing" (fine hairline cracks) on porcelain, and discoloration ranging from blue to dark gray on chrome drip pans.

Using the oven.

The OVEN TEMP knob is located on the control panel on the front of the range.

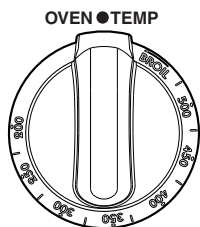

Oven Temperature Control

To use the oven, simply turn the knob to the desired cooking temperatures, which are marked in 25°F increments on the dial. **OVEN TEMP** maintains the temperature you set, from 200°F to **BROIL**.

The Oven Cycling Light glows until the oven reaches your selected temperature, then goes off and on with the oven unit(s) during cooking.

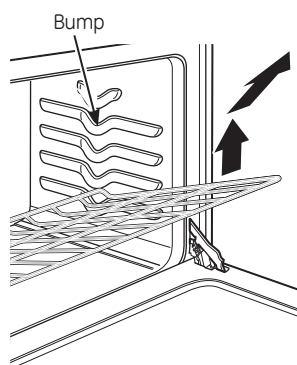

Oven Shelves

The shelves are designed with stop-locks so when placed correctly on the shelf supports, they will stop before coming completely out of the oven and will not tilt when you are removing food from them or placing food on them.

When placing cookware on a shelf, pull the shelf out to the bump on the shelf support. Place the cookware on the shelf, then slide the shelf back into the oven. This will eliminate reaching into the hot oven.

To remove the shelves from the oven, pull them toward you, tilt front end upward and pull them out.

To replace, place shelf on shelf support with stop-locks (curved extension of shelf) facing up and toward back of oven. Tilt up front and push shelf toward back of oven until it goes past the bump on the shelf support. Then lower front of shelf and push it all the way back.

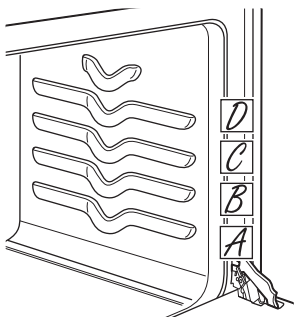

Oven Shelf Positions

The oven has four shelf supports—**A** (bottom), **B**, **C** and **D** (top).

Shelf positions for cooking are suggested on Baking and Roasting pages.

The oven has 4 shelf positions.

Use of Aluminum Foil

Do not use aluminum foil to line oven bottoms. The foil will trap heat below and upset the performance of the oven. Foil can melt and permanently damage the oven bottom. Damage from improper use of aluminum foil is not covered by the product warranty.

Foil may be used to catch spills by placing a sheet on a lower rack, several inches below the food. Do not use more foil than necessary and never entirely cover an oven rack with aluminum foil. Keep foil at least 1-1/2" from oven walls to prevent poor heat circulation.

Using the oven for baking or roasting.

To avoid possible burns, place the shelves in the desired position before you turn the oven on.

How to Set Your Oven for Baking or Roasting

- 1 Position the shelf or shelves in the oven. If cooking on two shelves at the same time, stagger the pans for best heat circulation.
- 2 Close oven door. Turn **OVEN TEMP** knob clockwise to desired temperature. Preheat oven for at least 10 minutes if preheating is necessary.
- 3 Place food in oven on center of shelf. Allow at least 2 inches between edge of bakeware and oven wall or adjacent cookware.
- 4 Check food for doneness at minimum time on recipe. Cook longer if necessary. Turn **OVEN TEMP** knob to **OFF** and remove food.

Shelf Positions

- Most baking is done on the second shelf position (**B**) or the third shelf position (**C**) from the bottom.
- When baking three or four items, use two shelves positioned on the second and fourth sets of supports (**B & D**) from bottom of oven.
- Bake angel food cakes on first shelf position (**A**) from bottom of oven.
- Roasting is usually done on the bottom shelf position (**A**).

Preheating

- Preheating the oven takes about 10 minutes.
- Preheat the oven only when necessary, usually for baking.
- Most roasts will cook satisfactorily without preheating.
- If you find preheating is necessary, keep an eye on the Oven Cycle light and put food in the oven promptly after the light goes out. The Oven Cycle light will then cycle on and off with the oven thermostat as it cycles to maintain oven temperature.

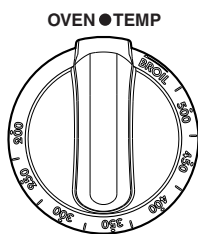

Baking and Roasting Tips

- Follow a tested recipe and measure the ingredients carefully. If you are using a package mix, follow label directions.
- Do not open the oven door during a baking operation—heat will be lost and the baking time might need to be extended. This could cause poor baking results. If you must open the door, open it partially—only 3 or 4 inches—and close it as quickly as possible.
- Roasting is cooking by dry heat. Tender meat or poultry can be roasted uncovered in your oven. Roasting temperatures, which should be low and steady, keep spattering to a minimum. When roasting, it is not necessary to sear, baste, cover or add water to your meat.
- Frozen roasts of beef, pork, lamb, etc., can be started without thawing, but allow 10 to 25 minutes per pound additional time (10 minutes per pound for roasts under 5 pounds, more time for larger roasts).
- Thaw most frozen poultry before roasting to ensure even doneness. Some commercial frozen poultry can be cooked successfully without thawing. Follow directions given on package label.

Adjust the oven thermostat—Easy to do yourself!

You may find that your new oven cooks differently than the one it replaced. Use your new oven for a few weeks to become more familiar with it. If you still think your new oven is too hot or too cold, you can adjust the thermostat yourself.

Do not use thermometers, such as those found in grocery stores, to check the temperature setting of your oven. These thermometers may vary 20–40°F.

NOTE: This adjustment will not affect the broiling temperatures. The adjustment will be retained after a power failure.

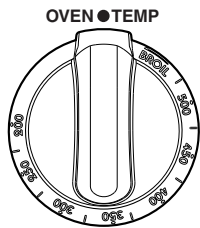

Front of OVEN TEMP knob
(knob appearance may vary)

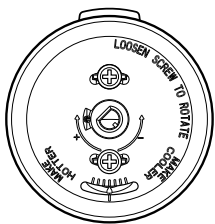

Back of OVEN TEMP knob

To Adjust the Thermostat with this Type of Knob

- 1 Pull the OVEN TEMP knob off the range and look at the back side.**
To make an adjustment, loosen (approximately one turn), but do not completely remove, the two screws on the back of the knob.
- 2** With the back of the knob facing you, hold the outer edge of the knob with one hand and turn the front of the knob with the other hand.

To increase the oven temperature, move the top screw toward the right. You'll hear a click for each notch you move the knob.

To decrease the oven temperature, move the top screw toward the left.

Each click will change the oven temperature approximately 10°F. (Range is plus or minus 60°F from the arrow.) We suggest that you make the adjustment one click from the original setting and check oven performance before making any additional adjustments.

- 3 After the adjustment is made,** retighten screws so they are snug, but be careful not to overtighten.
- 4** Replace the knob, matching the flat area of the knob to the shaft, and check performance.

The type of margarine will affect baking performance!

Most recipes for baking have been developed using high-fat products such as butter or margarine (80% fat). If you decrease the fat, the recipe may not give the same results as with a higher fat product.

Recipe failure can result if cakes, pies, pastries, cookies or candies are made with low-fat spreads. The lower the fat content of a spread product, the more noticeable these differences become.

Federal standards require products labeled "margarine" to contain at least 80% fat by weight. Low-fat spreads, on the other hand, contain less fat and more water. The high moisture content of these spreads affects the texture and flavor of baked goods. For best results with your old favorite recipes, use margarine, butter or stick spreads containing at least 70% vegetable oil.

Using the oven for broiling.

Broiling may be slightly different from any previous broiling you may be acquainted with, so be sure to read this section completely.

How to Set Your Oven for Broiling

Broiling is cooking food by intense radiant heat from the upper element in the oven. Most fish and tender cuts of meat can be broiled. Follow these steps to keep spattering and smoking to a minimum.

- 1 If the meat has fat or gristle around the edge, cut vertical slashes through both about 2" apart. If desired, fat may be trimmed, leaving a layer about 1/8" thick.
- 2 Place the meat on a broiler grid in a broiler pan designed for broiling. Always use the grid so the fat drips into the broiler pan; otherwise the juices may become hot enough to catch fire.
- 3 Place the shelf in position **C** (see page 8) for most broiling.
- 4 Close the door. **Always broil with the door closed.**
- 5 Turn the **OVEN TEMP** knob clockwise to **BROIL**. You will feel a slight niche at the broil position.
- 6 Turn food only once during cooking.
- 7 Turn the **OVEN TEMP** knob to **OFF**. Serve food immediately, and leave the pan outside the oven to cool during the meal for easiest cleaning.

Broiling Guide

- If desired, marinate meats or chicken before broiling, or brush with barbecue sauce the last 5 to 10 minutes only.
- Frozen steaks can be broiled by positioning the oven shelf at the next lowest shelf position and increasing cooking time given in this guide 1½ times per side.
- When arranging food on pan, do not let fatty edges hang over sides because the dripping fat will soil the oven.
- If your range is connected to 208 volts, rare steaks may be broiled by preheating the broiler and positioning the oven shelf one position higher.

Food	Amount or Thickness	Shelf Position	Time In Minutes		Comments
			First Side	Second Side	
Bacon	1/2 lb. (about 8 thin slices)	C	3½ min.	3½ min.	Arrange in single layer.
Ground Beef	1 lb. (4 patties) 1/2 to 3/4" thick	C	10 min.	7 min.	Space evenly.
Beef Steaks Medium	1" thick 1 to 1½ lbs.	C	9 min.	9 min.	Steaks less than 1" thick cook through before browning. Pan frying is recommended. Slash fat.
Chicken	1 whole 2 to 2½ lbs., split lengthwise	A	35 min.	15 min.	Reduce time about 5 to 10 minutes per side for cut-up chicken. Brush each side with melted butter. Broil skin-side-down first.
Fish	1 lb. fillets 1/4 to 1/2" thick	C	5 min.	5 min.	Handle and turn very carefully. Brush with lemon butter before and during cooking, if desired. Preheat broiler to increase browning.

Care and cleaning of the range.

Be sure electrical power is off and all surfaces are cool before cleaning any part of the range.

Proper care and cleaning are important so your range will give you efficient and satisfactory service. Follow these directions carefully in caring for your range to assure safe and proper maintenance.

	⚠ WARNING
	Tip-Over Hazard A child or adult can tip the range and be killed. Verify the anti-tip bracket has been properly installed and engaged to the floor or wall. Ensure the anti-tip bracket is re-engaged when the range is moved by sliding the anti-tip arm just under the bracket. Do not operate the range without the anti-tip bracket in place and engaged. Failure to follow these instructions can result in death or serious burns to children or adults.

Porcelain Enamel Cooktop

The porcelain enamel finish is sturdy but breakable if misused. This finish is acid-resistant. However, any acidic foods spilled (such as fruit juices, tomato or vinegar) should not be permitted to remain on the finish.

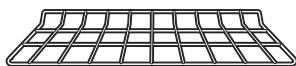

Oven Shelves

Clean the shelves with an abrasive cleanser or steel wool.

After cleaning, rinse the shelves with clean water and dry with a clean cloth.

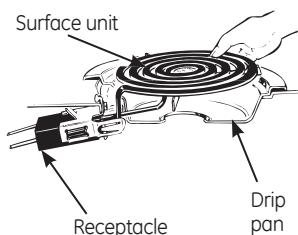

To remove the surface unit, lift it about 1 inch above the drip pan and pull it out.



Replace the drip pan into the recess in the cooktop.

Surface Units and Drip Pans

To clean the surface units, turn the control to the highest setting for a minute. The coils will burn off any soil.

To remove a surface unit:

To remove the drip pans for cleaning, the surface units must be removed first. Make sure the surface units are cool before touching them.

Lift the surface unit about 1" above the drip pan and pull it out.

Do not lift the surface unit more than 1". If you do, it may not lie flat on the drip pan when you plug it back in.

NOTE: Repeated lifting of the surface unit more than 1 inch above the drip pan can permanently damage the receptacle.

To replace a surface unit:

Replace the drip pan into the recess in the cooktop. Make sure the opening in the pan lines up with the receptacle.

Insert the terminals of the surface unit through the opening in the drip pan and into the receptacle.

Guide the surface unit into place so it rests evenly.

To clean the drip pans:

Drip pans can be cleaned in the dishwasher or by hand. If you use a scouring pad, rub lightly to prevent scratching.

Q Can I cover the drip pans with foil?

A No, because using foil so close to the receptacle could cause shock, fire or damage to the range.

CAUTION:

- Do not immerse the surface units in liquids of any kind.
- Do not clean the surface units in a dishwasher.
- Do not bend the surface unit plug terminals.
- Do not attempt to clean, adjust or in any way repair the plug-in receptacle.

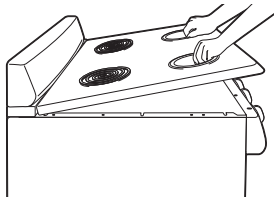

Lift-Up Cooktop

Clean the area under the cooktop often. Built-up soil, especially grease, may catch on fire.

To make cleaning easier, the cooktop may be lifted up and propped open.

Be sure all surface units are turned off before raising the cooktop.

Remove the front surface and drip pans. See the Surface Units and Drip Pans section. Grasp the two front surface unit wells and lift the cooktop up and prop it open with the prop rod provided.

After cleaning underneath the cooktop with hot, soapy water and a clean cloth, hold the cooktop up, return the prop rod to its storage position and lower the cooktop until it snaps into position. Be careful not to pinch your fingers. Replace the two front drip pans and surface units. See the Surface Units and Drip Pans section.

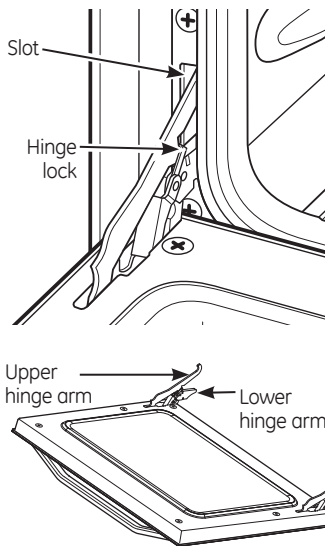

Lift-Off Oven Door

The oven door is removable, but it is heavy. You may need help removing and replacing the door.

To remove the door:

- 1 Open the door to the full open position.
- 2 Pull the hinge locks up over the hinge hooks on both sides.
- 3 Grasp the door firmly on each side, lift slightly and pull it straight out and away from the oven.

To replace the door:

- 1 Firmly grasp both sides of the door at the top.
- 2 Insert and seat the upper and lower hinge arms into the oven slots.
- 3 Push the hinge locks down from the hinge hooks.
- 4 Close the oven door and make sure it is working properly. If it is not working properly, remove and replace it following the above steps.

DO NOT ATTEMPT TO CLOSE THE DOOR UNTIL THIS STEP IS COMPLETE. THE HINGE OR DOOR COULD BE DAMAGED.

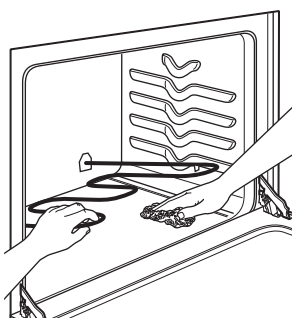

Oven Heating Elements

Do not clean the bake element or the broil element. Any soil will burn off when the elements are heated.

The bake element can be lifted gently to clean the oven floor. Do not attempt to clean any oven surface when any burner element is on. Always wear protective hand-wear when cleaning interior oven surfaces or surfaces near

heating elements. If spillovers, residue or ash accumulate around the bake element, gently wipe around the element with warm water.

Glass Window *(on some models)*

To clean the outside glass finish, use a glass cleaner. Rinse and polish with a dry cloth.

Care and cleaning of the range.

Control Knobs

The control knobs may be removed for easier cleaning.

Make sure the knobs are in the **OFF** positions and pull them straight off the stems for cleaning.

The knobs can be cleaned in a dishwasher or they may also be washed with soap and water. Make sure the insides of the knobs are dry before replacing.

Replace the knobs in the **OFF** position to ensure proper placement.

Painted Surfaces

Painted surfaces include the sides, control panel, door and kick panel. Clean these with soap and water or a vinegar and water solution.

Do not use commercial oven cleaners, cleansing powders, steel wool or harsh abrasives on any painted surface.

Porcelain Oven Interior

With proper care, the porcelain enamel interior will retain its attractive finish for many years.

Soap and water will normally do the job. Heavy spattering or spillovers may require cleaning with a mild abrasive cleanser. Soapy, wet pads may also be used. Do not allow food spills with a high sugar or acid content (such as milk, tomatoes, sauerkraut, fruit juices or pie filling) to remain on the surface. They may cause dull spots even after cleaning.

Household ammonia may make the cleaning job easier. Place 1/2 cup ammonia in a shallow glass pan and leave in a cold oven overnight. The ammonia fumes will help loosen the burned-on grease and food.

When necessary, you may use a commercial oven cleaner. Follow the package directions.

Cautions about using spray-on oven cleaners:

- Do not spray the oven cleaner on the electrical controls and switches because it could cause a short circuit and result in sparking or fire.
 - Do not directly spray oven cleaner onto the oven heating elements.
 - Do not allow a film from the cleaner to remain on the temperature sensor—it could cause the oven to heat improperly. (The sensor is located at the top of the oven.) Carefully wipe the bulb clean after each oven cleaning, being careful not to move the sensor since a change in its position could affect how the oven bakes.
 - Do not spray any oven cleaner on the outside oven door, handles or any exterior surface of the oven, cabinet or painted surfaces. The cleaner can damage these surfaces.
-

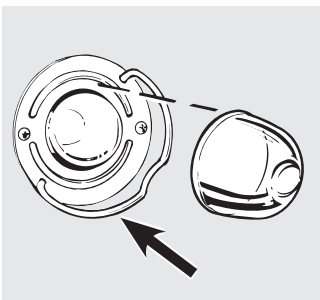

Wire cover holder

Oven Light Replacement (on some models)

Be sure to let the light cover and bulb cool completely.

To remove the cover:

- 1 Hold a hand under the cover so it doesn't fall when released. With fingers of the same hand, firmly push back the wire cover holder. Lift off the cover.

Do not remove any screws to remove the cover.

- 2 Replace bulb with a 40-watt appliance bulb.

To replace the cover:

- 1 Place it into groove of the light receptacle. Pull wire forward to the center of the cover until it snaps into place.
- 2 Connect electrical power to the range.

Installation Instructions

20" and 24" Compact Electric Ranges

? Questions? Call 1-800-932-4267 or Visit our Website at: www.summitappliance.com

BEFORE YOU BEGIN

Read these instructions completely and carefully.

- **IMPORTANT** — Save these instructions for local inspector's use.
- **IMPORTANT** — Observe all governing codes and ordinances.
- **Note to Installer** – Be sure to leave these instructions with the Consumer.
- **Note to Consumer** – Keep these instructions for future reference.
- **Skill level** – Installation of this appliance requires basic mechanical skills.
- **Completion time** – 1 to 3 hours
- Proper installation is the responsibility of the installer.
- Product failure due to improper installation is not covered under the Warranty.

⚠ WARNING — This appliance must be properly grounded.

FOR YOUR SAFETY:

⚠ WARNING — Before beginning the installation, switch power off at service panel and lock the service disconnecting means to prevent power from being switched on accidentally. When the service disconnecting means cannot be locked, securely fasten a prominent warning device, such as a tag, to the service panel.

FOR YOUR SAFETY:

All rough-in and spacing dimensions must be met for safe use of your range. Electricity to the range can be disconnected at the outlet without moving the range if the outlet is in the preferred location (remove lower drawer).

To reduce the risk of burns or fire when reaching over hot surface elements, cabinet storage space above the cooktop should be avoided. If cabinet storage space is to be provided above the cooktop, the risk can be reduced by installing a range hood that sticks out at least 5" beyond the front of the cabinets. Cabinets installed above a cooktop must be no deeper than 13"

Be sure your appliance is properly installed and grounded by a qualified technician.

Make sure the cabinets and wall coverings around the range can withstand the temperatures (up to 200°F) generated by the range.

ANTI-TIP DEVICE

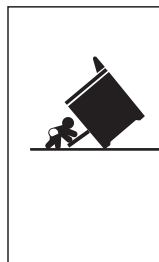

⚠ WARNING

Tip-Over Hazard

- A child or adult can tip the range and be killed.
- Install the anti-tip bracket to the wall or floor.
- Engage the range to the anti-tip bracket by sliding the range back so the anti-tip arm slides under the anti-tip bracket.
- Re-engage the anti-tip bracket if the range is moved.
- Failure to do so can result in death or serious burns to children or adults.

If you did not receive an anti-tip bracket with your purchase, call 1-800-932-4267 to receive one at no cost.

Installation Instructions

PREPARE TO INSTALL THE RANGE

MATERIALS YOU MAY NEED



(UL Approved 40 AMP)

4-Wire Cord OR 3-Wire Cord
4' Long 4' Long

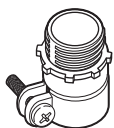

Squeeze Connector (For
Conduit Installations
Only)

TOOLS YOU WILL NEED

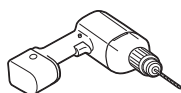

Drill with 1/8" Bit



Safety Glasses



Adjustable Wrench

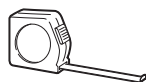

Tape Measure



Pliers



Pencil



1/4" Nut Driver



Level



Phillips Screwdriver



Flat-blade Screwdriver

PARTS INCLUDED

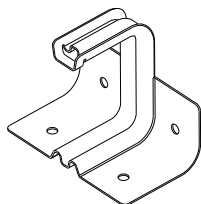

Anti-Tip Bracket Kit

1 REMOVE SHIPPING MATERIALS

Remove packaging materials. Failure to remove packaging materials could result in damage to the appliance.

2 PREPARE THE OPENING

- Allow 2" spacing from the range to adjacent vertical walls above the cooktop surface. Allow 30" minimum clearance between the surface units and the bottom of unprotected wood or metal top cabinet, and 15" minimum between the countertop and adjacent cabinet bottom.
- To eliminate the risk of burns or fire when reaching over hot surface elements, cabinet storage space above the cooktop should be avoided. If cabinet storage space is to be provided above the cooktop, the risk can be reduced by installing a range hood that protrudes at least 5" beyond the front of the cabinets. Cabinets installed above a cooktop may be no deeper than 13".

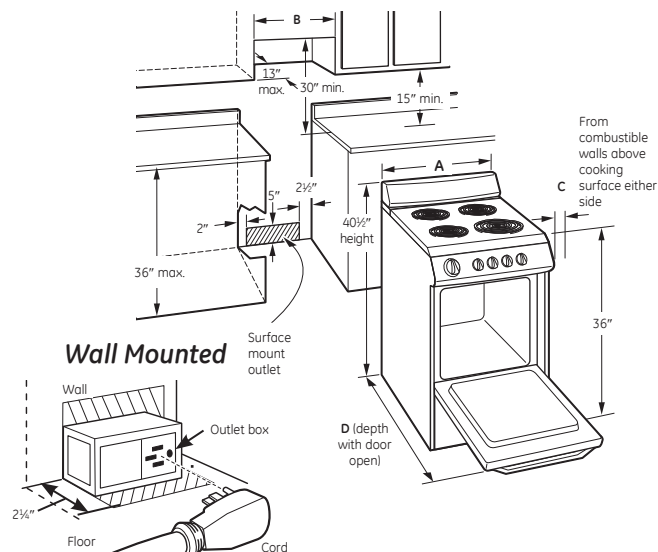

Recommended acceptable electrical outlet area. Orient the electrical receptacle so the length is parallel to the floor.

Models	A	B	C	D
20" Wide	20"	20 3/8"	2"	41"
24" Wide	24"	24 3/8"	2"	41"

Flooring under the range

Your range, like many other household items, is heavy and can settle into soft floor coverings such as cushioned vinyl or carpeting.

When moving the range on this type of flooring, it should be installed on a 1/4" thick sheet of plywood (or similar material) as follows:

When the floor covering ends at the front of the range, the area that the range will rest on should be built up with plywood to the same level or higher than the floor covering. This will allow the range to be moved for cleaning or servicing.

Installation Instructions

ELECTRICAL CONNECTIONS

ELECTRICAL REQUIREMENTS

⚠ CAUTION: For personal safety, do not use an extension cord with this appliance. Remove house fuse or open circuit breaker before beginning installation.

This appliance must be supplied with the proper voltage and frequency, and connected to an individual properly grounded branch circuit, protected by a circuit breaker or fuse having amperage as specified on the rating plate. The rating plate is located under the cooktop. See the Lift-Up Cooktop section in this manual for instructions on how to lift the cooktop.

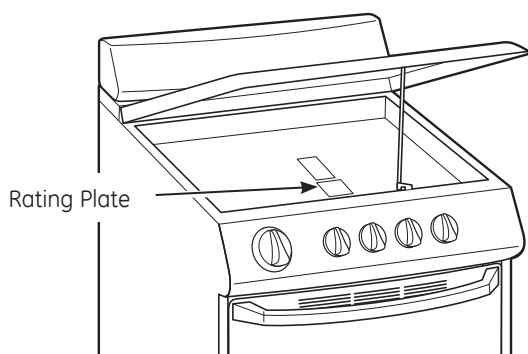

We recommend you have the electrical wiring and hookup of your range connected by a qualified electrician. After installation, have the electrician show you where your main range disconnect is located.

Check with your local utilities for electrical codes which apply in your area. Failure to wire your oven according to governing codes could result in a hazardous condition. If there are no local codes, your range must be wired and fused to meet the requirements of the National Electrical Code, ANSI/NFPA No. 70- Latest Edition. You can get a copy by writing:

National Fire Protection Association
Batterymarch Park
Quincy, MA 02269

Effective January 1, 1996, the National Electrical Code requires that new construction (not existing) utilize a 4-conductor connection to an electric range.

ELECTRICAL REQUIREMENTS (cont.)

When installing an electric range in new construction, follow Steps 3 and 5 for 4-wire connection.

You must use a 3-wire, single-phase A.C. 208Y/120 Volt or 240/120 Volt, 60 hertz electrical system. If you connect to aluminum wiring, properly installed connectors approved for use with aluminum wiring must be used.

If the electrical service provided does not meet the above specifications, have a licensed electrician install an approved outlet.



ALL NEW BRANCH CIRCUIT INSTALLATIONS, MOBILE HOMES, RECREATIONAL VEHICLES AND INSTALLATIONS WHERE LOCAL CODES DO NOT ALLOW GROUNDING THROUGH NEUTRAL, REQUIRE A 4-CONDUCTOR CORD OR CONDUIT

Use only a 3-conductor or a 4-conductor UL-listed range cord. These cords may be provided with ring terminals on wire and a strain relief device.

A range cord rated at 40 amps with 125/250 minimum volt range is required. A 50 amp range cord is not recommended but if used, it should be marked for use with nominal 1 $\frac{3}{8}$ " diameter connection openings. Care should be taken to center the cable and strain relief within the knockout hole to keep the edge from damaging the cable.

- Because range terminals are not accessible after range is in position, flexible service conduit or cord must be used.

NOTE: If conduit is being used, go to Step 3D and then to Step 6 or 7.

- On some models, a filter capacitor may be connected between the black and white leads on the junction block.

Installation Instructions

ELECTRICAL CONNECTIONS (CONT.)

3 POWER CORD AND STRAIN RELIEF INSTALLATION

- A** Remove the wire cover (on the lower back of the range) by removing its top center screw.

Do not discard this screw.

- B** Remove the knockout ring ($1\frac{3}{8}$ " \leq) located on bracket directly below the terminal block. To remove the knockout, use a pair of pliers to bend the knockout ring away from the bracket and twist until ring is removed.

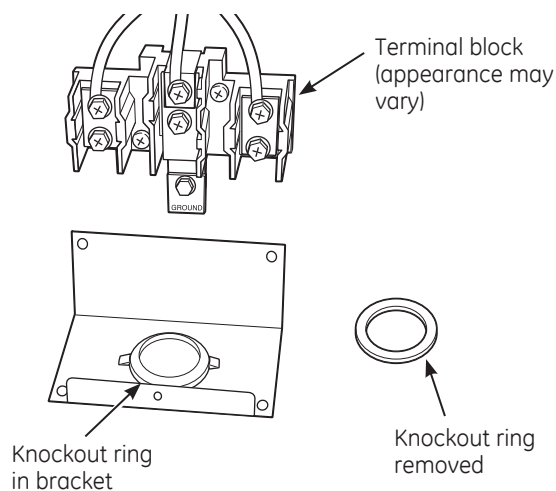

- C** For power cord installations only (see the next step if using conduit), assemble the strain relief in the hole. Insert the power cord through the strain relief and tighten. Allow enough slack to easily attach the cord terminals to the terminal block. If tabs are present at the end of the winged strain relief, they can be removed for better fit.

NOTE: Do not install the power cord without a strain relief. The strain relief bracket should be installed before reinstalling the rear range wiring cover.

Skip to Step 4 or 5.

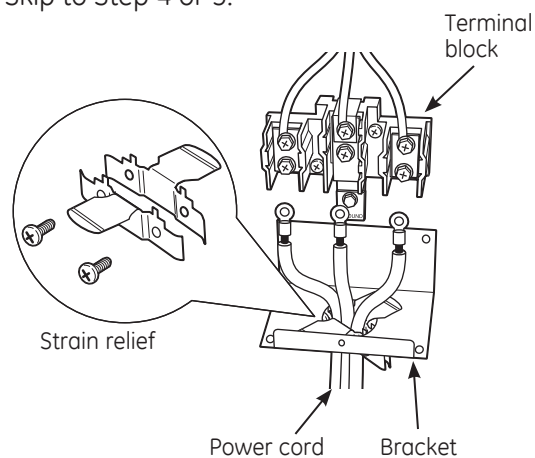

- D** For conduit installations only, purchase a squeeze connector matching the diameter of your conduit and assemble it in the hole. Insert the conduit through the squeeze connector and tighten. Allow enough slack to easily attach the wires to the terminal block.

NOTE: Do not install the conduit without a squeeze connector. The squeeze connector should be installed before reinstalling the rear range wiring cover.

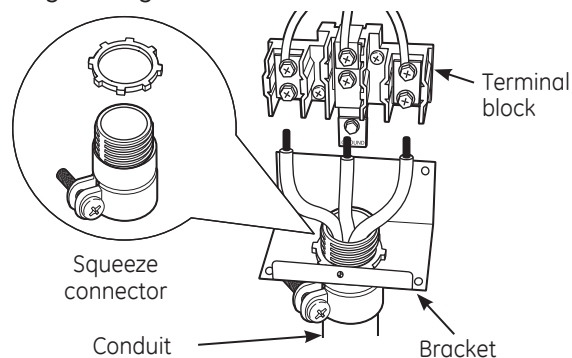

Skip to Step 6 or 7.

Installation Instructions

4 3-WIRE POWER CORD INSTALLATION

⚠ WARNING: The neutral or ground wire of the power cord must be connected to the neutral terminal located in the center of the terminal block. The power leads must be connected to the lower left and the lower right terminals of the terminal block.

- A** Remove the 3 lower terminal screws from the terminal block. Insert the 3 terminal screws through each power cord terminal ring and into the lower terminals of the terminal block. Be certain that the center wire (white/neutral) is connected to the center lower position of the terminal block. Tighten screws securely into the terminal block.

DO NOT remove the ground strap connection.

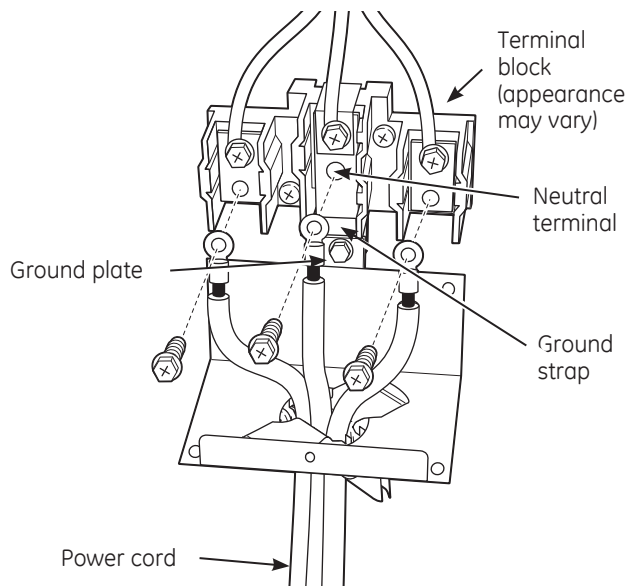

- B** Skip to Step 8 and proceed with the installation.

5 4-WIRE POWER CORD INSTALLATION

⚠ WARNING: The neutral wire of the supply circuit must be connected to the neutral terminal located in the lower center of the terminal block. The power leads must be connected to the lower left and the lower right terminals of the terminal block. The 4th grounding lead must be connected to the frame of the range with the ground plate and the ground screw.

- A** Remove the 3 lower terminal screws from the terminal block. Remove the ground screw and ground plate and retain them.
- B** Cut and discard the ground strap. **DO NOT DISCARD ANY SCREWS.**
- C** Insert the one ground screw into the power cord ground wire terminal ring, through the ground plate and into the frame of the range.
- D** Insert the 3 terminal screws (removed earlier) through each power cord terminal ring and into the lower terminals of the terminal block. Be certain that the center wire (white/neutral) is connected to the center lower position of the terminal block. Tighten screws securely into the terminal block.

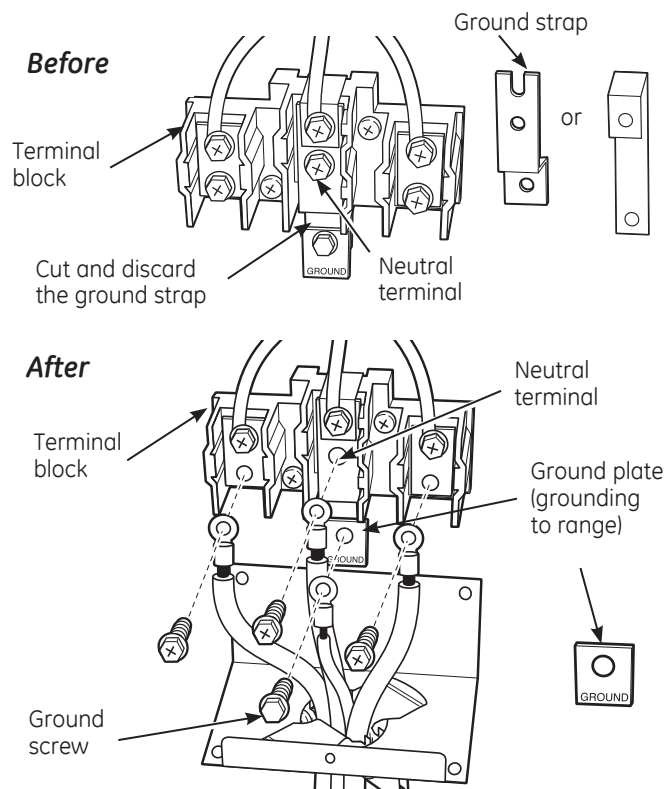

- E** Skip to Step 8 and proceed with the installation.

Installation Instructions

ELECTRICAL CONNECTIONS (CONT.)

6 3-WIRE CONDUIT INSTALLATION

- A** Loosen the 3 lower terminal screws from the terminal block. Insert the center bare wire (white/neutral) tip through the bottom center terminal block opening. On certain models, the wire will need to be inserted through the ground strap opening and then into the bottom center block opening. Insert the two side bare wire tips into the lower left and the lower right terminal block openings. Tighten the screws until the wire is firmly secure (approximately 20 inch-lbs.).

NOTE: ALUMINUM WIRING:

Aluminum building wire may be used but it must be rated for the correct amperage and voltage to make connection. Connect wires according to this Step 6 or Step 7 depending on number of wires.

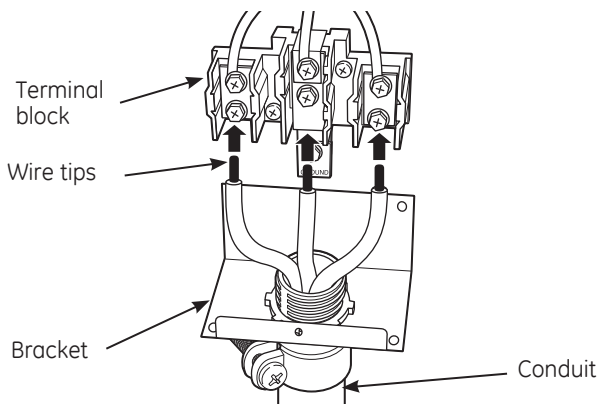

Wire used, location and enclosure of splices, etc., must conform to good wiring practices and local codes.

- B** Skip to Step 8 and proceed with the installation.

7 4-WIRE CONDUIT INSTALLATION

- A** Loosen the three lower terminal screws from the terminal block. Remove the ground screw and ground plate and retain them. **Cut and discard the ground strap. DO NOT DISCARD ANY SCREWS.**
- B** Insert the ground bare wire tip between the range frame and the ground plate (removed earlier) and secure it in place with the ground screw (removed earlier). Insert the bare wire (white/neutral) tip through the bottom center of the terminal block opening. Insert the two side bare wire tips into the lower left and the lower right terminal block openings. Tighten the screws until the wire is firmly secure (approximately 20 inch-lbs.).

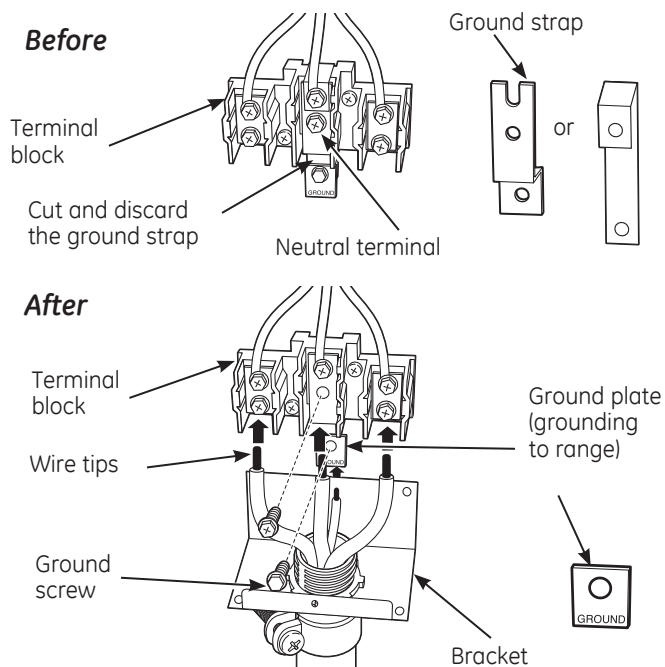

Wire used, location and enclosure of splices, etc., must conform to good wiring practices and local codes.

- C** Proceed to Step 8.

8 REPLACE THE WIRE COVER

Replace the wire cover on the range back by sliding its two lower retaining tabs into the slots and replacing the screw removed earlier. Make sure that no wires are pinched between the cover and the range back.

Installation Instructions

INSTALL THE RANGE

9 ANTI-TIP DEVICE INSTALLATION

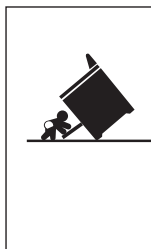

⚠ WARNING

Tip-Over Hazard

- A child or adult can tip the range and be killed.
- Install the anti-tip bracket to the wall or floor.
- Engage the range to the anti-tip bracket by sliding the range back so the anti-tip arm slides under the anti-tip bracket.
- Re-engage the anti-tip bracket if the range is moved.
- Failure to do so can result in death or serious burns to children or adults.

To reduce the risk of tipping the range, the range must be secured by a properly installed anti-tip bracket. See installation instructions shipped with the bracket for complete details before attempting to install.

To check if the bracket is installed and engaged properly, look underneath the range to see that the anti-tip arm attached to the side panel is engaged in the bracket. On some models, the storage drawer or kick panel can be removed for easier inspection. If visual inspection is not possible, slide the range forward, confirm the anti-tip bracket is securely attached to the floor or wall, and slide the range back so the anti-tip arm slides just under the anti-tip bracket. If the range is pulled from the wall for any reason, always repeat this procedure to verify the range is properly secured by the anti-tip bracket.

10 LEVEL THE RANGE

For proper cooking and baking, the range must be leveled. Leveling legs are located on each corner at the base of the range.

- A** Install the oven shelves (see **Using the oven** section for instructions). Put a spirit level or a glass measuring cup partially filled with water on one of the oven shelves.

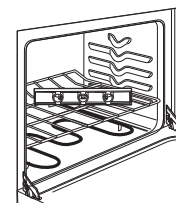

- B** Turn the legs clockwise to raise the range and counterclockwise to lower the range. Adjust the leveling legs until the range is level.

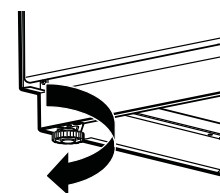

11 FINAL INSTALLATION CHECKLIST

- Check to make sure the circuit breaker is closed (RESET) or the circuit fuses are replaced.
- Be sure power is in service to the building.
- Check to be sure that all packing materials and tape have been removed. This will include tape on metal panel under control knobs (if applicable), adhesive tape, wire ties, cardboard and protective plastic. Failure to remove these materials could result in damage to the appliance once the appliance has been turned on and surfaces have heated.
- Check to make sure that the Anti-Tip device is securely installed.
- Be sure all range controls are in the OFF position before leaving the range.

Before You Call For Service...



Troubleshooting Tips

Save time and money! Review the chart on this page first and you may not need to call for service.

Problem	Possible Causes	What To Do
Surface units not functioning properly	The surface units are not plugged in solidly.	<ul style="list-style-type: none"> • With the controls off, check to make sure the surface unit is plugged completely into the receptacle.
	The surface unit controls improperly set.	<ul style="list-style-type: none"> • Check to see the correct control is set for the surface unit you are using.
	The drip pans are not set securely in the cooktop.	<ul style="list-style-type: none"> • With the controls off, check to make sure the drip pan is in the recess in the cooktop and that the opening in the pan lines up with the receptacle.
Oven will not work	A fuse in your home may be blown or the circuit breaker tripped.	<ul style="list-style-type: none"> • Replace the fuse or reset the circuit breaker.
	Plug on range is not completely inserted in the electrical outlet.	<ul style="list-style-type: none"> • Make sure electrical plug is plugged into a live, properly grounded outlet.
	Oven control improperly set.	<ul style="list-style-type: none"> • See the <i>Using the oven</i> sections.
Food does not broil properly	Oven control improperly set.	<ul style="list-style-type: none"> • Make sure you turn the knob all the way to the BROIL position.
	Improper shelf position being used.	<ul style="list-style-type: none"> • See the <i>Broiling Guide</i>.
	Cookware not suited for broiling.	<ul style="list-style-type: none"> • Use the broiling pan and grid that came with your range.
	Aluminum foil used on the the broiling pan and grid has not been fitted properly and slit as recommended.	<ul style="list-style-type: none"> • See the <i>Use of aluminum foil</i> section.
Food does not bake or roast properly	Oven control improperly set.	<ul style="list-style-type: none"> • See the <i>Using the oven for baking or roasting</i> section.
	Shelf position is incorrect or the shelf is not level.	<ul style="list-style-type: none"> • See the <i>Using the oven for baking or roasting</i> section.
	Necessary preheating was not done.	<ul style="list-style-type: none"> • See the <i>Using the oven for baking or roasting</i> section.
	Incorrect cookware or cookware of improper size being used.	<ul style="list-style-type: none"> • See the <i>Using the oven for baking or roasting</i> section.
Oven light does not work	Light bulb is loose or Switch operating light is broken	<ul style="list-style-type: none"> • <i>Tighten or replace the bulb.</i> • <i>Call for service</i>



FELIX STORCH, INC

770 Garrison Avenue
Bronx, NY

TEL 718-893-3900

FAX 718-842-3093

 info@summitappliance.com

www.summitappliance.com

PARTS AND LABOR WARRANTY INFORMATION

SUMMIT Appliances are manufactured to provide outstanding value, and your satisfaction is our goal on every product. All SUMMIT major appliances carry a one year limited warranty on both parts and labor. All refrigerators and freezers carry an additional four years on the compressor. Certain exclusions may apply.

GENERAL PARTS AND LABOR WARRANTY

Summit warrants, to the original purchaser of every new unit, that the cabinet and all parts thereof be free from defects in material or workmanship, under normal and proper use and maintenance service as specified by Summit and upon proper installation and start-up in accordance with the instruction packet supplied with each Summit unit. Summit's obligation under this warranty is limited to a period of 12 months from the date of original purchase.

Any parts, covered under this warranty, that are determined by Summit to have been defective, within the above said period, are limited to the repair or replacement, including labor charges, of defective parts or assemblies. The labor warranty shall include pre-approved standard straight time labor charges only and reasonable travel time, as determined by Summit.

WARRANTY CLAIMS

All claims for labor or parts must be made directly through Summit. All claims should include: model number of the unit, the serial number of the cabinet, proof of purchase, date of installation, and all pertinent information supporting the existence of the alleged defect. All claims should be filed within 30 days of completed repair or the warranty claim could be refused.

THINGS NOT COVERED BY THIS WARRANTY

Summit's sole obligation under this warranty is limited to either repair or replacement of parts, subject to the additional limitations below. This warranty neither assumes nor authorizes any person to assume obligations other than those expressly covered by this warranty.

- **NO CONSEQUENTIAL DAMAGES:** Summit is not responsible for economic loss; profit loss; or special, direct, indirect, or consequential damages, including without limitation, losses or damages arising from food or product spoilage claims whether or not on account of refrigeration failure.
- **WARRANTY IS NOT TRANSFERRABLE:** This warranty is not assignable and applies only in favor of the original purchaser/user to whom delivered. Any such assignment or transfer shall void the warranties herein made and shall void all warranties, express or implied, including any warranty of merchantability or fitness for a particular purpose.
- **IMPROPER USE:** Summit assumes no liability for parts or labor coverage for component failure or other damages resulting from improper usage or installation or failure to clean and/or maintain product as set forth in the warranty packet provided with the unit.
- **ALTERATION, NEGLIGENCE, ABUSE, MISUSE, ACCIDENT, DAMAGE DURING TRANSIT OR INSTALLATION, FIRE, FLOOD, ACTS OF GOD:** Summit is not responsible for the repair or replacement of any parts that Summit determines have been subjected after the date of manufacture to alteration, neglect, abuse, misuse, accident, damage during transit or installation, fire, flood, or act of God.
- **IMPROPER ELECTRICAL CONNECTIONS:** Summit is not responsible for the repair or replacement of failed or damaged components resulting from electrical power failure, the use of extension cords, low voltage, or voltage drops to the unit.



FELIX STORCH, INC

770 Garrison Avenue
Bronx, NY

TEL 718-893-3900

FAX 718-842-3093

 info@summitappliance.com

www.summitappliance.com

- **NO IMPLIED WARRANTY OF MERCHANTABILITY OR FITNESS FOR A PARTICULAR PURPOSE:** There are no other warranties, expressed, implied or statutory, except the parts & labor warranty specifically described above. These warranties are exclusive and in lieu of all other warranties, including implied warranty and merchantability or fitness for a particular purpose. There are no other warranties which extend beyond the description on the face hereof.
- **OUTSIDE UNITED STATES:** This warranty does not apply to, and Summit is not responsible for, any warranty claims made on products sold or used outside the United States.

REQUESTING SERVICE

If you are in need of service, please either fill out a service request on our website, <http://www.summitappliance.com/support>, or call us at 800-932-4267 or 718-893-3900. Please be prepared to give us the following information: your name, address, phone, email, model, serial, date of purchase, place of purchase, and the problem you are having.

CALIFORNIA PROPOSITION 65

WARNING! This product may contain chemicals known to the state of California to cause cancer or birth defects or other reproductive harm. For more information, visit: www.summitappliance.com/prop65

Chemicals known by the manufacturer to be present in this product in concentrations higher than threshold limits: NONE.