

Installation and Operation Manual



F R I E D R I C H



Models

Indoor Unit	MWM09Y1J	MWM12Y1J
Outdoor Unit	MRM09Y1J	MRM12Y1J

◆ CONTENTS

Operation and maintenance

■ Notices for use	1
■ Names and functions of each part	3
■ Operation of remote controller	4
■ Emergency operation	10
■ Routine Maintenance	11
■ Basic Troubleshooting	12
■ Service & Assistance	14

Installation service

■ Service & Assistance	15
■ Notices for installation	16
■ Installation dimension diagram	17
■ Install indoor unit	19
■ Install outdoor unit	20
■ Check after installation and test operation	21



This symbol stands for the items should be forbidden.



This symbol stands for the items should be followed

Thank you for choosing Friedrich Air Conditioning, please read this owner's manual carefully before operating the unit and keep it carefully for consultation.

This appliance is not intended for use by persons (including children) with reduced physical, sensory or mental capabilities or lack of experience and knowledge, unless they have been given supervision or instruction concerning use of the appliance by a person responsible for their safety.

Children should be supervised to ensure that they do not play with the appliance.





Do not dispose of this product as unsorted municipal waste. Collection of such waste separately for special treatment is necessary.

Congratulations

Thank you for your decision to purchase Friedrich. Your new Friedrich has been carefully engineered and manufactured to give you many years of dependable, efficient operation, maintaining a comfortable temperature and humidity level. Many extra features have been built into your unit to assure quiet operation, the greatest circulation of cool, dry air, and the most economic operation.

General Instructions

This Installation and Operation Manual has been designed to insure maximum satisfaction in the performance of your unit. For years of trouble-free service, please follow the installation instructions closely. We cannot overemphasize the importance of proper installation.



 WARNING	
	<p>Refrigeration system under high pressure</p> <p>Do not puncture, heat, expose to flame or incinerate.</p> <p>Only certified refrigeration technicians should service this equipment.</p> <p>R410A systems operate at higher pressures than R22 equipment. Appropriate safe service and handling practices must be used.</p> <p>Only use gauge sets designed for use with R410A. Do not use standard R22 gauge sets.</p>

Here are some suggestions to help you use your new Friedrich most efficiently:

1. Carefully read and follow the installation instructions.
2. Make sure the unit is the right capacity for the area being cooled. An undersized unit makes the unit work too hard, using more electricity than needed and increases wear. An oversized unit will cycle on and off too rapidly, and therefore cannot control humidity as well.
3. Clean the filter frequently (See Routine Maintenance, Page 23).
4. Do not block the air flow to and from the unit.
5. A dirty filter or improperly set controls can affect the cooling ability of the unit.
6. If cooling is weak and you have verified that the filter is clean

and the controls are properly set, the unit may need service and you should call your Friedrich service provider to check the unit.

7. Keep blinds, shades and drapes closed on the sunny side of the room being cooled to reduce radiant heat.
8. Proper insulation helps your unit maintain the desired inside temperature.
9. Whenever possible, shade south and west facing windows.
10. Keep window coverings away from the unit to provide free air flow.

 WARNING	
	<p>Read Installation Operation Manual</p> <p>Please read this manual thoroughly prior to equipment installation or operation.</p> <p>It is the installer's responsibility to properly apply and install the equipment. Installation must be in conformance with the NFPA 70 -2008 National Electric Code or current edition, International Mechanic Code 2009 or current edition and any other applicable local or national codes.</p> <p>Failure to do so can result in property damage, personal injury or death.</p>

Your safety and the safety of others are very important.

We have provided many important safety messages in this manual and on your appliance. Always read and obey all safety messages.



This is a safety Alert symbol.
This symbol alerts you to potential hazards that can kill or hurt you and others.
All safety messages will follow the safety alert symbol with the word "WARNING" or "CAUTION". These words mean:



Indicates a hazard which, if not avoided, can result in severe personal injury or death and damage to product or other property.



Indicates a hazard which, if not avoided, can result in personal injury and damage to product or other property.

All safety messages will tell you what the potential hazard is, tell you how to reduce the chance of injury, and tell you what will happen if the instructions are not followed.



Indicates property damage can occur if instructions are not followed.

◆ Notices for use

Working principle and special functions for cooling

Principle:

Air conditioner absorbs heat in the room and transmit to outdoor and discharged, so that indoor ambient temperature decreased, its cooling capacity will increase or decrease by outdoor ambient temperature.

Anti-freezing function:

If the unit is running in COOL mode and in low temperature, there will be frost formed on the heat exchanger, when indoor heat exchanger temperature decreased below 0°C, the indoor unit microcomputer will stop compressor running and protect the unit.

Working principle and special functions for heating

Principle:

- * Air conditioner absorbs heat from outdoor and transmits to indoor, in this way to increase room temperature. This is the heat pump heating principle, its heating capacity will be reduced due to outdoor temperature decrease.
- * If outdoor temperature becomes very low, please operate with other heating equipments.

Defrosting:

- * When outdoor temperature is low but high humidity, after a long while running, frost will form on outdoor unit, that will effect the heating effect, at this time, the auto defrosting function will act, the heat running will stop for 8-10mins.
- * During the auto defrosting, the fan motors of indoor unit and outdoor unit will stop.
- * During the defrosting, the indoor indicator flashes, the outdoor unit may emit vapor. This is due to the defrosting, it isn't malfunction.
- * After defrosting finished, the heating will recover automatically.

Anti-cool wind function:

In "Heat" mode, under the following three kinds of state, if indoor heat exchanger doesn't arrive at certain temp., indoor fan will not act, in order to prevent cool wind blowing (within 2 mins):

1. Heating starts.
2. After Auto Defrost finished.
3. Heating under the low temperature.

Gentle Breeze

In the following situation, the indoor unit may blow gentle breeze, and the guide louver rotate to a certain position:

1. In "Heat" mode, the unit turned on, the compressor doesn't arrive the starting condition.
2. In "Heat" mode, the temperature arrive at the setting value and the compressor stop running about 1min.

◆ Notices for use

※ Working temperature range		
	Indoor side DB/WB(°F)	Outdoor side DB/WB(°F)
Maximum cooling	90/73	109/79
Maximum heating	81/---	75/64

The operating temperature range (outdoor) heat pump unit is 5°F~ 109°F. 115V Model

◆ Names and functions of each part

Indoor unit

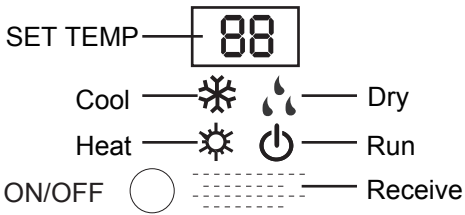
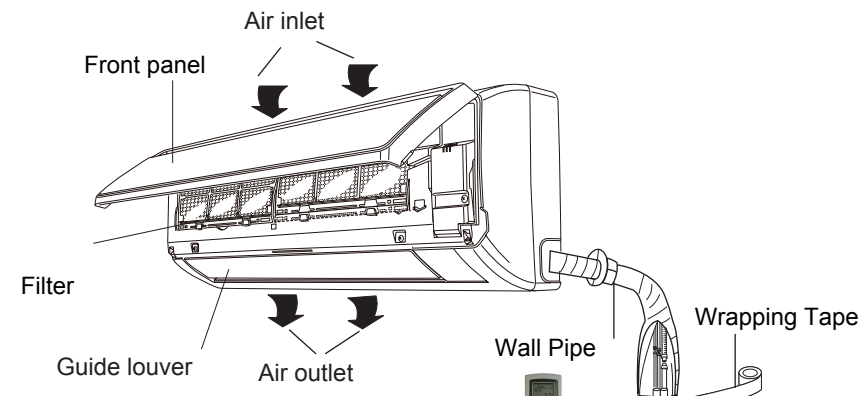

Outdoor unit

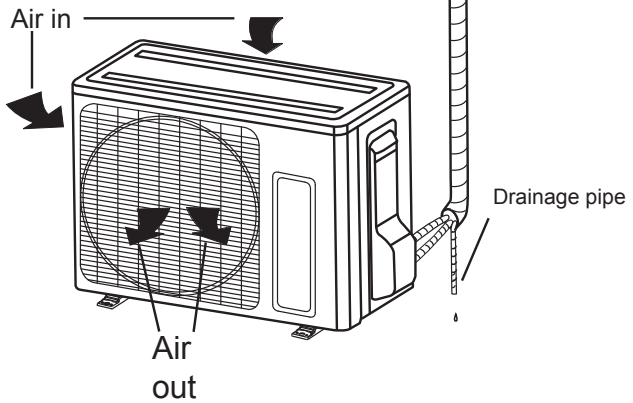

◆ Operation of Remote Controller



- 1 **START / STOP**
Press to start or stop operation.
- 2 ▼ : Press to decrease temperature setting.
- 3 ▲ : Press to increase temperature setting.
- 4 **FAN AUTO**
Press to set fan speed.
- 5 **MODE**
Press to select operation mode (AUTO/COOL/DRY/FAN/HEAT).
- 6 **SENSOR**
- 7 **CLOCK**
Press it set clock.
- 8 **TIMER ON**
Press it to set auto-on timer.
- 9 **AIR SWEEP**
Press it set swing angle.
- 10 **EXTEND**
- 11 **TEMP**
- 12 **TIMER OFF**
Press it to set auto-off timer
- 13 **TURBO**
- 14 **SLEEP**
- 15 **LIGHT**
Press it to turn on/off the light.

◆ Operation of Remote Controller

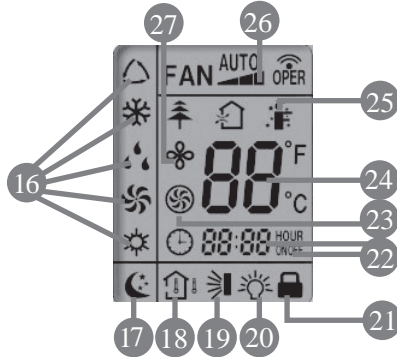

16 MODE icon:

If MODE button is pressed, current operation mode icon \triangle (AUTO), \ast (COOL), ☾ (DRY), ☼ (FAN) or ☀ (HEAT only for heat pump models) will show.

17 SLEEP icon :

☾ is displayed by pressing the SLEEP button. Press this button again to clear the display.

18 TEMP icon:

Pressing TEMP button, $\hat{\text{h}}$ (set temperature), $\hat{\text{i}}$ (indoor ambient temperature) $\hat{\text{o}}$ (outdoor ambient temperature) and blank is displayed circularly.

19 AIR SWEEP icon:

☼ is displayed when pressing the AIR SWEEP button. Press this button again to clear the display.

20 LIGHT icon:

💡 is displayed by pressing the LIGHT button. Press LIGHT button again to clear the display.

21 LOCK icon:

🔒 is displayed by pressing "+" and "-" buttons simultaneously. Press them again to clear the display.

22 SET TIME display:

After pressing TIMER button, ON or OFF will blink. This area will show the set time.

23 TURBO icon:

☼ is displayed when pressing the TURBO button. Press this button again to clear the display.

24 DIGITAL display:

This area will show the set temperature.

◆ Operation of Remote Controller

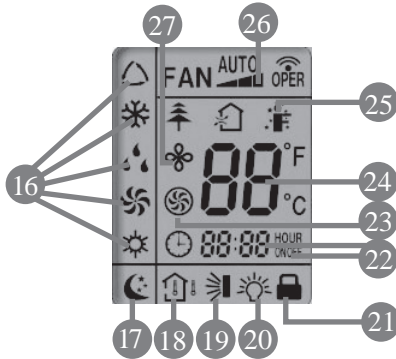

25 SENSOR icon:

 is displayed when pressing the SENSOR button. Press this button again to clear the display.

27 EXTEND icon:

 is displayed when pressing the EXTEND button. Press this button again to clear the display.

26 FAN SPEED display:

Press FAN button to select the desired fan speed setting (AUTO-Low-Med-High). Your selection will be displayed in the LCD windows, except the AUTO fan speed.

◆ Remote Control Instructions

Remote Controller Description

1 START / STOP:

Press this button to turn on the unit .Press this button again to turn off the unit.



2 ▼ :

Press this button to decrease set temperature. Hold it down for 2 seconds or more to rapidly decrease set temperature. In AUTO mode, set temperature is not adjustable.

3 ▲ :

Press this button to increase set temperature. Hold it down for 2 seconds or more to rapidly increase set temperature. In AUTO mode, set temperature is not adjustable.

4 FAN AUTO :

This button is used for setting Fan Speed in the sequence that goes from AUTO, , , to , then back to Auto.



5 MODE :

Each time you press this button, a mode is selected in a sequence that goes from AUTO, COOL, DRY, FAN, and HEAT *, as the following:





*Note: Only for models with heating function.

After energization, AUTO mode is defaulted. In AUTO mode, the set temperature will not be displayed on the LCD, and the unit will automatically select the suitable operation mode in accordance with the room temperature to make indoor room comfortable.

6 SENSOR (SAVE) :

Press this button to turn on SENSOR(SAVE) function. Saves room ambient temperature and automatically adjusts maintaining that room ambient until pressed again which cancels the SENSOR(SAVE) function.

7 CLOCK :

Pressing CLOCK button,  blinks. Within 5 seconds, pressing + or - button adjusts the present time. Holding down either button above 2 seconds increases or decreases the time by 1 minute every 0.5 second and then by 10 minutes every 0.5 second. During blinking after setting, press CLOCK button again to confirm the setting, and then  will be constantly displayed.

◆ Remote Control Instructions

8 TIMER ON :





Press this button to initiate the auto-ON timer. To cancel the auto-timer program, simply press this button again.

After pressing this button,  disappears and "ON "blinks. 00:00 is displayed for ON time setting. Within 5 seconds, press + or - button to adjust the time value. Every press of either button changes the time setting by 1 minute. Holding down either button rapidly changes the time setting by 1 minute and then 10 minutes. Within 5 seconds after setting, press TIMER ON button to confirm.

9 AIR SWEEP:

Press this button to set up & down swing angle, which circularly changes as below:



This remote controller is universal. If any command ,  or  is sent out, the unit will carry out the command as 

 indicates the guide louver swings as:



10 EXTEND(DRY):

Pressing EXTEND button in COOL or DRY mode, the icon  is displayed and the indoor fan will continue operation for 10 minutes in order to dry the indoor unit even though you have turned off the unit.

After energization, EXTEND OFF is defaulted. EXTEND is not available in AUTO, FAN or HEAT mode.

11 TEMP:

By pressing this button you can display the indoor setting temperature or indoor ambient temperature. When the indoor unit is first powered on it will display the setting temperature, if the temperature's display status is changed from other status to "  ", displays the ambient temperature, 5s later or within 5s, it receives other remote control signal that will return to display the setting temperature. If the users haven't set up the temperature displaying status, that will display the setting temperature. (This function is not applicable for some models).

12 TIMER OFF :

Press this button to initiate the auto-off timer. To cancel the auto-timer program, simply press the button again. TIMER OFF setting is the same as TIMER ON.

13 TURBO:



Press this button to activate / deactivate the Turbo function which enables the unit to reach the preset temperature in the shortest time. In COOL mode, the unit will blow strong cooling air at super high fan speed. In HEAT mode, the unit will blow strong heating air at super high fan speed. (This function is not applicable for some models).

Remote Control Instructions



14 SLEEP:

Press this button to go into the SLEEP operation mode. Press it again to cancel this function. This function is available in COOL or DRY mode to maintain the most comfortable temperature for you.

15 LIGHT:

Press LIGHT button to turn on the display's light and press this button again to turn off the display's light. If the light is turned on,  is displayed. If the light is turned off,  disappears.

16 Combination of "+" and "-" buttons: About lock

Press "+" and "-" buttons simultaneously to lock or unlock the keypad. If the remote controller is locked,  is displayed. In this case, pressing any button,  blinks three times.

17 Combination of "MODE" and "-" buttons: Allows you to toggle between Fahrenheit and Celsius.

When the unit is OFF, press "MODE" and "-" buttons simultaneously to switch between °C and °F.

Replacement of Batteries

1. Remove the battery cover plate from the rear of the remote controller. (As shown in the figure)
2. Take out the old batteries.
3. Insert two new AAA1.5V dry batteries, and pay attention to the polarity (+/-).
4. Reinstall the battery cover plate

★ Notes:

- When replacing the batteries, do not use old or different types of batteries, it may cause malfunction.
- If the remote controller will not be used for a long time, please remove batteries to prevent batteries from leaking.
- Remote should be kept **3 feet** away from the TV set or stereos.
- If the remote controller does not operate normally, remove batteries and reinsert after 30 seconds. If abnormal operation continues, replace the batteries.

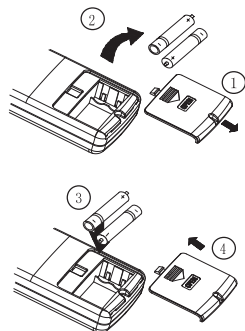



Diagram for removal of batteries

◆ Front Panel Illumination On/Off

Display indicator light control of indoor unit

- Display indicator light on: To turn 'On' the light function, the icon  will display on the remote control screen by pressing the "Light" button. In which case, the display indicator light will be on if the unit receives this signal.
- Display indicator light off: To turn 'Off' the light function, the  will disappear on the remote control screen by pressing this button. In which case, the display indicator light will be off if the unit receives this signal.

Emergency operation

If the wireless remote control is lost or broken, please use the manual switch button. At this time, the unit will run in the Auto mode, the temperature and fan speed cannot be changed. The operation is shown below:

(Fig. 3) Open front panel and the manual switch is on the rightside near electrical connection cover.

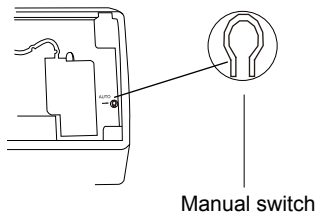

Fig.3

- Turn on the unit:
Press manual button and unit will run in Auto mode immediately. The unit will adjust to the indoor temperature previously selected (Cooling or Fan) and obtain a comfortable setting.
- Turn off the unit: Press manual switch to turn off unit.

Routine Maintenance



Caution

- Turn power off and pull out the power plug before cleaning air conditioner, or it may cause electric shock.
- Never spray water directly into indoor or outdoor components while power is connected as electrocution or shock can occur.
- Volatile liquid (e.g. thinner or gasoline) will damage the air conditioner. (Wipe the unit with a dry soft cloth, or a cloth slightly moistened with water or cleanser.)

Cleaning the front panel

When cleaning the front panel, please dip the cloth into water with temperature below 113°F, then dry the cloth and wipe the front panel or dirty portion of front.

Note: Do not immerse the front panel in water, there are PCB (electronic) components and circuit diagrams on the front panel that may become damaged.

Clean the air filter (Recommended once every three months)

NOTE: If there is an excessive amount of dust around the air conditioner, the air filter should be cleaned more frequently. Once filters are removed do not touch fins, edges may be sharp. Failure to do so can result in minor to moderate personal injury.

① Removing air filter

on both sides of the front panel are slots pull front open, pull the air filter downward and take it out, please see the Fig. 4(a, b).

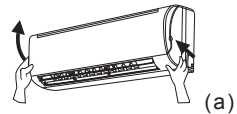

② Clean the air filter

To clean the dust adhering to the filters, you can either use a vacuum cleaner, or wash them with warm water and neutral detergent (the water should be below 113°F degree), and allow to dry.

NOTE: Never use water above 113°F to clean, or it can cause deformation or discoloration.

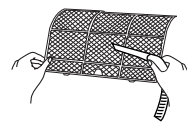

③ Reinsert the air filter

Reinsert the filters along the same location they had been removed from and snap front panel back into place.

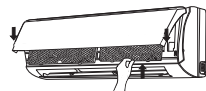

Fig.4

◆ Basic Troubleshooting



CAUTION

Don't attempt to repair the air conditioner by yourself, it can cause an electric shock or fire. Please check the following items before asking for repair, it can save your time and money.

Complaint	Cause	Solution
Unit does not operate.	<ul style="list-style-type: none"> ● Unit turned off ● Thermostat is satisfied ● Local power failure 	<ul style="list-style-type: none"> ● Turn unit on. ● Raise/Lower temperature setting. ● Unit will resume normal operation once power has been restored.
Unit has an unual odor.	<ul style="list-style-type: none"> ● Ambient Air 	<ul style="list-style-type: none"> ● Clean air filter. ● Clean air conditioner. ● Please contact an Authorized Friedrich Service Agency
The sound of water flow during operation.	<ul style="list-style-type: none"> ● Sound of refrigerant flowing 	<ul style="list-style-type: none"> ● When the compressor starts or stops running you may here a swoosh or gurgle, this isn't a malfunction.
In COOL Mode there is a mist emitted from the vent.	<ul style="list-style-type: none"> ● When the indoor temperature and humidity are high and there is a rapid cool down in the room. 	<ul style="list-style-type: none"> ● After running for a period of time the indoor temperature and humidity will decrease, mist will fade away.
Unit does not cool/heat room sufficiently.	<ul style="list-style-type: none"> ● The return/discharge air grille is blocked. ● Windows or doors to the outside are open. ● The setpoint is not set to a cool/warm enough setting. ● Ambient temperature of the space is to hot/cool. ● Outdoor coil is dirty or obstructed. ● The indoor filter is dirty or obstructed ● The system was not properly sized for the heat load requirements of the space 	<ul style="list-style-type: none"> ● Check that return/discharge air are not blocked. ● Check that windows and doors are closed. ● Adjust setpoint to a more comfortable setting. ● Please allow more time for system to cool/heat living space ● Please contact servicer to properly clean coils. ● Clean filter - (Refer to routine maintenance section for instruction) ● Please contact your servicer for more information if previous options do not remedy the issue.

◆ Basic Troubleshooting

Complaint	Cause	Solution
Wireless Remote control does not work.	<ul style="list-style-type: none"> ● Not in frequency range 	<ul style="list-style-type: none"> ● Remove batteries and reinstall. ● Replace batteries.
There is water leaking into living space from indoor unit.	<ul style="list-style-type: none"> ● High humidity 	<ul style="list-style-type: none"> ● Humid conditions in living space. ● Condensate drain overflow. ● Drain pipe to indoor unit is loose.
There is water leaking from outdoor unit.	<ul style="list-style-type: none"> ● Unit is running in cool mode ● Unit is running in Auto defrost mode ● Unit is running in Heat mode 	<ul style="list-style-type: none"> ● Condensation may have formed on piping. ● Ice may have formed and is defrosting into unit. ● Condensation may have dripped off outdoor coil.
Noise from indoor unit.	<ul style="list-style-type: none"> ● Sound of fan ● Defrost of indoor coil 	<ul style="list-style-type: none"> ● Sound can be blower or motor please contact a service center if noise persists. ● Coil can become frosted in some conditions and unit will cycle into a defrost sound may be ice thawing inside. Once defrost is complete sound should not occur.
Indoor unit not blowing air	<ul style="list-style-type: none"> ● Unit is in Defrost mode. 	<ul style="list-style-type: none"> ● Unit may have switched off for outdoor coil to defrost in low ambient conditions function will resume.
Moisture on air vent	<ul style="list-style-type: none"> ● High Humidity 	<ul style="list-style-type: none"> ● Condensation may have formed and dripped off grille due to extended cooling.



Immediately stop all operations and plug out, contact the dealer if following situations occur.

There is harsh sound during operation.
 There unusual and offending odors emitted during operation.
 Water is leaking in the room.
 Breaker or Time delay fuse often trips.
 Accidentally splashed water or other liquids into unit.
 There is excessive or abnormal heat emanating from the power cords.



Turn off unit and switch off breaker.

◆ Service & Assistance

Before calling for service, please check the "Basic troubleshooting" section above. This may help you to find the answer to your problem, avoid unnecessary service calls, and save the cost of a service call if the problem is not due to the product itself. If you have checked the "Basic troubleshooting" section and still need help, below you will find a list of available services:

- 1 You can find the name of your local Authorized Service Provider by visiting our website at www.friedrich.com.
- 2 If you require further assistance please call Friedrich customer support at 1-800-541-6645.
- 3 Before calling please make sure that you have the full model and serial number, as well as the date of purchase of you equipment available. Providing us with this information will allow us to better assist you.

Our specialists are able to assist you with:

- * Specifications and Features of our equipment
- * Referrals to dealers, and distributors.
- * Use and Care information
- * Recommended maintenance procedures
- * Installation information
- * Referrals to Authorized Service Providers and Parts depots.

◆ Installation



Important Notices

Indoor Unit Placement

1. Air inlet and discharge should be kept free of obstruction at all times. Ensure airflow through living space.
2. Condensate should drain easily from unit.
3. Keep system out of the reach of children and pets.
4. Installation choice should be strong enough to handle the weight of the equipment and insulate against vibration noise from operation.
5. Be sure to leave enough space to allow access for routine maintenance. The height of the installed location should be 8 ft or more from the floor.
6. Select a place 3 ft or more away from TV or any other electric appliances.
7. Select a place where the filter can be easily taken out.
8. Follow installation requirements and dimensions.
9. Do not use the unit in the immediate surroundings of a laundry, bath, shower or swimming pool

Outdoor Unit Placement

1. Select a location with consideration of surroundings including pets and neighbors as heat and cool will be discharged from equipment.
2. Select a location where there should be sufficient ventilation.
3. Select a location where there should be no obstructions cover the inlet and outlet.
4. The location should be able to withstand the full weight and vibration of the outdoor unit and permit safe installation.
5. Select a dry place, but do not expose under the direct sunlight or strong wind.
6. Make sure that the outdoor unit installation dimension are in accordance with installation dimension diagram, convenient for maintenance, repair.
7. The height difference of connecting the tubing within 16 ft, the length of connecting the tubing within 33 ft.
8. Select a place where it is out of reach for the children.
9. Select a place where will not block the passage and do not influence the city appearance.

◆ Notices for installation

Outdoor Unit Installation Position Selection

1. Consideration should be made in location of outdoor unit as heat/cool is emitted, pets and neighbors could be affected by this.
2. Select a location where there should be sufficient ventilation.
3. Select a location where there should be no obstructions to cover the inlet and outlet.
4. The location should be able to withstand the full weight and vibration of the outdoor unit and permit safe installation.
5. Select a dry place, but do not expose under the direct sunlight or strong wind.
6. Installation should follow instructions and dimensions.

Safety Requirements For Electric Appliances

1. Ensure that power circuit is dedicated and not shared with other equipment.
Power cable diameter should be followed.
2. Do not damage power cord.
3. The breaker switch must have the functions of magnetic tripping and heat tripping, in order to protect from short circuit.
4. Keep system 5 feet from combustibles.
5. Be sure to follow local and national electrical code.

Note:

- Follow wiring diagram to ensure that short circuit will not happen. Incorrect wiring can cause potential for fire.

◆ Installation dimension diagram

Installation dimension diagram

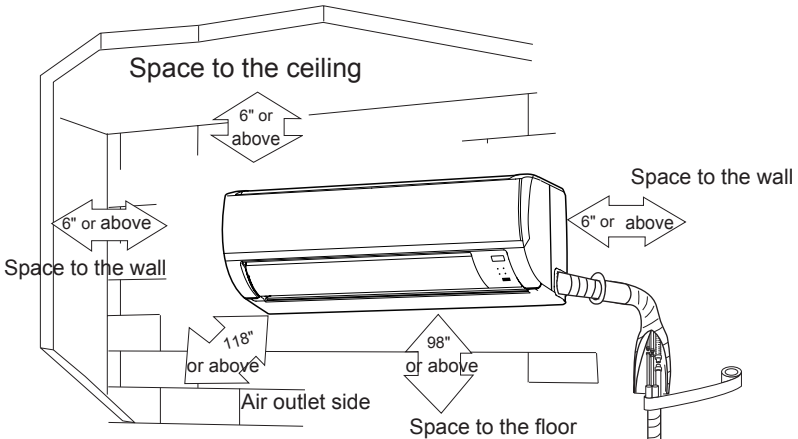

- The dimensions of the space necessary for correct installation of the appliance including the minimum permissible distances to adjacent structures

**Note *Min/Max
Line Length 10'/65'**

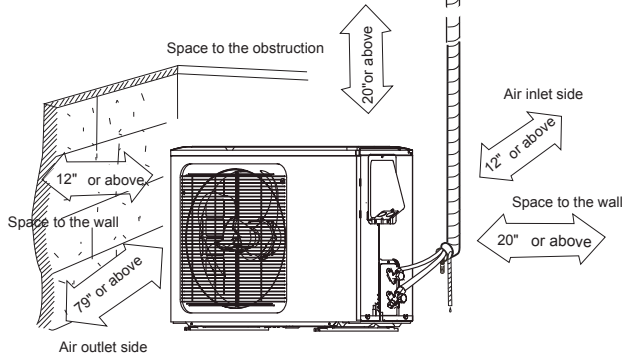

◆ Install indoor unit

Install the rear panel

1. Always mount the rear panel horizontally. Due to the condensate tray inside the indoor unit, the outlet side of the pan should have a slight tilt to assist in the gravity draining of the water in the pan. The angle between the evaporator and level should be 0 or more. This will assist with drainage.
2. Fix the rear panel on the wall with screws.
3. Be sure that the rear panel has been secured firmly enough to withstand the weight of an adult of 130lbs.

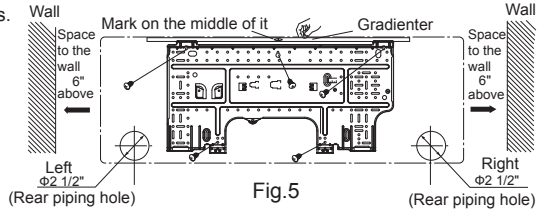

Install the piping hole

1. Make the piping hole ($\Phi 2 \frac{1}{2}$ ") in the wall at a slight downward slant to the outdoor side.
2. Insert the piping-hole sleeve into the hole to prevent the connection piping and wiring from being damaged when passing through the hole.

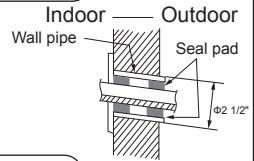

Install the water drainage pipe

1. For well draining, the drain hose should be placed at a downward slant.
2. Do not wrench or bend the drain hose, overflow can occur.
3. If routing the condensate drain with piping, wrap with insulation.

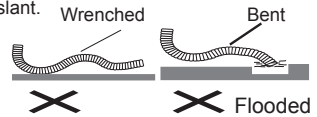

Connect indoor and outdoor electric wires

1. Open the front panel.
2. Remove the wiring cover and wire clamp. Make the power connection cord pass through the hole at the back of indoor unit.
3. Connect and fix the power connection cord to the terminal board.
4. Fix the power connection cord with wire clamp and reinstall wiring cover.
5. Reinstall the front panel.

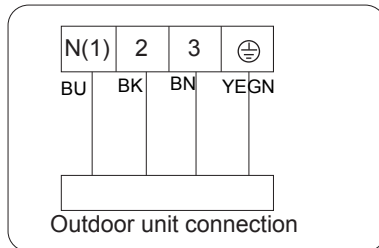

◆ Install indoor unit

NOTE:

Do not splice electrical wire together if too short, purchase new wire of correct length to install. otherwise communication errors can occur.

- The wiring must be correctly connected, improper wiring can cause malfunction.
- Tighten terminal firmly to ensure wiring will not come loose, but do not over tighten as damage to terminal can occur.
- Ensure ground wire is connected properly otherwise electrical hazard can occur.
- The cover plate must be installed if poorly installed dust and moisture may enter or the terminal will be affected by the outside environment, and will cause fire or electric shock.

Install the indoor unit

- The piping can be lead out from right, right rear, left or right side of indoor unit, cut off the tailings from the chassis in necessary(Show in Fig.6)

1. When routing the piping and wiring from the left or right side of indoor unit, cut off the tailings from the chassis in necessary(Show in Fig.6)
 - (1)Cut off the tailings 1 when routing the wiring only;
 - (2)Cut off the tailings 1 and tailings 2 when routing both the wiring and piping.
2. Take out the piping from body case, wrap the piping electric wire, water pipe with tape and pull them through the piping hole (As show in Fig.7)
3. Hang the mounting slots of the indoor unit on the upper tabs of the rear panel and check if it is firm enough.(As show in Fig.8)
4. The height of the installed location should be 8ft or more from floor.

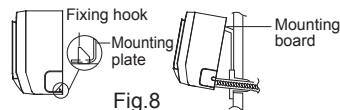
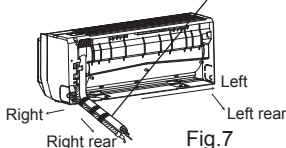
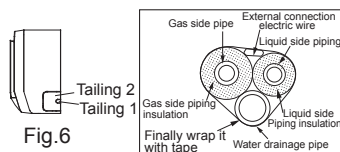

Install the connection pipe

1. Align the center of the piping flare with the relevant valve.
2. Screw in the flare nut by hand and then tighten the nut with spanner and torque wrench refer to the following:

Hex nut diameter	Tightening torque (lb.ft)
Φ6	11~14.7
Φ 9.52	22.8~25.8
Φ 12	36.9~40.6
Φ 16	44.3~47.9
Φ 19	51.6~55.3

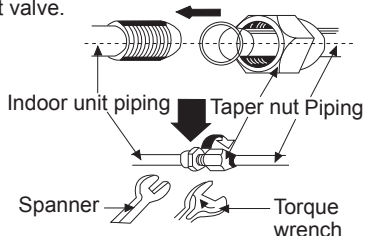

NOTE: Connect indoor piping first, then take care bending pipe to outdoor unit, then install piping there. Do not over tighten the flares as leaks can occur.

◆ Install outdoor unit

Electrical wiring

1. Remove the cover on right side of outdoor unit.
2. Take off wire clamp. Connect and fix the power connection cord to the terminal board. Wiring should be sized for indoor unit too.
3. Fix the power connection cord with wire clamp.
4. Confirm if the wire has been tightened properly.
5. Reinstall terminal cover.

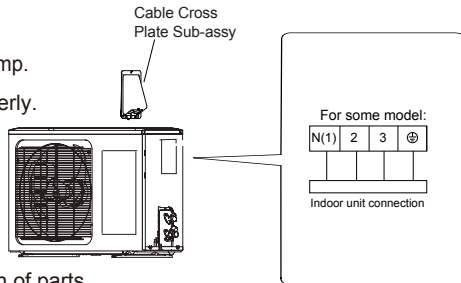

NOTE:

- Incorrect wiring may cause malfunction of parts.
- After the wire has been fixed, ensure that no wires will contact others.

Air purging and leakage test

1. Connect charging hose of manifold valve to charge end of low pressure valve (both high/low pressure valves must be tightly shut).
2. Connect joint of charging hose to vacuum pump.
3. Fully open handle of Lo manifold valve.
4. Open the vacuum pump to evacuate. At the beginning, slightly loosen joint nut of low pressure valve to check if there is air coming inside. (If noise of vacuum pump has been changed, the reading of multimeter is 0) Then tighten the nut.
5. Keep evacuating for more than 15 mins and make sure the reading of multi-meter 500 Microns and holding.
6. Fully open high/low pressure valves.
7. Remove charging hose from charging end of low pressure valve.
8. Tighten bonnet of low-pressure valve. (As shown in Fig.9)

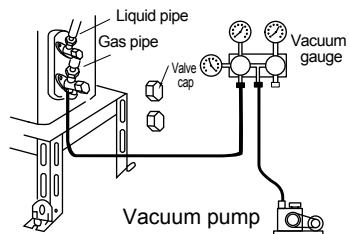
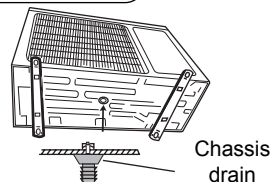

Fig.9

Condensate drainage of outdoor unit (no for cooling only)

The condensate and defrosting water formed during heating in the outdoor unit can be properly discharged by drainage pipe.

Installation method: set the drain connection in $\varnothing 25$ hole of the chassis has been installed and then connect drainage pipe with drain nozzle, so that condensate and defrosting water can be properly discharged.



◆ Check after installation and test operation

Check after installation

Items to be checked	Possible malfunction
Is unit installed correctly?	Unit may fall, shake or create excessive noise.
Have you done the refrigerant leakage test?	Leak of refrigerant can occur and system will not cool.
Is equipment insulated properly?	It may cause condensation and dripping.
Is water drainage good?	It may cause condensation and dripping.
Is supply voltage in accordance with the rated voltage marked on the nameplate?	It may cause electric malfunction or damage the part.
Is the electric wiring and piping connection installed correctly and securely?	It may cause electric malfunction or damage the part.
Has the unit been connected to a secure ground connection?	It may cause electrical leakage.
Is the power cord sized correctly?	It may cause electric malfunction or damage the part.
Has the air discharge and inlet been covered?	It may cause insufficient cooling(heating) capacity.
Has the length of connection pipes and refrigerant capacity been recorded?	The refrigerant capacity is not accurate.

Test Operation

1. Before test operation

- (1) Do not switch on power before installation is finished completely.
- (2) Electric wiring must be connected correctly and securely.
- (3) Cut-off valves of the connection pipes should be opened.
- (4) All scraps and waste from installation have been removed?

2. Test operation method

- (1) Switch on power, press "ON/OFF" button on the wireless remote control to start the operation.
- (2) Press MODE button, to select the COOL, HEAT, FAN to check whether the operation is normal or not.



F R I E D R I C H

Friedrich Air Conditioning Co.
10001 Reunion Place, Suite 500 • San Antonio, Texas 78216
1.800.541.6645
www.friedrich.com