



F R I E D R I C H

# Service Manual

---

Models: MWM09Y1J/MRM09Y1J  
MWM12Y1J/MRM12Y1J  
(Refrigerant R410A)

## Table of Contents

<b>Part I : Technical Information</b> .....	1
<b>1. Summary</b> .....	1
<b>2. Specifications</b> .....	2
2.1 Specification Sheet.....	2
2.2 Operation Characteristic Curve .....	4
2.3 Capacity Variation Ratio According to Temperature .....	4
2.4 Cooling and Heating Data Sheet in Rated Frequency .....	5
2.5 Noise Curve.....	5
<b>3. Outline Dimension Diagram</b> .....	6
3.1 Indoor Unit.....	6
3.2 Outdoor Unit.....	6
<b>4. Refrigerant System Diagram</b> .....	7
<b>5. Electrical Part</b> .....	8
5.1 Wiring Diagram.....	8
5.2 PCB Printed Diagram .....	10
<b>6. Function and Control</b> .....	12
6.1 Remote Controller Introduction .....	12
6.2 Brief Description of Modes and Functions.....	15
<b>Part II : Installation and Maintenance</b> .....	21
<b>7. Notes for Installation and Maintenance</b> .....	21
<b>8. Installation</b> .....	23
8.1 Installation Dimension Diagram.....	23
8.2 Installation Parts-checking .....	25
8.3 Selection of Installation Location.....	25
8.4 Electric Connection Requirement .....	25
8.5 Installation of Indoor Unit.....	25
8.6 Installation of Outdoor Unit.....	27
8.7 Vacuum Pumping and Leak Detection .....	29
8.8 Check after Installation and Test Operation .....	29

<b>9. Maintenance</b> .....	30
9.1 Error Code List .....	30
9.2 Troubleshooting for Main Malfunction .....	38
9.3 2-way, 3-way Valve Appearance.....	47
9.4 Troubleshooting for Normal Malfunction.....	54
<b>10. Exploded View and Parts List</b> .....	56
10.1 Indoor Unit.....	56
10.2 Outdoor Unit .....	58
<b>11. Removal Procedure</b> .....	60
11.1 Removal Procedure of Indoor Unit .....	60
11.2 Removal Procedure of Outdoor Unit .....	66
<b>Appendix:</b> .....	70
Appendix 1: Reference Sheet of Celsius and Fahrenheit .....	70
Appendix 2: Configuration of Connection Pipe.....	70
Appendix 3: Pipe Expanding Method .....	71
Appendix 4: List of Resistance for Temperature Sensor .....	72

# Part I : Technical Information

---

## 1. Summary

### Indoor Unit:

MWM09Y1J  
MWM12Y1J

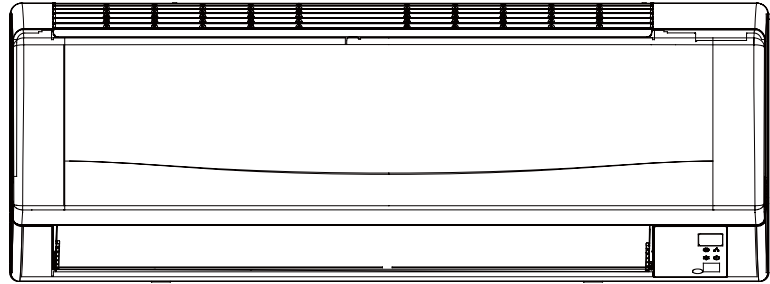

### Outdoor Unit:

MRM09Y1J  
MRM12Y1J

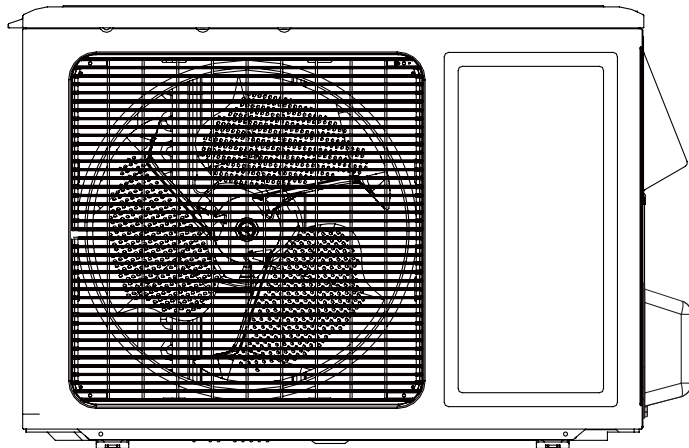

### Remote Controller:

YT1FF(MOTO2)



## 2. Specifications

### 2.1 Specification Sheet

Model			MWM09Y1J MRM09Y1J	MWM12Y1J MRM12Y1J
Product Code			CB146035101_L13396	CB146035001_L13396
Power Supply	Rated Voltage	V~	115	115
	Rated Frequency	Hz	60	60
	Phases		1	1
Power Supply Mode			Outdoor	Outdoor
Cooling Capacity (Min~Max)		Btu/h	9000(3500~11000)	11800(3300~12500)
Heating Capacity (Min~Max)		Btu/h	9800(2500~11000)	13000(3400~13500)
Cooling Power Input (Min~Max)		W	750(220~1100)	1260(260~1340)
Heating Power Input (Min~Max)		W	830(230~1230)	1320(250~1360)
Cooling Power Current		A	9	15
Heating Power Current		A	9.5	15.5
Rated Input		W	1230	1360
Rated Current		A	17.0	18.2
Air Flow Volume(SH/H/M/L/SL)		CMF	330/277/224/188/-	341/288/235/200/-
Dehumidifying Volume		Pint/h	1.69	2.96
EER		(Btu/h)/W	12	9.4
COP		(Btu/h)/W	12	9.8
SEER		(Btu/h)/W	16	16
HSPF		(Btu/h)/W	8.6	8.6
Application Area		yd <sup>2</sup>	14.4-21.5	19.14-28.7
Indoor Unit	Model of indoor unit		MWM09Y1J	MWM12Y1J
	Product Code		CB146N35100_L13396	CB146N35000_L13396
	Fan Type		Cross-flow	Cross-flow
	Diameter Length(DXL)		inch	Φ3 5/8X23 3/8
	Fan Motor Cooling Speed (SH/H/M/L/SL)		r/min	1300/1100/900/700/-
	Fan Motor Heating Speed (SH/H/M/L/SL)		r/min	1300/1150/980/820/-
	Output of Fan Motor		W	15
	Fan Motor RLA		A	0.38
	Fan Motor Capacitor		μF	4
	Input of Heater		W	/
	Evaporator Form			Aluminum Fin-copper Tube
	Pipe Diameter		inch	Φ2/7
	Row-fin Gap		inch	2-1/18
	Coil Length (LXDXW)		inch	24X17/18X11 4/7
	Swing Motor Model			MP24BA
	Output of Swing Motor		W	2.4
	Fuse		A	3.15
	Sound Pressure Level (SH/H/M/L/SL)		dB (A)	41/37/35/32/-
	Sound Power Level (SH/H/M/L/SL)		dB (A)	51/47/45/42/-
	Dimension (WXHXD)		inch	30 1/3X11 1/7X8
Dimension of Carton Box (LXWXH)		inch	33 2/9X13 1/2X10 2/7	
Dimension of Package (LXWXH)		inch	33 1/3X13 4/7X10 6/7	
Net Weight		lb	19	
Gross Weight		lb	23	

Outdoor Unit	Model of Outdoor Unit		MRM09Y1J	MRM12Y1J
	Product Code		CB146W0431_L13396	CB146W0451_L13396
	Compressor Manufacturer/Trademark		ZHUHAI LANDA COMPRESSOR CO., LTD	ZHUHAI LANDA COMPRESSOR CO., LTD
	Compressor Model		QXA-A091ZE190	QXA-A091ZE190
	Compressor Oil		FVC68D	FVC68D
	Compressor Type		Rotary	Rotary
	L.R.A.	A	/	/
	Compressor RLA	A	6	6
	Compressor Power Input	W	980	980
	Overload Protector		1NT11L-6233	1NT11L-6233
	Throttling Method		Electron expansion valve	Electron expansion valve
	Operation temp	°F	61~86	61~86
	Ambient temp (cooling)	°F	64~113	64~113
	Ambient temp (heating)	°F	5~75	5~75
	Condenser Form		Aluminum Fin-copper Tube	Aluminum Fin-copper Tube
	Pipe Diameter	inch	Φ2/7	Φ2/7
	Rows-fin Gap	inch	2-1/18	2-1/18
	Coil Length (LXDXW)	inch	29 8/11X19 8/17	29 8/11X19 8/17
	Fan Motor Speed	rpm	900	900
	Output of Fan Motor	W	30	30
	Fan Motor RLA	A	0.17	0.17
	Fan Motor Capacitor	μF	/	/
	Air Flow Volume of Outdoor Unit	CFM	1059	1059
	Fan Type		Axial-flow	Axial-flow
	Fan Diameter	inch	Φ15 10/13	Φ15 10/13
	Defrosting Method		Auto Defrosting	Auto Defrosting
	Climate Type		T1	T1
	Isolation		I	I
	Moisture Protection		IP24	IP24
	Design Pressure(High)	PSIG	550	550
	Design Pressure(Low)	PSIG	240	240
	Sound Pressure Level (H/M/L)	dB (A)	53/-/-	55/-/-
	Sound Power Level (H/M/L)	dB (A)	63/-/-	65/-/-
Dimension (WXHXD)	inch	33 2/5X21 1/4X12 3/5	33 2/5X21 1/4X12 3/5	
Dimension of Carton Box (LXWXH)	inch	34 4/7X14 1/6X22 5/6	34 4/7X14 1/6X22 5/6	
Dimension of Package (LXWXH)	inch	34 2/3X14 2/7X23 3/7	34 2/3X14 2/7X23 3/7	
Net Weight	lb	68	68	
Gross Weight	lb	77	77	
Refrigerant		R410A	R410A	
Refrigerant Charge	oz	35.28	35.28	
Connection Pipe	Length	ft	24.6	24.6
	Gas Additional Charge	oz/ft.	0.21	0.21
	Outer Diameter Liquid Pipe	inch	Φ1/4	Φ1/4
	Outer Diameter Gas Pipe	inch	Φ3/8	Φ3/8
	Max Distance Height	ft	32.8	32.8
	Max Distance Length	ft	49.2	49.2

The above data is subject to change without notice. Please refer to the nameplate of the unit.

## 2.2 Operation Characteristic Curve

Cooling

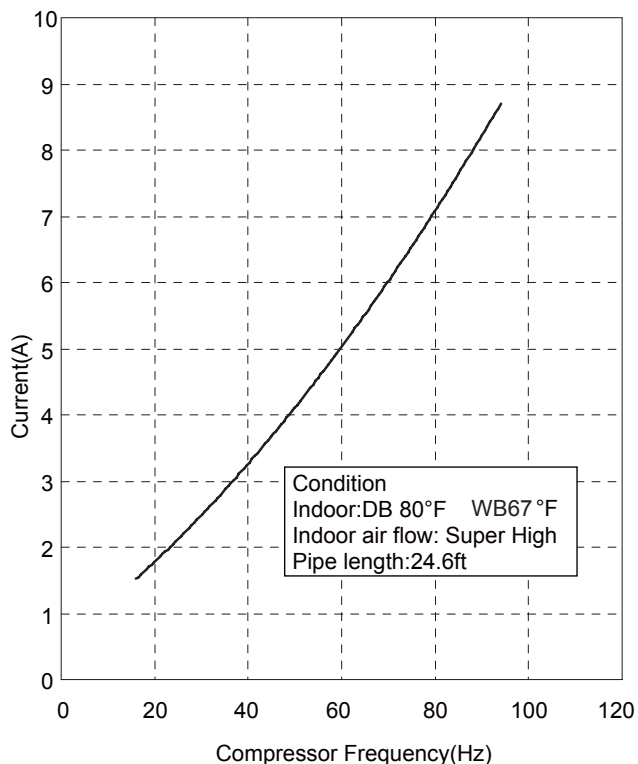

Heating

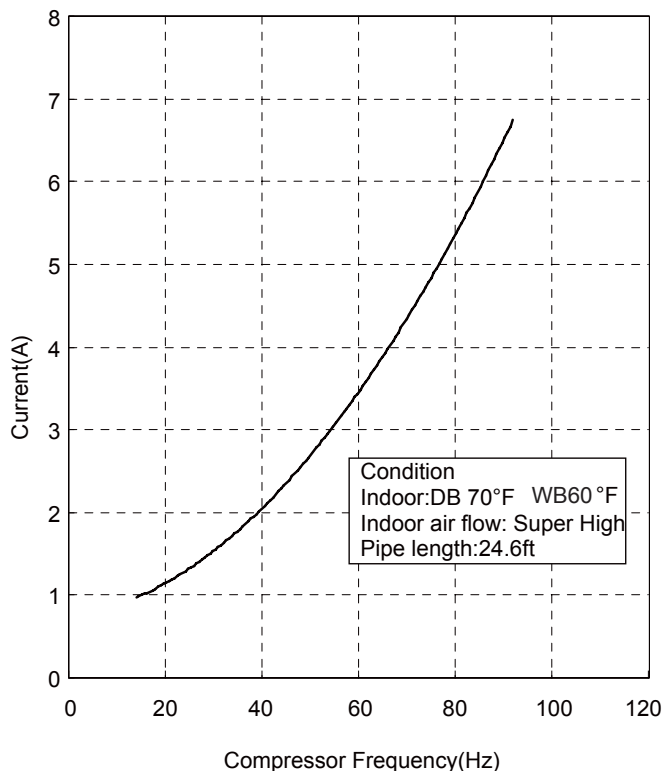

## 2.3 Capacity Variation Ratio According to Temperature

Cooling

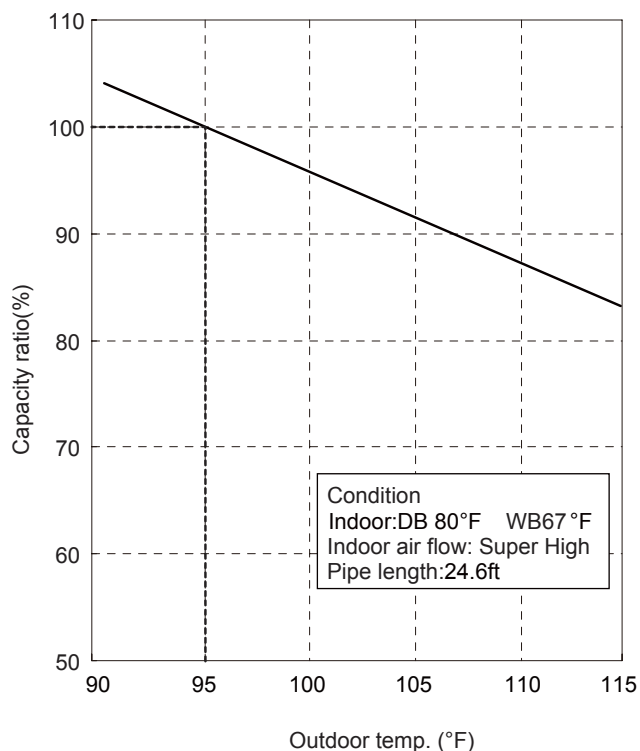

Heating

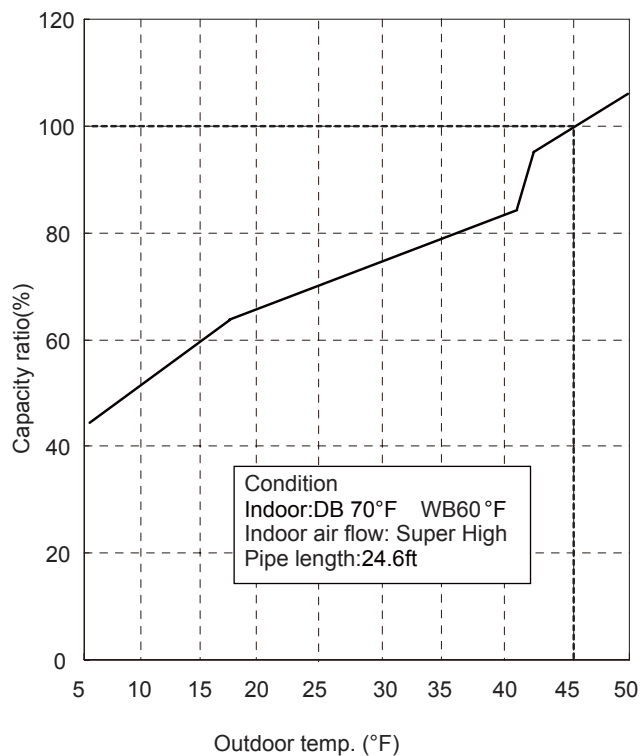

## 2.4 Cooling and Heating Data Sheet in Rated Frequency

Cooling:

Rated cooling condition(°F) (DB/WB)		Model	Pressure of gas pipe connecting indoor and outdoor unit	Inlet and outlet pipe temperature of heat exchanger		Fan speed of indoor unit	Fan speed of outdoor unit	Compressor frequency (Hz)			
Indoor	Outdoor			T1 (°F)	T2 (°F)						
80/67	95/-	MWM09Y1J	0.8~1.1	54 to 57	106 to 109	Super High	High	48			
		MRM09Y1J									
		MWM12Y1J		50 to 54	109 to 113				Super High	High	77
		MRM12Y1J									

Heating:

Rated heating condition(°F) (DB/WB)		Model	Pressure of gas pipe connecting indoor and outdoor unit	Inlet and outlet pipe temperature of heat exchanger		Fan speed of indoor unit	Fan speed of outdoor unit	Compressor frequency (Hz)			
Indoor	Outdoor			T1 (°F)	T2 (°F)						
70/60	47/43	MWM09Y1J	37~38	98 to 100	36 to 39	Super High	High	54			
		MRM09Y1J									
		MWM12Y1J		107 to 111	32 to 37				Super High	High	78
		MRM12Y1J									

**Instruction:**

T1: Inlet and outlet pipe temperature of evaporator

T2: Inlet and outlet pipe temperature of condenser

P: Pressure at the side of big valve

Connection pipe length: 24.6ft.

## 2.5 Noise Curve

Indoor side noise when blowing

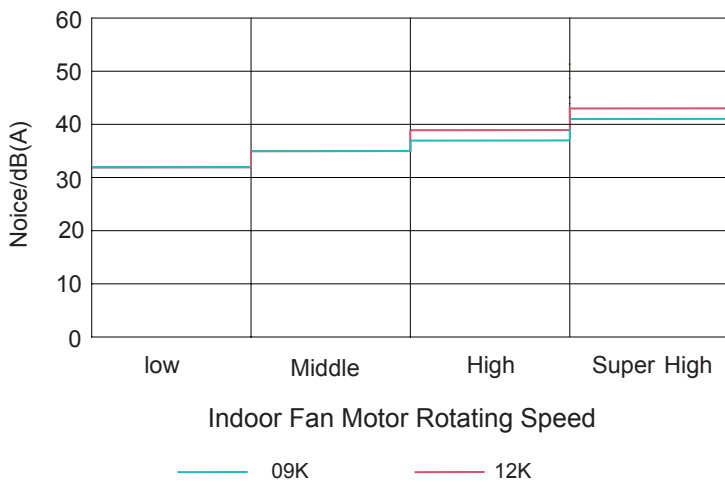

Outdoor side noise when blowing

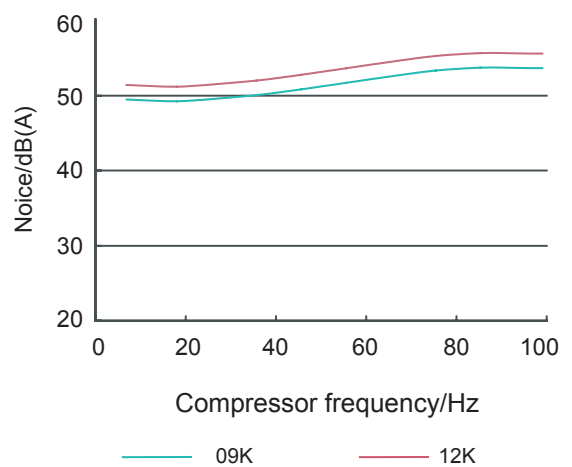



### 3. Outline Dimension Diagram

#### 3.1 Indoor Unit

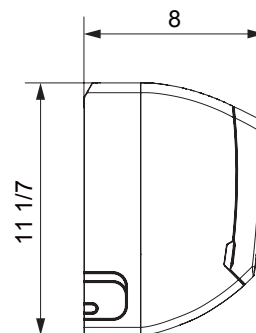
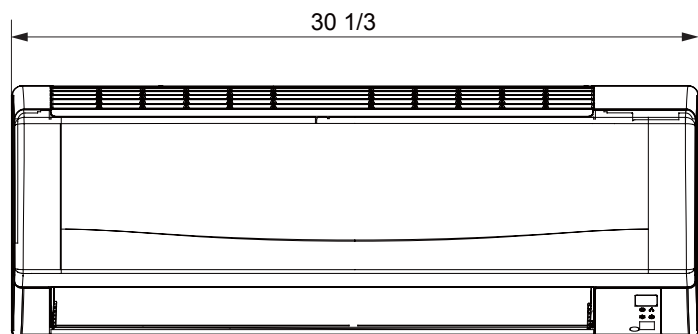

MWM09Y1J MWM12Y1J

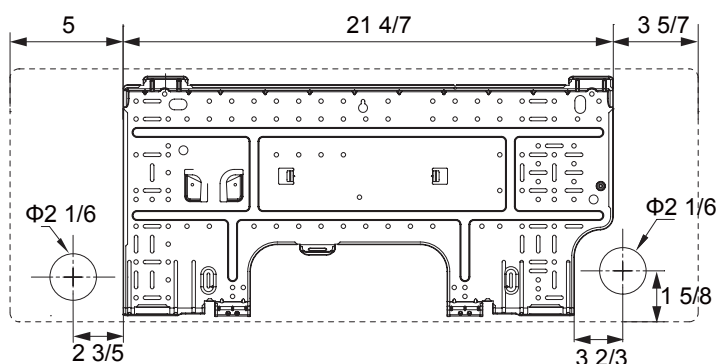

Unit: inch

#### 3.2 Outdoor Unit

MRM09Y1J MRM12Y1J

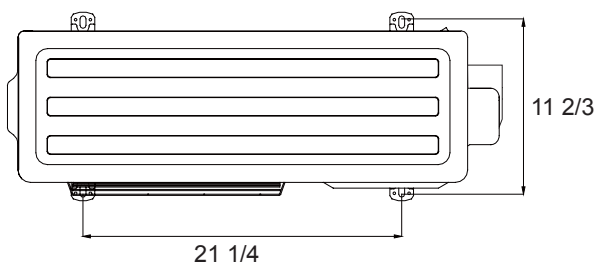
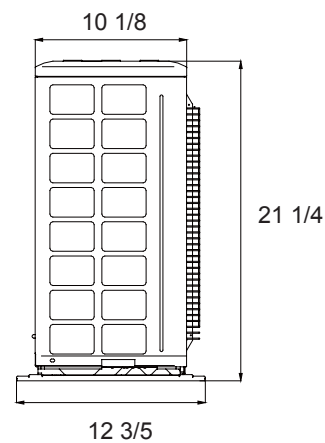
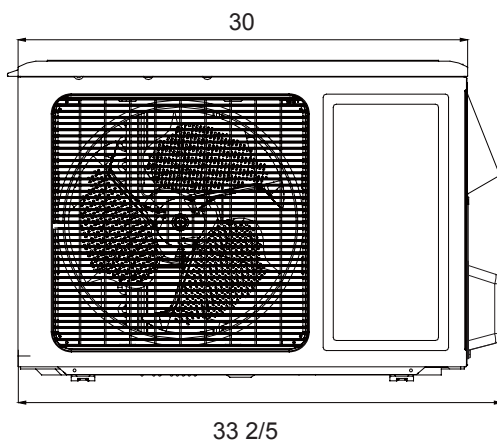
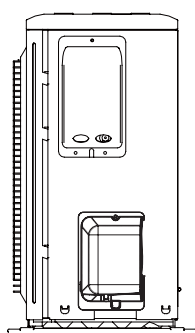

Unit: inch

# 4. Refrigerant System Diagram

Cooling & Heating Models

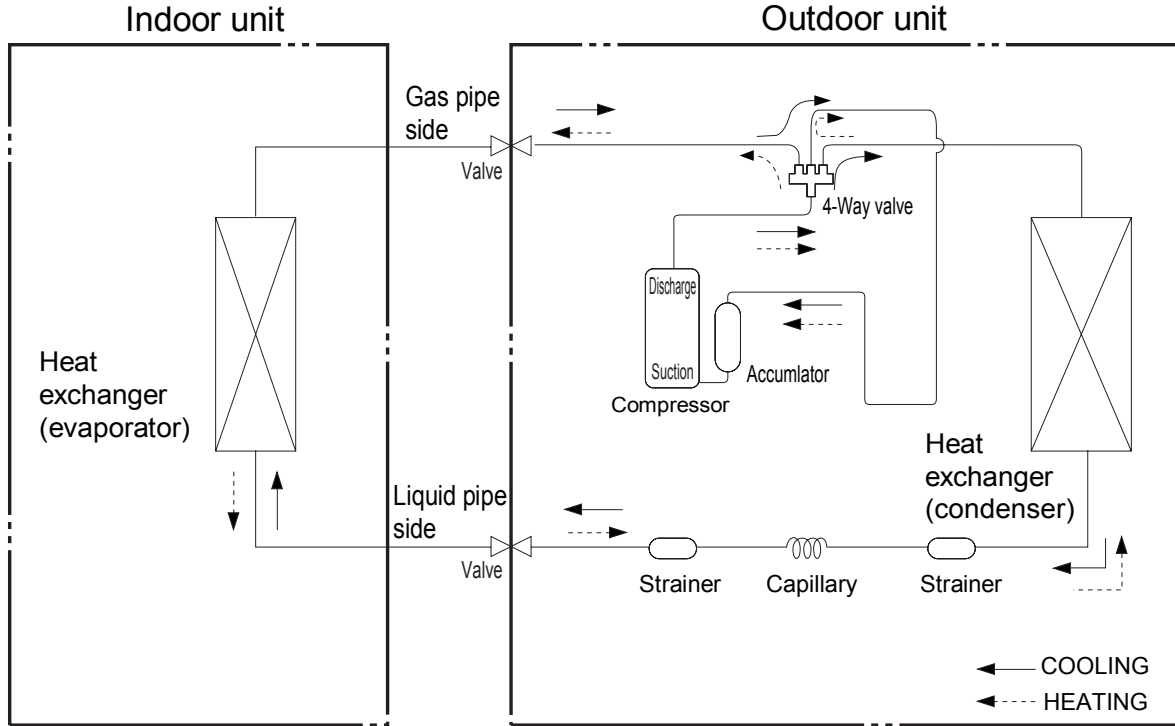

Refrigerant pipe diameter  
Liquid :1/4" Gas : 3/8"

## 5. Electrical Part

### 5.1 Wiring Diagram

● **Instruction**

Symbol	Symbol Color	Symbol	Symbol Color	Symbol	Name
WH	White	GN	Green	CAP	Jumper cap
YE	Yellow	BN	Brown	COMP	Compressor
RD	Red	BU	Blue	⊕	Grounding wire
YEGN	Yellow/Green	BK	Black	/	/
VT	Violet	OG	Orange	/	/

Note: Jumper cap is used to determine fan speed and the swing angle of horizontal lover for this model.

● **Indoor Unit**

MWM09Y1J MWM12Y1J

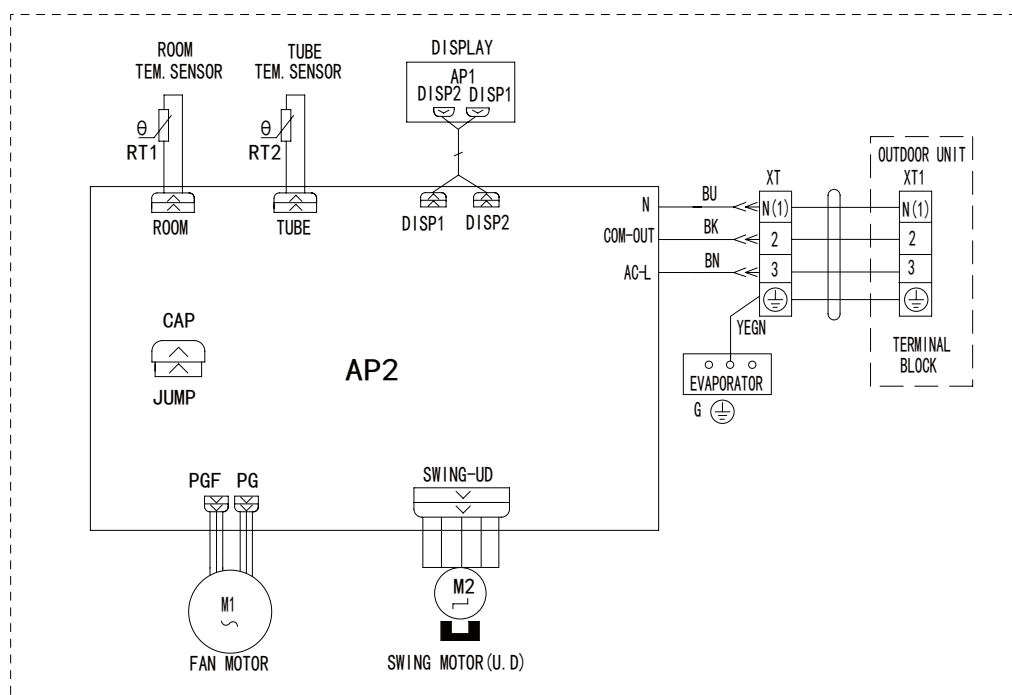

• Outdoor Unit

MRM09Y1J MRM12Y1J

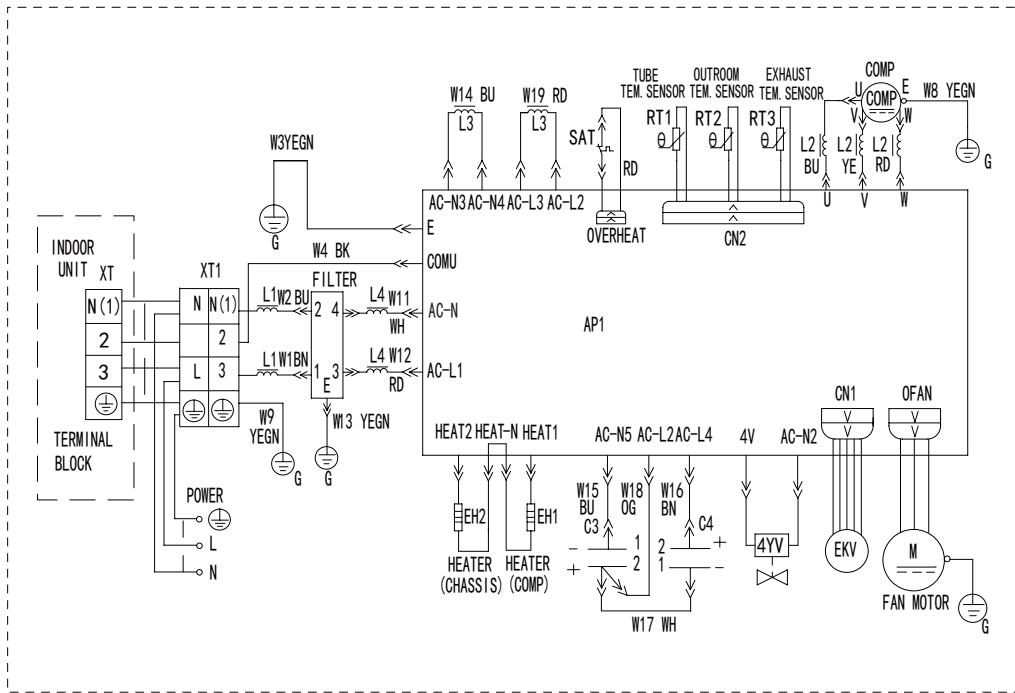

These circuit diagrams are subject to change without notice, please refer to the one supplied with the unit.

## 5.2 PCB Printed Diagram

### Indoor Unit

#### • Top view

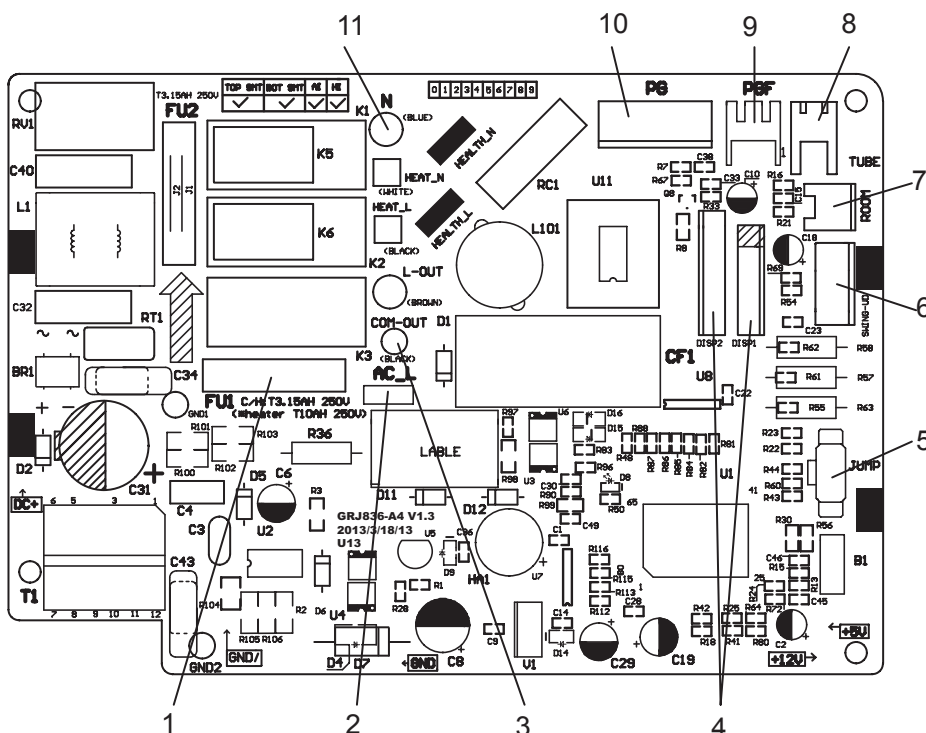

NO.	Name
1	Fuse
2	Live wire
3	Communication wire
4	Display interface
5	Jumper cap
6	Up and down swing
7	Ambient temperature sensor
8	Temperature sensor
9	PG feedback
10	PG motor
11	Neutral wire

#### • Bottom view

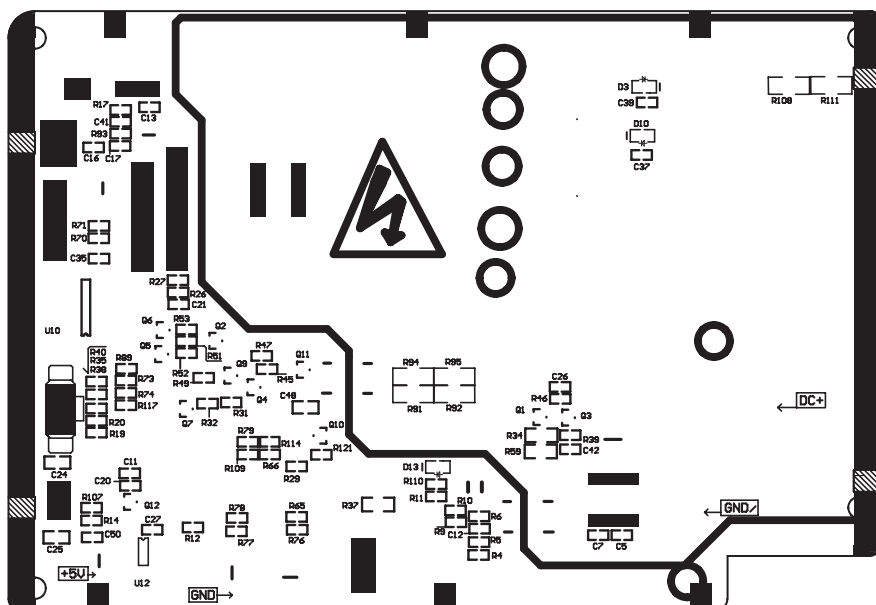

### Outdoor Unit

● Top view

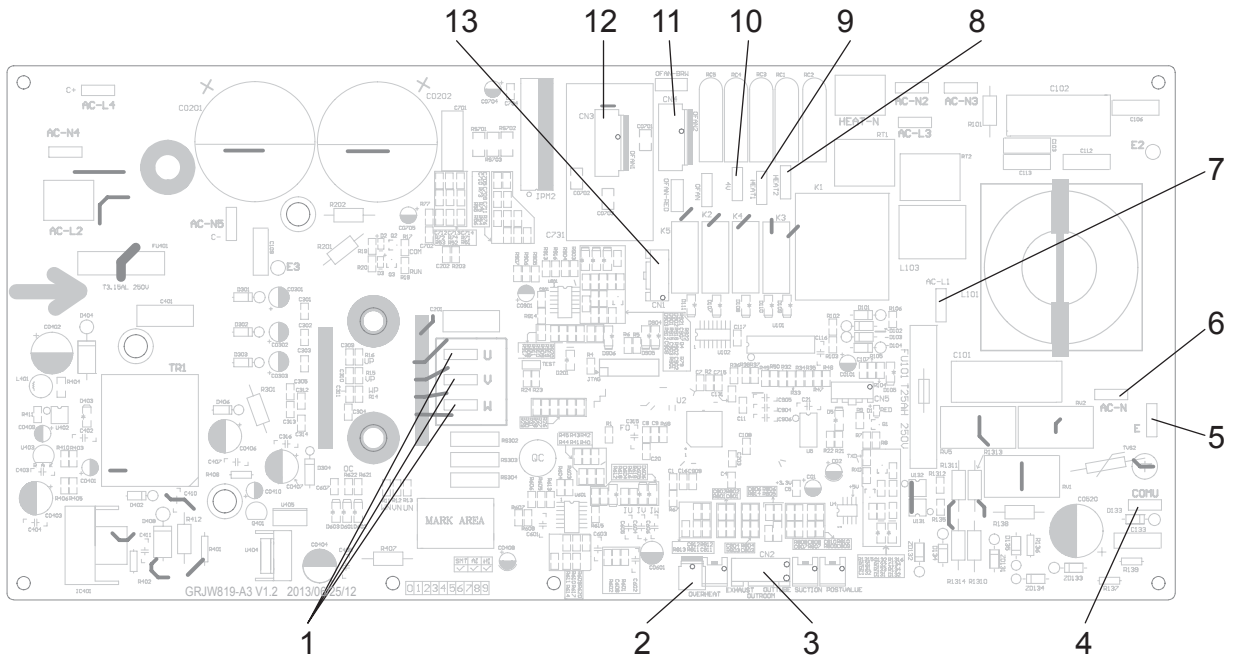

NO.	Name	NO.	Name	NO.	Name
1	Compressor output port	6	Port of power neutral wire	11	Port of AC fan motor
2	Overload port	7	Live wire	12	Port of DC fan motor
3	Temperature sensor port	8	Port of compressor electric heating belt	13	Port of electronic expansion valve
4	Communication wire port	9	Port of compressor electric heating belt	/	/
5	Earthing wire port	10	Port of AC fan motor	/	/

● Bottom view

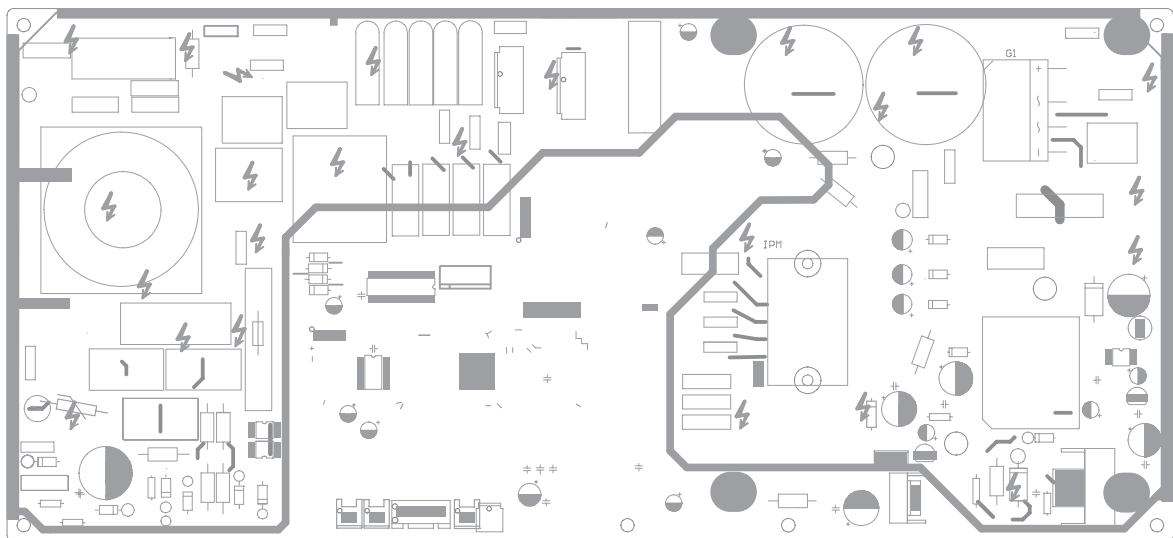

## 6. Function and Control

### 6.1 Remote Controller Introduction

#### Buttons on Remote Controller



#### Introduction for Icons on Display Screen

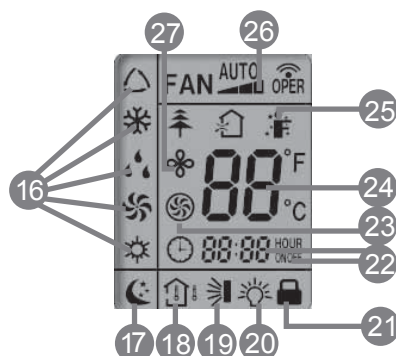

- 1 START / STOP: Press to start or stop operation.
- 2 ▼ : Press to decrease temperature setting.
- 3 ▲ : Press to increase temperature setting.
- 4 FAN AUTO: Press to set fan speed.
- 5 MODE: Press to select operation mode (AUTO/COOL/DRY/FAN/HEAT).
- 6 SENSOR
- 7 CLOCK: Press it set clock.
- 8 TIMER ON: Press it to set auto-on timer.
- 9 AIR SWEEP: Press it set swing angle.
- 10 EXTEND
- 11 TEMP
- 12 TIMER OFF: Press it to set auto-off timer.
- 13 TURBO
- 14 SLEEP
- 15 LIGHT: Press it to turn on/off the light.
- 16 MODE icon: If MODE button is pressed, current operation mode icon △ (AUTO), ❄️ (COOL), 💧 (DRY), 🌀 (FAN) or ☀️ (HEAT) (only for heat pump models) will show.
- 17 SLEEP icon : 🌙 is displayed by pressing the SLEEP button. Press this button again to clear the display.
- 18 TEMP icon: Pressing TEMP button, ⬆️ (set temperature), ⬆️ (indoor ambient temperature), ⬆️ (outdoor ambient temperature) and blank is displayed circularly.
- 19 AIR SWEEP icon: 🌀 is displayed when pressing the AIR SWEEP button. Press this button again to clear the display.
- 20 LIGHT icon: 💡 is displayed by pressing the LIGHT button. Press LIGHT button again to clear the display.
- 21 LOCK icon: 🗑️ is displayed by pressing “▼” and “▲” buttons simultaneously. Press them again to clear the display.
- 22 SET TIME display: After pressing TIMER button, ON or OFF will blink. This area will show the set time.
- 23 TURBO icon: 🌀 is displayed when pressing the TURBO button. Press this button again to clear the display.
- 24 DIGITAL display: This area will show the set temperature.
- 25 SENSOR icon: 🌡️ is displayed when pressing the SENSOR button. Press this button again to clear the display.
- 26 FAN SPEED display: Press FAN button to select the desired fan speed setting (AUTO-Low-Med-High). Your selection will be displayed in the LCD windows, except the AUTO fan speed.
- 27 EXTEND icon: 🌀 is displayed when pressing the EXTEND button. Press this button again to clear the display.

## Introduction for Buttons on Remote Controller

### 1. START / STOP: button

Press this button to turn on the unit .Press this button again to turn off the unit.



### 2. "▼" :

Press this button to decrease set temperature. Hold it down for 2 seconds or more to rapidly decrease set temperature. In AUTO mode, set temperature is not adjustable.

### 3. "▲" :

Press this button to increase set temperature. Hold it down for 2 seconds or more to rapidly increase set temperature. In AUTO mode, set temperature is not adjustable.

### 4. FAN AUTO button

This button is used for setting Fan Speed in the sequence that goes from AUTO,  ,  , to  , then back to Auto.



### 5. MODE button

Each time you press this button, a mode is selected in a sequence that goes from AUTO,COOL,DRY, FAN,and HEAT , as the following:





Note: Only for models with heating function.

After energization, AUTO mode is defaulted. In AUTO mode, the set temperature will not be displayed on the LCD, and the unit will automatically select the suitable operation mode in accordance with the room temperature to make indoor room comfortable.

### 6. SENSOR (SAVE) button

Press this button to turn on SENSOR(SAVE) function. Saves room ambient temperature and automatically adjusts maintaining that room ambient until pressed again which cancels the SENSOR(SAVE) function.

### 7. CLOCK button

Pressing CLOCK button,  blinks. Within 5 seconds, pressing + or - button adjusts the present time. Holding down either button above 2 seconds increases or decreases the time by 1 minute every 0.5 second and then by 10 minutes every 0.5 second. During blinking after setting, press CLOCK button again to confirm the setting, and then  will be constantly displayed.

### 8. TIMER ON button





Press this button to initiate the auto-ON timer. To cancel the auto-timer program, simply press this button again.

After pressing this button,  disappears and " ON " blinks. 00:00 is displayed for ON time setting. Within 5 seconds, press ▲ or ▼ button to adjust the time value. Every press of either button changes the time setting by 1 minute. Holding down either button rapidly changes the time setting by 1 minute and then 10 minutes. Within 5 seconds after setting, press TIMER ON button to confirm.

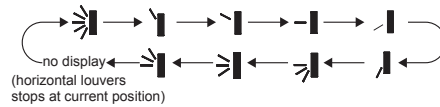
### 9. AIR SWEEP button

Press this button to set up & down swing angle, which circularly changes as below:



This remote controller is universal. If any command ,  or  is sent out, the unit will carry out the command as  .  indicates the guide louver swings as:

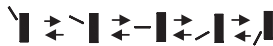

### 10. EXTEND(DRY) button

Pressing EXTEND button in COOL or DRY mode, the icon  is displayed and the indoor fan will continue operation for 10 minutes in order to dry the indoor unit even though you have turned off the unit.

After energization, EXTEND OFF is defaulted. EXTEND is not available in AUTO, FAN or HEAT mode.

### 11. TEMP button

By pressing this button you can display the indoor setting temperature or indoor ambient temperature. When the indoor unit is first powered on it will display the setting temperature, if the temperature's display status is changed from other status to "" , displays the ambient temperature, 5s later or within 5s, it receives other remote control signal that will return to display the setting temperature. If the users haven't set up the temperature displaying status, that will display the setting temperature. (This function is not applicable for some models).

### 12. TIMER OFF button

Press this button to initiate the auto-off timer. To cancel the auto-timer program, simply press the button again. TIMER OFF setting is the same as TIMER ON.



**13. TURBO button**

Press this button to activate / deactivate the Turbo function which enables the unit to reach the preset temperature in the shortest time. In COOL mode, the unit will blow strong cooling air at super high fan speed. In HEAT mode, the unit will blow strong heating air at super high fan speed. (This function is not applicable for some models).



**14. SLEEP button**

Press this button to go into the SLEEP operation mode. Press it again to cancel this function. This function is available in COOL or DRY mode to maintain the most comfortable temperature for you.

**15. LIGHT button**

Press LIGHT button to turn on the display's light and press this button again to turn off the display's light. If the light is turned on,  is displayed. If the light is turned off,  disappears.

**Combination of "▲" and "▼" buttons: About lock**

Press "▲" and "▼" buttons simultaneously to lock or unlock the keypad. If the remote controller is locked,  is displayed. In this case, pressing any button,  blinks three times.

**Combination of "MODE" and "-" buttons:**

Allows you to toggle between Fahrenheit and Celsius. When the unit is OFF, press "MODE" and "-" buttons simultaneously to switch between °C and °F.

**Replacement of Batteries in Remote Controller**

1. Press the back side of remote controller marked with  as shown in the fig, and then push out the cover of battery box along the arrow direction.
2. Replace two 7# (AAA 1.5V) dry batteries, and make sure the position of "+" polar and "-" polar are correct.
3. Reinstall the cover of battery box.

**Note:**

- During operation, point the remote control signal sender at the receiving window on indoor unit.
- The distance between signal sender and receiving window should be no more than 8m, and there should be no obstacles between them.
- Signal may be interfered easily in the room where there is fluorescent lamp or wireless telephone; remote controller should be close to indoor unit during operation.
- Replace new batteries of the same model when replacement is required.
- When you don't use remote controller for a long time, please take out the batteries.
- If the display on remote controller is fuzzy or there's no display, please replace batteries.

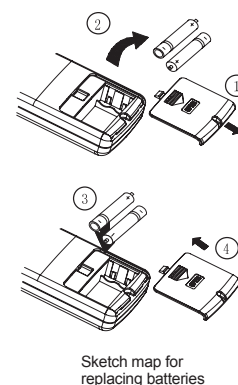

## 6.2 Brief Description of Modes and Functions

### (1)Cooling Mode

1. When room temp-set temp  $\leq -3.6^{\circ}\text{F}$  , cooling will stop; Outdoor fan will stop later and indoor fan will operate at set speed;

2. When room temp –set temp  $> -3.6^{\circ}\text{F}$ , if such situation continues for a period of time, cooling operation will be started. In that case, indoor fan, outdoor fan and compressor will operate and the indoor fan will operate at set speed.

\* In this mode, fan and swing motor will operate at set status and the temp range setting is 61~86°F.

\* If there is malfunction of outdoor unit or the unit stops for protection, the indoor unit will keep its operation status but the error will be displayed.

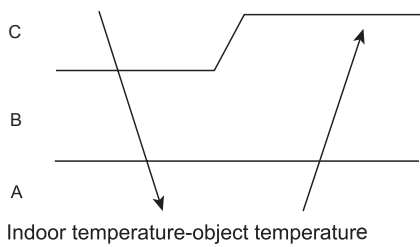

### (2)Dry Mode

1. In this mode, the fan motor runs at low fan speed while swing works according to setting state. The range of setting temperature is 61~86°F.

2. When outdoor unit has malfunction or stopped for protection, the indoor fan will keep the original running state and the error will be displayed.

### (3)Fan Mode

1. In this mode, the indoor fan may run at high, medium, low and automatic speed. The compressor, outdoor fan and 4-way valve all stop running.

2. In this mode, the range of setting temperature is 61~86°F.

### (4)Heat Mode

#### 1.Heating mode

When setting temperature-indoor temperature  $\leq 29.3^{\circ}\text{F}$ .the unit will stop heating. Both outdoor fan and indoor fan will stop later.

When setting temperature-indoor temperature  $> 29.3^{\circ}\text{F}$  and it lasts for a certain period, the unit will start heating. In that case, indoor fan, outdoor fan and compressor will start running. The indoor fan works according to the anti-cold air.

\* In this mode, the range of setting temperature is 61~86°F.

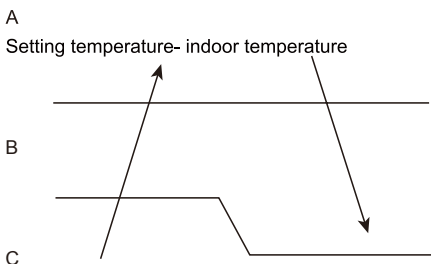

2.Protection function: in heating mode, when the compressor stops as a result of malfunction, the indoor fan blows residual heat.

3.Defrosting control: when the defrosting signal is revived,defrosting

mark H1 will be shown. The e-heater and indoor fan stop.

### \*Anti-cold air function

The rotational speed of indoor electromotor is decided based on the indoor pipe temperature. The indoor fan can run at low speed or stop running. This function will terminate after the unit runs for 3min or the pipe temperature reached certain value.

During heating, if the indoor pipe temperature is lower than certain value.The running speed of indoor fan will decrease automatically base on the pipe temperature and ensure that the outlet air is hot.

### \*Residual heat blowing function

During heating, when the stopping condition for the compressor is reached,the compressor and the outdoor fan motor stop running while the upper and lower air deflector rotate to level L. the indoor fan will stop after running for 60s at setting speed.

### (5)Auto Changeover Mode

In this mode, the system selects the operation mode (cooling and fan) automatically according to the ambient temperature. The display shows the actual operation mode and setting temperature. There will be 30s delay for mode conversion. The protection function is the same as that of other modes.

1. When  $T_{\text{amb.}} \geq 77^{\circ}\text{F}$  , the cooling mode is selected.

2. for cooling only unit: when  $T_{\text{amb.}} < 71.6^{\circ}\text{F}$ , the unit runs in fan mode.

3. When  $71.6^{\circ}\text{F} < T_{\text{indoor amb.}} < 77^{\circ}\text{F}$ , upon initial startup, the unit will enter auto mode and run in automatic fan mode. If the other mode changes to auto mode, the previous operation mode will remain.

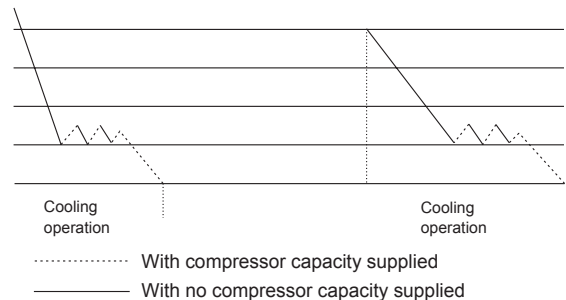

### (6)Auto fan speed Mode

In auto fan mode, the rotational speed of the fan for indoor unit is decided by the differential temperature between ambient temperature and set temperature. In dry mode, the automatic fan speed is forced to be low.

No. of jumper cap	Unit type	Mode	Turbo	High fan speed	Medium fan speed	Low fan speed
1	09K	Rotational speed during cooling	1300	1100	900	700
		Rotational speed during heating	1300	1150	980	820
2	12K	Rotational speed during cooling	1350	1150	950	750
		Rotational speed during heating	1350	1200	1000	850

### (7)Lower Control

After energization, the swing motor will open the horizontal louver to be open and then be close completely. And the air outlet is close.

In heating mode, if the swing function is not set, the horizontal louver will rotate to maximum in clockwise direction. Then it will

rotate to place D. Under other state, the horizontal louver will rotate to level L. If the swing function is set when starting the unit, the horizontal louver will swing between place L and D. there are 7 states for the louver: in Place L, Place A, Place B, Place C, Place D, and swing between Place L and place D, stop in any place between Place L and place D. When the unit is turned off, the louver will stay in place 0. The swing is available only, when the swing function is set and the indoor fan is running.

Note: When place L to B, place A to C, and place B and D is set, the horizontal louver will swing between place L to D. L↔A↔B↔C↔D

#### (8) Sleep Function

Sleeping mode is available only in cooling and heating modes;

Cooling mode: at the base of initial set temperature by remote controller, the set temperature will increase automatically according to people's coziness within several hours after setting sleep function.

Heating mode: at the base of initial set temperature by remote controller, the set temperature will decrease automatically according to people's coziness within several hours after setting sleep function.

#### (9) Timer Function

The main board has general timer function and clock function. The timer function can be selected by remote controller with different function

1.General timer (start and stop time can be set. The accuracy is minute. E.g.: timer on for 1 hour; timer off for 1.5 hours.)

Timer on: after setting timer on, the unit will run at setting time according to the original setting mode. The timing interval is 0.5hour, and the setting range is 0.5~24hours.

Timer off: the timer off function can be set when the unit is on. When the setting time for timer off is reached, the unit will stop. The timing interval is 0.5hour, and the setting range is 0.5~24hours.

2.Clock (start and stop time can be set. The accuracy is minute. E.g.: timer on at 8:00a.m.; timer off at 17:30p.m.)

Timer on: if the timer on function is set when the system is on, the system will go on running. If the timer on function is set when the system is off, the system will start running in the previously set mode when the setting time is reached.

Timer off: if the timer off function is set when the system is off, the system will keep off even though the setting time is reached. If the timer off function is set when the system is on, the system will stop running when the setting time is reached.

Timer modification: when the system is under timer state, start or stop of the unit can be set via remote ON/OFF button and the timer can be reset. The system runs according to the latest setting state.

When both the timer on and timer off are set: the system runs according to the current setting state. When the setting time is reached, the unit will start and stop running. In that case, the unit will run according to the previously setting mode when the setting time for timer on is reached. The unit will stop running while the setting time for timer off is reached.

If the setting time for timer on and timer off is the same, the unit will stop running no matter what the current state is.

#### (10) Auto-Restart Function

Memory: mode, up and down swing, light, setting temperature, setting fan speed, general timer (not clock), Fahrenheit / Celsius. After de-energized, the unit can run according to the memory if it is energized again. If the timer function is not set in the last remote control, the system will run according to the last remote control. If the timer function is set in the last control before it is de-energized, the system will memorize the last timer setting. The setting time is recalculated since the energization of the unit. If the timer function is set in the last control and the setting time is reached before the unit is de-energized, the unit will run according to the previous running mode after it is energized again. But the timer function will terminate. The clock will not be memorized.

In cooling and heating mode (not available in auto, dehumidify, fan mode), press the Turbo button, the fan speed displayed super high speed in the remote controller and the indoor fan rotates at super high speed.

#### (11) Turbo Function

In cooling and heating mode (not available in auto, dehumidify, fan mode), press the Turbo button, the fan speed displayed super high speed in the remote controller and the indoor fan rotates at super high speed.

#### (12) Health Function

When the indoor fan motor is running, the Health function is set by pressing remote controller (If there is no Health button on the remote controller, the health function opening is defaulted).

#### (13) I Feel Function

If the remote controller receives the I Feel order, the controller will work at the ambient temperature value which is sent by remote controller (Except the defrosting and anti-cool wind, which still adopts the sampling value of AC itself ambient temperature sensor), the remote controller will send ambient temperature value to controller every 10mins. After 11mins, if the controller hasn't received the ambient temperature value from the remote controller for long time, then it will run according to the current ambient temperature of AC.

If the function has not been set, the ambient temperature will adopt the sensor sampling value of AC itself. If power off happens, this function will not be memorized.

## Troubleshooting of Temperature Sensor

### (1) Indoor Temperature Sensor

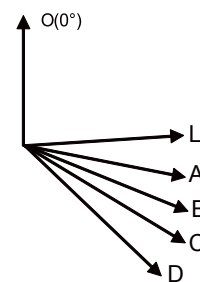

Detect malfunctions of temperature sensor any time.

(2) Indoor Pipe Temperature Sensor

In defrosting period, the temperature sensor malfunction will not be detected. 5 min after finishing defrosting, the system begins to detect the temperature sensor malfunction. In other times, the temperature sensor malfunction will be detected.

(3) Protection of Temperature Sensor

1. When short-circuit occurs to the temperature sensor for 30s:

The temperature sensor overheats. In this case, the complete unit will stop for protection. At the same time, the temperature protection and temperature sensor malfunction will be shown.

2. When break-circuit occurs to the temperature sensor for 30s:

The unit will stop and the temperature sensor malfunction will be displayed.

Frequency Control

Frequency Initial Setting<Outline>When starting the compressor, or when conditions are varied due to the change of the room, the frequency must be initialized according to the  $\Delta D$  value of the indoor unit and the Q value of the indoor unit. Q value: Indoor unit output determined from indoor unit volume, air flow rate and other factors. PI Control (Determine Frequency Up / Down by  $\Delta D$  Signal)

1. P control Calculate  $\Delta D$  value in each sampling time (20 seconds), and adjust the frequency according to its difference from the frequency previously calculated.

2. I control If the operating frequency is not change more than a certain fixed time, adjust the frequency up and down according to the  $\Delta D$  value, obtaining the fixed  $\Delta D$  value.

When the  $\Delta D$  value is small lower the frequency.

When the  $\Delta D$  value is large increase the frequency.

3. Frequency management when other controls are functioning When frequency is drooping; Frequency management is carried out only when the frequency droops. For limiting lower limit Frequency management is carried out only when the frequency rises.

4. Upper and lower limit of frequency by PI control The frequency upper and lower limits are set depending on indoor unit. When low noise commands come from the indoor unit or when outdoor unit low noise or quiet commands come from indoor unit, the upper limit frequency must be lowered than the usual setting.

3-minutes Standby

Prohibit to turn ON the compressor for 3 minutes after turning it off. (except when defrosting)

Compressor Protection Function

When turning the compressor from OFF to ON, the upper limit of frequency must be set as follows. (The function must not be used when defrosting.)

FCG 3	88
FCG 2	64
FCG 1	48
TCG1	240
TCG2	360
TCG3	180

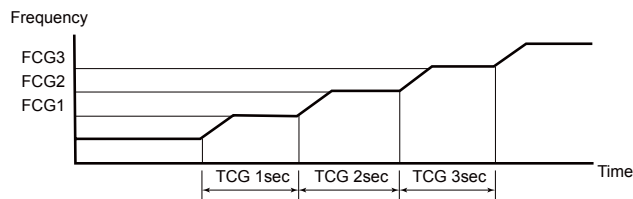

Discharge Pipe Control

Outline

The discharge pipe temperature is used as the compressor's internal temperature. If the discharge pipe temperature rises above a certain level, the operating frequency upper limit is set to keep this temperature from going up further.

Detail

Divide the Zone

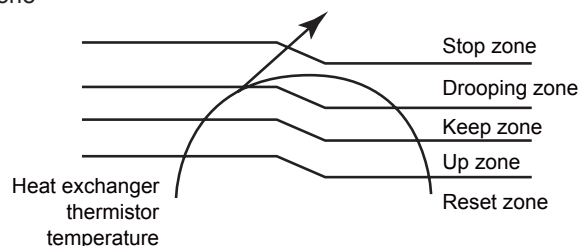

Management within the Zones

Zone	Control contents
Stop zone	When the temperature reaches the stop zone, stop the compressor and correct abnormality.
Drooping zone	Start the timer, and the frequency will be drooping.
Keep zone	Keep the upper limit of frequency.
Return / Reset zone	Cancel the upper limit of frequency.

## Input Current Control

### Outline

Detect an input current by the CT during the compressor is running, and set the frequency upper limit from such input current. In case of heat pump model, this control is the upper limit control function of the frequency which takes priority of the lower limit of four way valve activating compensation.

### Detail

The frequency control will be made within the following zones.

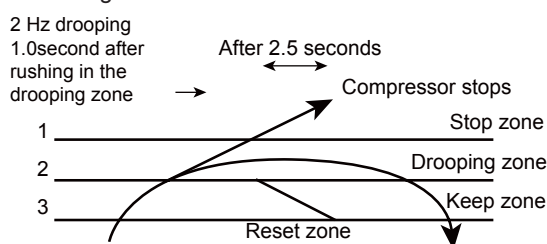

When a “stop current” continues for 2.5 seconds after rushing on the stop zone, the compressor operation stops. If a “drooping current” is continues for 1.0 second after rushing on the drooping zone, the frequency will be 2 Hz drooping. Repeating the above drooping continues until the current rushes on the drooping zone without change. In the keep zone, the frequency limit will remain.

In the return / reset zone, the frequency limit will be cancelled.

Limitation of current drooping and stop value according to the outdoor air temperature

1. In case the operation mode is cooling
  - \* The current droops when outdoor air temperature becomes higher than a certain level (model by model).
2. In case the operation mode is heating
  - \* The current droops when outdoor air temperature becomes higher than a certain level (model by model).

## Freeze-up Protection Control

### Outline

During cooling operation, the signals being sent from the indoor unit allow the operating frequency limitation and then prevent freezing of the indoor heat exchanger. (The signal from the indoor unit must be divided into the zones as the followings.)

### Detail

#### 1. Conditions for Start Controlling

Judge the controlling start with the indoor heat exchanger temperature after 2 sec from operation start.

#### 2. Control in Each Zone

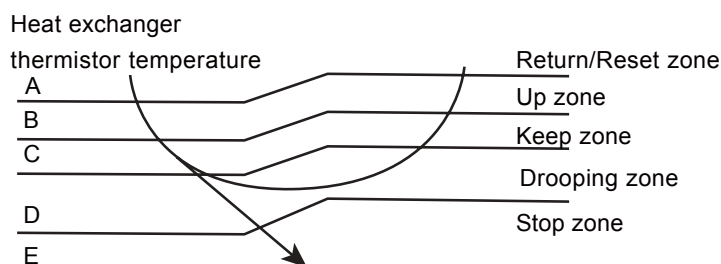

## Heating Peak-cut Control

### Outline

#### Heat Pump Only

During heating operation, the signals being sent from the indoor unit allow the operating frequency limitation and prevent abnormal high pressure. (The signal from the indoor unit must be divided as follows.)

### Detail

#### 1. Conditions for Start Controlling

Judge the controlling start with the indoor heat exchanger temperature after 2 sec. from operation start.

#### 2. Control in Each Zone

The heat exchange intermediate temperature of indoor unit controls the following.

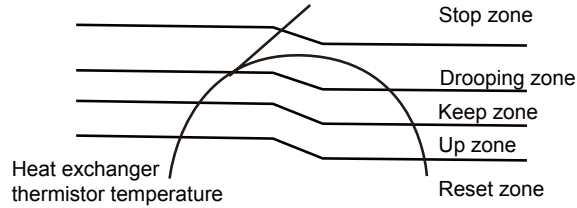

## Defrost Control

### Outline

#### Heat Pump Only

Defrosting is carried out by the cooling cycle (reverse cycle). The defrosting time or outdoor heat exchanger temperature must be more than its fixed value when finishing.

### Detail

#### 1. Conditions for Starting Defrost

The starting conditions must be made with the outdoor air temperature and heat exchanger temperature. Under the conditions that the system is in heating operation, 6 minutes after the compressor is started and more than 44 minutes of accumulated time pass since the start of the operation or ending the defrosting.

#### 2. Conditions for Canceling Defrost

The judgment must be made with heat exchanger temperature. (39°F~72°F)

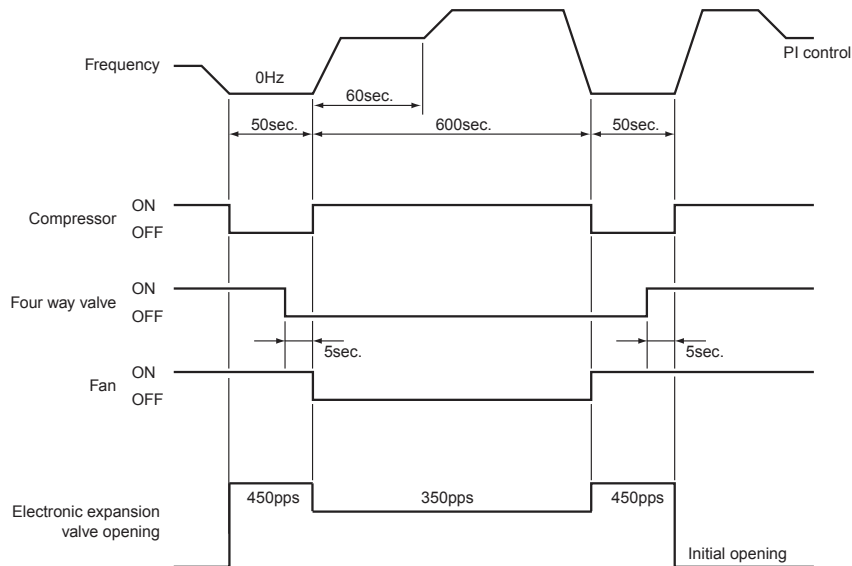

## Fan Control

### Outline

Fan control is carried out according to the following priority.

1. Fan ON control for electric component cooling fan
2. Fan control when defrosting

3. Fan OFF delay when stopped
4. ON/OFF control in cooling operation
5. Tap control when drooping function is working
6. Fan control in forced operation
7. Fan control in indoor/outdoor unit silent operation
8. Fan control in powerful mode
9. Fan control in normal operation

#### Detail

##### Fan OFF Control when Stopped

\* Fan OFF delay for 60 seconds must be made when the compressor is stopped.

##### Tap Control in indoor/outdoor unit silent operation

###### 1. When Cooling Operation

When the outdoor air temperature is lower than 99°F, the fan tap must be set to L.

###### 2. When Heating Operation

When the outdoor air temperature is higher than 39°F, the fan tap must be turned to L (only for heat pump model).

## Refrigerant Recycling Function (applicable when changing installation location or in maintenance)

### (1) Enter refrigerant recycling function

Within 5min after energizing (unit ON or OFF status is ok), continuously press LIGHT button for 3 times within 3s to enter refrigerant recycling mode; Fo is displayed and refrigerant recycling function is started. At this moment, the maintenance people closes liquid valve. After 5min, stick the thimble of maintenance valve with a tool. If there is no refrigerant spraying out, close the gas valve immediately and then turn off the unit to remove the connection pipe.

### (2) Exit refrigerant recycling function

After entering refrigerant recycling mode, when receive any remote control signal or enter refrigerant recycling mode for 25min, the unit will exit refrigerant recycling mode automatically. If the unit is in standby mode before refrigerant recycling, it will be still in standby mode after finishing refrigerant recycling; if the unit is in ON status before refrigerant recycling, it will still run in original operation mode.

## Compulsive Defrosting Function

### (1) Start up compulsory defrosting function

Under ON status, set heating mode with remote controller and adjust the temperature to 16°C(61°F). Press “+, -, +, -, +,-” button successively within 5s and the complete unit will enter into compulsory defrosting status. Meanwhile, defrosting mark H1 will be shown. (Note: If complete unit has malfunction or stops operation due to protection, compulsory defrosting function can be started up after malfunction or protection is resumed.

### (2) Exit compulsory defrosting mode

After compulsory defrosting is started up, the complete unit will exit defrosting operation according to the actual defrosting result, and the complete unit will resume normal heating operation.

# Part II : Installation and Maintenance

## 7. Notes for Installation and Maintenance

### Safety Precautions: Important!

Please read the safety precautions carefully before installation and maintenance.

The following contents are very important for installation and maintenance.

Please follow the instructions below.

- The installation or maintenance must accord with the instructions.
- Comply with all national electrical codes and local electrical codes.
- Pay attention to the warnings and cautions in this manual.
- All installation and maintenance shall be performed by distributor or qualified person.
- All electric work must be performed by a licensed technician according to local regulations and the instructions given in this manual.
- Be caution during installation and maintenance. Prohibit incorrect operation to prevent electric shock, casualty and other accidents.



### Warnings

#### Electrical Safety Precautions:

1. Cut off the power supply of air conditioner before checking and maintenance.
2. The air condition must apply specialized circuit and prohibit share the same circuit with other appliances.
3. The air conditioner should be installed in suitable location and ensure the power plug is touchable.
4. Make sure each wiring terminal is connected firmly during installation and maintenance.
5. Have the unit adequately grounded. The grounding wire can't be used for other purposes.
6. Must apply protective accessories such as protective boards, cable-cross loop and wire clip.
7. The live wire, neutral wire and grounding wire of power supply must be corresponding to the live wire, neutral wire and grounding wire of the air conditioner.
8. The power cord and power connection wires can't be pressed by hard objects.
9. If power cord or connection wire is broken, it must be replaced by a qualified person.

10. If the power cord or connection wire is not long enough, please get the specialized power cord or connection wire from the manufacture or distributor. Prohibit prolong the wire by yourself.
11. For the air conditioner without plug, an air switch must be installed in the circuit. The air switch should be all-pole parting and the contact parting distance should be more than 1/8 inch.
12. Make sure all wires and pipes are connected properly and the valves are opened before energizing.
13. Check if there is electric leakage on the unit body. If yes, please eliminate the electric leakage.
14. Replace the fuse with a new one of the same specification if it is burnt down; don't replace it with a cooper wire or conducting wire.
15. If the unit is to be installed in a humid place, the circuit breaker must be installed.

#### Installation Safety Precautions:

1. Select the installation location according to the requirement of this manual.(See the requirements in installation part)
2. Handle unit transportation with care; the unit should not be carried by only one person if it is more than 44.09lb.
3. When installing the indoor unit and outdoor unit, a sufficient fixing bolt must be installed; make sure the installation support is firm.
4. Ware safety belt if the height of working is above 78 3/4 inch.
5. Use equipped components or appointed components during installation.
6. Make sure no foreign objects are left in the unit after finishing installation.

#### Refrigerant Safety Precautions:

1. Avoid contact between refrigerant and fire as it generates poisonous gas; Prohibit prolong the connection pipe by welding.
2. Apply specified refrigerant only. Never have it mixed with any other refrigerant. Never have air remain in the refrigerant line as it may lead to rupture or other hazards.
3. Make sure no refrigerant gas is leaking out when installation is completed.
4. If there is refrigerant leakage, please take sufficient measure to minimize the density of refrigerant.
5. Never touch the refrigerant piping or compressor without wearing glove to avoid scald or frostbite.

Improper installation may lead to fire hazard, explosion, electric shock or injury.



## Main Tools for Installation and Maintenance

<p>1. Level meter, measuring tape</p> 	<p>2. Screw driver</p> 	<p>3. Impact drill, drill head, electric drill</p> 
<p>4. Electroprobe</p> 	<p>5. Universal meter</p> 	<p>6. Torque wrench, open-end wrench, inner hexagon spanner</p> 
<p>7. Electronic leakage detector</p> 	<p>8. Vacuum pump</p> 	<p>9. Pressure meter</p> 
<p>10. Pipe pliers, pipe cutter</p> 	<p>11. Pipe expander, pipe bender</p> 	<p>12. Soldering appliance, refrigerant container</p> 

# 8. Installation

## 8.1 Installation Dimension Diagram

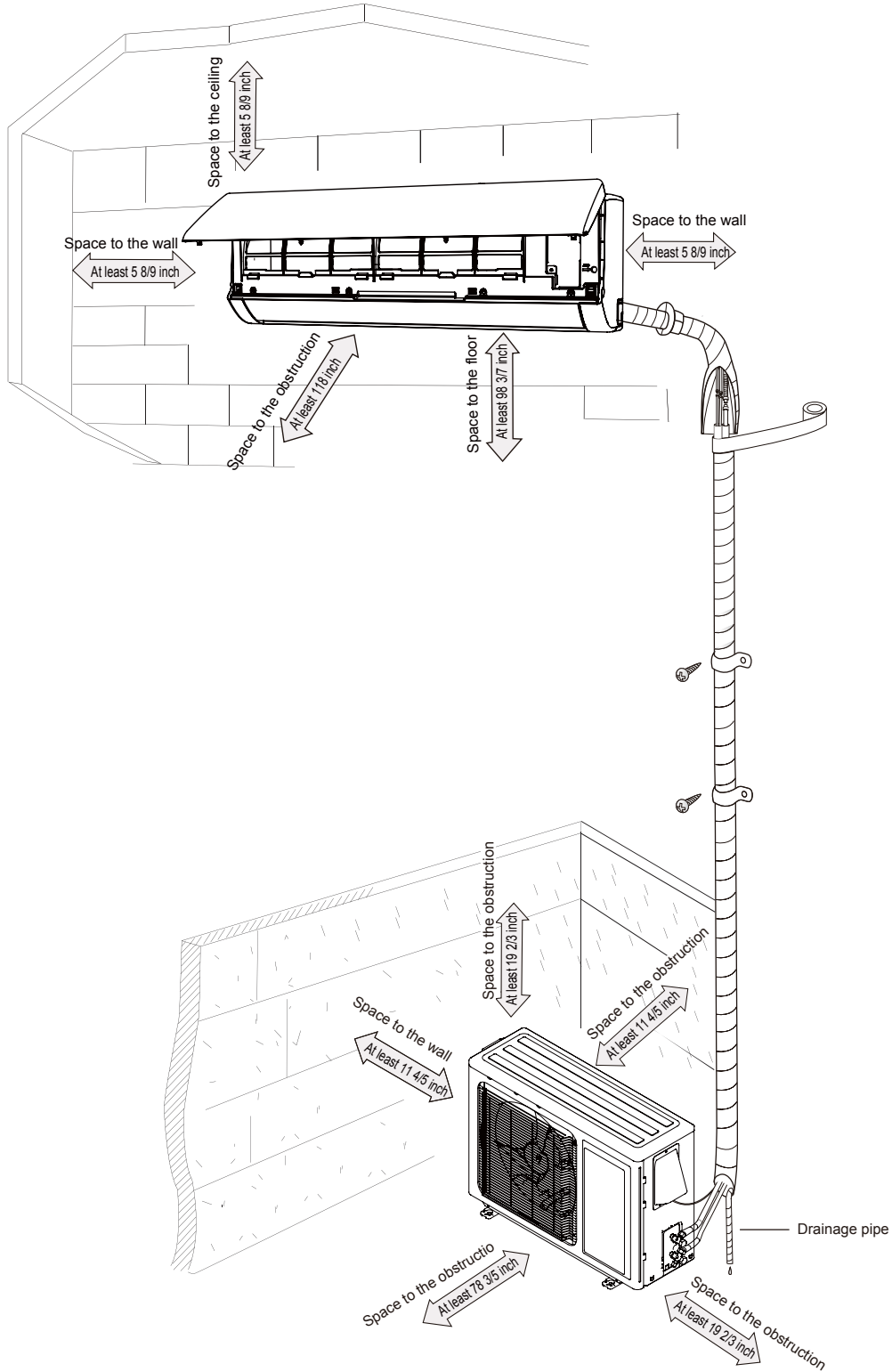

## Installation procedures

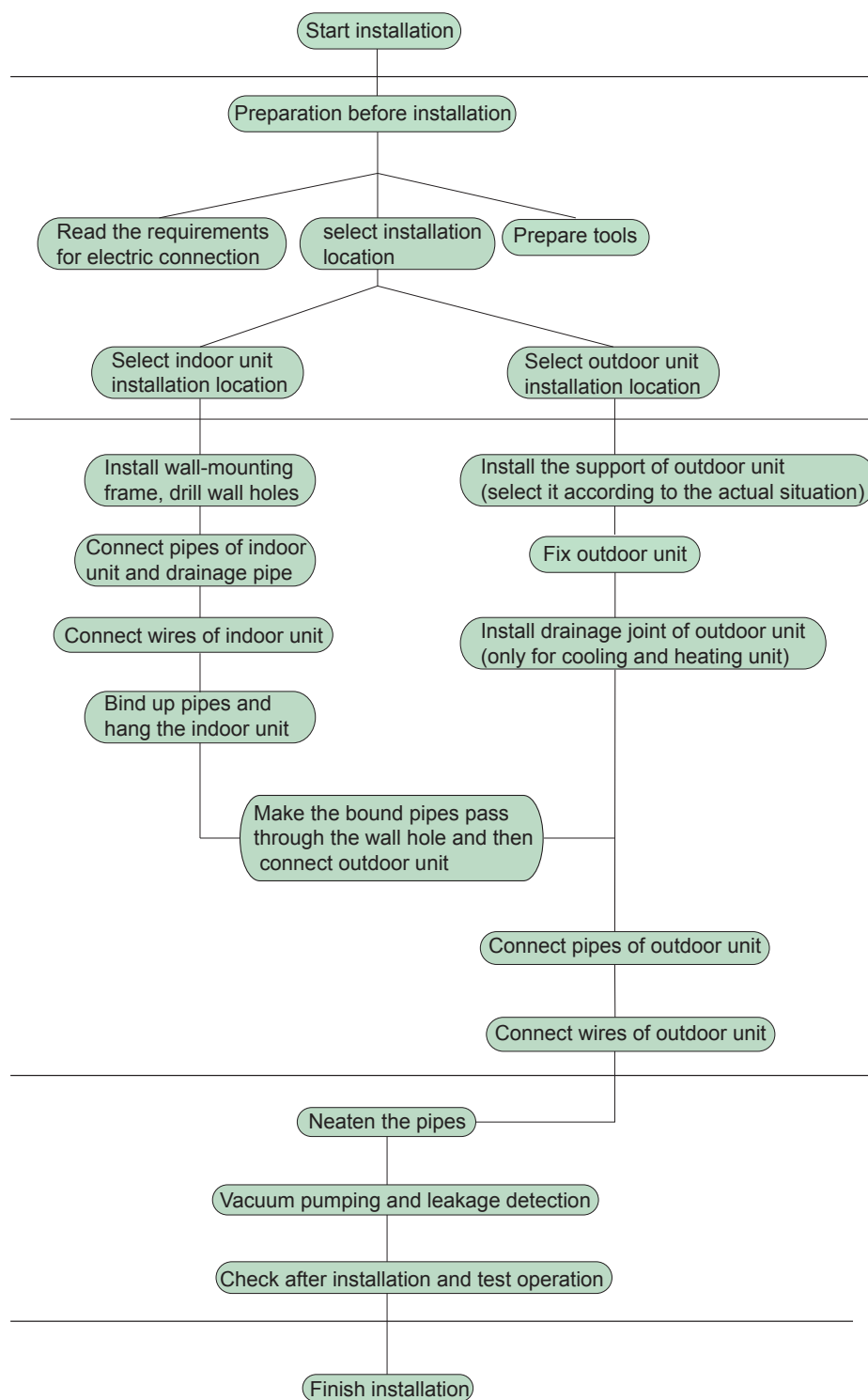

Note: this flow is only for reference; please find the more detailed installation steps in this section.

## 8.2 Installation Parts-checking

No.	Name	No.	Name
1	Indoor unit	8	Sealing gum
2	Outdoor unit	9	Wrapping tape
3	Connection pipe	10	Support of outdoor unit
4	Drainage pipe	11	Fixing screw
5	Wall-mounting frame	12	Drainage plug(cooling and heating unit)
6	Connecting cable(power cord)	13	Owner's manual, remote controller
7	Wall pipe		

**⚠ Note:**

- 1.Please contact the local agent for installation.
- 2.Don't use unqualified power cord.

## 8.3 Selection of Installation Location

### 1. Basic Requirement:

Installing the unit in the following places may cause malfunction. If it is unavoidable, please consult the local dealer:

- (1) The place with strong heat sources, vapors, flammable or explosive gas, or volatile objects spread in the air.
- (2) The place with high-frequency devices (such as welding machine, medical equipment).
- (3) The place near coast area.
- (4) The place with oil or fumes in the air.
- (5) The place with sulfureted gas.
- (6) Other places with special circumstances.

### 2. Indoor Unit:

- (1) There should be no obstruction near air inlet and air outlet.
- (2) Select a location where the condensation water can be dispersed easily and won't affect other people.
- (3) Select a location which is convenient to connect the outdoor unit and near the power socket.
- (4) Select a location which is out of reach for children.
- (5) The location should be able to withstand the weight of indoor unit and won't increase noise and vibration.
- (6) The appliance must be installed 98 3/7inch above floor.
- (7) Don't install the indoor unit right above the electric appliance.
- (8) The appliance shall not be installed in the laundry.

### 3. Outdoor Unit:

- (1) Select a location where the noise and outflow air emitted by the outdoor unit will not affect neighborhood.
- (2) The location should be well ventilated and dry, in which the outdoor unit won't be exposed directly to sunlight or strong wind.
- (3) The location should be able to withstand the weight of outdoor unit.
- (4) Make sure that the installation follows the requirement of installation dimension diagram.
- (5) Select a location which is out of reach for children and far away from animals or plants.If it is unavoidable, please add fence for safety purpose.

## 8.4 Electric Connection Requirement

### 1. Safety Precaution

- (1) Must follow the electric safety regulations when installing the unit.
- (2) According to the local safety regulations, use qualified power supply circuit and air switch.
- (3) Make sure the power supply matches with the requirement of air conditioner. Unstable power supply or incorrect wiring may result in electric shock,fire hazard or malfunction. Please install proper power supply cables before using the air conditioner.
- (4) Properly connect the live wire, neutral wire and grounding wire of power socket.
- (5) Be sure to cut off the power supply before proceeding any work related to electricity and safety.
- (6) Do not put through the power before finishing installation.
- (7) For appliances with type Y attachment,the instructions shall contain the substance of thefollowing.If the supply cord is damaged,it must be replaced by the manufacturer,its service agent or similarly qualified persons in order to avoid a hazard.
- (8) The temperature of refrigerant circuit will be high, please keep the interconnection cable away from the copper tube.

### 2. Grounding Requirement:

- (1) The air conditioner is first class electric appliance. It must be properly grounding with specialized grounding device by a professional. Please make sure it is always grounded effectively, otherwise it may cause electric shock.
- (2) The yellow-green wire in air conditioner is grounding wire, which can't be used for other purposes.
- (3) The grounding resistance should comply with national electric safety regulations.
- (4) The appliance must be positioned so that the plug is accessible.
- (5) An all-pole disconnection switch having a contact separation of at least 3mm in all poles should be connected in fixed wiring.
- (6) Including an air switch with suitable capacity, please note the following table. Air switch should be included magnet buckle and heating buckle function, it can protect the circuit-short and overload. (Caution: please do not use the fuse only for protect the circuit)

## 8.5 Installation of Indoor Unit

### 1. Choosing Installation location

Recommend the installation location to the client and then confirm it with the client.

### 2. Install Wall-mounting Frame

- (1) Hang the wall-mounting frame on the wall; adjust it in horizontal position with the level meter and then point out the screw fixing holes on the wall.
- (2) Drill the screw fixing holes on the wall with impact drill (the specification of drill head should be the same as the plastic expansion particle) and then fill the plastic expansion particles in the holes.

(3) Fix the wall-mounting frame on the wall with tapping screws (ST4.2X25TA) and then check if the frame is firmly installed by pulling the frame. If the plastic expansion particle is loose, please drill another fixing hole nearby.

### 3. Install Wall-mounting Frame

(1) Choose the position of piping hole according to the direction of outlet pipe. The position of piping hole should be a little lower than the wall-mounted frame.(As show in Fig.1)

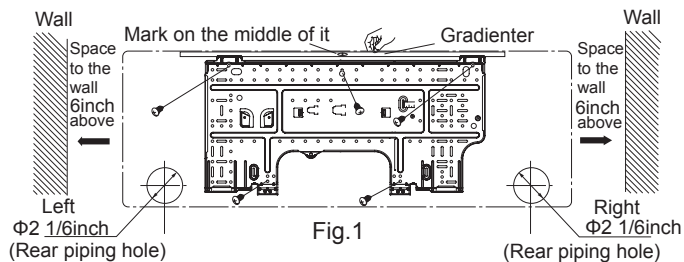

(2) Open a piping hole with the diameter of 2 1/6inch on the selected outlet pipe position. In order to drain smoothly, slant the piping hole on the wall slightly downward to the outdoor side with the gradient of 5-10°. (As show in Fig.2)

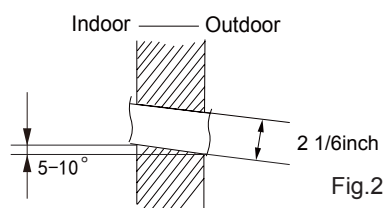

**⚠ Note:**

- (1) Pay attention to dust prevention and take relevant safety measures when opening the hole.
- (2) The plastic expansion particles are not provided and should be bought locally.

### 4. Outlet Pipe

- (1) The pipe can be led out in the direction of right, rear right, left or rear left. (As show in Fig.3)
- (2) When selecting leading out the pipe from left or right, please cut off the corresponding hole on the bottom case. (As show in Fig.4)

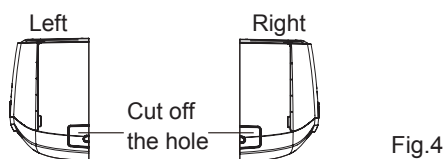
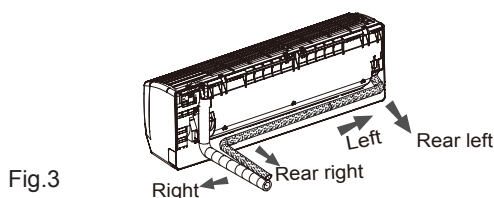

### 5. Connect the Pipe of Indoor Unit

- (1) Aim the pipe joint at the corresponding bellmouth. (As show in Fig.5)
- (2) Pretightening the union nut with hand.
- (3) Adjust the torque force by referring to the following sheet. Place the open-end wrench on the pipe joint and place the torque wrench on the union nut. Tighten the union nut with torque wrench. (As show in Fig.6)
- (4) Wrap the indoor pipe and joint of connection pipe with insulating pipe, and then wrap it with tape. (As show in Fig.7)

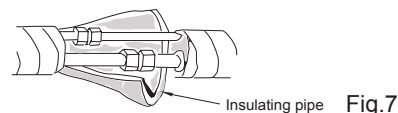
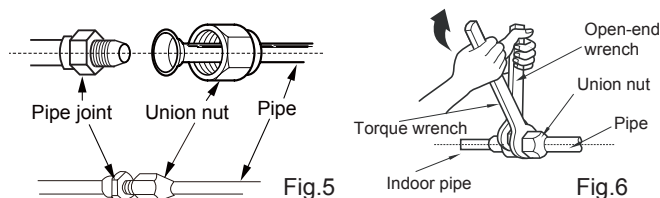

Refer to the following table for wrench moment of force:

Hex nut diameter(inch)	Tightening torque(ft-lbf)
Φ1/4	11~14.7
Φ3/8	22.8~29.5
Φ1/2	33.2~40.6
Φ5/8	44.3~47.9
Φ3/4	51.6~55.3

### 6. Install Drain Hose

- (1) Connect the drain hose to the outlet pipe of indoor unit. (As show in Fig.8)
- (2) Bind the joint with tape. (As show in Fig.9)

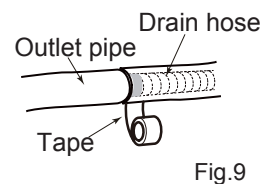
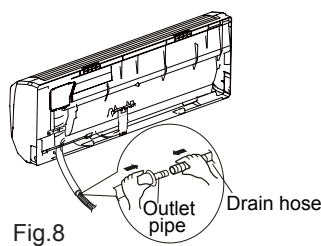

**⚠ Note:**

- (1) Add insulating pipe in the indoor drain hose in order to prevent condensation.
- (2) The plastic expansion particles are not provided. (As show in Fig.10)

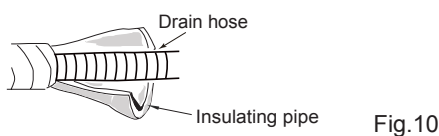

### 7. Connect Wire of Indoor Unit

(1) Open the panel, remove the screw on the wiring cover and then take down the cover.(As show in Fig.11)

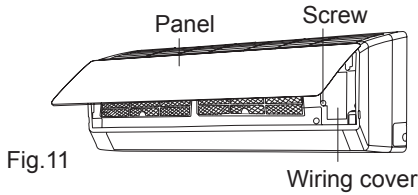

Fig.11

(2) Fix the wire crossing board on connection wire sleeve at the bottom case; let the connection wire sleeve go through the wire crossing hole at the back of indoor unit, and then pull it out from the front.(As show in Fig.12)

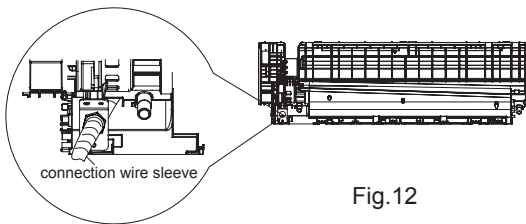

Fig.12

(3) Remove the wire clip; connect the power connection wire to the wiring terminal; tighten the screw and then fix the power connection wire with wire clip.(As show in Fig.13)

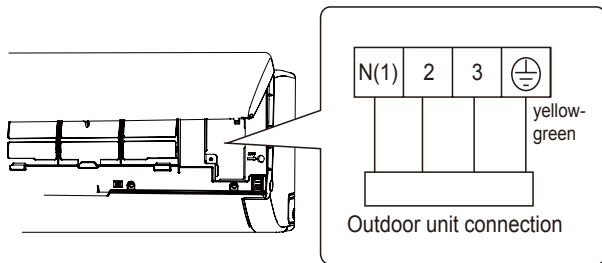

Fig.13

(4) Put wiring cover back and then tighten the screw.  
(5) Close the panel.

**⚠ Note:**

- (1) All wires of indoor unit and outdoor unit should be connected by a professional.
- (2) If the length of power connection wire is insufficient, please contact the supplier for a new one. Avoid extending the wire by yourself.
- (3) For the air conditioner with plug, the plug should be reachable after finishing installation.
- (4) For the air conditioner without plug, an air switch must be installed in the line. The air switch should be all-pole parting and the contact parting distance should be more than 1/8inch.

### 8. Bind up Pipe

- (1) Bind up the connection pipe, power cord and drain hose with the band.(As show in Fig.14)
- (2) Reserve a certain length of drain hose and power cord for installation when binding to a certain degree, separate the indoor power and then separate the drain hose.(As show in Fig.15)
- (3) Bind them evenly.
- (4) The liquid pipe and gas pipe should be bound separately at the end.

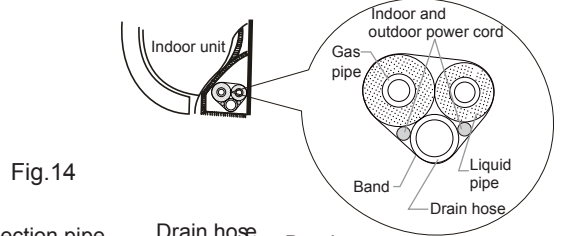

Fig.14

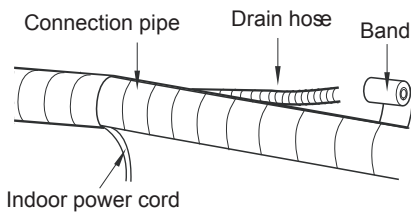

Fig.15

**⚠ Note:**

- (1) The power cord and control wire can't be crossed or winding.
- (2) The drain hose should be bound at the bottom.

### 9. Hang the Indoor Unit

- (1) Put the bound pipes in the wall pipe and then make them pass through the wall hole.
- (2) Hang the indoor unit on the wall-mounting frame.
- (3) Stuff the gap between pipes and wall hole with sealing gum.
- (4) Fix the wall pipe.
- (5) Check if the indoor unit is installed firmly and closed to the wall.(As show in Fig.17)

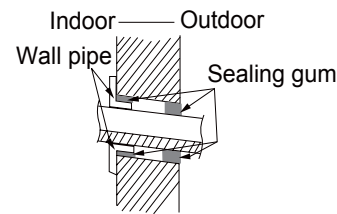

Fig.16

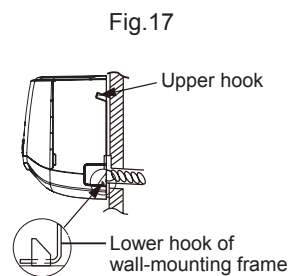

Fig.17

**⚠ Note:**

Do not bend the drain hose too excessively in order to prevent blocking.

## 8.6 Installation of Outdoor Unit

### 1. Fix the Support of Outdoor Unit(Select it according to the actual installation situation)

- (1) Select installation location according to the house structure.
- (2) Fix the support of outdoor unit on the selected location with expansion screws.

**⚠ Note:**

- (1) Take sufficient protective measures when installing the outdoor unit.
- (2) Make sure the support can withstand at least four times the unit weight.
- (3) The outdoor unit should be installed at least 1 1/6inch above the floor in order to install drain joint.(As show in Fig.18)
- (4) For the unit with cooling capacity of 2300W~5000W, 6 expansion screws are needed; for the unit with cooling capacity of 6000W~8000W, 8 expansion screws are needed; for the unit with cooling capacity of 10000W~16000W, 10 expansion screws are needed.

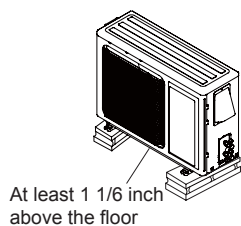

Fig.18

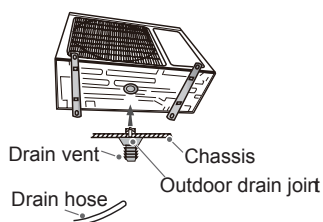

Fig.19

**2. Install Drain Joint(Only for cooling and heating unit)**

- (1) Connect the outdoor drain joint into the hole on the chassis.
  - (2) Connect the drain hose into the drain vent.
- (As show in Fig.19)

**3. Fix Outdoor Unit**

- (1) Place the outdoor unit on the support.
  - (2) Fix the foot holes of outdoor unit with bolts.
- (As show in Fig.20)

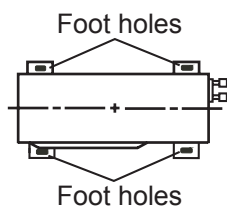

Fig.20

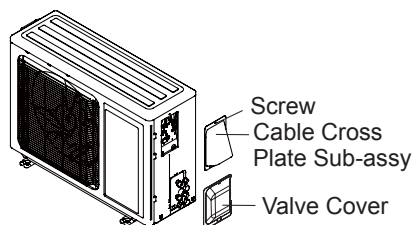

Fig.21

**4. Connect Indoor and Outdoor Pipes**

- (1) Remove the screw on the right cable cross plate sub-assy and valve cover of outdoor unit and then remove the cable cross plate sub-assy and valve cover.(As show in Fig.21)
- (2) Remove the screw cap of valve and aim the pipe joint at the bellmouth of pipe.(As show in Fig.22)

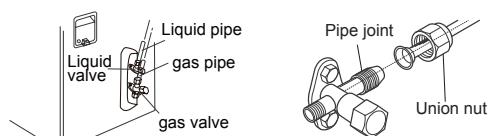

Fig.22

- (3) Pretightening the union nut with hand.
- (4) Tighten the union nut with torque wrench .

Refer to the following table for wrench moment of force:

Hex nut diameter(inch)	Tightening torque(ft-lbf)
Φ1/4	11~14.7
Φ3/8	22.8~29.5
Φ1/2	33.2~40.6
Φ5/8	44.3~47.9
Φ3/4	51.6~55.3

**5. Connect Outdoor Electric Wire**

- (1) Put power connection wire and power wire through the wire-passing hole.
- (2) Remove the wire clip; connect the power connection wire and power wire to the wiring terminal; fix them with screws.(As show in Fig.23)
- (3) Fix the power connection wire and power wire with wire clip.
- (4) Install the cable cross plate sub-assy.

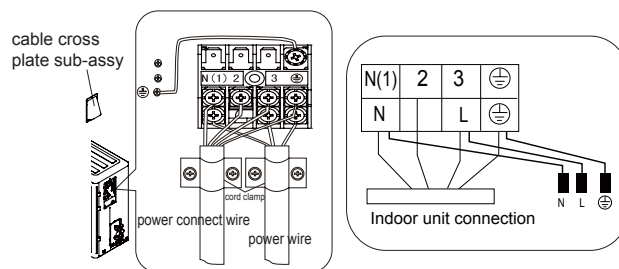
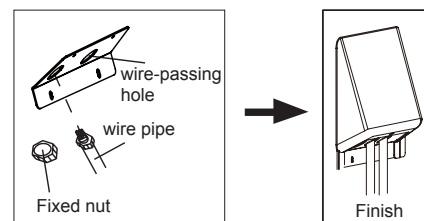

Fig.23

**⚠ Note:**

- (1) After tightening the screw, pull the power cord slightly to check if it is firm.
- (2) Never cut the power connection wire to prolong or shorten the distance.
- (3) The connecting wire and connection pipe cannot touch each other.
- (4) Top cover of outdoor unit and electric box assembly should be fixed by the screw. Otherwise, it can cause a fire, or short circuit caused by water or dust.

**Install the over line pipe**



**6. Neaten the Pipes**

- (1) The pipes should be placed along the wall, bent reasonably and hidden possibly. Min. semidiameter of bending the pipe is 4inch.
- (2) If the outdoor unit is higher than the wall hole, you must set a U-shaped curve in the pipe before pipe goes into the room, in order to prevent rain from getting into the room.(As show in Fig.24)

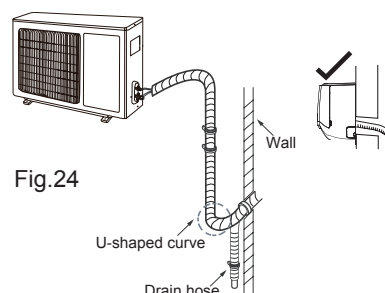

Fig.24



Fig.25

**⚠ Note:**

- (1) The through-wall height of drain hose shouldn't be higher than the outlet pipe hole of indoor unit.(As show in Fig.25)
- (2) Slant the drain hose slightly downwards. The drain hose can't be curved, raised and fluctuant, etc.(As show in Fig.26)
- (3) The water outlet can't be placed in water in order to drain smoothly.(As show in Fig.27)

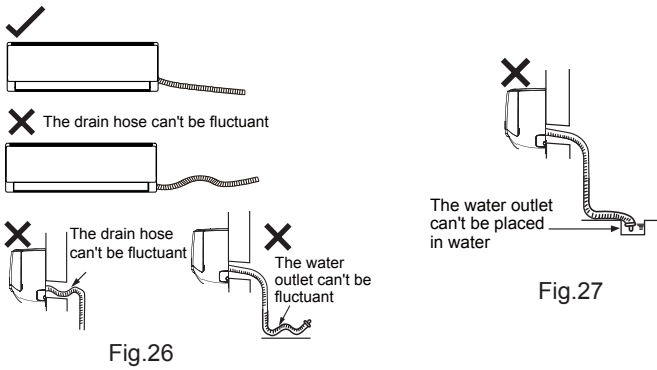

## 8.7 Vacuum Pumping and Leak Detection

### 1. Use Vacuum Pump

- (1) Remove the valve caps on the liquid valve and gas valve and the nut of refrigerant charging vent.
- (2) Connect the charging hose of piezometer to the refrigerant charging vent of gas valve and then connect the other charging hose to the vacuum pump.
- (3) Open the piezometer completely and operate for 10-15min to check if the pressure of piezometer remains in -0.1MPa.
- (4) Close the vacuum pump and maintain this status for 1-2min to check if the pressure of piezometer remains in -0.1MPa. If the pressure decreases, there may be leakage.
- (5) Remove the piezometer, open the valve core of liquid valve and gas valve completely with inner hexagon spanner.
- (6) Tighten the screw caps of valves and refrigerant charging vent.(As show in Fig.28)

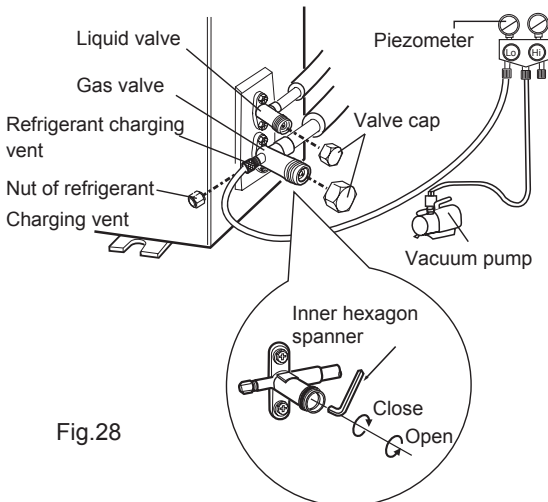

### 2. Leakage Detection

- (1) With leakage detector:  
Check if there is leakage with leakage detector.
- (2) With soap water:  
If leakage detector is not available, please use soap water for leakage detection. Apply soap water at the suspected position and keep the soap water for more than 3min. If there are air bubbles coming out of this position, there's a leakage.

## 8.8 Check after Installation and Test Operation

### 1. Check after Installation

Check according to the following requirement after finishing installation.

No.	Items to be checked	Possible malfunction
1	Has the unit been installed firmly?	The unit may drop, shake or emit noise.
2	Have you done the refrigerant leakage test?	It may cause insufficient cooling (heating) capacity.
3	Is heat insulation of pipeline sufficient?	It may cause condensation and water dripping.
4	Is water drained well?	It may cause condensation and water dripping.
5	Is the voltage of power supply according to the voltage marked on the nameplate?	It may cause malfunction or damage the parts.
6	Is electric wiring and pipeline installed correctly?	It may cause malfunction or damage the parts.
7	Is the unit grounded securely?	It may cause electric leakage.
8	Does the power cord follow the specification?	It may cause malfunction or damage the parts.
9	Is there any obstruction in air inlet and air outlet?	It may cause insufficient cooling (heating).
10	The dust and sundries caused during installation are removed?	It may cause malfunction or damaging the parts.
11	The gas valve and liquid valve of connection pipe are open completely?	It may cause insufficient cooling (heating) capacity.

### 2. Test Operation

- (1) Preparation of test operation
  - The client approves the air conditioner installation.
  - Specify the important notes for air conditioner to the client.
- (2) Method of test operation
  - Put through the power, press ON/OFF button on the remote controller to start operation.
  - Press MODE button to select AUTO, COOL, DRY, FAN and HEAT to check whether the operation is normal or not.
  - If the ambient temperature is lower than 60.8°F, the air conditioner can't start cooling.



## 9. Maintenance

### 9.1 Error Code List

#### 1. Malfunction display requirement

When there are several malfunctions, they will be displayed circularly.

#### 2. Malfunction display method

(1) Hardware malfunction: immediate display; refer to "error code list";

(2) Operation state: immediate display; refer to "error code list";

(3) Other malfunctions: it is displayed after the compressor stops for 200s; refer to "error code list".

**Note: when the compressor is restarted, the malfunction display delay time (200s) is cleared.**

#### 3. Display control viaremote controller

Enter display control: press light button successively for 4 times within 3s to display the corresponding malfunction code;

Exit display control: pressing light button successively for 4 times within 3s or after display is shown for 5min, the display will terminate.

No.	Malfunction Name	Display Method of Indoor Unit			Display Method of Outdoor Unit			A/C status	Possible Causes	
		Dual-8 Code Display	Indicator Display (during blinking, ON 0.5s and OFF 0.5s)			Indicator has 3 kinds of display status and during blinking, ON 0.5s and OFF 0.5s				
			Power Indicator	Cool Indicator	Heating Indicator	Yellow Indicator	Red Indicator			Green Indicator
1	High pressure protection of system	E1	OFF 3s and blink once						During cooling and drying operation, except indoor fan operates, all loads stop operation. During heating operation, the complete unit stops.	Possible reasons: 1. Refrigerant was superabundant; 2. Poor heat exchange (including filth blockage of heat exchanger and bad radiating environment ); Ambient temperature is too high.
2	Antifreezing protection	E2	OFF 3S and blink twice				OFF 1S and blink 3 times		During cooling and drying operation, compressor and outdoor fan stop while indoor fan operates.	1. Poor air-return in indoor unit; 2. Fan speed is abnormal; 3. Evaporator is dirty.
3	In defect of refrigerant	F0						OFF 1S and blink 9 times	The Dual-8 Code Display will show F0 and the complete unit stops.	1.In defect of refrigerant; 2.Indoor evaporator temperature sensor works abnormally; 3.The unit has been plugged up somewhere.
4	High discharge temperature protection of compressor	E4	OFF 3S and blink 4 times				OFF 1S and blink 7 times		During cooling and drying operation, compressor and outdoor fan stop while indoor fan operates. During heating operation, all loads stop.	Please refer to the malfunction analysis (discharge protection, overload).
5	Overcurrent protection	E5	OFF 3S and blink 5 times				OFF 1S and blink 5 times		During cooling and drying operation, compressor and outdoor fan stop while indoor fan operates. During heating operation, all loads stop.	1. Supply voltage is unstable; 2. Supply voltage is too low and load is too high; 3. Evaporator is dirty.
6	Communication Malfunction	E6	OFF 3S and blink 6 times				Always ON		During cooling operation, compressor stops while indoor fan motor operates. During heating operation, the complete unit stops.	Refer to the corresponding malfunction analysis.
7	High temperature resistant protection	E8	OFF 3S and blink 8 times				OFF 1S and blink 6 times		During cooling operation: compressor will stop while indoor fan will operate. During heating operation, the complete unit stops.	Refer to the malfunction analysis (overload, high temperature resistant).
8	EEPROM malfunction	EE			OFF 3S and blink 15 times		OFF 1S and blink 11 times		During cooling and drying operation, compressor will stop while indoor fan will operate; During heating operation, the complete unit will stop	Replace outdoor control panel AP1
9	Limit/ decrease frequency due to high temperature of module	EU		OFF 3S and blink 6 times	OFF 3S and blink 6 times				All loads operate normally, while operation frequency for compressor is decreased	Discharging after the complete unit is de-energized for 20mins, check whether the thermal grease on IPM Module of outdoor control panel AP1 is sufficient and whether the radiator is inserted tightly. If its no use, please replace control panel AP1.
10	Malfunction protection of jumper cap	C5	OFF 3S and blink 15 times						Wireless remote receiver and button are effective, but can not dispose the related command	1. No jumper cap insert on mainboard. 2. Incorrect insert of jumper cap. 3. Jumper cap damaged. 4. Abnormal detecting circuit of mainboard.

No.	Malfunction Name	Display Method of Indoor Unit			Display Method of Outdoor Unit			A/C status	Possible Causes	
		Dual-8 Code Display	Indicator Display (during blinking, ON 0.5s and OFF 0.5s)			Indicator has 3 kinds of display status and during blinking, ON 0.5s and OFF 0.5s				
			Power Indicator	Cool Indicator	Heating Indicator	Yellow Indicator	Red Indicator			Green Indicator
11	Gathering refrigerant	Fo	OFF 3S and blink 1 times	OFF 3S and blink 1 times		OFF 1S and blink 17 times			When the outdoor unit receive signal of Gathering refrigerant ,the system will be forced to run under cooling mode for gathering refrigerant	Nominal cooling mode
12	Indoor ambient temperature sensor is open/short circuited	F1		OFF 3S and blink once					During cooling and drying operation, indoor unit operates while other loads will stop; during heating operation, the complete unit will stop operation.	1. Loosening or bad contact of indoor ambient temp. sensor and mainboard terminal. 2. Components in mainboard fell down leads short circuit. 3. Indoor ambient temp. sensor damaged.(check with sensor resistance value chart) 4. Mainboard damaged.
13	Indoor evaporator temperature sensor is open/short circuited	F2		OFF 3S and blink twice					AC stops operation once reaches the setting temperature. Cooling, drying: internal fan motor stops operation while other loads stop operation; heating: AC stop operation	1. Loosening or bad contact of Indoor evaporator temp. sensor and mainboard terminal. 2. Components on the mainboard fall down leads short circuit. 3. Indoor evaporator temp. sensor damaged.(check temp. sensor value chart for testing) 4. Mainboard damaged.
14	Outdoor ambient temperature sensor is open/short circuited	F3		OFF 3S and blink 3 times			OFF 1S and blink 6 times		During cooling and drying operating, compressor stops while indoor fan operates; During heating operation, the complete unit will stop operation	Outdoor temperature sensor hasnt been connected well or is damaged. Please check it by referring to the resistance table for temperature sensor)
15	Outdoor condenser temperature sensor is open/short circuited	F4		OFF 3S and blink 4 times			OFF 1S and blink 5 times		During cooling and drying operation, compressor stops while indoor fan will operate; During heating operation, the complete unit will stop operation.	Outdoor temperature sensor hasnt been connected well or is damaged. Please check it by referring to the resistance table for temperature sensor)
16	Outdoor discharge temperature sensor is open/short circuited	F5		OFF 3S and blink 5 times			OFF 1S and blink 7 times		During cooling and drying operation, compressor will sop after operating for about 3 mins, while indoor fan will operate; During heating operation, the complete unit will stop after operating for about 3 mins.	1.Outdoor temperature sensor hasnt been connected well or is damaged. Please check it by referring to the resistance table for temperature sensor) 2.The head of temperature sensor hasnt been inserted into the copper tube
17	Limit/ decrease frequency due to overload	F6		OFF 3S and blink for 6 times			OFF 1S and blink 3 times		All loads operate normally, while operation frequency for compressor is decreased	Refer to the malfunction analysis (overload, high temperature resistant)
18	Decrease frequency due to overcurrent	F8		OFF 3S and blink 8 times			OFF 1S and blink once		All loads operate normally, while operation frequency for compressor is decreased	The input supply voltage is too low; System pressure is too high and overload

No.	Malfunction Name	Display Method of Indoor Unit			Display Method of Outdoor Unit			A/C status	Possible Causes	
		Dual-8 Code Display	Indicator Display (during blinking, ON 0.5s and OFF 0.5s)			Indicator has 3 kinds of display status and during blinking, ON 0.5s and OFF 0.5s				
			Power Indicator	Cool Indicator	Heating Indicator	Yellow Indicator	Red Indicator			Green Indicator
19	Decrease frequency due to high air discharge	F9		OFF 3S and blink 9 times				OFF 1S and blink twice	All loads operate normally, while operation frequency for compressor is decreased	Overload or temperature is too high; Refrigerant is insufficient; Malfunction of electric expansion valve (EKV)
20	Limit/ decrease frequency due to antifreezing	FH		OFF 3S and blink 2 times	OFF 3S and blink 2 times			OFF 1S and blink 4 times	All loads operate normally, while operation frequency for compressor is decreased	Poor air-return in indoor unit or fan speed is too low
21	Voltage for DC bus-bar is too high	PH		OFF 3S and blink 11 times				OFF 1S and blink 13 times	During cooling and drying operation, compressor will stop while indoor fan will operate; During heating operation, the complete unit will stop operation.	1. Measure the voltage of position L and N on wiring board (XT), if the voltage is higher than 265VAC, turn on the unit after the supply voltage is increased to the normal range. 2.If the AC input is normal, measure the voltage of electrolytic capacitor C on control panel (AP1), if its normal, theres malfunction for the circuit, please replace the control panel (AP1)
22	Voltage of DC bus-bar is too low	PL			OFF 3S and blink 21 times			OFF 1S and blink 12 times	During cooling and drying operation, compressor will stop while indoor fan will operate; During heating operation, the complete unit will stop	1. Measure the voltage of position L and N on wiring board (XT), if the voltage is higher than 150VAC, turn on the unit after the supply voltage is increased to the normal range. 2.If the AC input is normal, measure the voltage of electrolytic capacitor C on control panel (AP1), if its normal, theres malfunction for the circuit, please replace the control panel (AP1)
23	Compressor Min frequency in test state	P0		(during blinking, ON 0.25s and OFF 0.25s)	(during blinking, ON 0.25s and OFF 0.25s)					Showing during min. cooling or min. heating test
24	Compressor rated frequency in test state	P1		(during blinking, ON 0.25s and OFF 0.25s)	(during blinking, ON 0.25s and OFF 0.25s)					Showing during nominal cooling or nominal heating test
25	Compressor maximum frequency in test state	P2		(during blinking, ON 0.25s and OFF 0.25s)	(during blinking, ON 0.25s and OFF 0.25s)					Showing during max. cooling or max. heating test

No.	Malfunction Name	Display Method of Indoor Unit			Display Method of Outdoor Unit			A/C status	Possible Causes	
		Dual-8 Code Display	Indicator Display (during blinking, ON 0.5s and OFF 0.5s)			Indicator has 3 kinds of display status and during blinking, ON 0.5s and OFF 0.5s				
			Power Indicator	Cool Indicator	Heating Indicator	Yellow Indicator	Red Indicator	Green Indicator		
26	Compressor intermediate frequency in test state	P3		(during blinking, ON 0.25s and OFF 0.25s)	(during blinking, ON 0.25s and OFF 0.25s)					Showing during middle cooling or middle heating test
27	Overcurrent protection of phase current for compressor	P5		OFF 3S and blink 15 times					During cooling and drying operation, compressor will stop while indoor fan will operate; During heating operation, the complete unit will stop operation.	Refer to the malfunction analysis (IPM protection, loss of synchronism protection and overcurrent protection of phase current for compressor).
28	Charging malfunction of capacitor	PU			OFF 3S and blink 17 times				During cooling and drying operation, compressor will stop while indoor fan will operate; During heating operation, the complete unit will stop	Refer to the part three—charging malfunction analysis of capacitor
29	Malfunction of module temperature sensor circuit	P7			OFF 3S and blink 18 times				During cooling and drying operation, compressor will stop while indoor fan will operate; During heating operation, the complete unit will stop	Replace outdoor control panel AP1
30	Module high temperature protection	P8			OFF 3S and blink 19 times				During cooling operation, compressor will stop while indoor fan will operate; During heating operation, the complete unit will stop	After the complete unit is de-energized for 20mins, check whether the thermal grease on IPM Module of outdoor control panel AP1 is sufficient and whether the radiator is inserted tightly. If its no use, please replace control panel AP1.
31	Decrease frequency due to high temperature resistant during heating operation	H0			OFF 3S and blink 10 times				All loads operate normally, while operation frequency for compressor is decreased	Refer to the malfunction analysis (overload, high temperature resistant)
32	Static dedusting protection	H2			OFF 3S and blink twice					
33	Overload protection for compressor	H3			OFF 3S and blink 3 times	OFF 1S and blink 8 times			During cooling and drying operation, compressor will stop while indoor fan will operate; During heating operation, the complete unit will stop operation.	1. Wiring terminal OVC-COMP is loosened. In normal state, the resistance for this terminal should be less than 1ohm. 2.Refer to the malfunction analysis ( discharge protection, overload)

No.	Malfunction Name	Display Method of Indoor Unit			Display Method of Outdoor Unit			A/C status	Possible Causes	
		Dual-8 Code Display	Indicator Display (during blinking, ON 0.5s and OFF 0.5s)			Indicator has 3 kinds of display status and during blinking, ON 0.5s and OFF 0.5s				
			Power Indicator	Cool Indicator	Heating Indicator	Yellow Indicator	Red Indicator			Green Indicator
34	System is abnormal	H4			OFF 3S and blink 4 times	OFF 1S and blink 6 times			During cooling and drying operation, compressor will stop while indoor fan will operate; During heating operation, the complete unit will stop operation.	Refer to the malfunction analysis (overload, high temperature resistant)
35	IPM protection	H5			OFF 3S and blink 5 times	OFF 1S and blink 4 times			During cooling and drying operation, compressor will stop while indoor fan will operate; During heating operation, the complete unit will stop operation.	Refer to the malfunction analysis (IPM protection, loss of synchronism protection and overcurrent protection of phase current for compressor.
36	Module temperature is too high	H5			OFF 3S and blink 5 times	OFF 1S and blink 10 times				
37	Internal motor (fan motor) do not operate	H6	OFF 3S and blink 11 times						Internal fan motor, external fan motor, compressor and electric heater stop operation,guide louver stops at present location.	1. Bad contact of DC motor feedback terminal. 2. Bad contact of DC motor control end. 3. Fan motor is stalling. 4. Motor malfunction. 5. Malfunction of mainboard rev detecting circuit.
38	Desynchronizing of compressor	H7			OFF 3S and blink 7 times				During cooling and drying operation, compressor will stop while indoor fan will operate; During heating operation, the complete unit will stop operation.	Refer to the malfunction analysis (IPM protection, loss of synchronism protection and overcurrent protection of phase current for compressor.
39	PFC protection	HC			OFF 3S and blink 6 times	OFF 1S and blink 14 times			During cooling and drying operation, compressor will stop while indoor fan will operate; During heating operation, the complete unit will stop operation.	Refer to the malfunction analysis
40	Outdoor DC fan motor malfunction	L3	OFF 3S and blink 23 times				OFF 1S and blink 14 times		Outdoor DC fan motor malfunction lead to compressor stop operation,	DC fan motor malfunction or system blocked or the connector loosed
41	power protection	L9	OFF 3S and blink 20 times			OFF 1S and blink 9 times			compressor stop operation and Outdoor fan motor will stop 30s latter , 3 minutes latter fan motor and compressor will restart	To protect the electrical components when detect high power
42	Indoor unit and outdoor unit doesn't match	LP	OFF 3S and blink 19 times			OFF 1S and blink 16 times			compressor and Outdoor fan motor can't work	Indoor unit and outdoor unit doesn't match
43	Failure start-up	LC			OFF 3S and blink 11 times				During cooling and drying operation, compressor will stop while indoor fan will operate; During heating operation, the complete unit will stop operation.	Refer to the malfunction analysis

No.	Malfunction Name	Display Method of Indoor Unit			Display Method of Outdoor Unit			A/C status	Possible Causes	
		Dual-8 Code Display	Indicator Display (during blinking, ON 0.5s and OFF 0.5s)			Indicator has 3 kinds of display status and during blinking, ON 0.5s and OFF 0.5s				
			Power Indicator	Cool Indicator	Heating Indicator	Yellow Indicator	Red Indicator			Green Indicator
44	Malfunction of phase current detection circuit for compressor	U1			OFF 3S and blink 13 times				During cooling and drying operation, compressor will stop while indoor fan will operate; During heating operation, the complete unit will stop	Replace outdoor control panel AP1
45	Malfunction of voltage dropping for DC bus-bar	U3			OFF 3S and blink 20 times				During cooling and drying operation, compressor will stop while indoor fan will operate; During heating operation, the complete unit will stop	Supply voltage is unstable
46	Malfunction of complete units current detection	U5		OFF 3S and blink 13 times					During cooling and drying operation, the compressor will stop while indoor fan will operate; During heating operating, the complete unit will stop operation.	Theres circuit malfunction on outdoor units control panel AP1, please replace the outdoor units control panel AP1.
47	The four-way valve is abnormal	U7		OFF 3S and blink 20 times					If this malfunction occurs during heating operation, the complete unit will stop operation.	1. Supply voltage is lower than AC175V; 2. Wiring terminal 4V is loosened or broken; 3. 4V is damaged, please replace 4V.
48	Zero-crossing malfunction of outdoor unit	U9	OFF 3S and blink 18 times						During cooling operation, compressor will stop while indoor fan will operate; during heating, the complete unit will stop operation.	Replace outdoor control panel AP1
49	Frequency limiting (power)						OFF 1S and blink 13 times			
50	Compressor running					OFF 1S and blink once				
51	The temperature for turning on the unit is reached						OFF 1S and blink 8 times			
52	Frequency limiting (module temperature)						OFF 1S and blink 11 times			

No.	Malfunction Name	Display Method of Indoor Unit			Display Method of Outdoor Unit			A/C status	Possible Causes
		Dual-8 Code Display	Indicator Display (during blinking, ON 0.5s and OFF 0.5s)			Indicator has 3 kinds of display status and during blinking, ON 0.5s and OFF 0.5s			
			Power Indicator	Cool Indicator	Heating Indicator	Yellow Indicator	Red Indicator	Green Indicator	
53	Normal communication							OFF 0.5S and blink once	
54	Defrosting	H1			OFF 3S and blink once	OFF 1S and blink twice			Defrosting will occur in heating mode. Compressor will operate while indoor fan will stop operation.



## 9.2 Troubleshooting for Main Malfunction

### 1. Malfunction of Temperature Sensor F1, F2

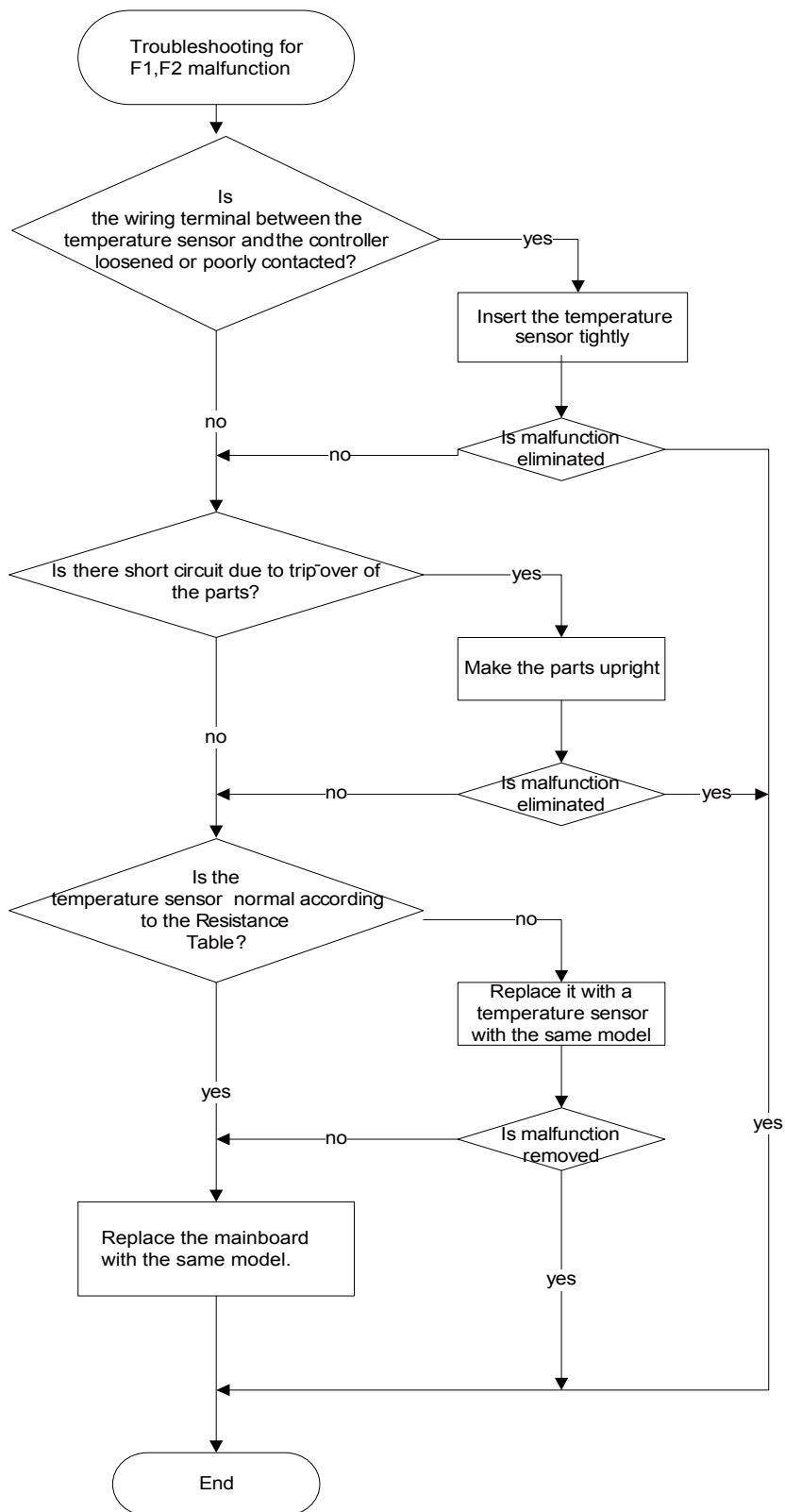

2. Malfunction of Blocked Protection of IDU Fan Motor H6

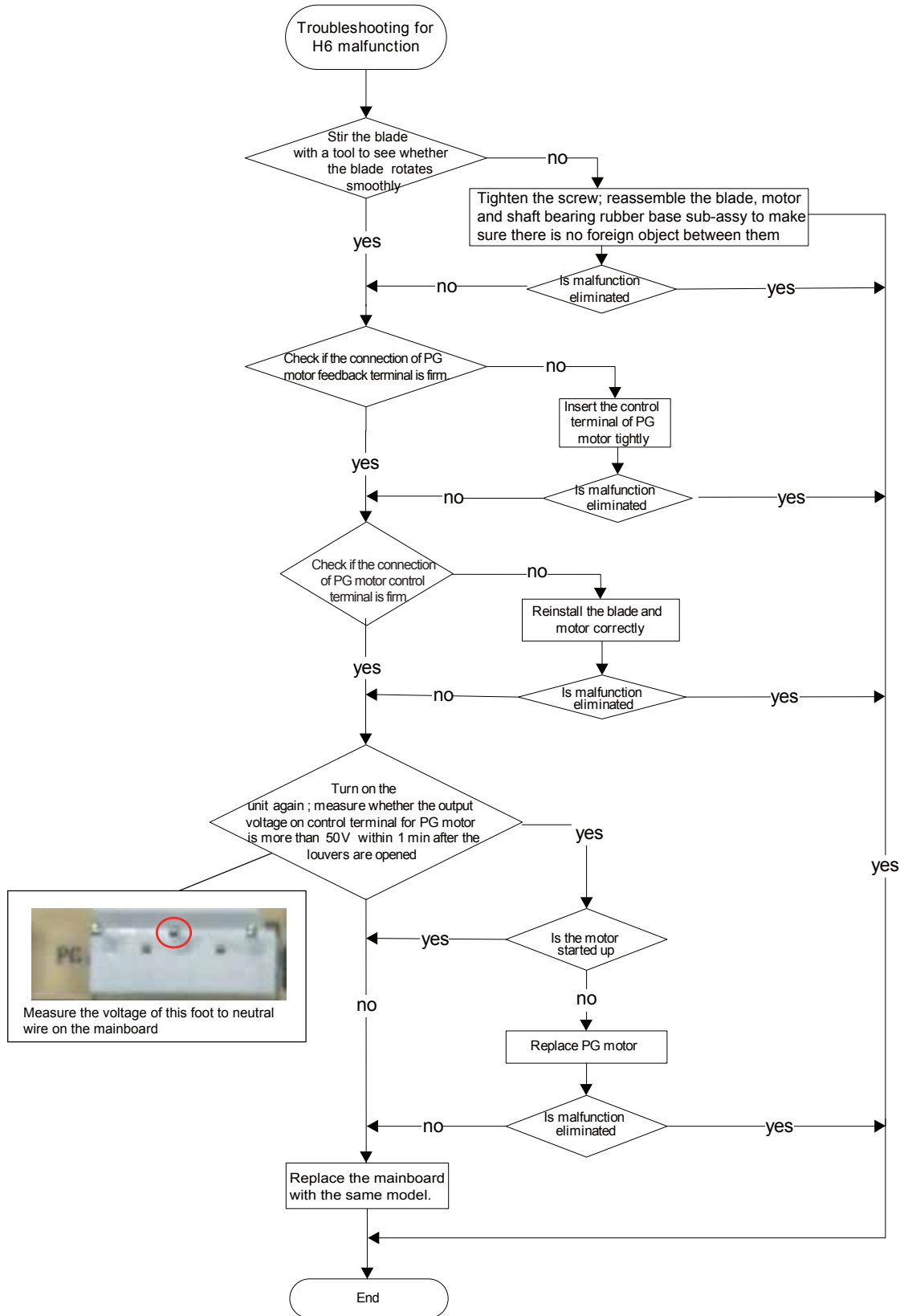

### 3. Malfunction of Protection of Jumper Cap C5

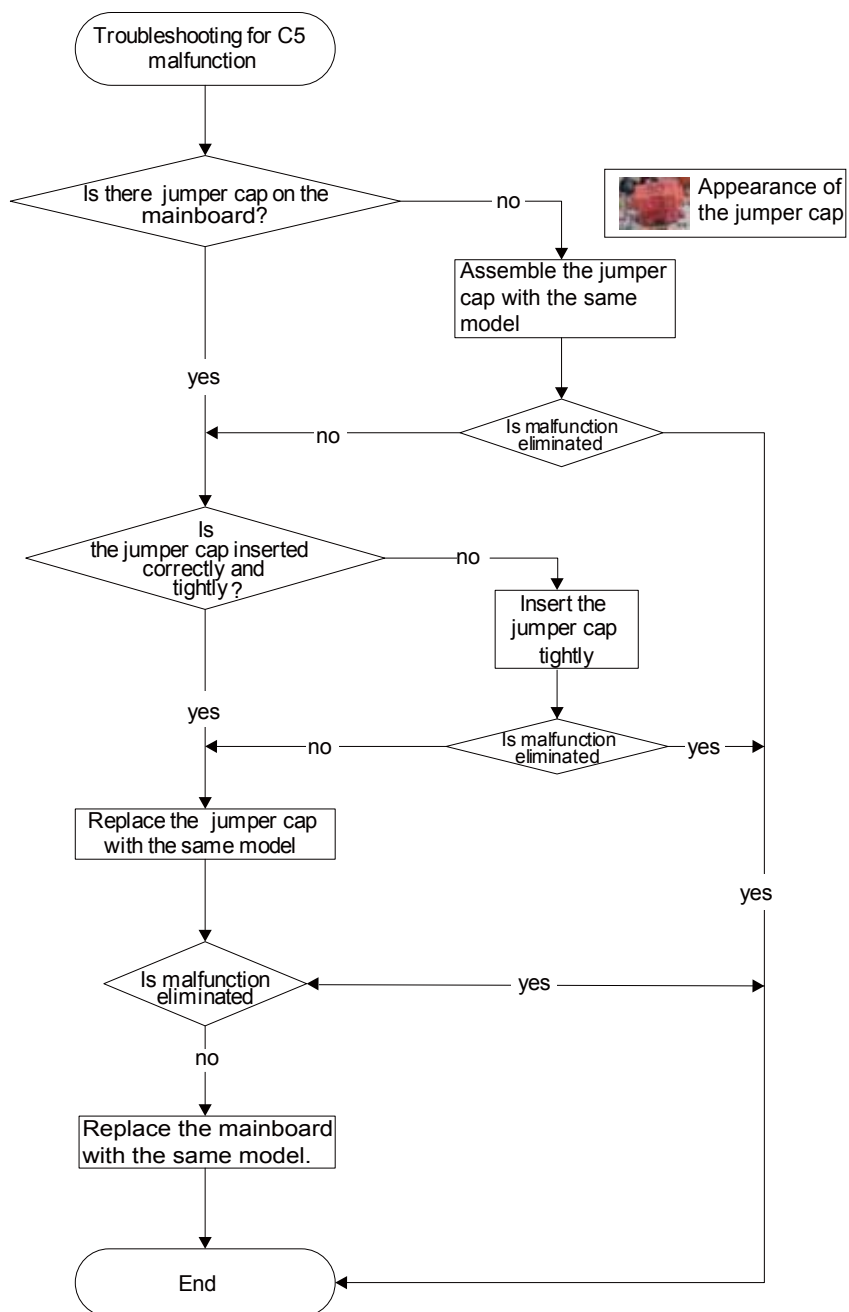

4. Malfunction of Zero-crossing Inspection Circuit Malfunction of the IDU Fan Motor U8

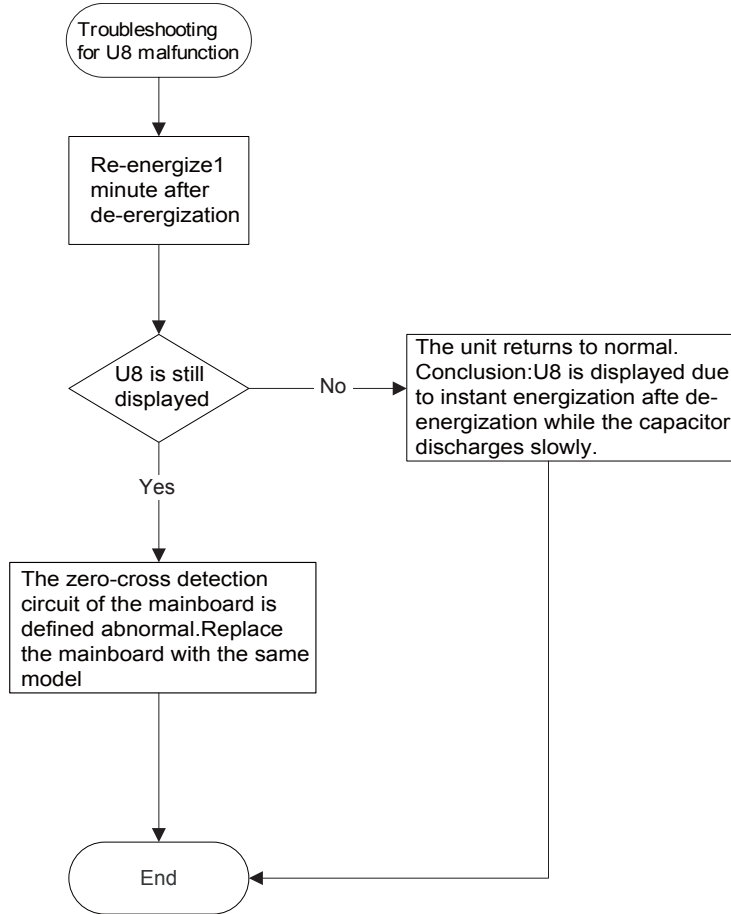

5. Malfunction of communication E6

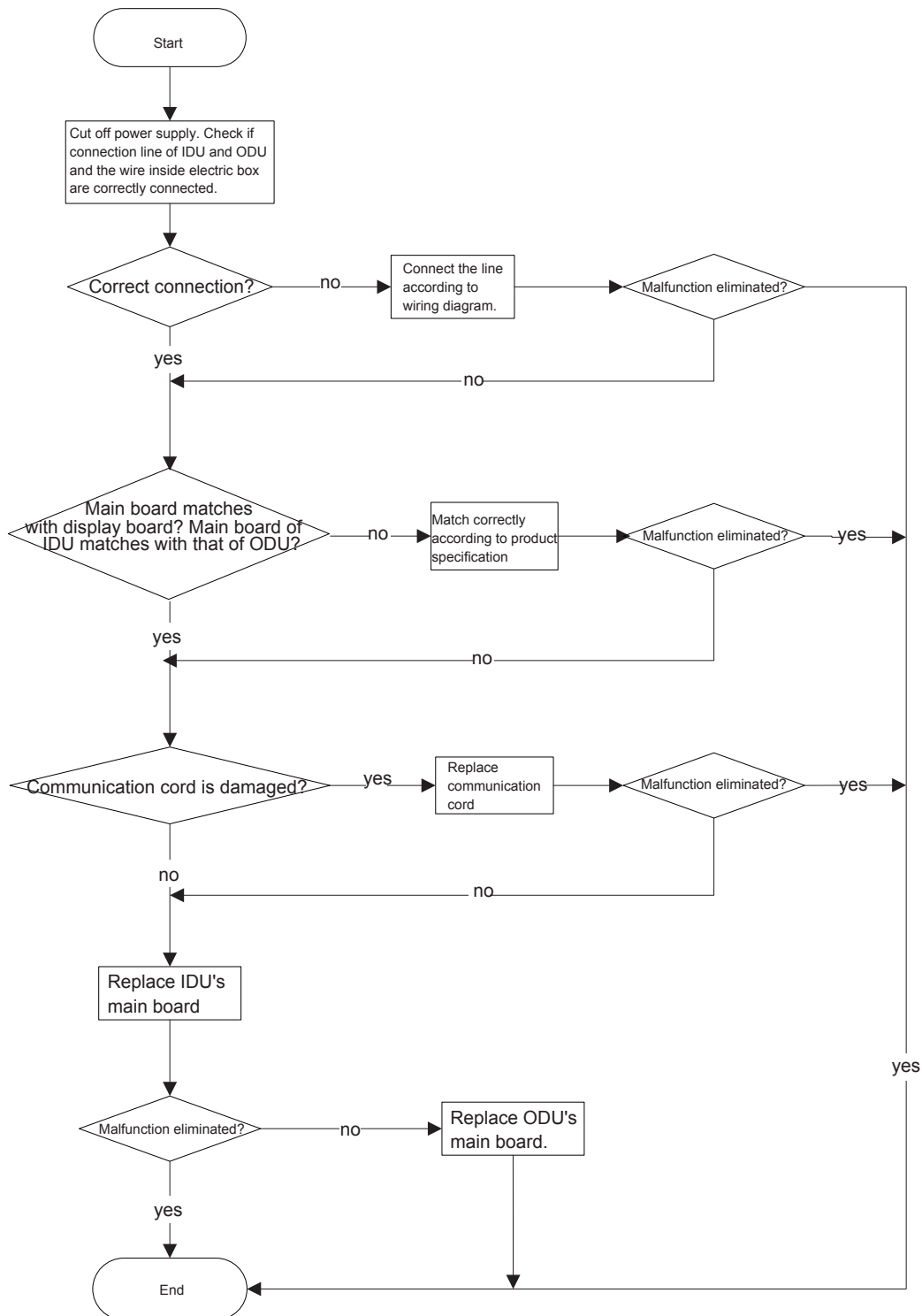

### 6. Malfunction of power supply from indoor unit to outdoor unit

Main inspection point:

Inspect the power supply plug seat with AC voltage gauge to check if the voltage between L and N is within 200VAC~240VAC;  
Check with AC voltage gauge if the voltage between N 1 and 3 of indoor wiring block is within 200VAC~240VAC;

Flow chart of Malfunction diagnosis

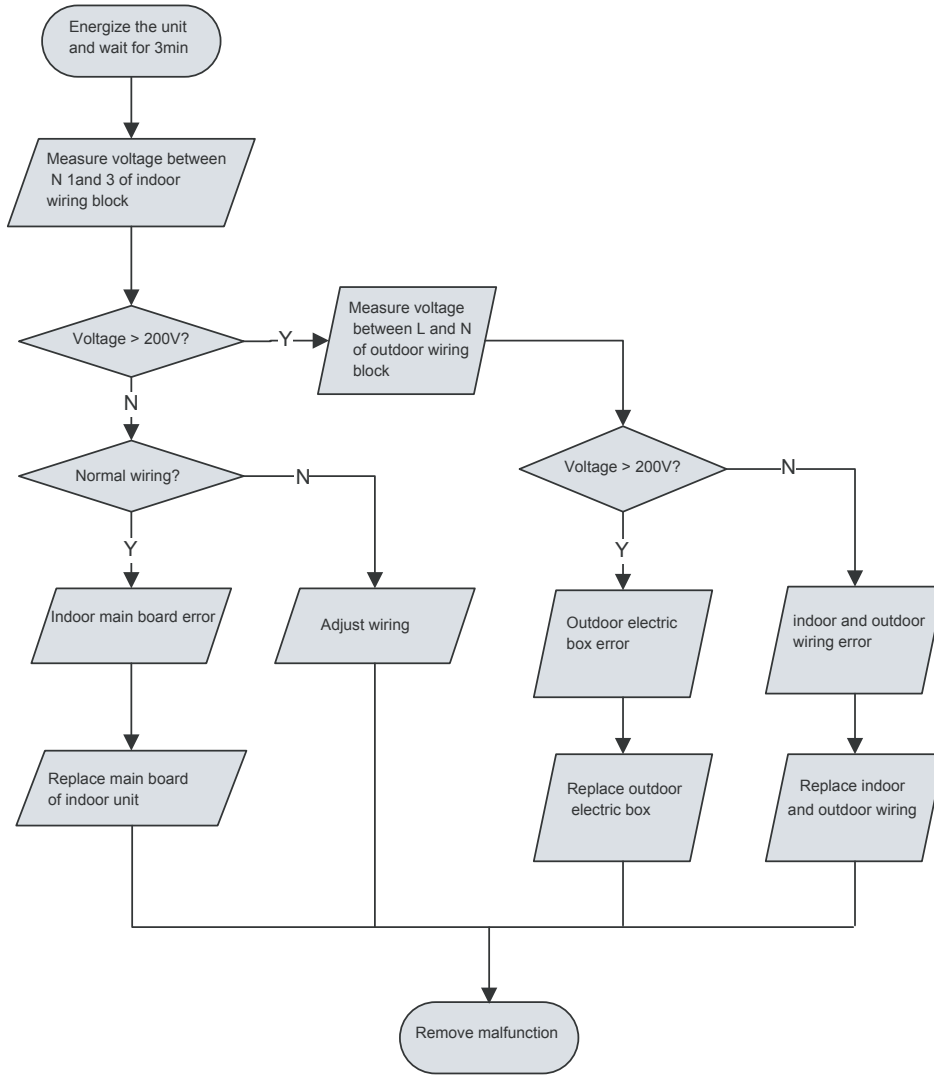

### 7. Indoor fan does not rotate and there is no feedback

Main detection point:

- Is the control panel reliably connected with the motor? Is it loose? Is the connecting sequence correct?
- Is the input voltage within the normal range (measure the voltage between L and N of the wiring block XT with AC voltage gauge.)?

Malfunction diagnosis process:

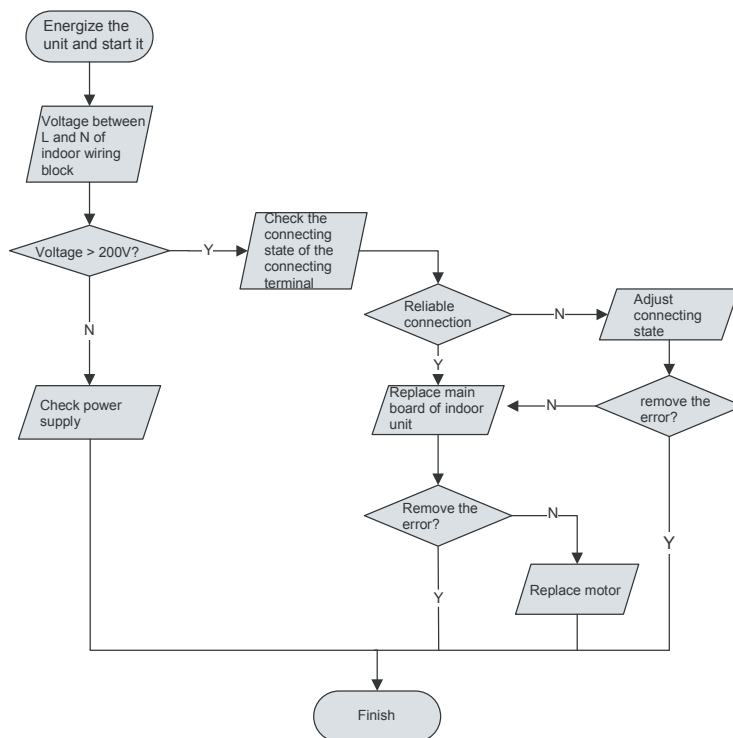

### 8. Temperature sensor malfunction

Main detection points:

- Is outdoor ambient temperature within the normal range?
- Is indoor and outdoor fan running normally?
- Is the radiating environment inside and outside the unit good enough?

Malfunction diagnosis process:

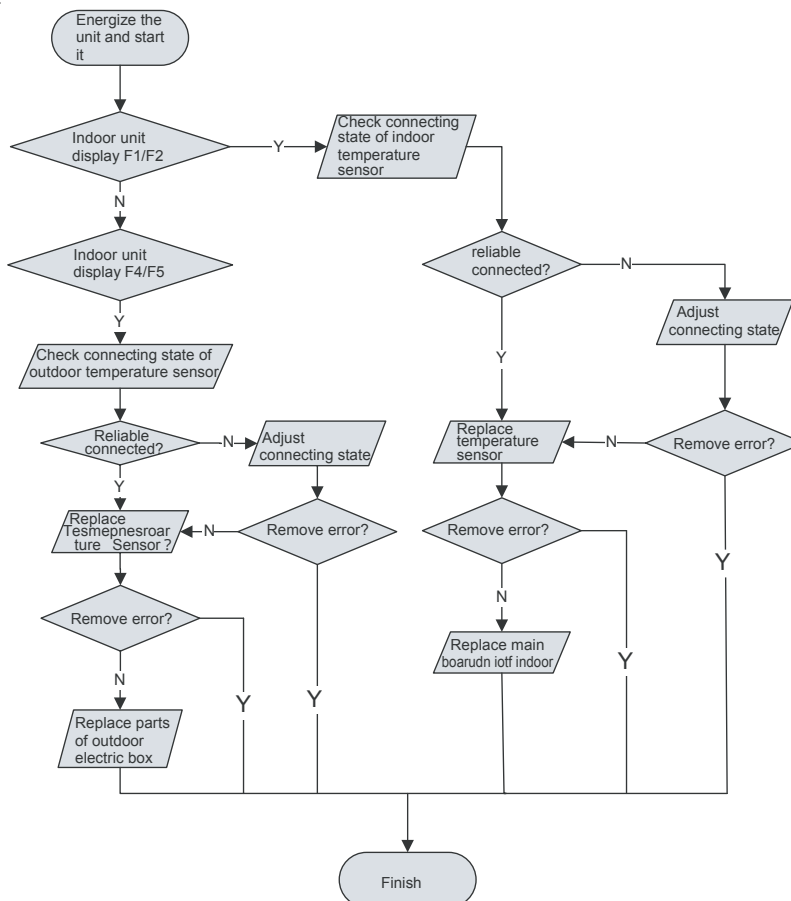

9. Malfunction diagnosis of startup failure

Main detection points:

- Is wiring of compressor correct.
- Is the stop time of compressor enough?
- Is compressor damaged?

Malfunction diagnosis process:

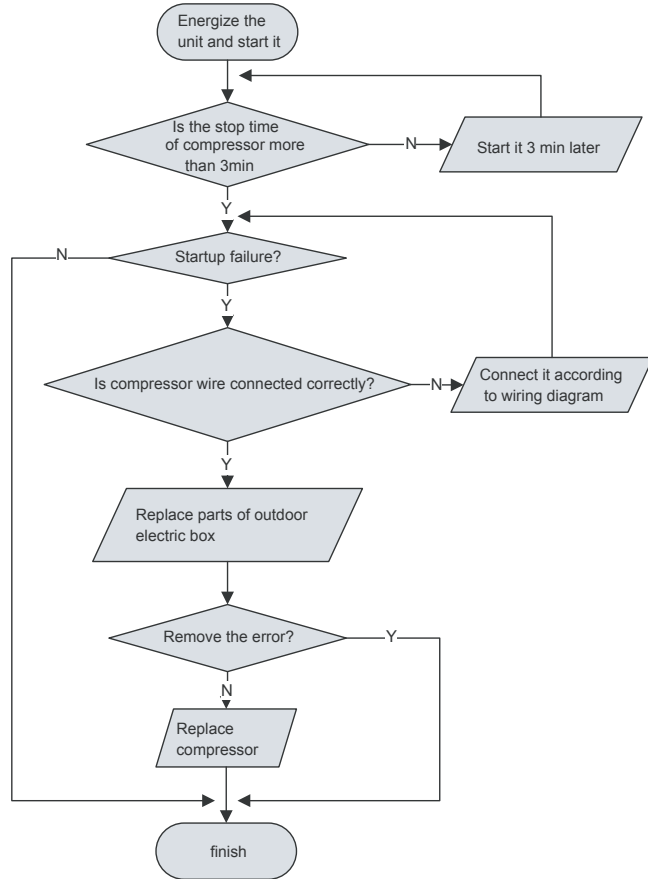

10. Diagnosis of losing synchronism for compressor

Main detection points:

- Is pressure of the system too high?
- Is voltage too low?

Malfunction diagnosis process:

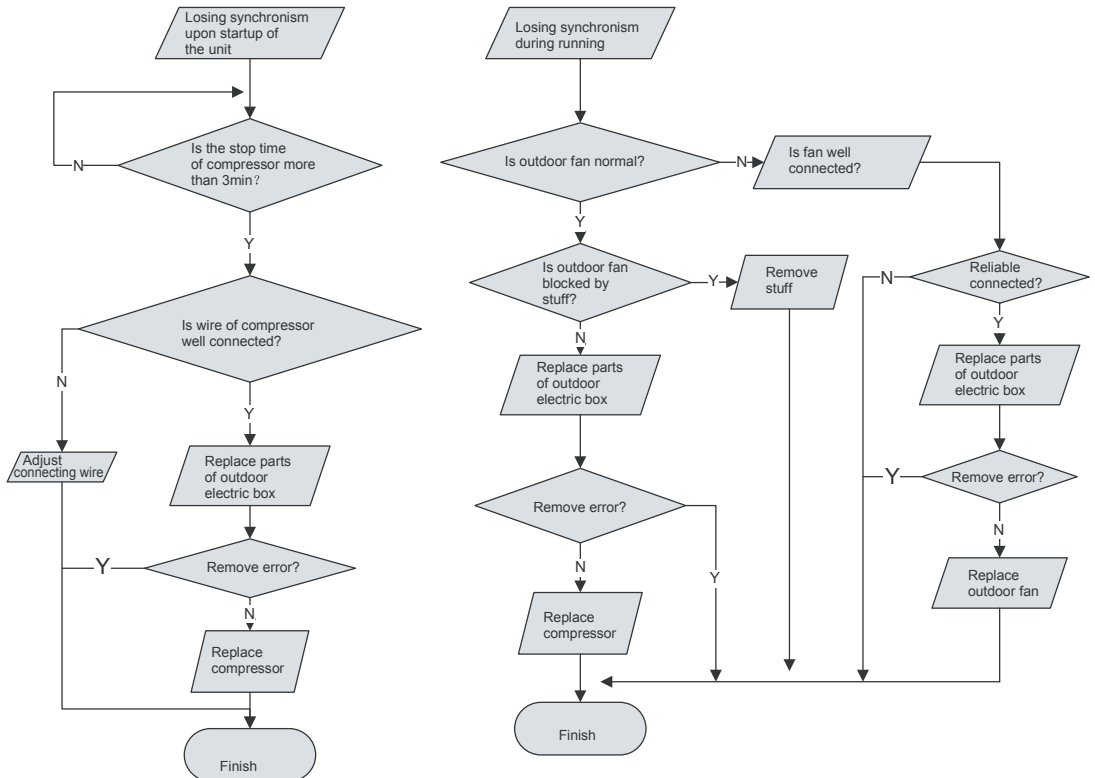



### 11. Diagnosis of overload and discharge malfunction

Main detection points:

- Is electric expansion valve well connected? Is it damaged?
- Is refrigerant leaked?
- Is overload wire connection normal?

Malfunction diagnosis process:

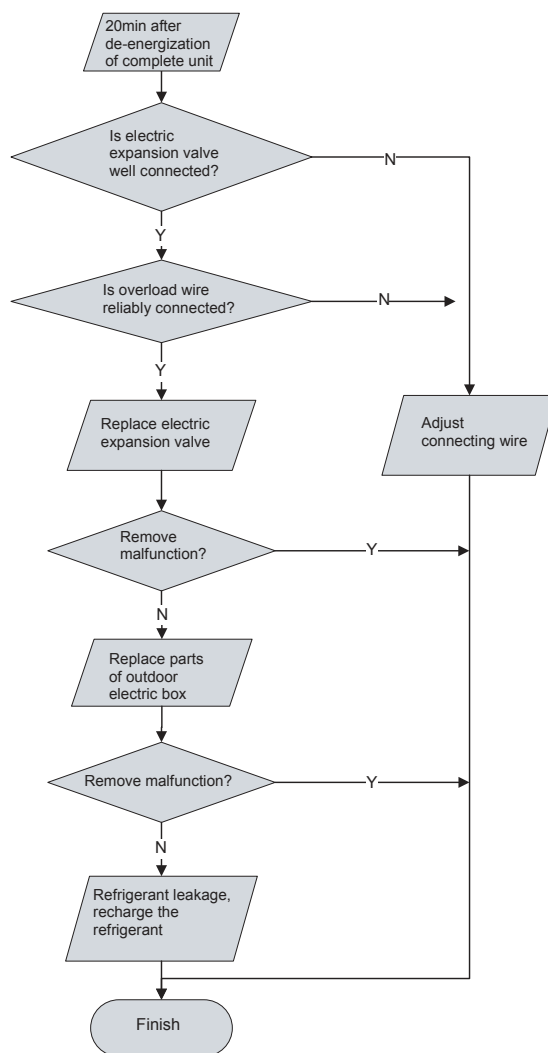

### 9.3 2-way, 3-way Valve Appearance

		2-way Valve (Liquid Side)	3-way Valve (Gas Side)	
Works		Shaft position	Shaft position	Service port
Shipping		Closed (with valve cap)	Closed (with valve cap)	Closed (with cap)
1.	Air purging (Installation)	Closed (clockwise)	Closed (clockwise)	Open (with vacuum pump)
Operation		Open (with valve cap)	Open (with valve cap)	Closed (with cap)
2.	Pumping down (Transferring)	Closed (clockwise)	Open (counter-clockwise)	Open (connected manifold gauge)
3.	Evacuation (Servicing)	Open	Open	Open (with charging cylinder)
4.	Gas charging (Servicing)	Open	Open	Open (with charging cylinder)
5.	Pressure check (Servicing)	Open	Open	Open (with charging cylinder)
6.	Gas releasing (Servicing)	Open	Open	Open (with charging cylinder)

## Air purging

**CAUTION:** Do not leak the gas in the air during Air purging.

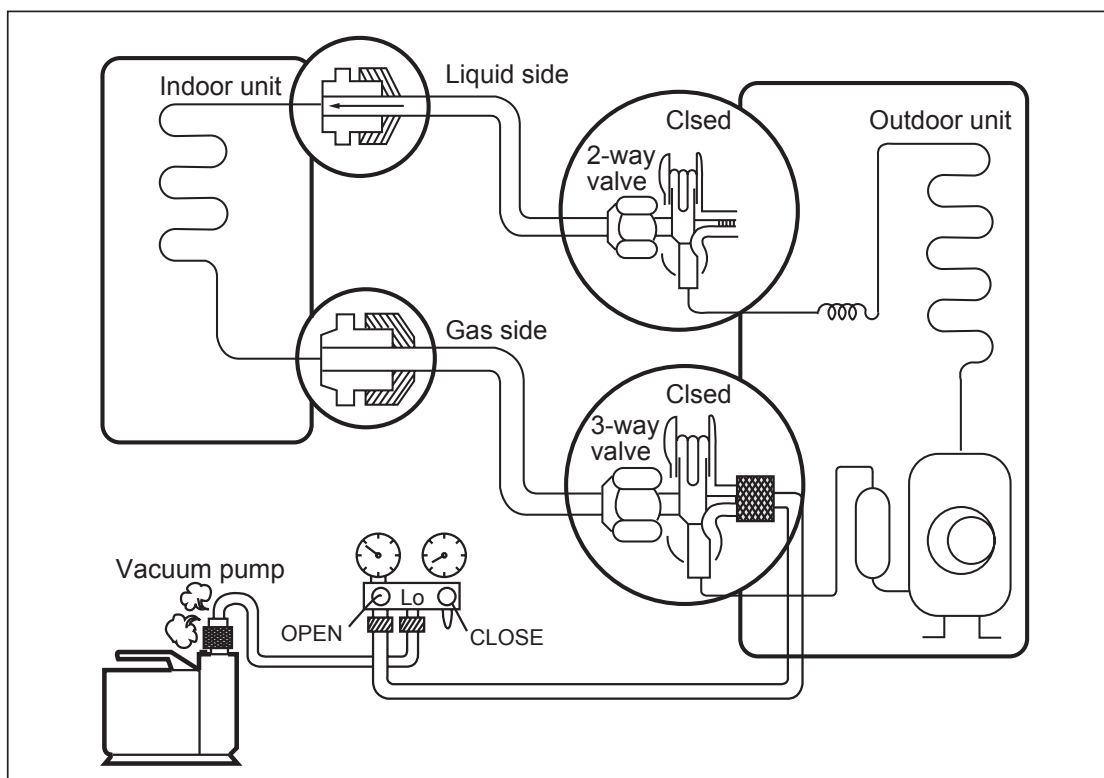

## \* Procedure

- (1) Connect the charge hose from the manifold valve to the service port of the gas side packed valve.
- (2) Connect the charge hose to the port of the vacuum pump.
- (3) Open fully the low pressure side handle of the gauge manifold valve.
- (4) Operate the vacuum pump to begin evacuating. Perform evacuating for about 15 minutes if the piping length is 20 meters (15 minutes for 20 meters) (assuming a pump capacity of 27 liters per minute). Confirm that the compound pressure gauge reading is  $-101 \text{ kPa}$  ( $-76 \text{ cmHg}$ ).
- (5) Close the low pressure valve handle of gauge manifold.
  - Check the flare connections for gas leakage.
- (6) Use torque wrench to tighten the service port nut to a torque of  $1.8 \text{ kg}\cdot\text{cm}$ .
- (7) Set the 3-way valve to the back seat.
- (8) Mount the valve stem nuts to the 2-way and 3-way valves.
- (9) Check for gas leakage.
  - At this time, especially check for gas leakage from the 2-way and 3-way valves stem nuts, and from the service port nut.

**CAUTION:**

If gas leakage are discovered in step 5 above, take the following measures :

If the gas leaks stop when the piping connections are tightened further, continue working from step 6. If the gas leaks do not stop when the connections are retightened, repair the location of the leak, discharge all of the gas through the service port, and then recharge with the specified amount of gas from a gas cylinder.

Pumping Down

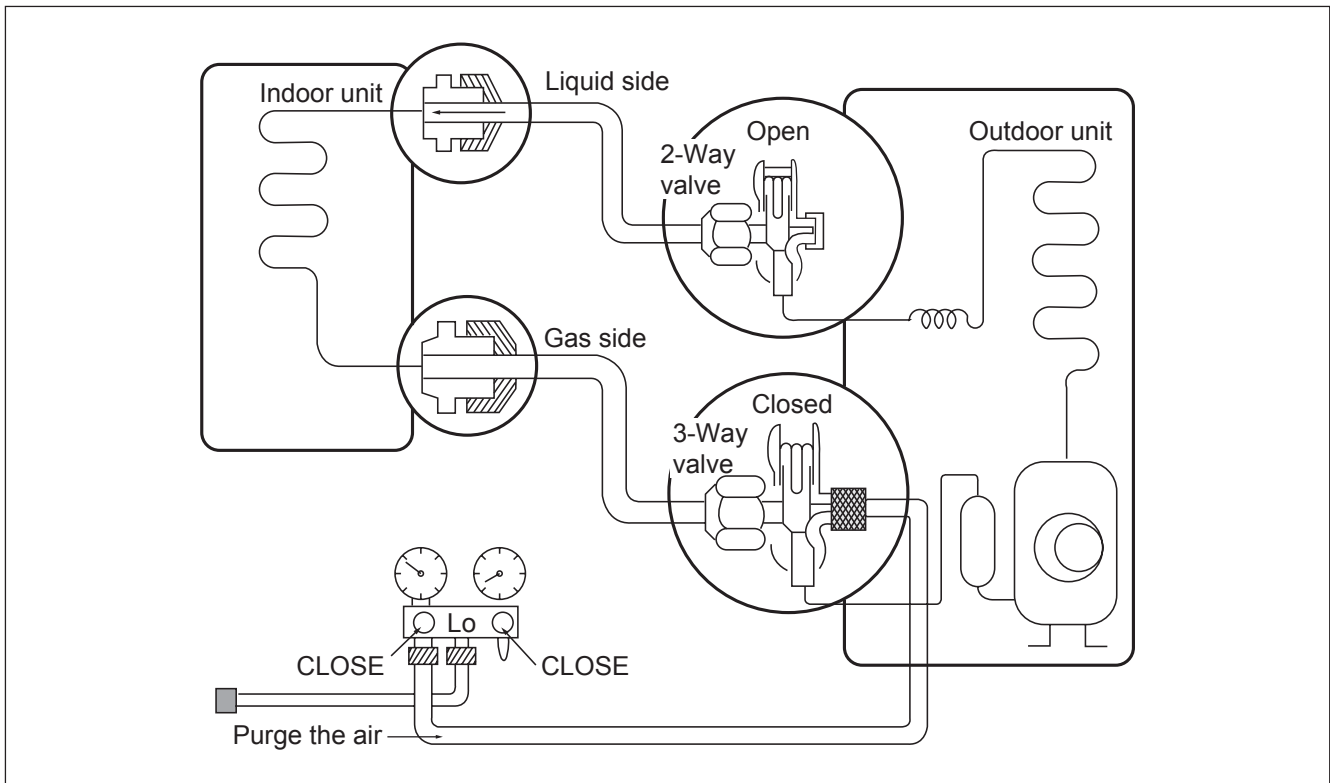

• Procedure

**(1) Confirm that both the 2-way and 3-way valves are set to the open position.**

- Remove the valve stem caps and confirm that the valve stems are in the raised position.
- Be sure to use a hexagonal wrench to operate the valve stems.

**(2) Operate the unit for 10 to 15 minutes.**

**(3) Stop operation and wait for 3 minutes, then connect the charge set to the service port of the 3-way valve.**

- Connect the charge hose with the push pin to the service port.

**(4) Air purging of the charge hose.**

- Open the low-pressure valve on the charge set slightly to air purge from the charge hose.

**(5) Set the 2-way valve to the closed position.**

**(6) Operate the air conditioner at the cooling cycle and stop it when the gauge indicates 1kg/cm<sup>2</sup>g.**

**(7) Immediately set the 3-way valve to the closed position.**

- Do this quickly so that the gauge ends up indicating 3 to 5kg/cm<sup>2</sup>g.

**(8) Disconnect the charge set, and mount the 2-way and 3-way valves stem nuts and the service port nut.**

- Use torque wrench to tighten the service port nut to a torque of 1.8 kg.m.
- Be sure to check for gas leakage.

## Re-air Purging

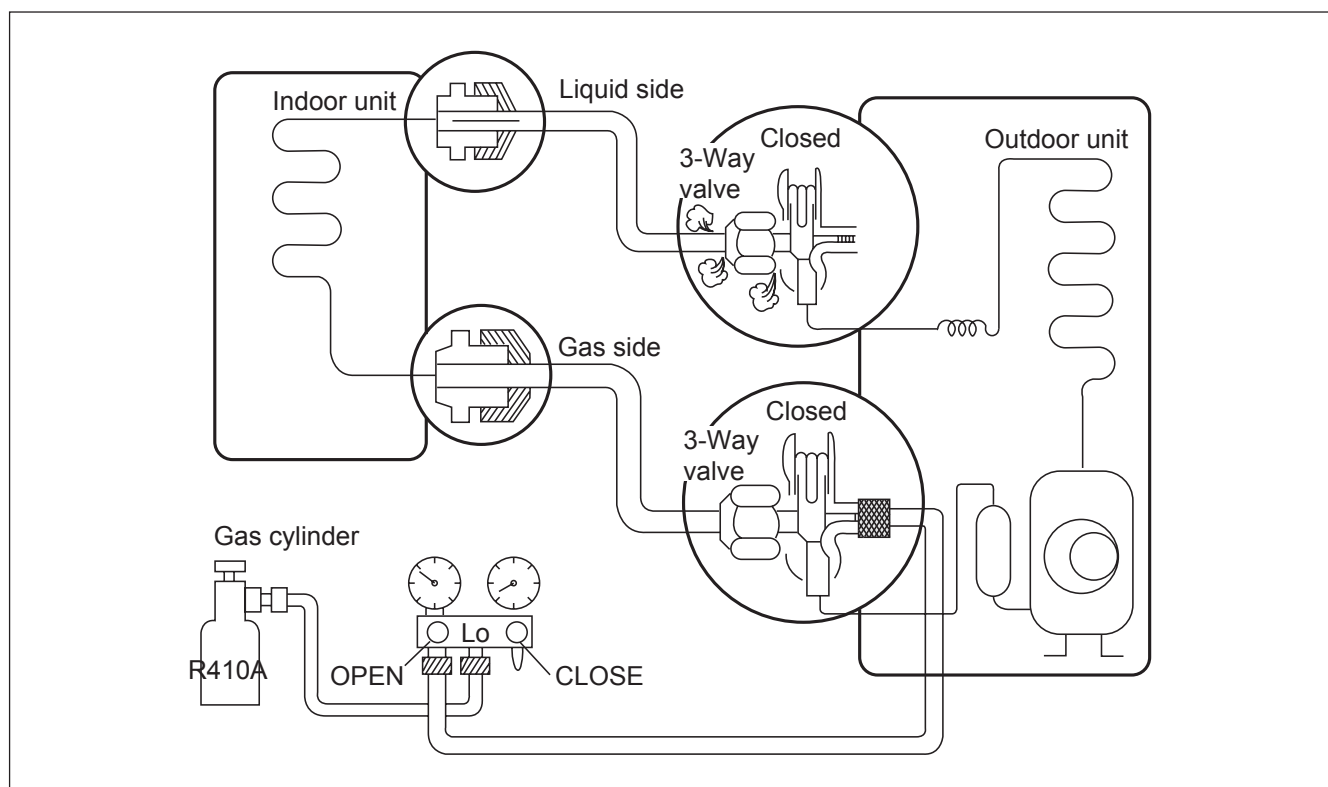

## • Procedure

(1) Confirm that both the liquid side valve and the gas side valve are set to the closed position.

(2) Connect the charge set and a gas cylinder to the service port of the Gas side valve.

– Leave the valve on the gas cylinder closed.

(3) Air purging.

– Open the valves on the gas cylinder and the charge set. Purge the air by loosening the flare nut on the liquid side valve approximately 45° or 3 seconds then closing it for 1 minute; repeat 3 times.

– After purging the air, use a torque wrench to tighten the flare nut on liquid side valve.

(4) Check for gas leakage.

– Check the flare connections for gas leakage.

(5) Discharge the refrigerant.

– Close the valve on the gas cylinder and discharge the refrigerant until the gauge indicates 3 to 5 kg/cm<sup>2</sup>g.

(6) Disconnect the charge set and the gas cylinder, and set the Liquid side and Gas side valves to the open position.

– Be sure to use a hexagonal wrench to operate the valve stems.

(7) Mount the valve stem nuts and the service port nut.

– Use torque wrench to tighten the service port nut to a torque of 1.8 kg.m.

– Be sure to check for gas leakage.

**CAUTION: Do not leak the gas in the air during Air Purging.**

**Balance Refrigerant of the 3-way Valve  
(Gas leakage)**

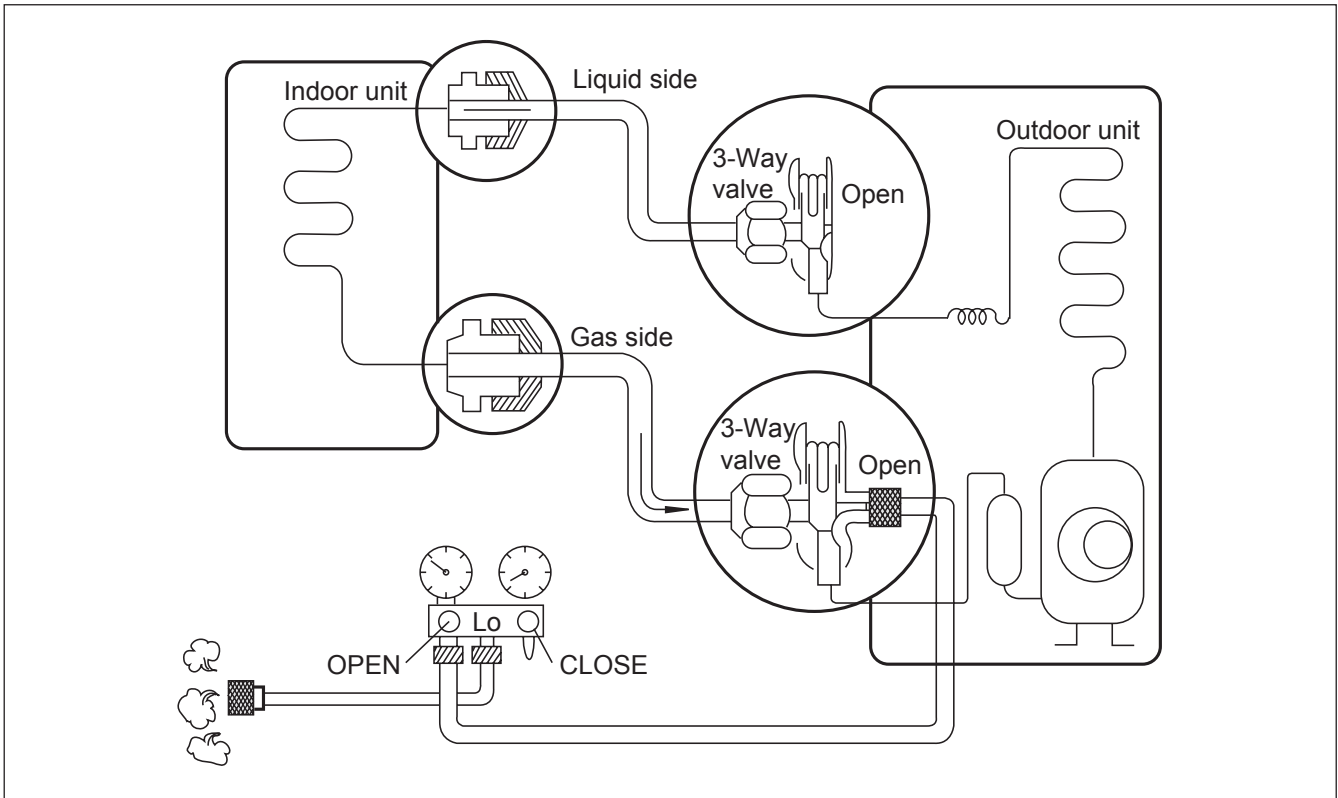

• Procedure

**(1) Confirm that both the 2-way and 3-way valves are set to the back seat.**

**(2) Connect the charge set to the 3-way valves port.**

- Leave the valve on the charge set closed.
- Connect the charge hose to the service port.

**(3) Open the valve (Lo side) on the charge set and discharge the refrigerant until the gauge indicates 0 kg/cm<sup>2</sup>G.**

- If there is no air in the refrigerant cycle (the pressure when the air conditioner is not running is higher than 1kg/cm<sup>2</sup>G), discharge the refrigerant until the gauge indicates 0.5 to 1kg/cm<sup>2</sup>G. if this is the case, it will not be necessary to apply an evacuation.
- Discharge the refrigerant gradually; if it is discharged too suddenly, the refrigeration oil will also be discharged.

## Evacuation

(All amount of refrigerant leaked)

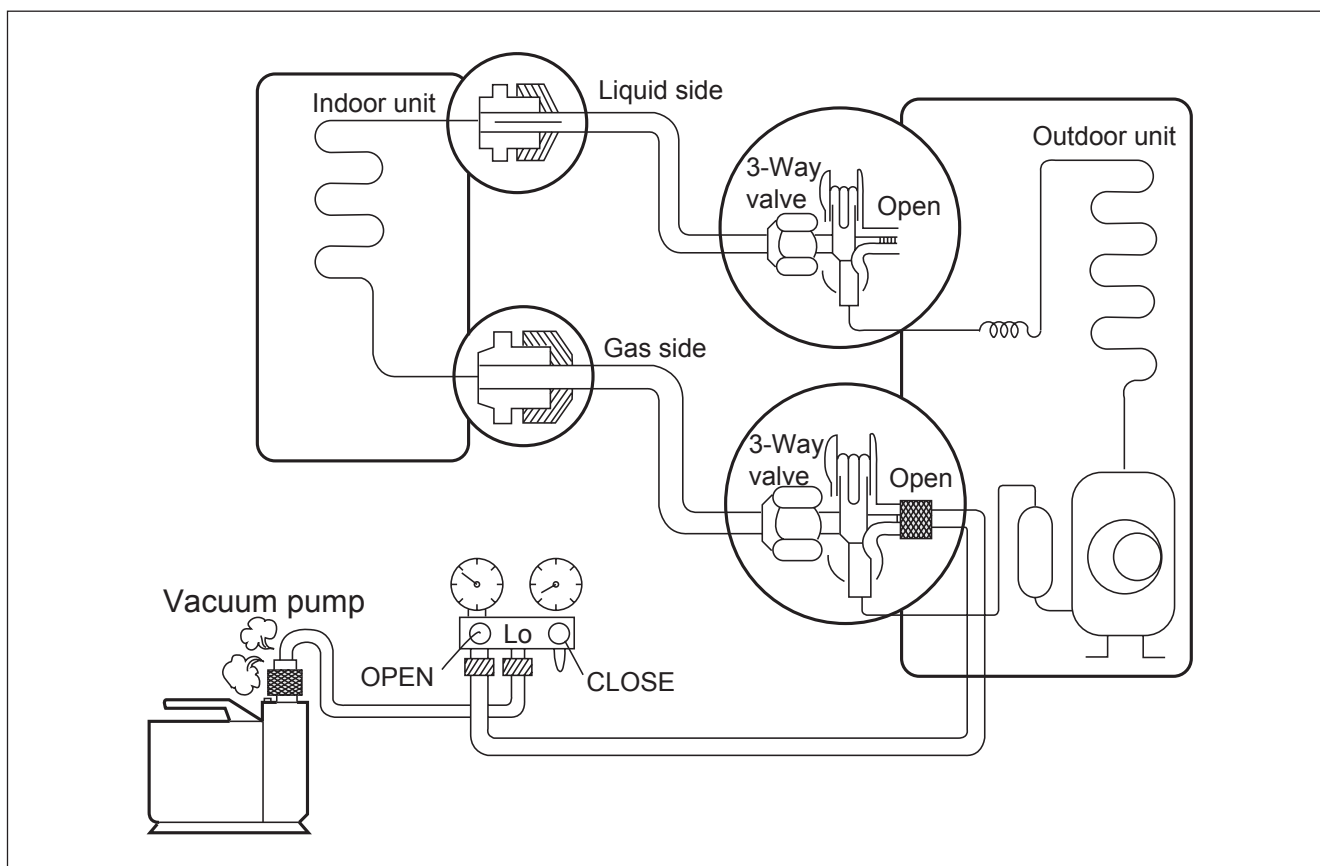

## • Procedure

(1) Connect the vacuum pump to the center hose of charge set center hose

(2) Evacuation for approximately one hour.

– Confirm that the gauge needle has moved toward -76cmHg (vacuum of 4 mmHg or less).

(3) Close the valve (Lo side) on the charge set, turn off the vacuum pump, and confirm that the gauge needle does not move (approximately 5 minutes after turning off the vacuum pump).

(4) Disconnect the charge hose from the vacuum pump.

– Vacuum pump oil.

If the vacuum pump oil becomes dirty or depleted, replenish as needed.

## Gas Charging (After Evacuation)

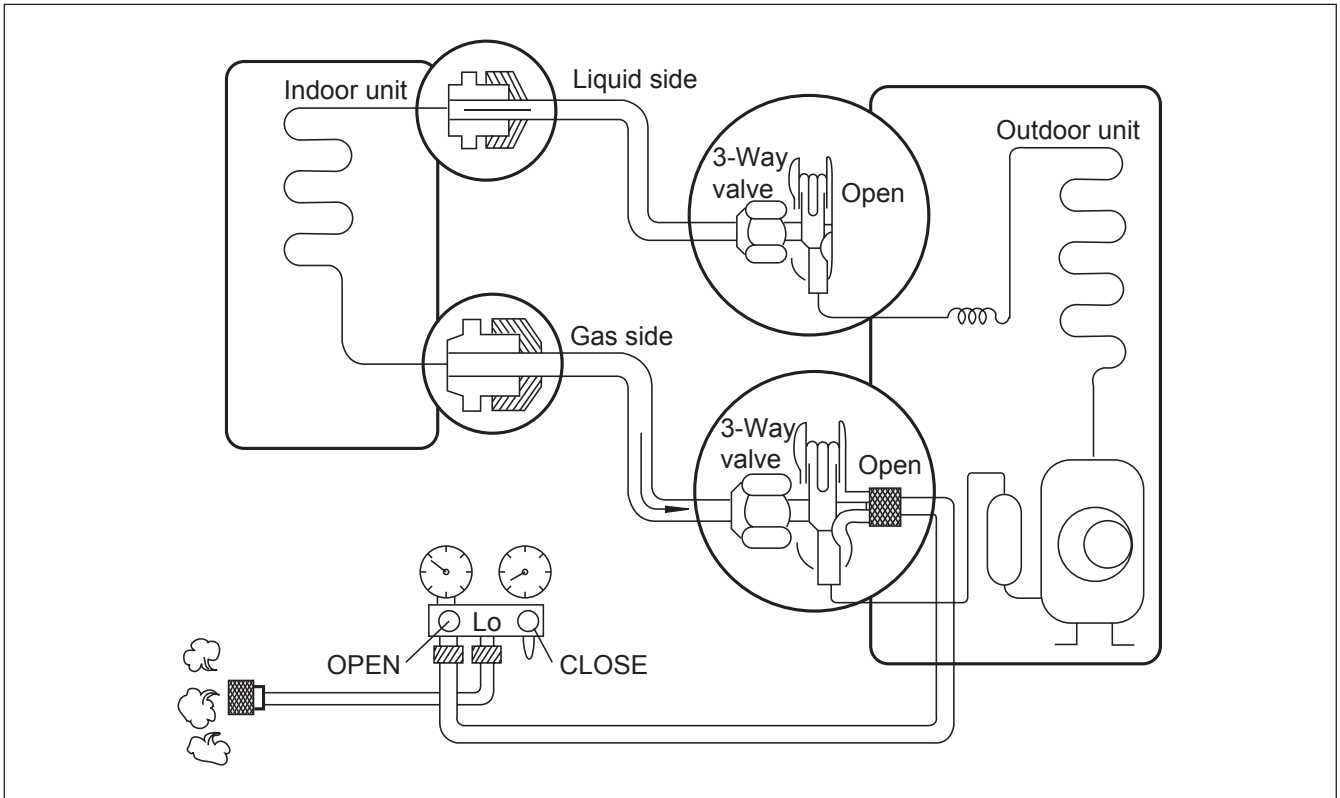

### • Procedure

#### (1) Connect the charge hose to the charging cylinder.

- Connect the charge hose which you dis-connected from the vacuum pump to the valve at the bottom of the cylinder.
- If you are using a gas cylinder, also use a scale and reverse the cylinder so that the system can be charged with liquid.

#### (2) Purge the air from the charge hose.

- Open the valve at the bottom of the cylinder and press the check valve on the charge set to purge the air. (Be careful of the liquid refrigerant).

#### (3) Open the valve (Lo side on the charge set and charge the system with liquid refrigerant.

- If the system can not be charged with the specified amount of refrigerant, it can be charged with a little at a time (approximately 150g each time) while operating the air conditioner in the cooling cycle; however, one time is not sufficient, wait approximately 1 minute and then repeat the procedure (pumping down-pin).

This is different from previous procedures. Because you are charging with liquid refrigerant from the gas side, absolutely do not attempt to charge with larger amounts of liquid refrigerant while operating the air conditioner.

#### (4) Immediately disconnect the charge hose from the 3-way valves service port.

- Stopping partway will allow the gas to be discharged.
- If the system has been charged with liquid refrigerant while operating the air conditioner turn off the air conditioner before disconnecting the hose.

#### (5) Mount the valve stem nuts and the service port nut.

- Use torque wrench to tighten the service port nut to a torque of 1.8 kg.m.
- Be sure to check for gas leakage.

**Note:** The information above is for reference only.



## 9.4 Troubleshooting for Normal Malfunction

### 1. Air Conditioner Can't be Started Up

Possible Causes	Discriminating Method (Air conditioner Status)	Troubleshooting
No power supply, or poor connection for power plug	After energization, operation indicator isn't bright and the buzzer can't give out sound	Confirm whether it's due to power failure. If yes, wait for power recovery. If not, check power supply circuit and make sure the power plug is connected well.
Wrong wire connection between indoor unit and outdoor unit, or poor connection for wiring terminals	Under normal power supply circumstances, operation indicator isn't bright after energization	Check the circuit according to circuit diagram and connect wires correctly. Make sure all wiring terminals are connected firmly
Electric leakage for air conditioner	After energization, room circuit breaker trips off at once	Make sure the air conditioner is grounded reliably Make sure wires of air conditioner is connected correctly Check the wiring inside air conditioner. Check whether the insulation layer of power cord is damaged; if yes, place the power cord.
Model selection for air switch is improper	After energization, air switch trips off	Select proper air switch
Malfunction of remote controller	After energization, operation indicator is bright, while no display on remote controller or buttons have no action.	Replace batteries for remote controller Repair or replace remote controller

### 2. Poor Cooling (Heating) for Air Conditioner

Possible Causes	Discriminating Method (Air conditioner Status)	Troubleshooting
Set temperature is improper	Observe the set temperature on remote controller	Adjust the set temperature
Rotation speed of the IDU fan motor is set too low	Small wind blow	Set the fan speed at high or medium
Filter of indoor unit is blocked	Check the filter to see it's blocked	Clean the filter
Installation position for indoor unit and outdoor unit is improper	Check whether the installation position is proper according to installation requirement for air conditioner	Adjust the installation position, and install the rainproof and sunproof for outdoor unit
Refrigerant is leaking	Discharged air temperature during cooling is higher than normal discharged wind temperature; Discharged air temperature during heating is lower than normal discharged wind temperature; Unit's pressure is much lower than regulated range	Find out the leakage causes and deal with it. Add refrigerant.
Malfunction of 4-way valve	Blow cold wind during heating	Replace the 4-way valve
Malfunction of capillary	Discharged air temperature during cooling is higher than normal discharged wind temperature; Discharged air temperature during heating is lower than normal discharged wind temperature; Unit's pressure is much lower than regulated range. If refrigerant isn't leaking, part of capillary is blocked	Replace the capillary
Flow volume of valve is insufficient	The pressure of valves is much lower than that stated in the specification	Open the valve completely
Malfunction of horizontal louver	Horizontal louver can't swing	Refer to point 3 of maintenance method for details
Malfunction of the IDU fan motor	The IDU fan motor can't operate	Refer to troubleshooting for H6 for maintenance method in details
Malfunction of the ODU fan motor	The ODU fan motor can't operate	Refer to point 4 of maintenance method for details
Malfunction of compressor	Compressor can't operate	Refer to point 5 of maintenance method for details

### 3. Horizontal Louver Can't Swing

Possible Causes	Discriminating Method (Air conditioner Status)	Troubleshooting
Wrong wire connection, or poor connection	Check the wiring status according to circuit diagram	Connect wires according to wiring diagram to make sure all wiring terminals are connected firmly
Stepping motor is damaged	Stepping motor can't operate	Repair or replace stepping motor
Main board is damaged	Others are all normal, while horizontal louver can't operate	Replace the main board with the same model

**4. ODU Fan Motor Can't Operate**

Possible causes	Discriminating method (air conditioner status)	Troubleshooting
Wrong wire connection, or poor connection	Check the wiring status according to circuit diagram	Connect wires according to wiring diagram to make sure all wiring terminals are connected firmly
Capacity of the ODU fan motor is damaged	Measure the capacity of fan capacitor with an universal meter and find that the capacity is out of the deviation range indicated on the nameplate of fan capacitor.	Replace the capacity of fan
Power voltage is a little low or high	Use universal meter to measure the power supply voltage. The voltage is a little high or low	Suggest to equip with voltage regulator
Motor of outdoor unit is damaged	When unit is on, cooling/heating performance is bad and ODU compressor generates a lot of noise and heat.	Change compressor oil and refrigerant. If no better, replace the compressor with a new one

**5. Compressor Can't Operate**

Possible causes	Discriminating method (air conditioner status)	Troubleshooting
Wrong wire connection, or poor connection	Check the wiring status according to circuit diagram	Connect wires according to wiring diagram to make sure all wiring terminals are connected firmly
Capacity of compressor is damaged	Measure the capacity of fan capacitor with an universal meter and find that the capacity is out of the deviation range indicated on the nameplate of fan capacitor.	Replace the compressor capacitor
Power voltage is a little low or high	Use universal meter to measure the power supply voltage. The voltage is a little high or low	Suggest to equip with voltage regulator
Coil of compressor is burnt out	Use universal meter to measure the resistance between compressor terminals and it's 0	Repair or replace compressor
Cylinder of compressor is blocked	Compressor can't operate	Repair or replace compressor

**6. Air Conditioner is Leaking**

Possible causes	Discriminating method (air conditioner status)	Troubleshooting
Drain pipe is blocked	Water leaking from indoor unit	Eliminate the foreign objects inside the drain pipe
Drain pipe is broken	Water leaking from drain pipe	Replace drain pipe
Wrapping is not tight	Water leaking from the pipe connection place of indoor unit	Wrap it again and bundle it tightly

**7. Abnormal Sound and Vibration**

Possible causes	Discriminating method (air conditioner status)	Troubleshooting
When turn on or turn off the unit, the panel and other parts will expand and there's abnormal sound	There's the sound of "PAPA"	Normal phenomenon. Abnormal sound will disappear after a few minutes.
When turn on or turn off the unit, there's abnormal sound due to flow of refrigerant inside air conditioner	Water-running sound can be heard	Normal phenomenon. Abnormal sound will disappear after a few minutes.
Foreign objects inside the indoor unit or there're parts touching together inside the indoor unit	There's abnormal sound fro indoor unit	Remove foreign objects. Adjust all parts' position of indoor unit, tighten screws and stick damping plaster between connected parts
Foreign objects inside the outdoor unit or there're parts touching together inside the outdoor unit	There's abnormal sound fro outdoor unit	Remove foreign objects. Adjust all parts' position of outdoor unit, tighten screws and stick damping plaster between connected parts
Short circuit inside the magnetic coil	During heating, the way valve has abnormal electromagnetic sound	Replace magnetic coil
Abnormal shake of compressor	Outdoor unit gives out abnormal sound	Adjust the support foot mat of compressor, tighten the bolts
Abnormal sound inside the compressor	Abnormal sound inside the compressor	If add too much refrigerant during maintenance, please reduce refrigerant properly. Replace compressor for other circumstances.

# 10. Exploded View and Parts List

## 10.1 Indoor Unit

MWM09Y1J MWM12Y1J

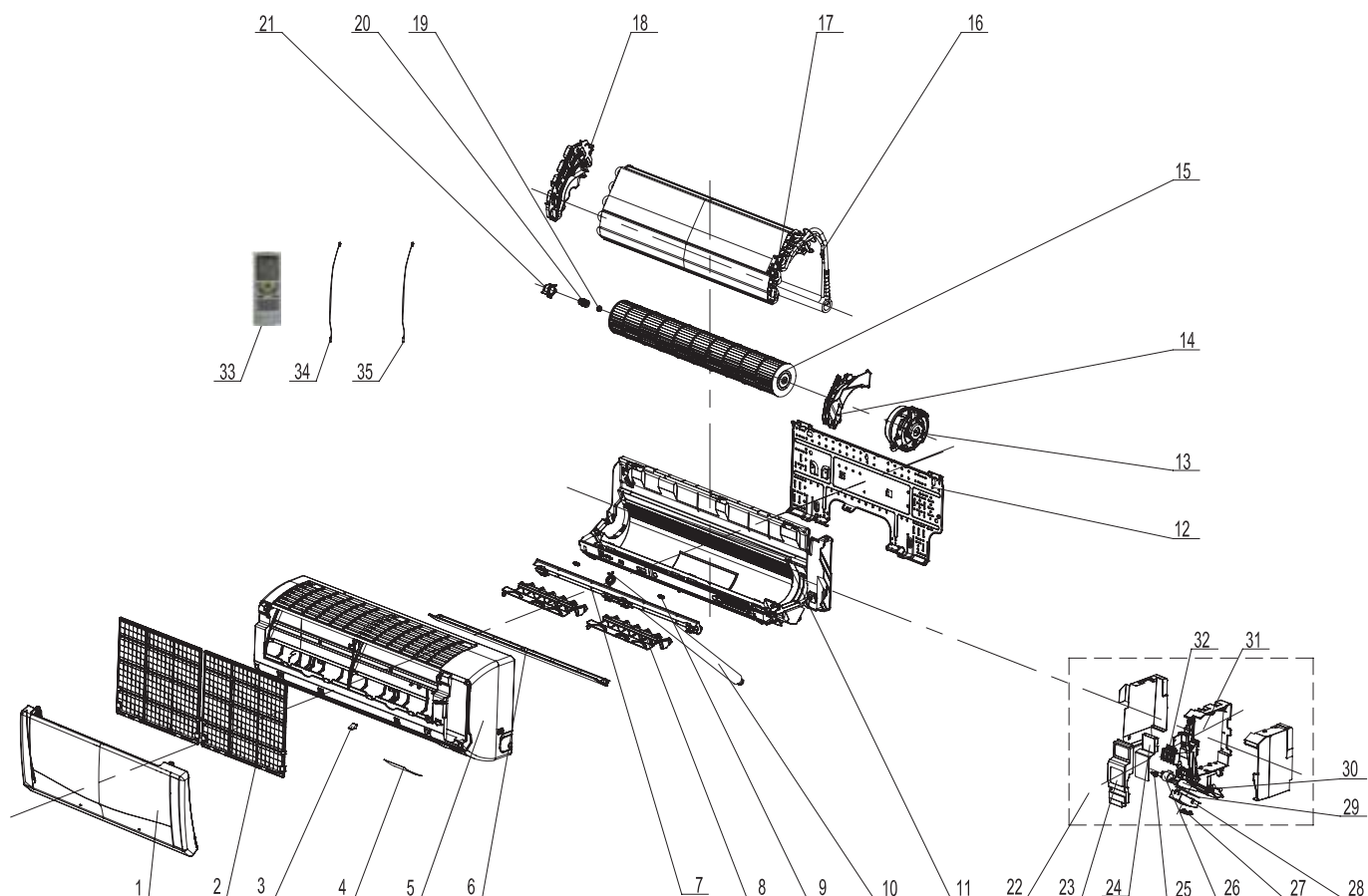

No.	Description	Part Code		Qty
		MWM09Y1J	MWM12Y1J	
1	Front Panel	69700336	69700336	1
2	Filter Sub-Assy	69700337	69700337	2
3	Screw Cover	69700338	69700338	1
4	Membrane	69700339	69700339	1
5	Front Case Assy	69700340	69700340	1
6	Guide Louver	69700341	69700341	1
7	Helicoid Tongue	69700342	69700342	1
8	Air Louver	69700330	69700330	2
9	Shaft of Guide Louver	69700343	69700343	2
10	Drainage Pipe Sub-assy	69700344	69700344	1
11	Rear Case assy	69700345	69700345	1
12	Wall Mounting Frame	69700346	69700346	1
13	Motor Sub-Assy	69700347	69700347	1
14	Motor Press Plate	69700348	69700348	1
15	Cross Flow Fan	69700349	69700349	1
16	Evaporator Assy	69700350	69700350	1
17	Temp Sensor Sleeving	69700351	69700351	1
18	Evaporator Support	69700352	69700352	1
19	Fan Bearing	68700159	68700159	1
20	Bearing Holder	69700353	69700353	1
21	Axil Bush Sub-assy	69700354	69700354	1
22	Electric Box Assy	69700364	69700355	1
23	Electric Box Cover Sub-Assy	69700356	69700356	1
24	Shield Cover	69700357	69700357	1
25	Crank	69700358	69700358	1
26	Stepping Motor	69700359	69700359	1
27	Indicator Shield Cover	69700293	69700293	1
28	Indicator Light Cover	69700294	69700294	1
29	Display Board	69700295	69700295	1
30	Electric Box Sub-Assy	69700365	69700360	1
31	Main Board	69700361	69700361	1
32	Terminal Board	69700130	69700130	1
33	Remote Controller	69700313	69700313	1
34	Temperature Sensor	69700362	69700362	1
35	Temperature Sensor	69700363	69700363	1

Above data is subject to change without notice.

## 10.2 Outdoor Unit

MRM09Y1J MRM12Y1J

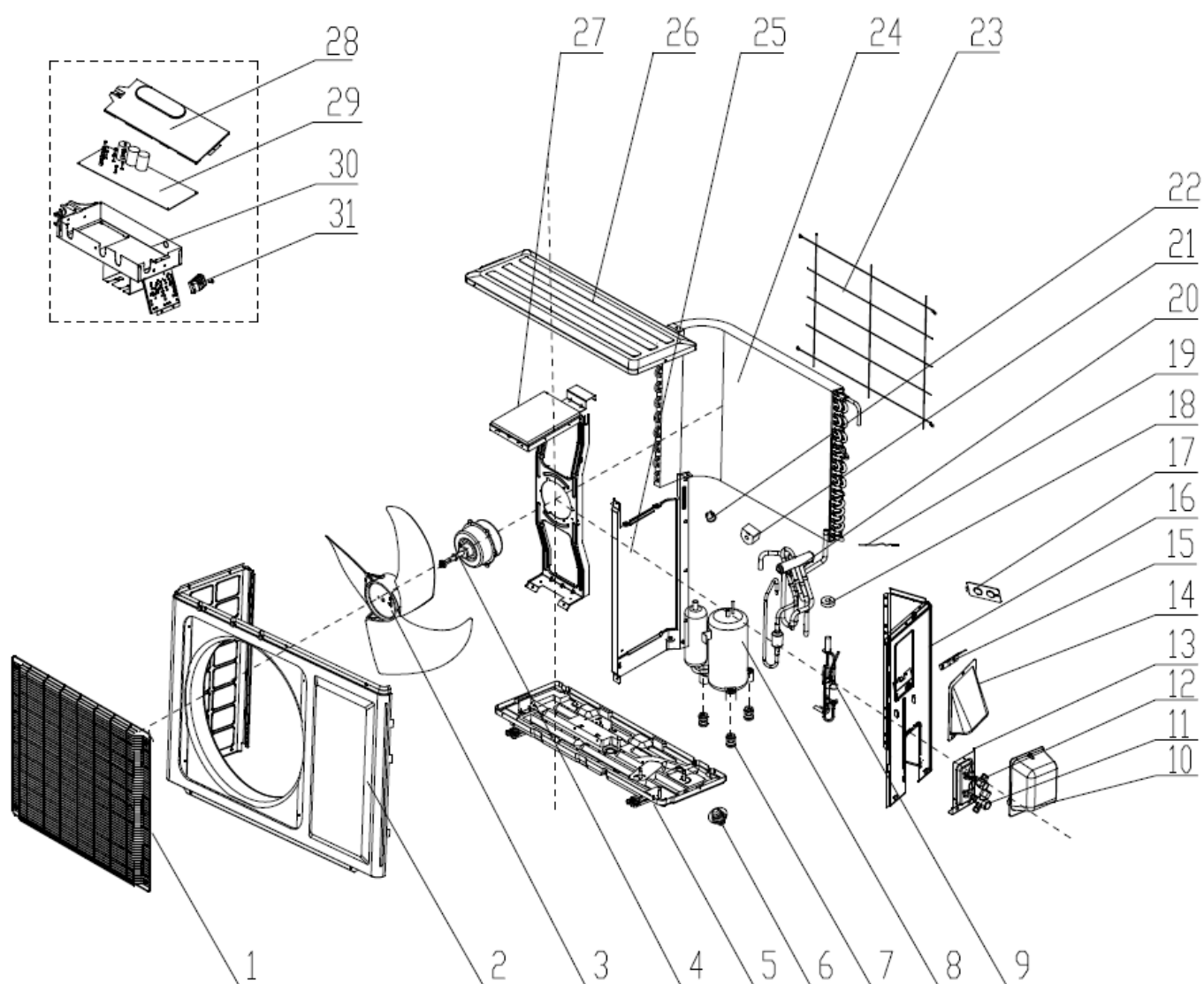

No.	Description	Part Code		Qty
		MRM09Y1J	MRM12Y1J	
1	Front Grill	69700000	69700000	1
2	Cabinet	69700273	69700273	2
3	Axial Flow Fan	69700280	69700280	1
4	Fan Motor	69700281	69700281	1
5	Chassis Sub-assy	69700270	69700270	1
6	Drainage Connector	69700164	69700164	1
7	Compressor Gasket	69700284	69700284	1
8	Compressor and Fittings	69700268	69700268	2
9	Electric Expansion Valve Sub-	69700288	69700009	2
10	Valve Cover	69700289	69700010	1
11	Valve	69700009	69700011	1
12	Valve	69700010	69700276	1
13	Valve Support	69700011	69700272	1
14	Cable Cross Plate 2	69700286	69700014	1
15	Cable Cross Plate 1	69700276	69700283	1
16	Right Side Plate Assy	69700272	69700279	1
17	Cover of Pass Wire	69700014	69700278	1
18	Electric Expand Valve Fitting	69700291	69700213	1
19	Temperature Sensor	69700283		1
20	4-Way Valve Assy	69700278	69700274	1
21	Magnet Coil	69700213	69700269	1
22	Compressor Overload	69700285	69700271	1
23	Rear Grill	69700274	69700025	1
24	Condenser Assy	69700269	69700275	1
25	Clapboard Sub-Assy	69700271	69700027	1
26	Top Cover Plate	69700025	69700282	1
27	Motor Support Spot Weld	69700026	69700277	1
28	Electric Box Cover Sub-Assy	69700027	69700196	1
29	Main Board	69700290	69700000	1
30	Electric Box Assy	69700287	69700273	1
31	Terminal Board	69700196	69700280	1
32	Front Grill	69700000	69700281	1
33	Cabinet	69700273	69700270	1
34	Axial Flow Fan	69700280	69700164	1
35	Fan Motor	69700281	69700284	1

Above data is subject to change without notice.

# 11. Removal Procedure

**Warning:** Be sure to wait for a minimum of 20 minutes after turning off all power supplies and discharge the refrigerant completely before removal.

## 11.1 Removal Procedure of Indoor Unit

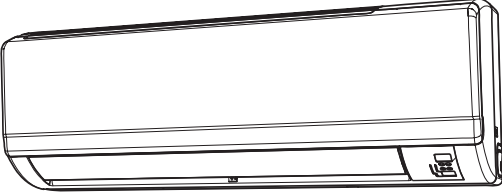
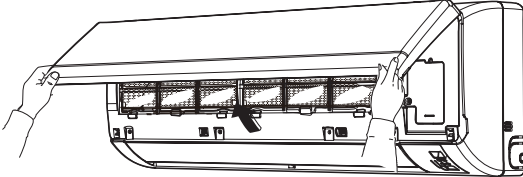
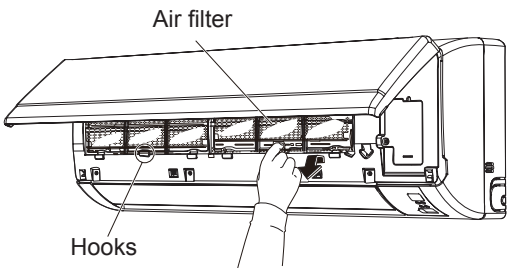
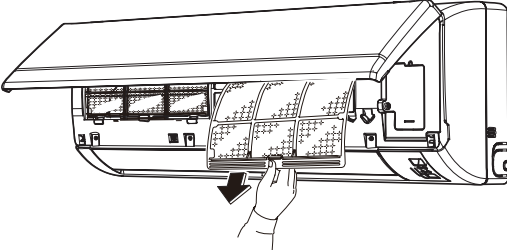
Steps	Procedure	Points
1. External features		<p>If ON/OFF button is kept pushing for 5 seconds, a forced cooling operation will be carried out for approx. 15 minutes.</p>
2. Removing air filters	<p>a Pull protrusions on left and right sides of panel with fingers and open front panel all the way.</p>  <p>b Lift center section of air filter and disengage hooks.</p>  <p>c Remove air filter by pulling forward.</p> 	<p>Left and right filters are interchangeable.</p> <p>To re-install, insert air filter along the guide.</p>



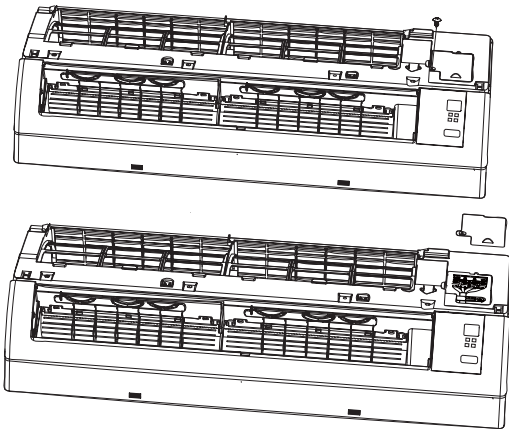
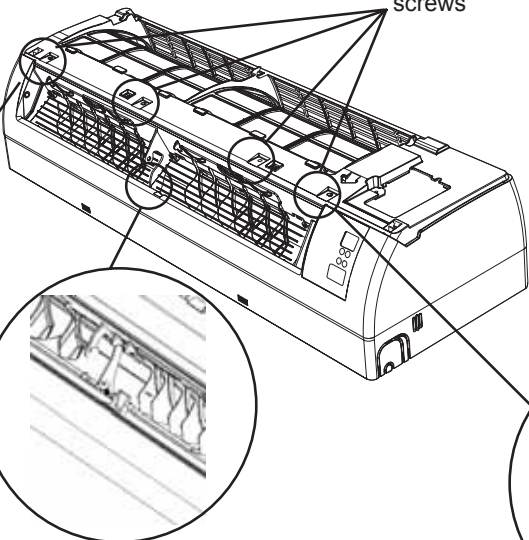
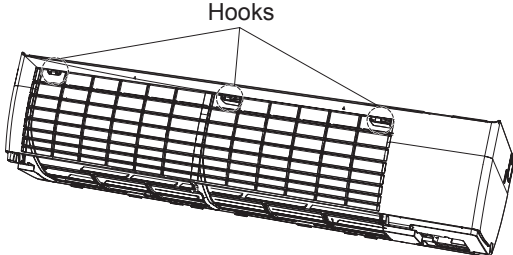
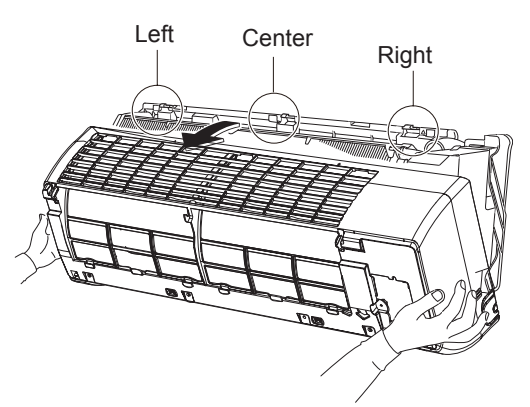

Steps	Procedure	Points
4. Opening and closing of service cover		<p>A switch for field setting is not provided in particular.</p>
5. Removal of front grille assembly	<p>a</p> <p>Remove the 5 screws, in the right and the left, which fix the main body with the front grille.</p>  <p>screws</p> <p>b</p> <p>Disengage the 3 hooks on the upper part. In case that the hooks are not pressed from above, remove the front panel and then remove the grille while pushing the hook through a clearance between the front grille and the heat exchanger.</p>  <p>Hooks</p> <p>c</p> <p>The front grille can be removed in a manner to pull out the upper part forward and lift up the lower part.</p>  <p>Left Center Right</p>	<p>Screw stoppers inside the flap which were equipped in the existing models are not provided.</p> <p>At the upper part there are 2 hooks in the left and the right.</p> <p>Disengage the hooks by pressing knobs with a screwdriver.</p>

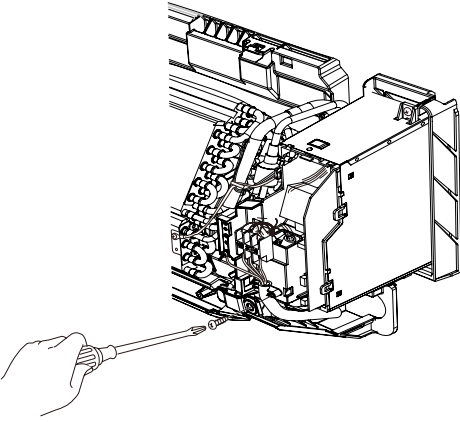
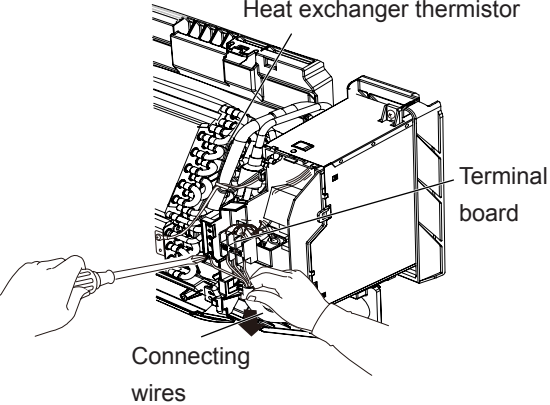
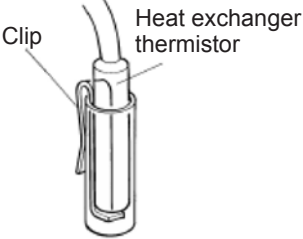
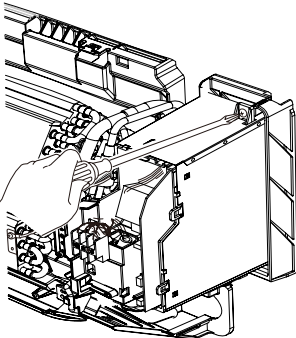
Steps	Procedure	Points
<b>6. Remove electrical box</b>		
a	Disconnect the Cable clamp 	Pay attention to the direction of the retainer of the thermistor so that the retainer will not touch the harness (same as the existing models.)
b	Remove Temperature Sensor; Disconnect the connection wires. Twist off the earthing screw fixing the evaporator; Pull out the all the wiring terminals 	Take care not to losw the clip of thermistor 
c	Remove a screw on the electrical box. 	

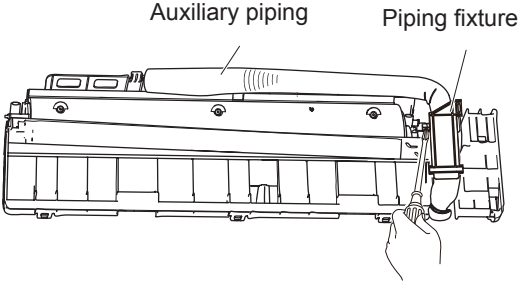
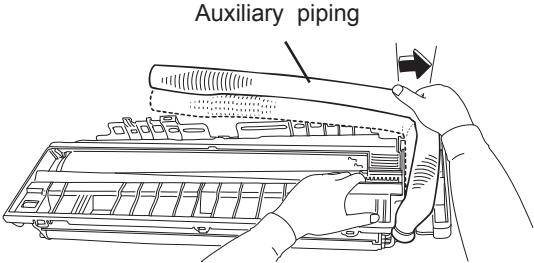
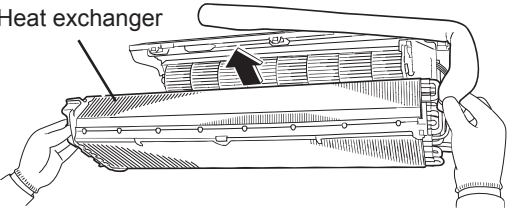
Steps	Procedure	Points
7. Remove piping fixture.		
a	<p>Remove Pipe Clamp</p> 	
b	<p>Adjust the pipeline slightly</p> 	
c	<p>Loosen the screws, in the right and the left, which fix the Evaporator Assy. Remove Evaporator Assy</p> 	

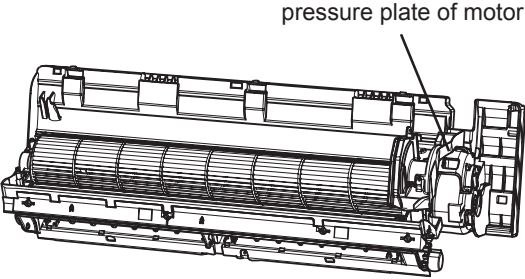
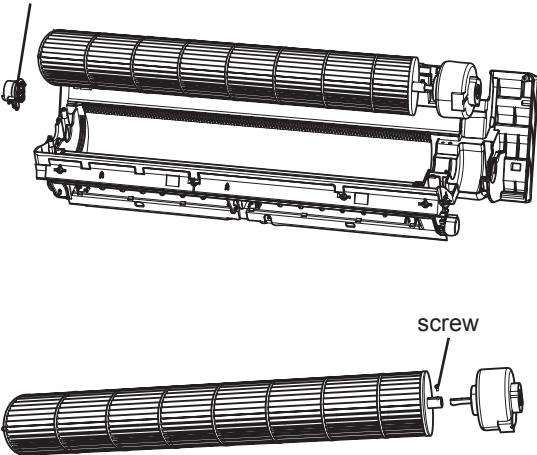
Steps	Procedure	Points
<p><b>8. Remove the pressure plate of motor</b></p>	<p>Remove screws of motor press plate and then remove the motor press plate.</p> 	
<p><b>9. Remove shaft cushion rubber base</b></p> <p>a</p> <p>b</p>	<p>Remove motor, blade and shaft cushion rubber base.</p> <p>Remove screws on cross flow blade and then remove the motor.</p> 	

## 11.2 Removal Procedure of Outdoor Unit

**!** Caution: discharge the refrigerant completely before removal.

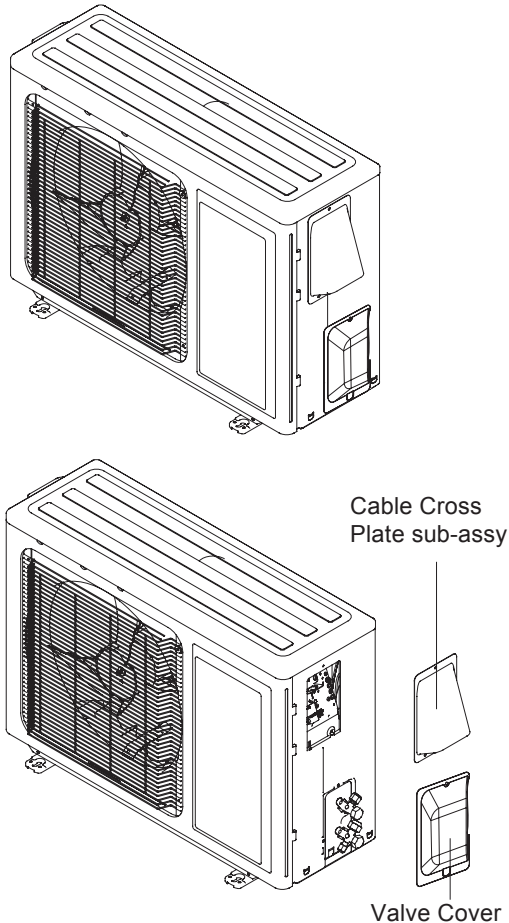
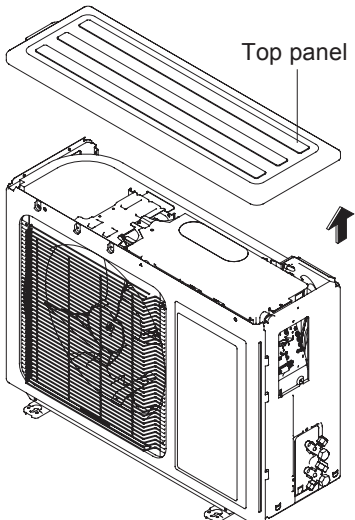
Steps	Procedure	Points
<p><b>1. Features</b></p> <p>a</p>	<p>Loosen the screw of the cable cross plate sub-assy and remove it. Pull down the stop valve cover and remove it.</p>  <p>Cable Cross Plate sub-assy</p> <p>Valve Cover</p>	
<p><b>2. Remove top panel</b></p> <p>a</p>	<p>Loosen the 3 screws (right, left) and lift the top panel.</p>  <p>Top panel</p>	

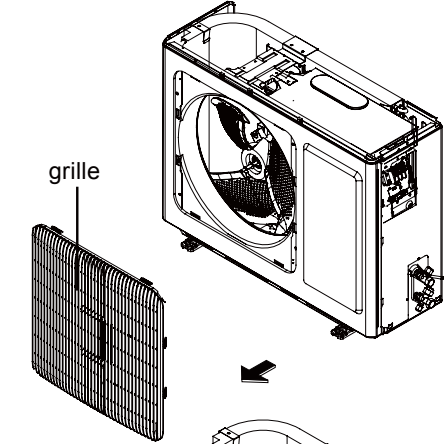
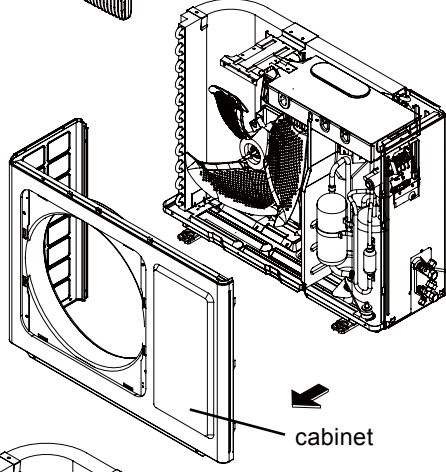
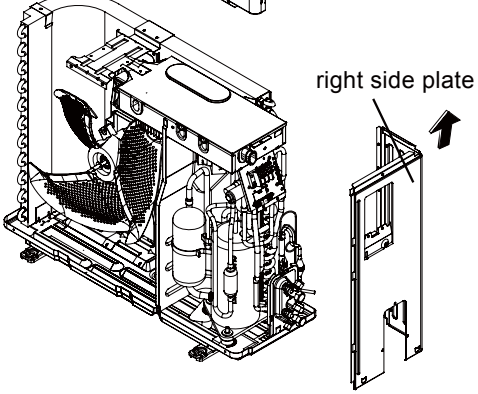
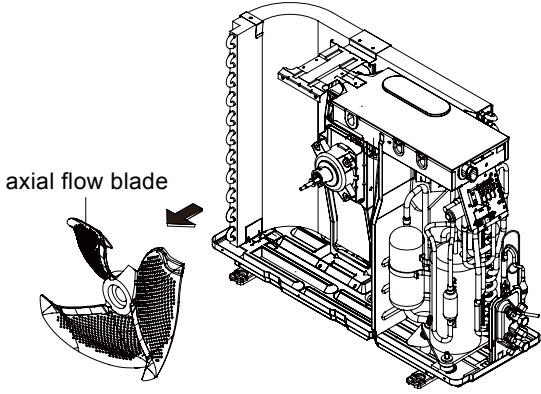
Steps	Procedure	Procedure	Points
<p>b</p>	<p>Twist off the screws connecting the grille and the panel with screwdriver and then remove the grille.</p>	 <p>grille</p>	
<p>c</p>	<p>Twist off the screws connecting the panel and the motor support, chassis and grille with screwdriver and then remove the outer case.</p>	 <p>cabinet</p>	<ul style="list-style-type: none"> <li>■ Lift the front panel and remove it while pushing the right side panel inwards. Step Procedure Points</li> </ul>
<p>d</p>	<p>Twist off the screws connecting right side plate and end plate of condenser, grille, valve support and electric box, and then remove the right side plate.</p>	 <p>right side plate</p>	
<p><b>3.Remove the fan motor</b></p>			
<p>a</p>	<p>Twist off the nut on blade with wrench and then remove the axial flow blade.</p>	 <p>axial flow blade</p>	<ul style="list-style-type: none"> <li>■ The screw has reverse winding.</li> <li>■ Remove the propeller fan.</li> </ul>

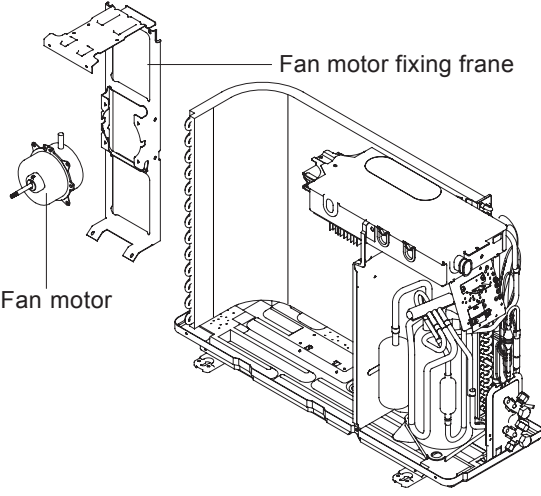
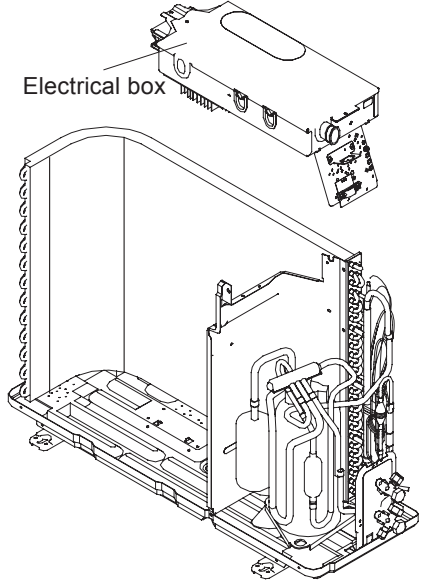
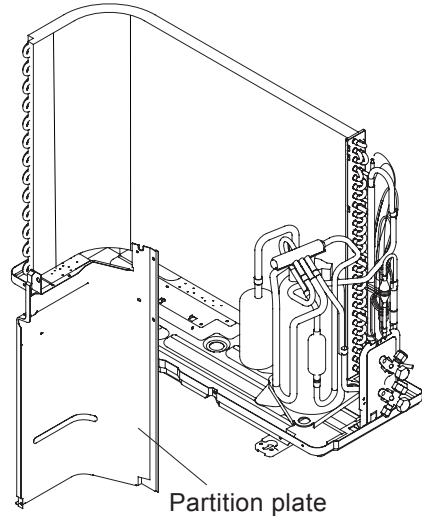
Steps	Procedure	Points
<p>b</p>	<p>Twist off the 4 tapping screws fixing the motor, pull out the pin of leading wire of motor and then remove the motor. Twist off the 2 tapping screws on motor support and 1 screws on electric box, pull it upward and then remove the motor support.</p> 	
<p><b>4.Remove the electric box.</b></p>		
	<p>Twist off the 2 screws fixing the electric box cover with screwdriver, pull it upwardly and then remove the electric box cover. Twist off the screws fixing the electric box with screwdriver, loosen the terminal, pull out the wiring terminal, pull it upward and then remove the electric box.</p> 	
<p><b>5.Remove the partition plate.</b></p>		
<p>a</p>	<p>Loosen the 2 screws.</p>	<p>■ The partition plate is fixed to the bottom frame with a hook.</p>
<p>b</p>	<p>The partition plate has a hook on the lower side. Lift and pull the partition plate to remove.</p> 	

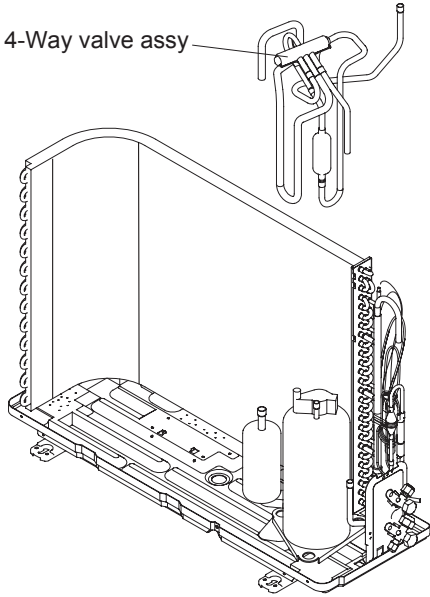
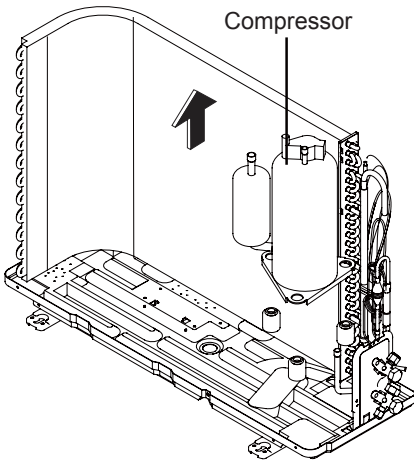
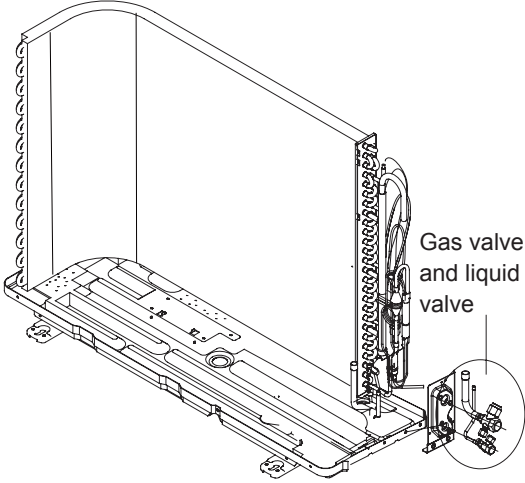
Steps	Procedure	Points
<p><b>6. Remove compressor</b></p>		
<p>a</p>	<p>Unsolder the pipeline connected to the compressor. (Release all refrigerant before disassembling the pipeline)</p>  <p>4-Way valve assy</p>	
<p>b</p>	<p>Twist off the 3 foot nuts on compressor and then remove the compressor.</p>  <p>Compressor</p>	
<p>c</p>	<p>Twist off the 2 bolts fixing the gas valve, unsolder the soldering joint between gas valve and air return pipe and then remove the gas valve. (note: When unsoldering the soldering joint, wrap the gas valve with wet cloth completely to avoid the damage to valve.) Twist off the 2 bolts fixing the liquid valve, unsolder the soldering joint between liquid valve and Y-type tube and then remove the liquid valve.</p>  <p>Gas valve and liquid valve</p>	



# Appendix:

## Appendix 1: Reference Sheet of Celsius and Fahrenheit

Conversion formula for Fahrenheit degree and Celsius degree:  $T_f = T_c \times 1.8 + 32$

Set temperature

Fahrenheit display temperature (°F)	Fahrenheit (°F)	Celsius (°C)	Fahrenheit display temperature (°F)	Fahrenheit (°F)	Celsius (°C)	Fahrenheit display temperature (°F)	Fahrenheit (°F)	Celsius (°C)
61	60.8	16	69/70	69.8	21	78/79	78.8	26
62/63	62.6	17	71/72	71.6	22	80/81	80.6	27
64/65	64.4	18	73/74	73.4	23	82/83	82.4	28
66/67	66.2	19	75/76	75.2	24	84/85	84.2	29
68	68	20	77	77	25	86	86	30

Ambient temperature

Fahrenheit display temperature (°F)	Fahrenheit (°F)	Celsius (°C)	Fahrenheit display temperature (°F)	Fahrenheit (°F)	Celsius (°C)	Fahrenheit display temperature (°F)	Fahrenheit (°F)	Celsius (°C)
32/33	32	0	55/56	55.4	13	79/80	78.8	26
34/35	33.8	1	57/58	57.2	14	81	80.6	27
36	35.6	2	59/60	59	15	82/83	82.4	28
37/38	37.4	3	61/62	60.8	16	84/85	84.2	29
39/40	39.2	4	63	62.6	17	86/87	86	30
41/42	41	5	64/65	64.4	18	88/89	87.8	31
43/44	42.8	6	66/67	66.2	19	90	89.6	32
45	44.6	7	68/69	68	20	91/92	91.4	33
46/47	46.4	8	70/71	69.8	21	93/94	93.2	34
48/49	48.2	9	72	71.6	22	95/96	95	35
50/51	50	10	73/74	73.4	23	97/98	96.8	36
52/53	51.8	11	75/76	75.2	24	99	98.6	37
54	53.6	12	77/78	77	25			

## Appendix 2: Configuration of Connection Pipe

1. Standard length of connection pipe

- 16.40ft, 24.61ft, 26.25ft.

2. Min. length of connection pipe is 9.84ft.

3. Max. length of connection pipe and max. high difference.

4. The additional refrigerant oil and refrigerant charging required after prolonging connection pipe

- After the length of connection pipe is prolonged for 32.81ft at the basis of standard length, you should add 5ml of refrigerant oil for each additional 16.40ft of connection pipe.

- The calculation method of additional refrigerant charging amount (on the basis of liquid pipe):

Cooling capacity	Max length of connection pipe	Max height difference
5000 Btu/h(1465 W)	49.21ft	16.40ft
7000 Btu/h(2051 W)	49.21ft	16.40ft
9000 Btu/h(2637 W)	49.21ft	32.81ft
12000 Btu/h(3516 W)	65.62ft	32.81ft
18000 Btu/h(5274 W)	80.02ft	32.81ft
24000 Btu/h(7032 W)	80.02ft	32.81ft
28000 Btu/h(8204 W)	98.43ft	32.81ft
36000 Btu/h(10548 W)	98.43ft	65.62ft
42000 Btu/h(12306 W)	98.43ft	65.62ft
48000 Btu/h(14064 W)	98.43ft	65.62ft

- When the length of connection pipe is above 16.40ft, add refrigerant according to the prolonged length of liquid pipe. The additional refrigerant charging amount per meter is different according to the diameter of liquid pipe. See the following sheet.

- Additional refrigerant charging amount = prolonged length of liquid pipe X additional refrigerant charging amount per meter

Additional refrigerant charging amount for R22, R407C, R410A and R134a			
Diameter of connection pipe		Outdoor unit throttle	
Liquid pipe(inch)	Gas pipe(inch)	Cooling only(oz./ft.)	Cooling and heating(oz./ft.)
Φ1/4	Φ3/8or Φ1/2	0.2	0.2
Φ1/4 or Φ3/8	Φ5/8 or Φ3/4	0.2	0.2
Φ1/2	Φ3/4 or Φ7/8	0.3	1.3
Φ5/8	Φ1 or Φ1 1/4	0.7	1.3
Φ3/4	/	2.7	2.7
Φ7/8	/	3.8	3.8

## Appendix 3: Pipe Expanding Method

**⚠ Note:**

Improper pipe expanding is the main cause of refrigerant leakage. Please expand the pipe according to the following steps:

**A: Cut the pipe**

- Confirm the pipe length according to the distance of indoor unit and outdoor unit.
- Cut the required pipe with pipe cutter.

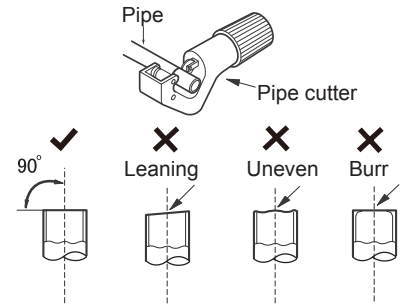

**B: Remove the burrs**

- Remove the burrs with shaper and prevent the burrs from getting into the pipe.

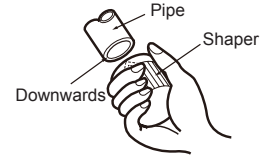

**C: Put on suitable insulating pipe**

**D: Put on the union nut**

- Remove the union nut on the indoor connection pipe and outdoor valve; install the union nut on the pipe.

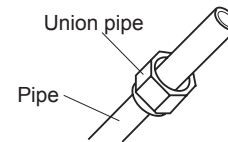

**E: Expand the port**

- Expand the port with expander.

**⚠ Note:**

- "A" is different according to the diameter, please refer to the sheet below:

Outer diameter(inch)	A(inch)	
	Max	Min
Φ1/4	2/39	1/36
Φ3/8	1/16	1/51
Φ1/2	1/14	1/51
Φ5/8	5/53	2/23

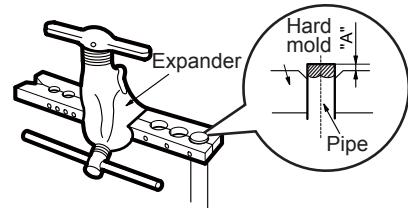

**F: Inspection**

- Check the quality of expanding port. If there is any blemish, expand the port again according to the steps above.

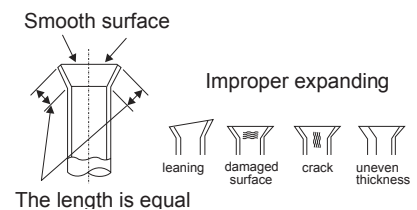

## Appendix 4: List of Resistance for Temperature Sensor

Resistance Table of Ambient Temperature Sensor for Indoor and Outdoor Units(15K)

Temp.(°F)	Resistance(kΩ)	Temp.(°F)	Resistance(kΩ)	Temp.(°F)	Resistance(kΩ)	Temp.(°F)	Resistance(kΩ)
-2.2	138.1	68	18.75	138.2	3.848	208.4	1.071
-0.4	128.6	69.8	17.93	140	3.711	210.2	1.039
1.4	121.6	71.6	17.14	141.8	3.579	212	1.009
3.2	115	73.4	16.39	143.6	3.454	213.8	0.98
5	108.7	75.2	15.68	145.4	3.333	215.6	0.952
6.8	102.9	77	15	147.2	3.217	217.4	0.925
8.6	97.4	78.8	14.36	149	3.105	219.2	0.898
10.4	92.22	80.6	13.74	150.8	2.998	221	0.873
12.2	87.35	82.4	13.16	152.6	2.896	222.8	0.848
14	82.75	84.2	12.6	154.4	2.797	224 3/5	0.825
15.8	78.43	86	12.07	156.2	2.702	226.4	0.802
17.6	74.35	87.8	11.57	158	2.611	228.2	0.779
19.4	70.5	89.6	11.09	159.8	2.523	230	0.758
21.2	66.88	91.4	10.63	161.6	2.439	231.8	0.737
23	63.46	93.2	10.2	163.4	2.358	233.6	0.717
24.8	60.23	95	9.779	165.2	2.28	235.4	0.697
26.6	57.18	96.8	9.382	167	2.206	237.2	0.678
28.4	54.31	98.6	9.003	168.8	2.133	239	0.66
30.2	51.59	100.4	8.642	170.6	2.064	240.8	0.642
32	49.02	102.2	8.297	172.4	1.997	242.6	0.625
33.8	46.6	104	7.967	174.2	1.933	244.4	0.608
35.6	44.31	105.8	7.653	176	1.871	246.2	0.592
37.4	42.14	107.6	7.352	177.8	1.811	248	0.577
39.2	40.09	109.4	7.065	179.6	1.754	249.8	0.561
41	38.15	111.2	6.791	181.4	1.699	251.6	0.547
42.8	36.32	113	6.529	183.2	1.645	253.4	0.532
44.6	34.58	114.8	6.278	185	1.594	255.2	0.519
46.4	32.94	116.6	6.038	186.8	1.544	257	0.505
48.2	31.38	118.4	5.809	188.6	1.497	258.8	0.492
50	29.9	120.2	5.589	190.4	1.451	260.6	0.48
51.8	28.51	122	5.379	192.2	1.408	262.4	0.467
53.6	27.18	123.8	5.197	194	1.363	264.2	0.456
55.4	25.92	125.6	4.986	195.8	1.322	266	0.444
57.2	24.73	127.4	4.802	197.6	1.282	267.8	0.433
59	23.6	129.2	4.625	199.4	1.244	269.6	0.422
60.8	22.53	131	4.456	201.2	1.207	271.4	0.412
62.6	21.51	132 4/5	4.294	203	1.171	273.2	0.401
64.4	20.54	134.6	4.139	204.8	1.136	275	0.391
66.2	19.63	136.4	3.99	206.6	1.103	276.8	0.382

Resistance Table of Tube Temperature Sensors for Indoor and Outdoor (20K)

Temp.(°F)	Resistance(kΩ)	Temp.(°F)	Resistance(kΩ)	Temp.(°F)	Resistance(kΩ)	Temp.(°F)	Resistance(kΩ)
-2.2	181.4	68	25.01	138.2	5.13	208.4	1.427
-0.4	171.4	69.8	23.9	140	4.948	210.2	1.386
1.4	162.1	71.6	22.85	141.8	4.773	212	1.346
3.2	153.3	73.4	21.85	143.6	4.605	213.8	1.307
5	145	75.2	20.9	145.4	4.443	215.6	1.269
6.8	137.2	77	20	147.2	4.289	217.4	1.233
8.6	129.9	78.8	19.14	149	4.14	219.2	1.198
10.4	123	80.6	18.13	150.8	3.998	221	1.164
12.2	116.5	82.4	17.55	152.6	3.861	222.8	1.131
14	110.3	84.2	16.8	154.4	3.729	224 3/5	1.099
15.8	104.6	86	16.1	156.2	3.603	226.4	1.069
17.6	99.13	87.8	15.43	158	3.481	228.2	1.039
19.4	94	89.6	14.79	159.8	3.364	230	1.01
21.2	89.17	91.4	14.18	161.6	3.252	231.8	0.983
23	84.61	93.2	13.59	163.4	3.144	233.6	0.956
24.8	80.31	95	13.04	165.2	3.04	235.4	0.93
26.6	76.24	96.8	12.51	167	2.94	237.2	0.904
28.4	72.41	98.6	12	168.8	2.844	239	0.88
30.2	68.79	100.4	11.52	170.6	2.752	240.8	0.856
32	65.37	102.2	11.06	172.4	2.663	242.6	0.833
33.8	62.13	104	10.62	174.2	2.577	244.4	0.811
35.6	59.08	105.8	10.2	176	2.495	246.2	0.77
37.4	56.19	107.6	9.803	177.8	2.415	248	0.769
39.2	53.46	109.4	9.42	179.6	2.339	249.8	0.746
41	50.87	111.2	9.054	181.4	2.265	251.6	0.729
42.8	48.42	113	8.705	183.2	2.194	253.4	0.71
44.6	46.11	114.8	8.37	185	2.125	255.2	0.692
46.4	43.92	116.6	8.051	186.8	2.059	257	0.674
48.2	41.84	118.4	7.745	188.6	1.996	258.8	0.658
50	39.87	120.2	7.453	190.4	1.934	260.6	0.64
51.8	38.01	122	7.173	192.2	1.875	262.4	0.623
53.6	36.24	123.8	6.905	194	1.818	264.2	0.607
55.4	34.57	125.6	6.648	195.8	1.736	266	0.592
57.2	32.98	127.4	6.403	197.6	1.71	267.8	0.577
59	31.47	129.2	6.167	199.4	1.658	269.6	0.563
60.8	30.04	131	5.942	201.2	1.609	271.4	0.549
62.6	28.68	132 4/5	5.726	203	1.561	273.2	0.535
64.4	27.39	134.6	5.519	204.8	1.515	275	0.521
66.2	26.17	136.4	5.32	206.6	1.47	276.8	0.509

Resistance Table of Discharge Temperature Sensor for Outdoor(50K)

Temp.(°F)	Resistance(kΩ)	Temp.(°F)	Resistance(kΩ)	Temp.(°F)	Resistance(kΩ)	Temp.(°F)	Resistance(kΩ)
-20.2	853.5	50	98	120.2	18.34	190.4	4.754
-18.4	799.8	51.8	93.42	122	17.65	192.2	4.609
-16.6	750	53.6	89.07	123.8	16.99	194	4.469
-14.8	703.8	55.4	84.95	125.6	16.36	195.8	4.334
-13	660.8	57.2	81.05	127.4	15.75	197.6	4.204
-11.2	620.8	59	77.35	129.2	15.17	199.4	4.079
-9.4	580.6	60.8	73.83	131	14.62	201.2	3.958
-7.6	548.9	62.6	70.5	132 4/5	14.09	203	3.841
-5.8	516.6	64.4	67.34	134.6	13.58	204.8	3.728
-4	486.5	66.2	64.33	136.4	13.09	206.6	3.619
-2.2	458.3	68	61.48	138.2	12.62	208.4	3.514
-0.4	432	69.8	58.77	140	12.17	210.2	3.413
1.4	407.4	71.6	56.19	141.8	11.74	212	3.315
3.2	384.5	73.4	53.74	143.6	11.32	213.8	3.22
5	362.9	75.2	51.41	145.4	10.93	215.6	3.129
6.8	342.8	77	49.19	147.2	10.54	217.4	3.04
8.6	323.9	78.8	47.08	149	10.18	219.2	2.955
10.4	306.2	80.6	45.07	150.8	9.827	221	2.872
12.2	289.6	82.4	43.16	152.6	9.489	222.8	2.792
14	274	84.2	41.34	154.4	9.165	224 3/5	2.715
15.8	259.3	86	39.61	156.2	8.854	226.4	2.64
17.6	245.6	87.8	37.96	158	8.555	228.2	2.568
19.4	232.6	89.6	36.38	159.8	8.268	230	2.498
21.2	220.5	91.4	34.88	161.6	7.991	231.8	2.431
23	209	93.2	33.45	163.4	7.726	233.6	2.365
24.8	198.3	95	32.09	165.2	7.47	235.4	2.302
26.6	199.1	96.8	30.79	167	7.224	237.2	2.241
28.4	178.5	98.6	29.54	168.8	6.998	239	2.182
30.2	169.5	100.4	28.36	170.6	6.761	240.8	2.124
32	161	102.2	27.23	172.4	6.542	242.6	2.069
33.8	153	104	26.15	174.2	6.331	244.4	2.015
35.6	145.4	105.8	25.11	176	6.129	246.2	1.963
37.4	138.3	107.6	24.13	177.8	5.933	248	1.912
39.2	131.5	109.4	23.19	179.6	5.746	249.8	1.863
41	125.1	111.2	22.29	181.4	5.565	251.6	1.816
42.8	119.1	113	21.43	183.2	5.39	253.4	1.77
44.6	113.4	114.8	20.6	185	5.222	255.2	1.725
46.4	108	116.6	19.81	186.8	5.06	257	1.682
48.2	102.8	118.4	19.06	188.6	4.904	258.8	1.64



F R I E D R I C H

JF00302172