

LIEBHERR

Use and Care Manual

Refrigerator with BioFresh
compartment, built-in

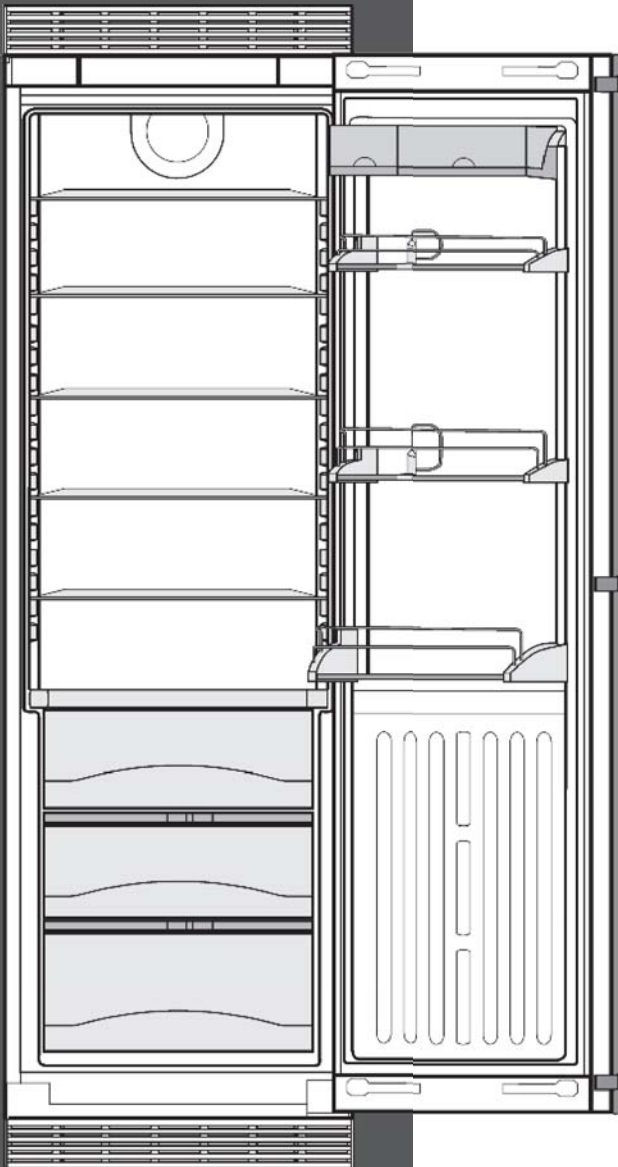

RB1410 RBI1410
040614 7085302 - 01

The appliance at a glance

Contents

1	The appliance at a glance.....	2
1.1	Additional benefits.....	2
1.2	Overview of the appliance and its equipment...	3
1.3	Range of appliance use.....	3
1.4	Conformity.....	3
1.5	Energy saving.....	4
1.6	Example of food arrangement.....	4
2	General safety information.....	4
3	Controls and displays.....	5
3.1	Operating and control elements.....	5
3.2	Temperature display.....	5
4	Start-up.....	5
4.1	Transporting the appliance.....	5
4.2	Setting up the appliance.....	6
4.3	Disposal of packaging.....	6
4.4	Connecting the appliance.....	7
4.5	Switching on the appliance.....	7
5	Operation.....	7
5.1	Temperature display unit.....	7
5.2	Brightness of the temperature display.....	7
5.3	Child-proof lock.....	8
5.4	Door alarm.....	8
5.5	Sabbath Mode.....	8
5.6	Fridge compartment.....	9
5.7	BioFresh compartment.....	11
6	Maintenance.....	13
6.1	Thawing.....	13
6.2	Cleaning the appliance.....	13
6.3	Customer service.....	14
6.4	Appliance Information.....	14
7	Troubleshooting.....	14
8	Putting appliance out of service.....	16
8.1	Vacation Tips.....	16
8.2	Switching off the appliance.....	16
8.3	Decommissioning	16
9	Disposing of the appliance.....	17
10	Liebherr Warranty Plan.....	17

Congratulations on the purchase of your new appliance. With this purchase, you have chosen all the advantages of the latest refrigeration technology, guaranteeing you a high-quality appliance with a long life span and high operating safety.

The equipment of your appliance gives you the highest level of day-to-day ease of operation.

Together we are making an active contribution to the conservation of our environment by purchasing this appliance which is manufactured in an environmentally friendly process with the use of recyclable materials.

We hope you enjoy your new appliance.

The manufacturer is constantly working to improve all models. Therefore please understand that we reserve the

right to make design, equipment and technical modifications.

To get to know all the benefits of your new appliance, please read the information contained in these instructions carefully.

The instructions apply to several models, so there may be differences. Sections which only apply to certain appliances are indicated with an asterisk (*).

Instructions for action are marked with a ►, the results of action are marked with a ▷.

1 The appliance at a glance

1.1 Additional benefits

- CFC free
- Energy-optimized refrigerant circuit
- Energy-efficient insulation
- Low energy consumption
- User-friendly electronic controls
- Active function indicators
- Temperature can be controlled in the appliance independent of ambient conditions according to its climate rating - Temperature can be displayed as °C or °F
- The appliance defrosts automatically - no need to spend time defrosting
- Large refrigeration capacity
- Safety glass storage shelves
- Adjustable door shelves for tall bottles
- Bright LED interior light
- Door ajar alarm
- Integrated transport grips on appliance housing
- Transport castors at back
- Easy to clean
- Door hinges can be reversed
- Soft stop mechanisms
- This unit is certified as Sabbath compliant by the Star-K organization thus allowing the appliance to be used during religious holidays. For more information please visit Star-K on the web at www.star-k.org.



1.2 Overview of the appliance and its equipment

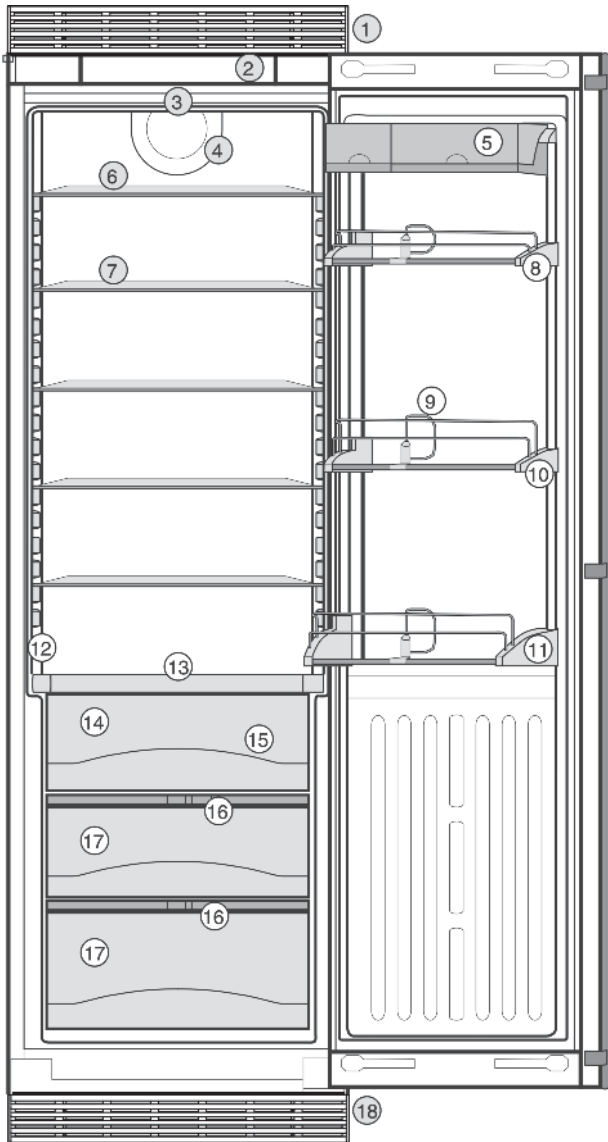

Fig. 1

- | | |
|------------------------------------|---|
| (1) Rear transport handles | (10) Door rack for bottles |
| (2) Operating and control elements | (11) Gallon capacity rack |
| (3) Interior light | (12) Rating plate |
| (4) Fan | (13) Bottle shelf |
| (5) Container shelf, removable | (14) BioFresh compartment, Drysafe |
| (6) Shelf, adjustable | (15) Drain hole |
| (7) Shelf, can be split | (16) Hydrosafe controls |
| (8) Door rack, adjustable | (17) BioFresh compartment, Hydrosafe |
| (9) Bottle holder, adjustable | (18) Adjustable feet, front transport handles, rear transport castors |

1.3 Range of appliance use

Normal use

The appliance is only suitable for refrigerating food in a domestic environment or an environment that is similar to a domestic one. This includes, for example, use

- in staff kitchens, bed and breakfast establishments,
- by guests in country homes, hotels, motels and other types of accommodations,
- for catering and similar wholesale services.

Use the appliance only for normal household purposes. All other types of uses are not permitted.

Foreseeable misuse

The following uses are specifically prohibited:

- Storage and cooling of medication, blood plasma, laboratory preparations or similar substances and products in accordance with the CMDCAS and FDA 510(k)
- Use in areas at risk of explosion

Incorrect appliance use can cause damage to the stored products or cause them to spoil.

Climate ratings

The appliance is set to operate within specific ambient temperature limits according to its climate rating. The climate rating for your appliance is printed on the rating plate.

Note

- Compliance with the specified ambient temperatures is required, otherwise the refrigeration performance is reduced.

Climate rating	for ambient temperatures from
SN	50 °F (10 °C) to 90 °F (32 °C)
N	61 °F (16 °C) to 90 °F (32 °C)
ST	61 °F (16 °C) to 101 °F (38 °C)
T	61 °F (16 °C) to 110 °F (43 °C)

1.4 Conformity

The refrigerant circuit has been tested for leaks. The appliance complies with the relevant safety regulations and the directives UL250 and CAN/CSA C22.2 No.63-93. BioFresh meets EN ISO 8561 requirements for a chill compartment.

Instructions for testing institutes:

General safety information

Tests must be carried out in accordance with the applicable standards and guidelines.

The preparation and testing of the appliance must be carried out taking account of **the manufacturer's loading plans** and the **instructions in the operating manual**.

1.5 Energy saving

- Always ensure good ventilation. Do not obstruct ventilation openings or grilles.
- Do not install the appliance in direct sunlight or next to an oven, heater, or similar heat source.
- Energy consumption depends on installation conditions such as the ambient temperature (see 1.3).
- Avoid opening the appliance door for any longer than necessary.
- The lower the temperature is set the higher the energy consumption.
- All food stored in the appliance should be well wrapped and covered. This prevents frost buildup.
- Only take food out for as long as necessary so that it does not get too warm.
- Storing hot food: let it cool to room temperature first.

1.6 Example of food arrangement

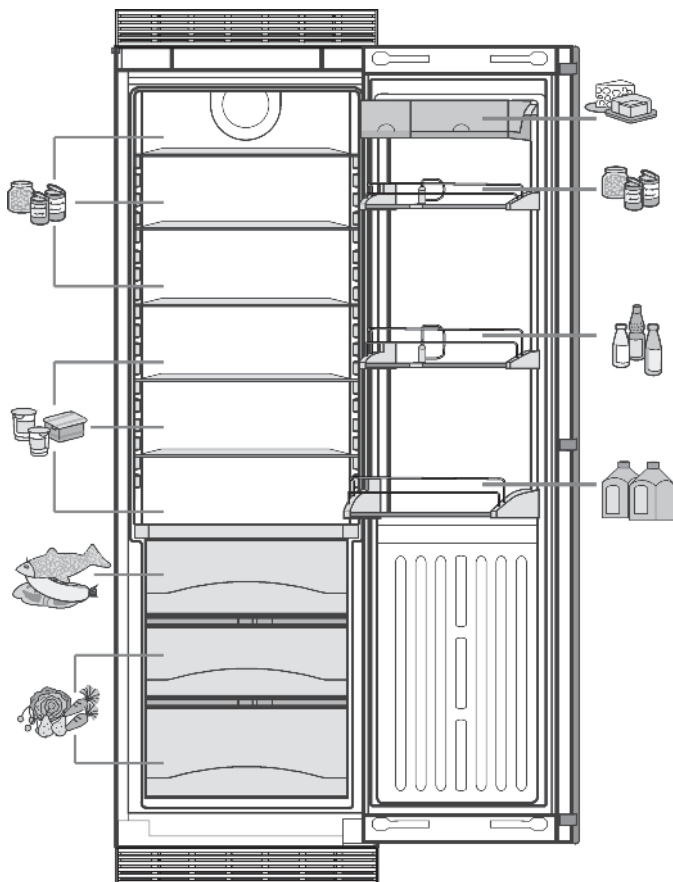

Fig. 2

2 General safety information

Read and follow these instructions. They contain safety advice which is important for safe and problem-free installation and operation. Always read and follow the safety advice.

Dangers for the user:

- This appliance can be operated by children 8 years and older as well as by persons with reduced physical, sensory or mental capabilities or lack of experience and knowledge if they are supervised or have been instructed in the safe use of the appliance and understand the associated risks. Children must not play with the appliance. Cleaning and user maintenance must not be performed by children unless they are supervised.
- When disconnecting the appliance from the outlet, always take hold of the plug. Do not pull on the cable.
- Disconnect the power plug or switch off the power if a fault occurs.
- Do not damage the mains power line. Do not operate the appliance from a defective mains power line.
- Repairs, work on the appliance and replacement of the power cord should only be carried out by the customer service department.
- The appliance should only be assembled, connected and disposed of in accordance with the instructions.
- Only install, connect and dispose of the appliance in accordance with the instructions.
- Only operate the appliance after it has been installed.
- Please keep the instructions and pass them on to any future owner.

Risk of fire:

- Do not operate the appliance near explosive gases.
- Do not store explosive materials or spray cans with flammable propellants, such as e.g. butane, propane, pentane, etc. in the appliance. You can recognize such spray cans by the printed contents or a flame symbol. Any leaking gasses can be ignited by electrical components.
- Keep burning candles, lamps and other objects with open flames away from the appliance so that they do not set it on fire.

- Alcoholic beverages or other containers holding alcohol must always be tightly sealed for storage purposes. Any leaking alcohol can be ignited by electrical components

Tipover hazard:

- Do not stand or climb on the base, drawers, doors, etc. This applies in particular to children.

Risk of food poisoning:

- Do not consume food that has passed its best before date.

Danger of frostbite, feelings of numbness and pain:

- Avoid continued skin contact with the cold surfaces or chilled/frozen food or adopt protective measures, e. g. use gloves. Do not consume ice cream (especially sherbets) and ice cubes immediately when they are too cold.

Risk of injury and damage:

- Hot steam may lead to injuries. Do not use any electrical heating or steam cleaning equipment, naked flames or defrosting sprays for defrosting
- Do not remove ice with sharp objects

Risk of crushing

- Do not reach into the soft stop mechanism. Fingers may be trapped when the door is closed.

Follow the specific instructions in the other sections:

	DANGER	indicates a hazardous situation, which if not avoided, will result in death or serious injury.
	WARNING	indicates a hazardous situation, which if not avoided, could result in death or serious injury.
	CAUTION	indicates a hazardous situation, which if not avoided, will result in minor or moderate injury.
	NOTICE	indicates a hazardous situation, which if not avoided, could result in damage to property.
	Note	indicates useful advice and tips.

3 Controls and displays

3.1 Operating and control elements

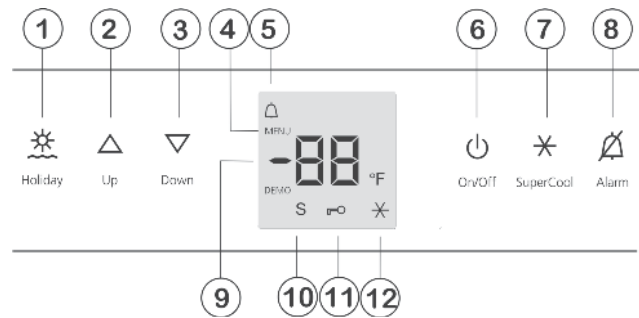

Fig. 3

- (1) Holiday button
- (2) Up button
- (3) Down button
- (4) Menu symbol
- (5) Alarm symbol
- (6) On/Off button
- (7) SuperCool button
- (8) Alarm button
- (9) Temperature display
- (10) Sabbath Mode symbol
- (11) Child safety symbol
- (12) SuperCool symbol

The exact contact point is between the symbol and its label

3.2 Temperature display

The following is displayed in normal operation:

- the average fridge temperature

The following displays indicate malfunction. Possible causes and corrective actions: (see Troubleshooting).

- F0 through F9

4 Start-up

4.1 Transporting the appliance



CAUTION

Risk of injury or damage if incorrectly transported.

- ▶ Transport the appliance in its packaging.
- ▶ Transport the appliance upright.
- ▶ Do not move the appliance on your own.

Start-up

4.2 Setting up the appliance



WARNING

Risk of fire due to moisture!

If live parts or the power cord get wet, this can cause a short circuit.

- ▶ The appliance is designed for use in enclosed spaces. Do not operate the appliance in open space or in damp areas or where there is spray.
- ▶ Only operate the appliance after it has been installed.



WARNING

Risk of fire due to short circuit.

If the power cable or plug of the appliance or another appliance and the back of the appliance touch each other the power cable or plug will be damaged by the vibrations of the appliance which could lead to a short circuit.

- ▶ Install the appliance so that it does not touch any plugs or power cables.
- ▶ Do not connect the appliance or other appliances to the sockets on the back of the appliance.



WARNING

Danger of fire and damage!

- ▶ Do not place devices that give off heat, e.g. microwaves, toasters, etc. on the appliance.



CAUTION

Risk of personal injury!

- ▶ Have two people move this appliance into place.

NOTICE

Risk of damage caused by condensation

Installing the appliance next to any other refrigerator or freezer can cause condensation or damage to the Liebherr appliance.

- ▶ Do not install this appliance next to any other refrigerator or freezer except another Liebherr model. Liebherr models are designed to allow side-by-side installation. They are equipped with a heating system to eliminate condensation when refrigerators or freezers are installed side-by-side.

NOTICE

Risk of damage for the finished floor surface!

- ▶ Protect the finished floor surface before you uncrate the unit.

Verify that:

- The floor under the appliance is flat and level.
- The floor can support the appliance's weight plus approximately 1200 pounds (544 kg) of food weight.

- The appliance is not placed in direct sunlight or near the stove, range top, radiators and similar heat sources.
- The kitchen cabinet that the appliance is installed in is shimmed to the floor level if the floor heights are not equal.
- Cutout dimensions are accurate.
- Electrical outlet is in correct location.
- The air flow is not restricted. Air flow must be provided for the appliance to operate properly. The factory air vents provide 31 square inches (200 cm²) of air flow per appliance. If you are replacing the air vents with an overlay, the air flow must be the same or greater than the factory air vents.
- ▶ Examine the unit and packaging for shipping damage. Contact the carrier immediately if you suspect there is any damage.
- ▶ Note the type (model, number), index, appliance/serial number, date of purchase and where purchased (see 6.4) .
- ▶ Remove anything attached to the rear or side walls of appliance that would prevent proper installation or impede proper ventilation.
- ▶ Remove the protective film from the outside of the appliance.

Note

- ▶ Clean the appliance (see 6.2) .

If the appliance is set up in humid areas, condensation may build on the outside of the appliance.

- ▶ Always ensure proper ventilation.
- ▶ Assemble appliances according to separate installation instructions.

4.3 Disposal of packaging



WARNING

Danger of suffocation from packaging materials and films!

- ▶ Do not allow children to play with packaging materials.

The packaging is made from recyclable materials:

- Corrugated card/cardboard
- Parts made of foamed polystyrene
- Films and bags from polyethylene
- Packing bands from polypropylene
- Wood frame nailed together with a polyethylene window*

- ▶ Take the packaging material to an official collection point.



4.4 Connecting the appliance



WARNING

Electrical shock hazard!

- ▶ Start-up should only take place once the appliance has been installed according to these instructions.
- ▶ Electrically ground appliance.
- ▶ Do not ground to a gas pipe.
- ▶ Check with a qualified electrician if you are not sure the appliance is properly grounded.
- ▶ Do not have a fuse in the neutral or grounding circuit.
- ▶ Do not use an extension cord, power bar or a multiple socket adapter.
- ▶ Do not use a power cord that is frayed or damaged.



WARNING

Electrical shock hazard!

This appliance is equipped with a three-prong (grounding) polarized plug for your protection against possible shock hazards. Electrical Grounding Required.

- ▶ Do not remove the round grounding prong from the plug.
- ▶ Use only an grounded adapter.

- Wait 1 hour after installation before you plug in the appliance. This allows the refrigerant and system lubrication to reach equilibrium.
- Make sure incoming voltage is the same as the appliance rating. A 110-120 Volt, 60 Hz, 15 Amp electrical supply (20 Amp for side-by-side installations) circuit that is controlled by a circuit breaker or fuse is required.
- We recommend using a dedicated circuit for this appliance to prevent electrical overload.
- Follow all Federal, State and local electrical, fire and building codes and ordinances when installing the receptacle and / or the appliance.
- In some communities, a wall switch is required to turn power to the appliance ON and OFF.
- To reduce the risk of fire, electric shock, or personal injury, installation work and electrical wiring must be done by a qualified electrician in accordance with all applicable codes and standards, including fire-rated construction.
- The Power Plug must be easily accessible so that the appliance can be disconnected from the mains quickly in an emergency. It must not be behind the back of the appliance.
- The top of the electric outlet must be located within 82-5/8 in. (2100 mm) from the top of the base in the cabinet.

4.5 Switching on the appliance



- ▶ Open the door.
- ▶ Press On/Off button *Fig. 3 (6)*.
- ▷ The temperature display indicates the current temperature.
- ▷ The interior light comes on when the door is opened.
- ▷ Whenever “DEMO” appears on the display, the appliance is running in demonstration mode. Contact the customer service department.

5 Operation

5.1 Temperature display unit

The temperature display can be changed from °F to °C.

5.1.1 To change the unit

- ▶ Activate setting mode: Press SuperCool button *Fig. 3 (7)* for about 5 seconds.
- ▷ The SuperCool button *Fig. 3 (7)* will flash.
- ▷ **5** is displayed in the temperature display.
- ▶ Using Up button *Fig. 3 (2)*/ Down button *Fig. 3 (3)* select °.
- ▶ To confirm: Briefly press SuperCool button *Fig. 3 (7)*.
- ▶ Using Up button *Fig. 3 (2)*/ Down button *Fig. 3 (3)* select °F or °C.
- ▶ To confirm: Briefly press SuperCool button *Fig. 3 (7)*.
- ▶ To exit setting mode: Press On/Off button *Fig. 3 (6)*.



-or-

- ▶ Wait 5 minutes.
- ▷ The temperature is again displayed in the temperature display.

5.2 Brightness of the temperature display

You can adapt the brightness of the temperature display to the light conditions in the room in which it is installed.

5.2.1 Setting the brightness

The brightness can be set between **h0** (no luminosity) and **h5** (maximum luminosity).

- ▶ To activate setting mode: Press SuperCool button *Fig. 3 (7)* for about 5 seconds.
- ▷ **5** is shown on the display.
- ▷ The Menu symbol *Fig. 3 (4)* lights up.
- ▶ Using Up button *Fig. 3 (2)* or Down button *Fig. 3 (3)* select **h**.
- ▶ To confirm: Briefly press SuperCool button *Fig. 3 (7)*.
- ▶ To set the display brighter: Press Up button *Fig. 3 (2)*.
- ▶ To set the display darker: Press Down button *Fig. 3 (3)*.
- ▶ To confirm: Press SuperCool button *Fig. 3 (7)*.
- ▷ The brightness is set to the new value.

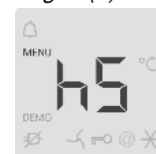

Operation

► To deactivate setting mode: Press On/Off button *Fig. 3 (6)*.

-or-

► Wait 5 minutes.

▷ The temperature is again displayed in the temperature display.

5.3 Child-proof lock

You can use the child-proof lock to lock the buttons. This means that children cannot accidentally switch off the appliance when playing.



5.3.1 Switching on the child proof lock

► Select setting mode: Press and hold the SuperCool button *Fig. 3 (7)* for approx. 5 seconds.

▷ 5 will appear on the display.

▷ The Menu symbol *Fig. 3 (4)* lights up.

► Using the Up *Fig. 3 (2)* or Down button *Fig. 3 (3)*, select **c**.

► Press the SuperCool button *Fig. 3 (7)* briefly to confirm. When **c1** is shown on the display:

► To switch on the child proof lock, press the SuperCool button *Fig. 3 (7)* briefly.



▷ The Child safety symbol *Fig. 3 (11)* lights up. **c** flashes on the display.

When **c0** is shown on the display:

► To switch the child proof lock off, press the SuperCool button *Fig. 3 (7)* briefly.

▷ The Child safety symbol *Fig. 3 (11)* goes out. **c** flashes on the display.

► To deactivate setting mode: Press the On/Off button *Fig. 3 (6)*.

-or-

► Wait 5 min.

▷ The temperature is again displayed on the temperature display.

5.4 Door alarm

If the door is open for longer than 180 seconds, the acoustic warning sounds.

The acoustic warning stops automatically when the door is closed.



5.4.1 Switching off the door alarm

The acoustic warning can be switched off when the door is open. The acoustic warning remains switched off as long as the door is open. When the door is closed, the alarm function is active again.

► Press Alarm button *Fig. 3 (8)*.

▷ The door alarm stops.

5.5 Sabbath Mode

After entering Sabbath Mode, you do not have to worry about lights, digits, icons, tones, alarms or fans. The defrost cycle operates solely on clock time without any feedback from usage of the refrigerator. After a power failure, the appliance will return to Sabbath Mode without requiring additional input.



WARNING

Danger of food poisoning!

No record will be kept of a power failure during Sabbath Mode. Thus, during Sabbath mode, if a power failure occurs that you are not aware of, when the power comes back on, the unit will continue to be in Sabbath Mode but when Sabbath Mode is ended there will be no indication that a power failure occurred.

If a power failure occurs during Sabbath mode:

► Check the quality of the food. Do not consume spoiled food!

- No control operations are possible other than switching off Sabbath Mode.

- If the unit is currently running in a mode such as Superfrost, Supercool or the Ventilation is enabled these functions will continue and finish their timed cycles independent of now being in Sabbath mode.

- No audible signals are emitted, and the temperature display does not indicate any warnings or settings (such as a temperature alarm or door alarm).

- Light does not operate.

5.5.1 Setting Sabbath mode

► To activate setting mode: Press and hold the SuperCool button *Fig. 3 (7)* for approx. 5 s.

▷ 5 flashes on the display.

▷ The Menu symbol *Fig. 3 (4)* lights up.

► To access the Sabbath mode function: Briefly press the SuperCool button *Fig. 3 (7)*.

When **51** is shown on the display:

► **To turn on** Sabbath mode, briefly press the SuperCool button *Fig. 3 (7)*.

When **50** is shown on the display:

► **To turn off** Sabbath mode, briefly press the SuperCool button *Fig. 3 (7)*.



► To deactivate setting mode: Press the On/Off button *Fig. 3 (6)*.

-or-

► Wait 5 min.

▷ The Sabbath Mode symbol *Fig. 3 (10)* appears on the temperature display as long as Sabbath Mode is active.

▷ Sabbath mode switches off automatically after 120 hours if it is not manually switched off beforehand.

5.6 Fridge compartment

The natural circulation of air in the refrigerator compartment results in zones differing in temperature. It is coldest directly above the plate separating off the BioFresh zone and at the rear wall. It is warmest at the top front of the compartment and in the door.

5.6.1 Refrigerating food

Note

- ▶ Do not load the door with more than 50 lbs (22.6 kg) of food.

Note

Insufficient ventilation results in an increase in energy consumption and reduction of the refrigerating performance.

- ▶ Never block the air slits in the fan.
- ▶ Use recyclable plastic, metal, aluminum and glass containers and cling film to wrap foods.
- ▶ Always use closed containers for liquids and for food that may give off or be tainted by odor or flavor transfer or cover them.
- ▶ Foods which give off a large amount of ethylene gas and those that are sensitive to this gas, such as fruit, vegetables and salad, should always be separated or wrapped so as not to reduce the storage life; for example, do not store tomatoes together with kiwi fruits or cabbage.
- ▶ Use the front floor area of the fridge compartment only to set down food to be refrigerated temporarily, e.g., when rearranging or sorting the contents of the fridge. Do not leave the food there, as it may be pushed back or tipped over when the door is closed.
- ▶ Do not store food too close together to enable sufficient air circulation.
- ▶ To ensure bottles do not tip over: move the bottle holder.

At the base of the fridge compartment, either the integrated bottle shelf or the glass shelf can be used:

- ▶ To use the bottle shelf: store the glass shelf under the bottle shelf to save space.
- ▶ Place bottles with the base pointing backwards facing the rear wall. If the bottles project beyond the front of the bottle shelf:
- ▶ Set the bottom storage rack in the door one position higher.

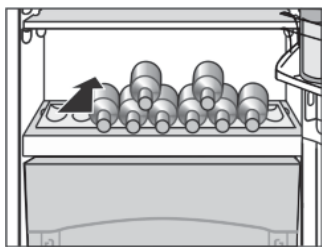

- the type, temperature and amount of food.

The temperature can be set from 37 °F (3 °C) to 48 °F (9 °C), 41 °F (5 °C) is recommended.

- ▶ To set a higher temperature: press the Up button *Fig. 3 (2)*.
- ▶ To set a lower temperature: press the Down button *Fig. 3 (3)*.
- ▷ When pressed once the previously set temperature display value will flash.
- ▶ To change the temperature in 1 °F (1 °C) increments: briefly press the button.
- ▶ To change the temperature continuously: hold the button down.
- ▷ The value is displayed flashing during the setting operation.
- ▷ The actual temperature is displayed about 5 seconds after the last press of a button. The temperature slowly adjusts to the new value.

5.6.3 SuperCool

With SuperCool you switch to the highest cooling performance to reach lower cooling temperatures. Use SuperCool to rapidly cool large quantities of food.



SuperCool will use more energy than normal operation.

Cooling with SuperCool

- ▶ Briefly press the SuperCool button *Fig. 3 (7)*.
- ▷ The SuperCool symbol *Fig. 3 (12)* lights up in the display.
- ▷ The cooling temperature drops to the coldest value. SuperCool is switched on.
- ▷ SuperCool automatically switches itself off after about 6-12 hours. The appliance returns to work in the energy-saving normal mode.

To prematurely switch off SuperCool

- ▶ Briefly press the SuperCool button *Fig. 3 (7)*.
- ▷ The SuperCool symbol *Fig. 3 (12)* goes out in the display.
- ▷ SuperCool is switched off.

5.6.4 Holiday setting

The holiday setting saves energy and stops smells building up when the refrigerator section door remains closed for a long time.



The freezer section continues to operate when the appliance is set to the holiday setting.

Switching the holiday setting on

- ▶ Remove all food from the refrigerator and BioFresh compartment because it will go off otherwise.
- ▶ Press the Holiday button *Fig. 3 (1)* for 3 seconds.

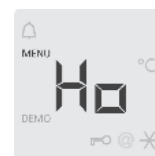

- ▷ The holiday setting is switched on. **Ho** appears on the display.

5.6.2 Setting the temperature

The temperature depends on the following factors:

- the number of times the door is opened
- the room temperature of the installation location

Operation

Switching the holiday setting off

- ▶ Press the Holiday button *Fig. 3 (1)*.
- ▷ The holiday setting is switched off.
- ▷ The displays shows the current cooling temperature.

5.6.5 Shelves

Shifting or removing shelves



CAUTION

- Danger of lacerations!
The storage shelf can shatter if dropped or mishandled. You could cut yourself on the pieces of broken glass.
- ▶ Only remove storage shelves when there is nothing on them.

Extension stops secure the shelves against being accidentally pulled out.

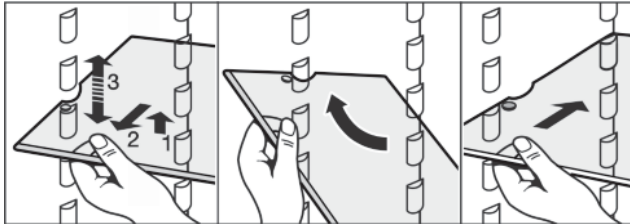
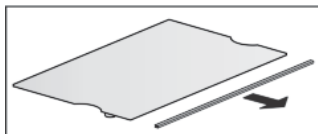

Fig. 4

- ▶ Lift up the shelf and pull it slightly forward.
- ▶ Adjust the shelf height by shifting the spacers in the runners.
- ▶ Insert the short shelf at the height of the gallon capacity rack so that door closes properly. It is supported on support bars.
- ▶ To remove the shelf completely, set it at an angle and pull it out towards you.
- ▶ Push the shelf back in at the desired height. The removal stops must point downwards and be positioned behind the front contact surface.

To dismantle shelves

- ▶ The shelves can be dismantled for cleaning.



5.6.6 Using the split shelf



CAUTION

- Danger of lacerations!
The storage shelf can shatter if dropped or mishandled. You could cut yourself on the pieces of broken glass.
- ▶ Only remove storage shelves when there is nothing on them.

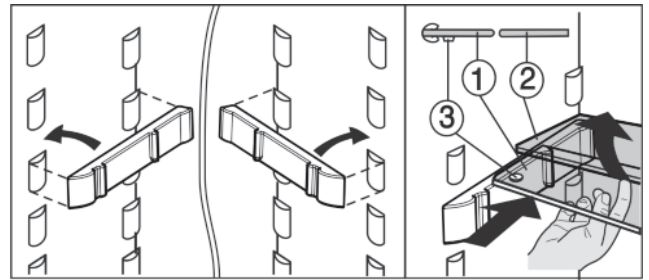

Fig. 5

- ▶ The glass plate (1) with the pull out stops must be at the front so that the stops (3) point downward.

5.6.7 Door racks

Note

- ▶ Do not load the door with more than 50 lbs (22.6 kg) of food.

Repositioning the door racks

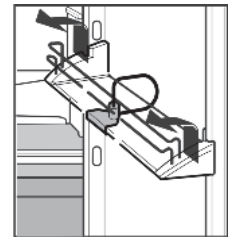

- ▶ Push rack up, pull forward, and reinsert in the reverse order.

The container trays can be removed and placed on the table as a unit.

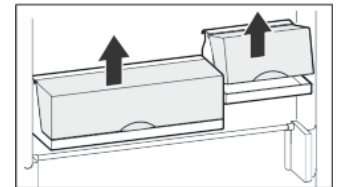

Instead of one wide container and one small container, a special set containing three small containers is available from Customer Service.

It is possible to use one or both boxes. If unusually tall bottles are to be stored, only suspend one box above the bottle rack.

- ▶ To swap containers: pull up to remove and reinsert in the desired position.

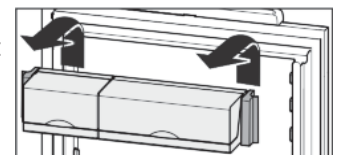

To dismantle door racks

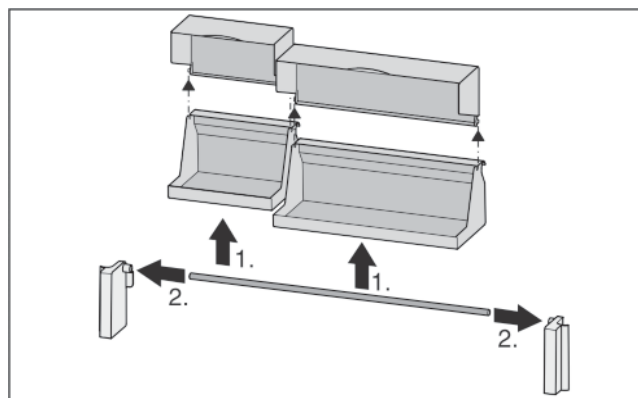
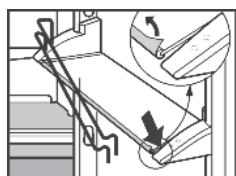

Fig. 6



- ▶ The door racks can be dismantled for cleaning.

5.6.8 Removing the bottle holder

- ▶ Always take hold of the bottle holder by the plastic part.

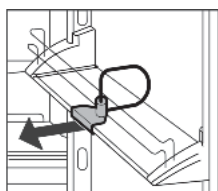

5.7 BioFresh compartment

The BioFresh compartment allows you to store certain fresh foods up to three times longer compared to conventional refrigeration systems, without sacrificing quality.

Food with a “use by” date must still be consumed by the date indicated on the package.

The taste, freshness, and nutritional value (vitamin B and C groups) of the food are preserved to a large extent. Fruit and vegetables spoil less quickly and lose less water, and food remains fresher and more wholesome.

5.7.1 HydroSafe

On the humid setting, the HydroSafe is suitable for storing loose-leaf lettuce, vegetables, and fruit with a high moisture content. When the drawer is full, this creates a cool, fresh environment with an air humidity of up to 90%. The humidity level in the compartment depends on the moisture content of the food inside and on how often the compartment is opened. You can adjust the humidity yourself.

5.7.2 DrySafe

The DrySafe is suitable for storing dry or packaged food (such as dairy products, meat, fish, and sausage). The DrySafe provides a relatively dry storage environment.

5.7.3 Storing food

Note

- ▶ Do not store vegetables that do not support cold temperatures (such as cucumbers, eggplant, semi-ripe tomatoes, zucchini, and all cold-sensitive exotic fruits) in the BioFresh compartment.

The fresher the product and the better the quality, the longer it can be stored.

- ▶ When shopping, make sure the food you purchase is fresh.
- ▶ To prevent spoilage due to the transfer of bacteria: Store unpackaged animal products and plant-based products in separate compartments. This also applies for different types of meat. If you must store food together to save space:
 - ▶ Keep the food packaged.

5.7.4 Storage times

Guidelines for storage at low humidity			
Butter	up to	90	days
Hard cheese	up to	110	days
Milk	up to	12	days
Sausage, cold cuts	up to	9	days
Poultry	up to	6	days
Pork	up to	7	days
Beef	up to	7	days
Game	up to	7	days

Note

- ▶ Note that higher-protein foods spoil more quickly. This means that shellfish and crustaceans spoil more quickly than fish, and fish spoils more quickly than meat.

Guidelines for storage at high humidity			
Vegetables, lettuce			
Artichokes	up to	14	days
Celery	up to	28	days
Cauliflower	up to	21	days
Broccoli	up to	13	days
Endives	up to	27	days
Mâche	up to	19	days
Peas	up to	14	days
Kale	up to	14	days

Operation

Guidelines for storage at high humidity			
Carrots	up to	80	days
Garlic	up to	160	days
Kohlrabi	up to	55	days
Iceberg lettuce	up to	13	days
Herbs	up to	13	days
Leeks	up to	29	days
Mushrooms	up to	7	days
Radishes	up to	10	days
Brussels sprouts	up to	20	days
Asparagus	up to	18	days
Spinach	up to	13	days
Savoy cabbage	up to	20	days
Fruit			
Apricots	up to	13	days
Apples	up to	80	days
Pears	up to	55	days
Blackberries	up to	3	days
Dates	up to	180	days
Strawberries	up to	7	days
Figs	up to	7	days
Blueberries	up to	9	days
Raspberries	up to	3	days
Red currants	up to	7	days
Cherries, sweet	up to	14	days
Kiwi	up to	80	days
Peaches	up to	13	days
Plums	up to	20	days
Cranberries	up to	60	days
Rhubarb	up to	13	days
Gooseberries	up to	13	days
Grapes	up to	29	days

5.7.5 Setting the temperature in the BioFresh compartment

The temperature is controlled automatically. If the temperature in the fridge section is 39 °F (5 °C) the temperature in the BioFresh section is between 32 °F (0 °C) and 37 °F (3 °C).



You can set a slightly higher or lower temperature. The temperature can be adjusted between **b1** (coldest temperature) and **b9** (warmest temperature). The default setting is **b5**. If you select a setting between **b1** and **b4**, the temperature can fall below 32 °F (0 °C), and the food can freeze slightly as a result.

- ▶ To activate setting mode: Press and hold the SuperCool button *Fig. 3 (7)* for approx. 5 s.
- ▷ The Menu symbol *Fig. 3 (4)* lights up. **5** is displayed on the temperature display.
- ▶ Keep pressing the Up button *Fig. 3 (2)* until **b** flashes on the display.
- ▶ To confirm: Briefly press the SuperCool button *Fig. 3 (7)*.
- ▶ To set a higher temperature: Press the Up button *Fig. 3 (2)*.
- ▶ To set a lower temperature: Press the Down button *Fig. 3 (3)*.
- ▶ To confirm: Press the SuperCool button *Fig. 3 (7)*.
- ▷ The temperature slowly adjusts to the new value.



- ▶ To deactivate setting mode: Press the On/Off button *Fig. 3 (6)*.
- or-
- ▶ Wait 5 mins.
- ▷ The temperature is again displayed on the temperature display.

5.7.6 Adjusting the humidity in the Hydro-Safe

- ▶  Low humidity: Move the slide control to the left.
- ▶  High humidity: Move the slide control to the right.



5.7.7 Drawers

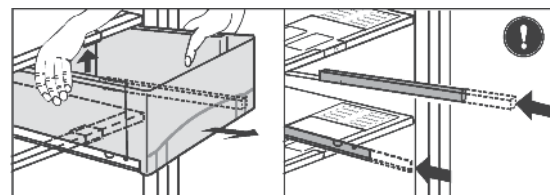

Fig. 7

- ▶ Pull the drawer out, lift the back, and pull forward to remove.
- ▶ Slide the rails back in!

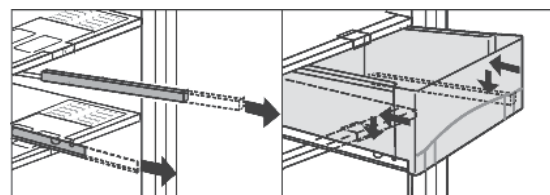

Fig. 8

- ▶ Pull the rails out.
- ▶ Place the drawer on the rails and slide it all the way in until you hear it snap into place.

5.7.8 Humidity control plate

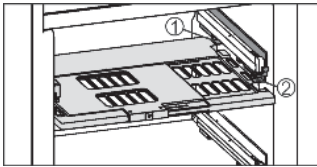

Fig. 9

- ▶ To remove the humidity control plate: After removing the drawers, carefully pull the plate forward and down to remove.
- ▶ To insert the humidity control plate: Insert the guide pieces of the plate into the rear retainer Fig. 9 (1) from below, then snap the plate into the retainer Fig. 9 (2) in the front.

6 Maintenance

6.1 Thawing

6.1.1 Defrosting the refrigerator

The fridge compartment defrosts automatically. The defrosted water will evaporate. Drops of water on the back wall are a functional feature; this is completely normal.

- ▶ Clean the drain opening regularly so that the condensation water can drain away. (see 6.2)

6.2 Cleaning the appliance



WARNING

Danger of electric shock.

- ▶ Unplug refrigerator or disconnect power.



WARNING

Risk of injury or damage due to hot steam.

Hot steam can cause scalding/burns and damage to surfaces.

- ▶ Do not use steam cleaners.

NOTICE

Incorrect cleaning damages the appliance.

- ▶ Do not use concentrated cleaning agents.
- ▶ Do not use steel wool or sponges that scour or scratch.
- ▶ Do not use caustic or abrasive cleaning materials or those containing sand, chloride, chemicals or acids.
- ▶ Do not use chemical solvents.
- ▶ Do not damage or remove the rating plate on the inside of the appliance. It is vital for the customer service department.
- ▶ Do not pull off, kink or damage any cables or other components.
- ▶ Do not let cleaning water get into the drain gutter, the ventilation grille and electrical parts.
- ▶ Use soft cleaning cloths and a multi-purpose cleaning agent with a neutral pH value.
- ▶ Only use food-compatible cleaning and care agents inside the appliance.

- ▶ **Empty the appliance.**

- ▶ **Disconnect the power plug.**



- ▶ Clean the **plastic surfaces, outside and inside**, by hand using lukewarm water and a little dish washing liquid.

Stainless steel which is exposed to chlorine gas or dampness may become discolored. This is normal. If your appliance is exposed to chlorine gas or dampness, clean and polish it more frequently. If there are any signs of rust or discoloration, clean and polish the appliance as soon as possible.*

Do not apply stainless steel cleaning agents to glass or plastic surfaces so as not to scratch them. Initially darker areas and quite an intensive color of the stainless steel surfaces are normal.*

- ▶ If dirty clean **external stainless steel surfaces** with a commercially available stainless steel cleaning agent. Then apply the supplied stainless steel cleaning agent evenly in the direction of the grain.*

- ▶ To clean the **drain opening**: Remove deposits with a thin instrument, e.g. a cotton bud.

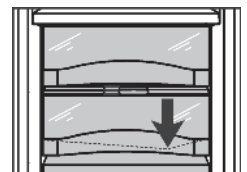

- ▶ Most of the **equipment parts** can be dismantled for cleaning: see the respective chapter.
- ▶ Clean **fittings** by hand using lukewarm water and a little dish washing liquid.
- ▶ Clean the **telescopic rails** with a damp cloth only. The grease in the tracks is for lubrication purposes and should not be removed.

After cleaning:

- ▶ Wipe the appliance and accessories dry.
- ▶ Connect the appliance and switch it on again.
- ▶ Put the food back in the appliance.

Troubleshooting

6.3 Customer service

First check whether you can remedy the fault yourself (see Troubleshooting). If this is not the case, please contact a qualified service provider.



WARNING

Risk of injury from repairs by non-professionals.

► Repairs and work on the appliance and the power supply cable not described in the Manual (see Maintenance) should only be carried out by a qualified service provider.

► Read the appliance designation

Fig. 10 (1), service no. *Fig. 10 (2)* and serial no. *Fig. 10 (3)* from the rating plate. The rating plate is located inside the appliance on the left-hand side.

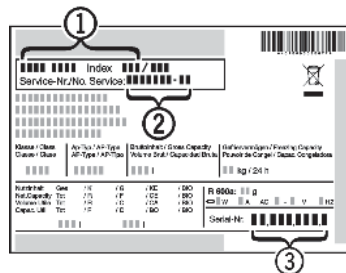

Fig. 10

► Notify a qualified service provider, specifying the fault, appliance designation *Fig. 10 (1)*, service no. *Fig. 10 (2)* and serial *Fig. 10 (3)* no.

▷ This will help us to provide you with a faster and more accurate service.

- Keep the appliance closed until the Customer Service engineer arrives.
- ▷ The food will stay cool longer.
- Disconnect the power plug (do not pull on the power cord to do this) or switch off the fuse.

6.4 Appliance Information

Make a note of this information when the appliance is installed:

Type Designation: _____
 Service Number: _____
 Appliance / Serial Number: _____
 Date of purchase: _____
 Where purchased: _____



7 Troubleshooting

Your appliance is designed and manufactured for reliable operation and a long lifespan. If a malfunction nonetheless occurs during operation, please determine if the malfunction is due to an operating error. If a service call determines operator error, you will be charged for the costs incurred, even during the warranty period. You may be able to rectify the following problems yourself:

Problem	Possible Cause	Correction
The appliance does not work.	The appliance is not switched on.	► Switch on the appliance.
	The power plug is not properly inserted in the wall socket.	► Check the power plug.
	The fuse in the wall socket is not OK.	► Check the fuse.
	Power failure	► Keep the appliance closed. ► Protect the food: place dry ice on top of the food or use an alternate freezer, if the power failure persists for some time. ► Do not re-freeze defrosted food.
The compressor runs for a long time.	When less refrigeration is required, the speed-controlled compressor switches to a low speed. Although the running time is increased as a result, energy is saved.	► This is normal in energy-saving models.
	SuperCool function is activated.	► The compressor runs long to rapidly cool food. This is normal.
A LED at the lower rear of the appliance (for the compressor) flashes regularly	The inverter is equipped with a diagnostic LED.	► The flashing is normal.

Problem	Possible Cause	Correction
every 15 seconds*.		
Noises are too loud.	The different speed levels of speed-controlled* compressors can cause them to generate various noises during operation.	▶ These noises are normal.
A gurgling sound	This sound comes from the refrigerant flowing in the refrigeration circuit.	▶ The sound is normal.
A faint clicking sound	The sound always occurs when the refrigeration unit (the motor) automatically switches on or off.	▶ The sound is normal.
A hum. It is briefly a little louder when the refrigeration unit (the motor) switches on.	The refrigeration increases automatically when the SuperCool function is activated, fresh food has just been placed in the appliance or the door has been left open for a while.	▶ The sound is normal.
	The ambient temperature is too high.	▶ Solution: (see 1.3)
A low hum	The sound occurs as a result of fan air flow.	▶ The sound is normal.
Vibration noise	The appliance is not standing firmly on the floor. As a result, adjoining units or objects are set into vibration by the running refrigeration unit.	▶ Check the installation and, if necessary, re-align the appliance. ▶ Move bottles and containers apart.
Flow noise on the soft stop mechanism.	The sound is caused by the soft stop mechanism.	▶ The sound is normal.
The temperature display indicates: F0 to F9.	There is a fault.	▶ Contact the customer service department (see Maintenance).
The temperature display shows a flashing power failure symbol  . The warmest temperature reached during the power failure is displayed in the temperature display.	The freezer temperature rose too high during the last hours or days due to power failure or power interruption. When the power interruption is over, the appliance will continue to operate at the last temperature setting.	▶ To delete the display of the warmest temperature: Press the Alarm button <i>Fig. 3 (8)</i> . ▶ Check the quality of the food. Do not consume spoiled food. Do not re-freeze defrosted food.
DEMO lights up in the temperature display.	The demo mode is activated.	▶ Contact the customer service department (see Maintenance).
	The heat of the refrigerant circuit is used to prevent condensate from forming.	▶ This is normal.

Putting appliance out of service

Problem	Possible Cause	Correction
The outside surfaces of the appliance are hot*.		
The temperature is not cold enough.	The door of the appliance is not closed properly.	▶ Close the appliance door.
	Insufficient ventilation.	▶ Clear ventilation grilles.
	The ambient temperature is too high.	▶ Solution: (see 1.3)
	The appliance was opened too frequently or for too long.	▶ Wait to see whether the required temperature resets itself by itself. If not, contact the customer service department (see Maintenance).
	The temperature is incorrectly set.	▶ Set to a colder temperature and check after 24 hours
	The appliance is too near to a heat source (stove, heater etc).	▶ Change location of appliance or the heat source.
The interior light is not on.	The appliance is not switched on.	▶ Switch on the appliance.
	The door was open for longer than 15 minutes.	▶ The interior light automatically switches itself off if the door has been open for about 15 minutes.
	The LED interior light is faulty or the cover is damaged	<p> WARNING Risk of injury from electrical shock. Live parts are under the cover. ▶ The LED interior light should only be replaced or repaired by the Customer Service department or by engineers trained to do so.</p> <hr/> <p> WARNING Risk of injury from LED lamp! The lighting intensity of the LED light complies with laser class 1/1M. If the cover is faulty: ▶ Do not gaze directly at this lighting unit with optical lenses while very close to the light source. This can cause damage to your eyes.</p>

8 Putting appliance out of service

8.1 Vacation Tips

Short vacations: If you will be away for less than four weeks

- ▶ Use all perishables.

Long vacations: If you will be away for a month or more

- ▶ Remove all food from the appliance.
- ▶ Turn OFF the appliance.
- ▶ Clean the appliance (see 6.2) .
- ▶ Leave the door open to prevent unpleasant odors.

- ▷ This will also keep mold from building up.

8.2 Switching off the appliance

- ▶ Press and hold down the On/Off button *Fig. 3 (6)* for approx. 2 seconds.
- ▷ The temperature display is dark.
- ▷ If the device does not switch off, the child safety feature is enabled (see 5.3) .



8.3 Decommissioning

- ▶ Empty the appliance.

- ▶ Disconnect the power plug.
- ▶ Clean the appliance (see 6.2) .



- ▶ Leave the door open to prevent bad smells.

9 Disposing of the appliance

Follow the local regulations for the disposal of appliances. Old appliances can be dangerous. Contact the local refuse collection department for additional information.



DANGER

There is a risk of suffocation.

Children playing can shut themselves in and suffocate.

- ▶ Take the door(s) off.
- ▶ Remove the drawers.
- ▶ Leave the storage shelves in the appliance so that children cannot easily climb into the appliance.



WARNING

Danger of electric shock.

- ▶ Cut off the plug from the power cord and discard.
- ▶ Cut off the power cord from the discarded appliance. Dispose of separately from the appliance.

Ensure during and after disposal that the appliance isn't stored in the vicinity of gasoline or other flammable vapors and liquids.

When disposing of the appliance, ensure that the refrigeration circuit is not damaged to prevent uncontrolled escape of the refrigerant it contains (data on type plate) and oil.

10 Liebherr Warranty Plan

FULL TWO YEAR WARRANTY - For two years from the date of original purchase, your Liebherr warranty covers all parts and labor to repair or replace any part of the product which proves to be defective in materials or workmanship.

FULL FIVE YEAR WARRANTY - For five years from the date of original purchase, your Liebherr warranty covers all parts and labor to repair or replace any components that prove to be defective in materials or workmanship in the sealed system. The "Sealed System" means only the compressor, condenser, evaporator, drier and all connecting tubing.

LIMITED 6TH THROUGH 12TH YEAR WARRANTY - From the 6th through 12th year from the date of original purchase, your Liebherr warranty covers all parts that prove to be defective in materials or workmanship in the Sealed System (parts only).

TERMS APPLICABLE TO EACH WARRANTY

All service provided by Liebherr under the warranty must be performed by authorized Liebherr service representatives, unless otherwise specified by Liebherr. Service will

be provided in the home during normal business hours. This warranty applies only to products installed for normal residential use. Details regarding a non-residential warranty are available on request.

The warranty applies only to products installed in any one of the fifty states of the United States or the District of Columbia. The warranty does not cover any parts or labor to correct any defect caused by negligence, accident or improper use, maintenance, installation, service or repair, including but not limited to improper removal and reinstallation of the condensing unit.

THE WARRANTIES DESCRIBED ABOVE ARE MADE EXPRESSLY IN LIEU OF ANY OTHER WARRANTIES, EXPRESSED OR IMPLIED, INCLUDING ANY IMPLIED WARRANTY OF MERCHANTABILITY OR FITNESS FOR A PARTICULAR PURPOSE, AND OF ANY OTHER OBLIGATION OR LIABILITY ON THE PART OF LIEBHERR. IN NO EVENT SHALL LIEBHERR BE LIABLE FOR SPECIAL, INCIDENTAL OR CONSEQUENTIAL DAMAGES ARISING FROM THE BREACH OF THESE WARRANTIES OR ANY OTHER WARRANTIES, WHETHER EXPRESS, IMPLIED OR STATUTORY.

Some states do not allow the exclusion or limitation of incidental or consequential damages so the above limitation or exclusion may not apply to you. This warranty gives you specific legal rights and you may also have other legal rights which vary from state to state.

To receive parts and/or service and the name of the Liebherr authorized service representative nearest you, contact your Liebherr dealer or distributor or contact the Liebherr designated national service provider:

in the US: Service-appliances.us@liebherr.com or call 1-866-LIEBHER (1-866-543-2437).

in Canada: www.euro-parts.ca or call 1-888-LIEBHER (1-888-543-2437).

For Service in the U.S.:

Liebherr Service Center

Toll Free: 1-866-LIEBHER or 1-866-543-2437

Service-appliances.us@liebherr.com
PlusOne Solutions, Inc.
3501 Quadrangle Blvd, Suite 120
Orlando, FL 32817

For Service in Canada:

Liebherr Service Center

Toll Free: 1-888-LIEBHER or 1-888-543-2437

www.euro-parts.ca
EURO-PARTS CANADA
39822 Belgrave Road
Belgrave, Ontario, N0G 1E0
Phone: (519) 357-3320
Fax: (519) 357-1326

www.liebherr-appliances.com