

PLAN VIEW

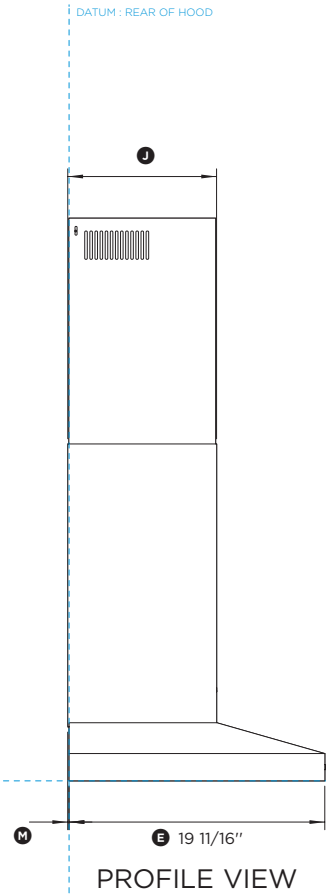

PROFILE VIEW

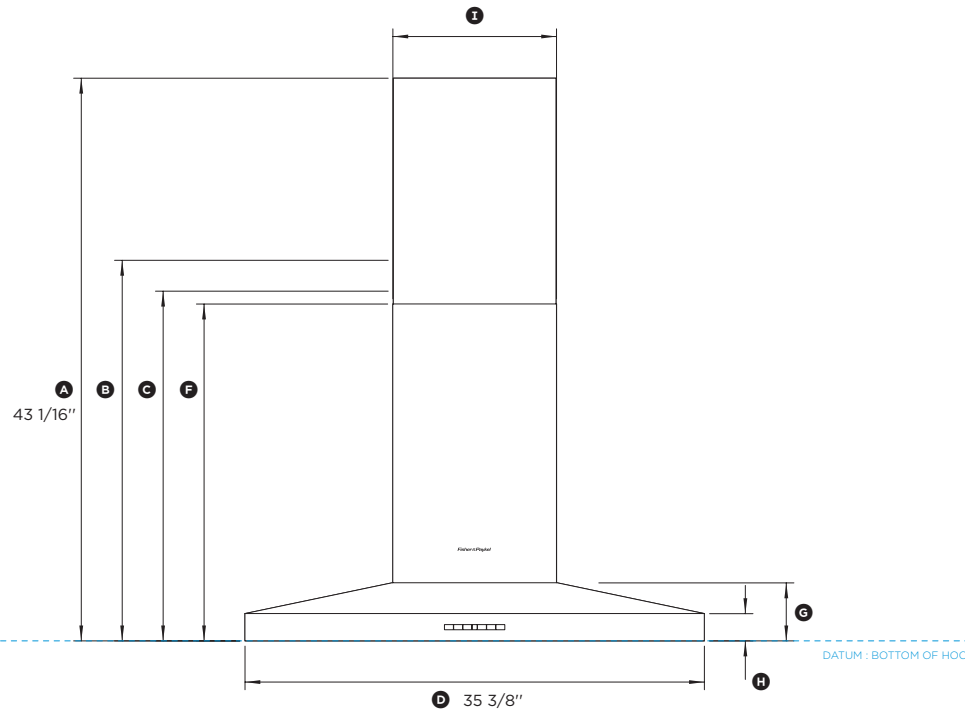

FRONT VIEW

Model no:  
**HC36PHTX1**

Product Dimensions	in
Ⓐ Maximum height of rangehood	43 1/16"
Ⓑ Minimum overall height - recirculating	29 1/8"
Ⓒ Minimum overall height - ducted	26 3/4"
Ⓓ Overall width of rangehood	35 3/8"
Ⓔ Depth of rangehood chassis	19 11/16"
Ⓕ Height from bottom datum to top of lower chimney section	25 13/16"
Ⓖ Height of canopy	4 1/2"
Ⓗ Height of control panel	2 1/16"
Ⓘ Width of chimney	12 5/8"
Ⓛ Depth of chimney including rear bracket	11 7/16"
Ⓚ Ducting outlet diameter	6"
Ⓛ Distance from center of ducting outlet to rear datum	3 3/4"
Ⓜ Rear bracket depth	1/8"

INDICATES PRODUCT DATUM -----

DATE: 10.12.2015

IMPORTANT NOTE: Throughout this guide, dimensions may vary by ±2mm (3/32"). Please read the installation manual for detailed information on installing the product. For full installation instructions & specifications visit [fisherpaykel.com](http://fisherpaykel.com)

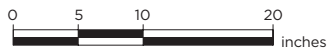

Model no:  
**HC36PHTX1**

Product Dimensions	in
Ⓐ Overall width of rangehood	35 3/8"
Ⓑ Depth of rangehood chassis	19 11/16"
Ⓒ Distance between light centers	16 1/4"
Ⓓ Distance from center of lights to rear of chassis	1 5/8"
Ⓔ Rear bracket depth	1/8"

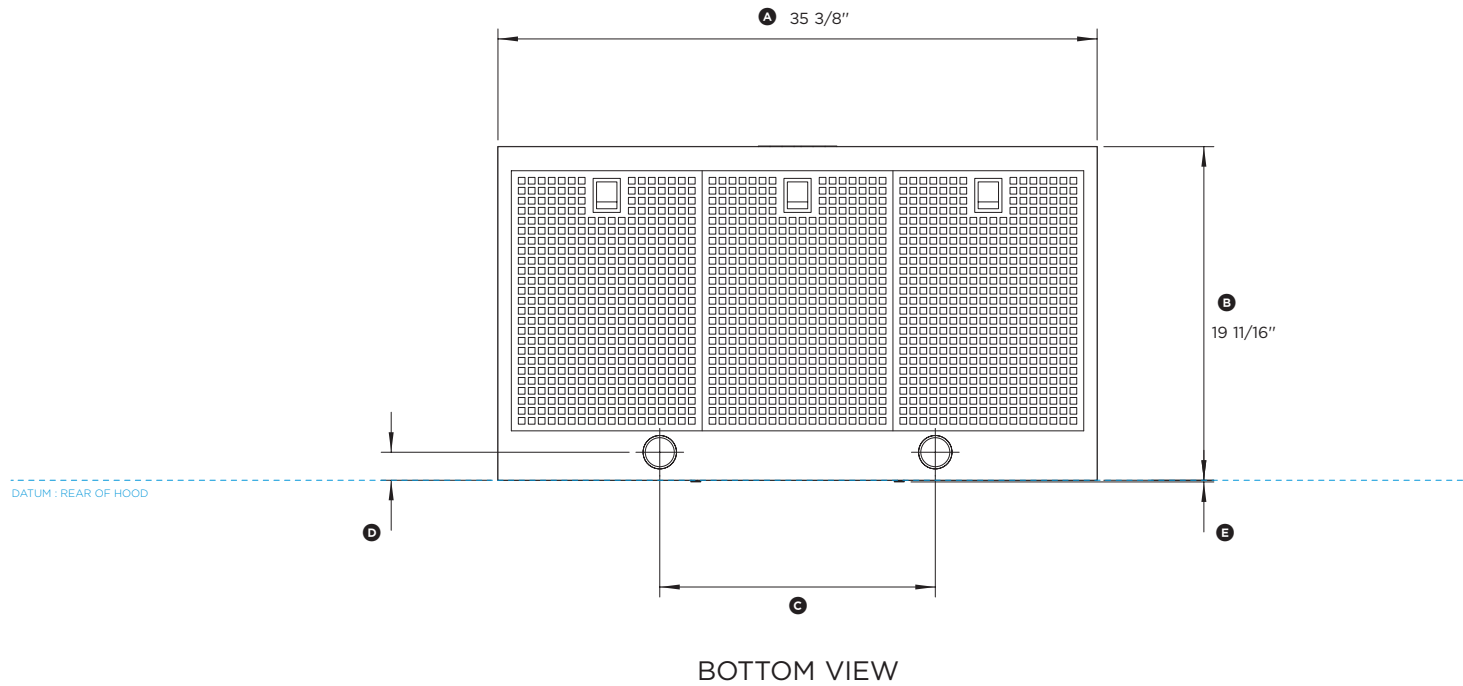

DATUM: REAR OF HOOD

INDICATES PRODUCT DATUM -----

DATE: 10.12.2015

IMPORTANT NOTE: Throughout this guide, dimensions may vary by ±2mm (3/32"). Please read the installation manual for detailed information on installing the product. For full installation instructions & specifications visit [fisherpaykel.com](http://fisherpaykel.com)

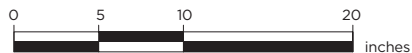

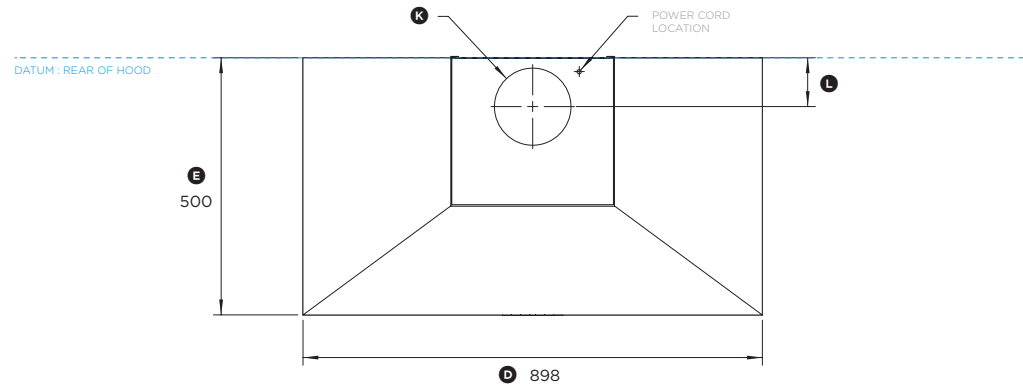

PLAN VIEW

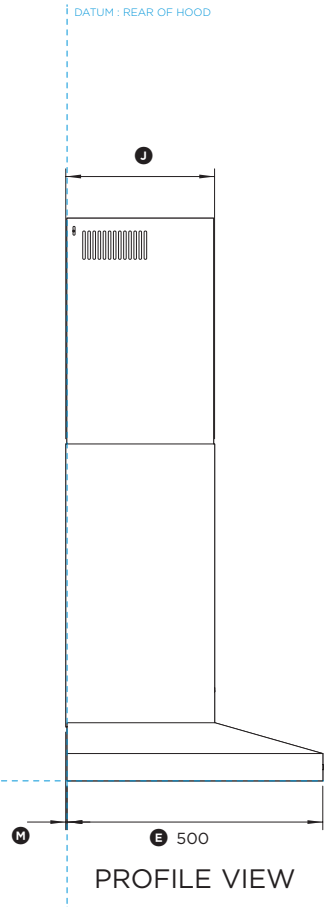

PROFILE VIEW

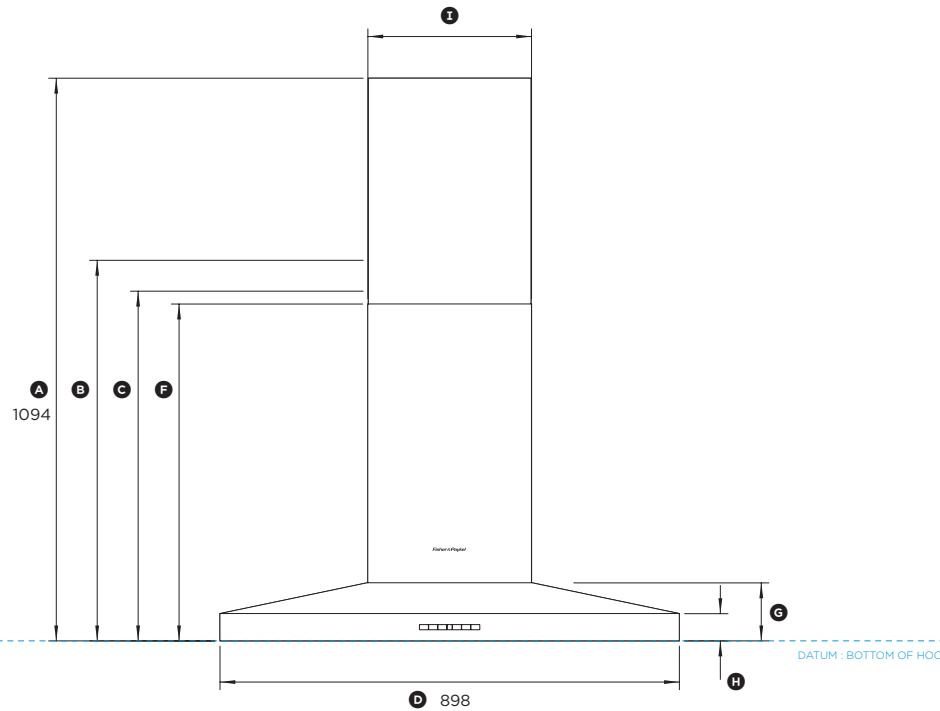

FRONT VIEW

Model no:  
**HC36PHTX1**

Product Dimensions	mm
Ⓐ Maximum height of rangehood	1094
Ⓑ Minimum overall height - recirculating	740
Ⓒ Minimum overall height - ducted	680
Ⓓ Overall width of rangehood	898
Ⓔ Depth of rangehood chassis	500
Ⓕ Height from bottom datum to top of lower chimney section	655
Ⓖ Height of canopy	114
Ⓗ Height of control panel	53
Ⓙ Width of chimney	320
Ⓚ Depth of chimney including rear bracket	290
Ⓛ Ducting outlet diameter	150
Ⓜ Distance from centre of ducting outlet to rear datum	95
Ⓝ Rear bracket depth	3

INDICATES PRODUCT DATUM -----

DATE: 10.12.2015

IMPORTANT NOTE: Throughout this guide, dimensions may vary by ±2mm (3/32"). Please read the installation manual for detailed information on installing the product. For full installation instructions & specifications visit [fisherpaykel.com](http://fisherpaykel.com)



Model no:

HC36PHTX1

Product Dimensions	mm
Ⓐ Overall width of rangehood	898
Ⓑ Depth of rangehood chassis	500
Ⓒ Distance between light centres	413
Ⓓ Distance from centre of lights to rear of chassis	42
Ⓔ Rear bracket depth	3

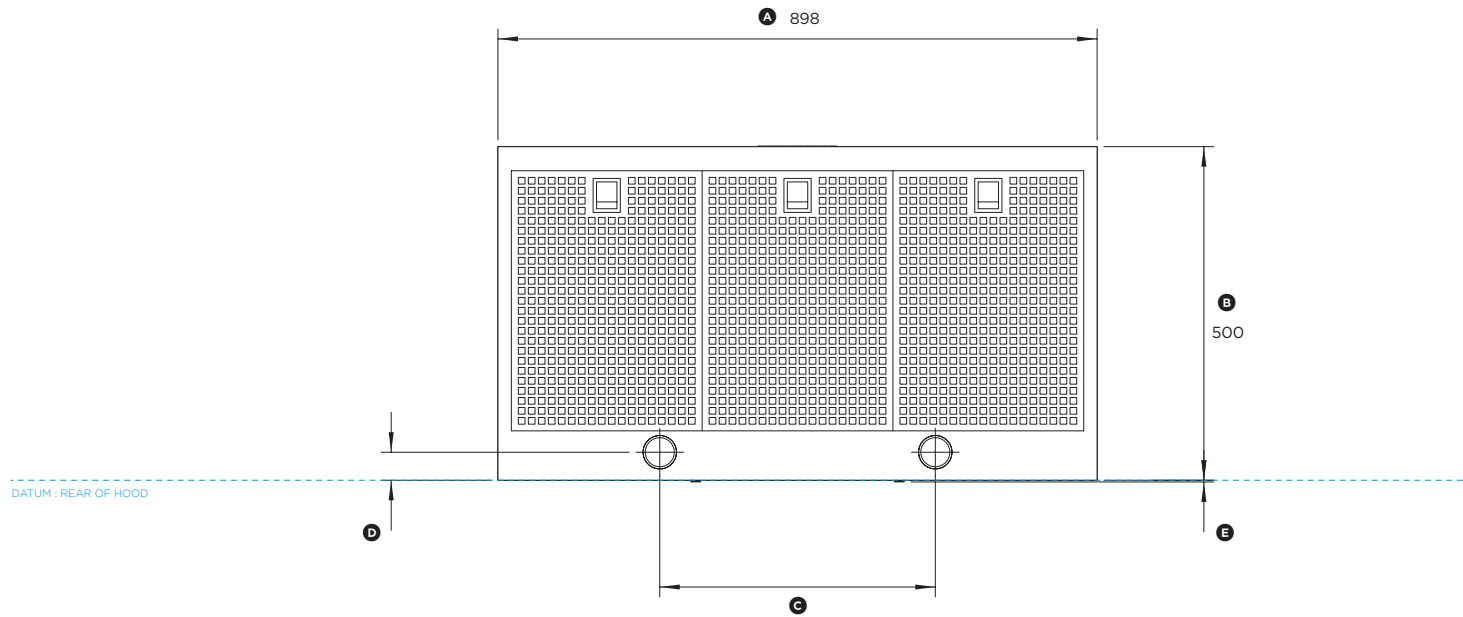

BOTTOM VIEW

INDICATES PRODUCT DATUM -----

DATE: 10.12.2015

IMPORTANT NOTE: Throughout this guide, dimensions may vary by  $\pm 2\text{mm}$  ( $3/32''$ ). Please read the installation manual for detailed information on installing the product. For full installation instructions & specifications visit [fisherpaykel.com](http://fisherpaykel.com)

