



LG OLED TV

THE ULTIMATE DISPLAY

OWNER'S MANUAL

Please read this manual carefully before operating your set and retain it for future reference.

65EC9700



* M F L 6 8 0 2 7 9 4 2 *

www.lg.com

P/NO : MFL68027942 (1411-REV01)

IMPORTANT SAFETY INSTRUCTIONS

Always comply with the following precautions to avoid dangerous situations and ensure peak performance of your product.



TO REDUCE THE RISK OF ELECTRIC SHOCK DO NOT REMOVE COVER (OR BACK). NO USER SERVICEABLE PARTS INSIDE. REFER TO QUALIFIED SERVICE PERSONNEL.

 The lightning flash with arrowhead symbol, within an equilateral triangle, is intended to alert the user to the presence of uninsulated dangerous voltage within the product's enclosure that may be of sufficient magnitude to constitute a risk of electric shock to persons.

 The exclamation point within an equilateral triangle is intended to alert the user to the presence of important operating and maintenance (servicing) instructions in the literature accompanying the appliance.

WARNING/CAUTION

- TO REDUCE THE RISK OF FIRE AND ELECTRIC SHOCK, DO NOT EXPOSE THIS PRODUCT TO RAIN OR MOISTURE.

WARNING

If you ignore the warning message, you may be seriously injured or there is a possibility of accident or death.

CAUTION

If you ignore the caution message, you may be slightly injured or the product may be damaged.

NOTE

The note helps you understand and use the product safely. Please read the note carefully before using the product.

Read these instructions.
Keep these instructions.
Heed all warnings.
Follow all instructions.



- Do not use this apparatus near water.



- Clean only with a dry cloth.



- Do not block any ventilation openings. Install in accordance with the manufacturer's instructions.



- Do not install near any heat sources such as radiators, heat registers, stoves, or other apparatus (including amplifiers) that produce heat.



- Do not defeat the safety purpose of the polarized or grounding-type plug. A polarized plug has two blades with one wider than the other. A grounding type plug has two blades and a third grounding prong. The wide blade or the third prong are provided for your safety. If the provided plug does not fit into your outlet, consult an electrician for replacement of the obsolete outlet (Can differ by country).



- Do not press strongly upon the panel with a hand or a sharp object such as a nail, pencil or pen, or make a scratch on it.



WARNING: This product contains chemicals known to the State of California to cause cancer and birth defects or other reproductive harm.

Wash hands after handling.

- Protect the power cord from being walked on or pinched particularly at plugs, convenience receptacles, and the point where they exit from the apparatus.



- Only use attachments/accessories specified by the manufacturer.



- Use only with a cart, stand, tripod, bracket, or table specified by the manufacturer, or sold with the apparatus. When a cart is used, use caution when moving the cart/apparatus combination to avoid injury from tip-over.



- Unplug this apparatus during lightning storms or when unused for long periods of time.

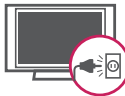

- Refer all servicing to qualified service personnel. Servicing is required when the apparatus has been damaged in any way, such as power-supply cord or plug is damaged, liquid has been spilled or objects have fallen into the apparatus, the apparatus has been exposed to rain or moisture, does not operate normally, or has been dropped.



- Do not stick metal objects or any other conductive material into the power cord. Do not touch the end of the power cord while it is plugged in.
- Keep the packing anti-moisture material or vinyl packing out of the reach of children. Anti-moisture material is harmful if swallowed. If swallowed by mistake, force the patient to vomit and visit the nearest hospital. Additionally, vinyl packing can cause suffocation. Keep it out of the reach of children.

- CAUTION concerning the Power Cord (Can differ by country):

Check the specification page of this owner's manual to be certain. Do not connect too many appliances to the same AC power outlet as this could result in fire or electric shock. Do not overload wall outlets. Overloaded wall outlets, loose or damaged wall outlets, extension cords, frayed power cords, or damaged or cracked wire insulation are dangerous. Any of these conditions could result in electric shock or fire. Periodically examine the cord of your appliance, and if its appearance indicates damage or deterioration, unplug it, discontinue use of the appliance, and have the cord replaced with an exact replacement part by an authorized service. Protect the power cord from physical or mechanical abuse, such as being twisted, kinked, pinched, closed in a door, or walked upon. Pay particular attention to plugs, wall outlets, and the point where the cord exits the appliance. Do not move the TV with the power cord plugged in. Do not use a damaged or loose power cord. Be sure do grasp the plug when unplugging the power cord. Do not pull on the power cord to unplug the TV.



- **Warning** - To reduce the risk of fire or electrical shock, do not expose this product to rain, moisture or other liquids. Do not touch the TV with wet hands. Do not install this product near flammable objects such as gasoline or candles, or expose the TV to direct air conditioning.



- Do not expose to dripping or splashing and do not place objects filled with liquids, such as vases, cups, etc. on or over the apparatus (e.g. on shelves above the unit).



- **Grounding**

(Except for devices which are not grounded.)

Ensure that you connect the earth ground wire to prevent possible electric shock (i.e. a TV with a three-prong grounded AC plug must be connected to a three-prong grounded AC outlet). If grounding methods are not possible, have a qualified electrician install a separate circuit breaker. Do not try to ground the unit by connecting it to telephone wires, lightning rods, or gas pipes.

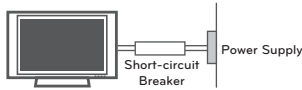

- As long as this unit is connected to the AC wall outlet, it is not disconnected from the AC power source even if the unit is turned off.
- Do not attempt to modify this product in any way without written authorization from LG Electronics. Unauthorized modification could void the user's authority to operate this product.

- **Outdoor Antenna Grounding**

(Can differ by country):

If an outdoor antenna is installed, follow the precautions below. An outdoor antenna system should not be located in the vicinity of overhead power lines or other electric light or power circuits, or where it can come in contact with such power lines or circuits as death or serious injury can occur. Be sure the antenna system is grounded so as to provide some protection against voltage surges and built-up static charges. Section 810 of the National Electrical Code (NEC) in the U.S.A. provides information with respect to proper grounding of the mast and supporting structure, grounding of the lead-in wire to an antenna discharge unit, size of grounding conductors, location of antenna discharge unit, connection to grounding electrodes and requirements for the grounding electrode.

Antenna grounding according to the National Electrical Code, ANSI/NFPA 70

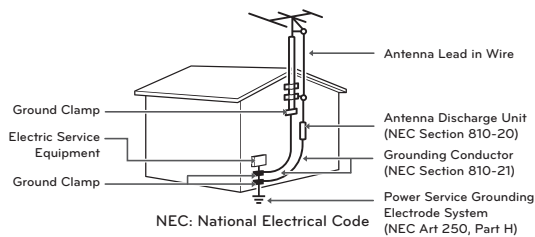

- **Cleaning**

When cleaning, unplug the power cord and wipe gently with a soft cloth to prevent scratching. Do not spray water or other liquids directly on the TV as electric shock may occur. Do not clean with chemicals such as alcohol, thinners or benzene.

- **Moving**

Make sure the product is turned off, unplugged and all cables have been removed. It may take 2 or more people to carry larger TVs. Do not press or put stress on the front panel of the TV.

- **Ventilation**

Install your TV where there is proper ventilation. Do not install in a confined space such as a bookcase. Do not cover the product with cloth or other materials while plugged. Do not install in excessively dusty places.

- If you smell smoke or other odors coming from the TV, unplug the power cord and contact an authorized service center.
- Keep the product away from direct sunlight.
- Never touch this apparatus or antenna during a thunder or lightning storm.
- When mounting a TV on the wall, make sure not to install the TV by hanging the power and signal cables on the back of the TV.
- Do not allow an impact shock or any objects to fall into the product, and do not drop anything onto the screen.
- **DISCONNECTING THE DEVICE FROM THE MAIN POWER**
The Power Plug is the disconnecting device. In case of an emergency, the Power Plug must remain readily accessible.
- **Batteries**
Store the accessories (battery, etc.) in a safe location out of the reach of children.
- This apparatus use batteries. In your community there might be regulations that require you to dispose of these batteries properly due to environmental considerations. Please contact your local authorities for disposal or recycling information.
- Do not dispose of batteries in a fire.
- Do not short circuit, disassemble or allow the batteries to overheat.
- Do not use high voltage electrical equipment near the TV, (e.g. bug zapper). This may result in product malfunction.
- **Dot Defect**
The Plasma or LCD panel is a high technology product with resolution of two million to six million pixels. In a very few cases, you could see fine dots on the screen while you're viewing the TV. Those dots are deactivated pixels and do not affect the performance and reliability of the TV.

- **Generated Sound**

Cracking noise A cracking noise that occurs when watching or turning off the TV is generated by plastic thermal contraction due to temperature and humidity. This noise is common for products where thermal deformation is required.

Electrical circuit humming/panel buzzing A low level noise is generated from a high-speed switching circuit, which supplies a large amount of current to operate a product. It varies depending upon the product.

This generated sound does not affect the performance and reliability of the product.

- Take care not to touch the ventilation openings. When watching the TV for a long period, the ventilation openings may become hot. This does not affect the performance of the product or cause defects in the product.
- Do not install this product on a wall if it could be exposed to oil or oil mist. This may damage the product and cause it to fall.
- If the TV feels cold to the touch, there may be a small flicker when it is turned on. This is normal, there is nothing wrong with TV. Some minute dot defects may be visible on the screen, appearing as tiny red, green, or blue spots. However, they have no adverse effect on the TV's performance. Avoid touching the LCD screen or holding your finger(s) against it for long periods of time. Doing so may produce some temporary distortion effects on the screen.

Preventing Image burn or Burn-in on your TV screen

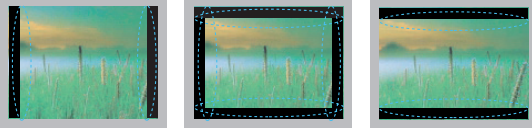

- If a fixed image displays on the TV screen for a long period of time, it will be imprinted and become a permanent disfigurement on the screen. This is image burn or burn-in and not covered by the warranty.
- If the aspect ratio of the TV is set to 4:3 for a long period of time, image burn may occur on the letterboxed area of the screen.
- Avoid displaying a fixed image on the TV screen for a long period of time (1 or more hours for OLED). to prevent image burn.
- **Preventing Screen Burn**
Displaying still images, such as a station's logo, subtitle, screen menu, video game or computer screen, for a long time may damage the screen, causing screen burn which can remain for a long time or never disappear. Do not display still images for over an hour.

For USA and Canada

FCC NOTICE

This equipment has been tested and found to comply with the limits for a Class B digital device, pursuant to Part 15 of the FCC Rules. These limits are designed to provide reasonable protection against harmful interference in a residential installation. This equipment generates, uses and can radiate radio frequency energy and, if not installed and used in accordance with the instructions, may cause harmful interference to radio communications. However, there is no guarantee that interference will not occur in a particular installation. If this equipment does cause harmful interference to radio or television reception, which can be determined by turning the equipment off and on, the user is encouraged to try to correct the interference by one or more of the following measures:

- Reorient or relocate the receiving antenna.
- Increase the separation between the equipment and the receiver.
- Connect the equipment to an outlet on a circuit different from that to which the receiver is connected.
- Consult the dealer or an experienced radio/TV technician for help.

This device complies with part 15 of the FCC Rules. Operation is subject to the following two conditions: (1) this device may not cause harmful interference and (2) this device must accept any interference received, including interference that may cause undesired operation of the device.

Any changes or modifications in construction of this device which are not expressly approved by the party responsible for compliance could void the user's authority to operate the equipment.

NOTE TO CABLE/TV INSTALLER

This reminder is provided to call the CATV system installer's attention to Article 820-40 of the National Electric Code (U.S.A.). The code provides guidelines for proper grounding and, in particular, specifies that the cable ground shall be connected to the grounding system of the building, as close to the point of the cable entry as practical.

Viewing 3D Imaging

WARNING

Viewing Environment

- Viewing Time
 - When watching 3D contents, take 5 to 15 minute breaks every hour. Viewing 3D contents for a long period of time may cause headache, dizziness, fatigue or eye strain.

Those that have a photosensitive seizure or chronic illness

- Some users may experience a seizure or other abnormal symptoms when they are exposed to a flashing light or particular pattern from 3D contents.
- Do not watch 3D videos if you feel nausea, are pregnant and/ or have a chronic illness such as epilepsy, cardiac disorder, or blood pressure disease, etc.
- 3D Contents are not recommended to those who suffer from stereo blindness or stereo anomaly. Double images or discomfort in viewing may be experienced.
- If you have strabismus (cross-eyed), amblyopia (weak eyesight) or astigmatism, you may have trouble sensing depth and easily feel fatigue due to double images. It is advised to take frequent breaks than the average adult.
- If your eyesight varies between your right and left eye, revise your eyesight prior to watching 3D contents.

Symptoms which require discontinuation or refraining from watching 3D contents

- Do not watch 3D contents when you feel fatigue from lack of sleep, overwork or drinking.
- When these symptoms are experienced, stop using/ watching 3D contents and get enough rest until the symptom subsides.
 - Consult your doctor when the symptoms persist. Symptoms may include headache, eyeball pain, dizziness, nausea, palpitation, blurriness, discomfort, double image, visual inconvenience or fatigue.

CAUTION

Viewing Environment

- Viewing Distance
 - Maintain a distance of at least twice the screen diagonal length when watching 3D contents. If you feel discomfort in viewing 3D contents, move further away from the TV.

Viewing Age

- Infants / Children
 - Usage/ Viewing 3D contents for children under the age of 5 are prohibited.
 - Children under the age of 10 may overreact and become overly excited because their vision is in development (for example: trying to touch the screen or trying to jump into it. Special monitoring and extra attention is required for children watching 3D contents.
 - Children have greater binocular disparity of 3D presentations than adults because the distance between the eyes is shorter than one of adults. Therefore they will perceive more stereoscopic depth compared to adults for the same 3D image.
- Teenagers
 - Teenagers under the age of 19 may be stimulated to light coming from 3D videos. Advise them not to watch 3D videos for a long time when they are tired.
- Elderly
 - The elderly may perceive less of a 3D effect than the youth. Do not sit closer to the TV than the recommended distance.

Cautions when using the 3D glasses

- Make sure to use LG 3D glasses. Otherwise, you may not be able to view 3D videos properly.
- Do not use 3D glasses instead of your normal glasses, sunglasses or protective goggles.
- Using modified 3D glasses may cause eye strain or image distortion.
- Do not keep your 3D glasses in extremely high or low temperatures. It will cause deformation.
- The 3D glasses are fragile and are easy to be scratched. Always use a soft, clean piece of cloth when wiping the lenses. Do not scratch the lenses of the 3D glasses with sharp objects or clean/wipe them with chemicals.

LICENSES

Supported licenses may differ by model. For more information about licenses, visit www.lg.com.



OPEN SOURCE SOFTWARE NOTICE

To obtain the source code under GPL, LGPL, MPL and other open source licenses, that is contained in this product, please visit <http://opensource.lge.com>.

In addition to the source code, all referred license terms, warranty disclaimers and copyright notices are available for download.

LG Electronics will also provide open source code to you on CD-ROM for a charge covering the cost of performing such distribution (such as the cost of media, shipping and handling) upon email request to opensource@lge.com. This offer is valid for three (3) years from the date on which you purchased the product.

TABLE OF CONTENTS

2 IMPORTANT SAFETY INSTRUCTIONS

6 Viewing 3D Imaging

7 LICENSES

7 OPEN SOURCE SOFTWARE NOTICE

8 TABLE OF CONTENTS

9 INSTALLATION PROCEDURE

9 ASSEMBLING AND PREPARING

- 9 Unpacking
- 11 Optional Extras
- 12 Parts and Buttons
- 13 Using the Joystick Button
- 14 Lifting and Moving the TV
- 14 Setting Up the TV
 - 14 - Attaching the AV Cover
 - 15 - Mounting on a Table
 - 16 - Tidying Cables
 - 16 - Mounting on a Wall
- 18 Using Built-in Camera
 - 18 - Preparing Built-in Camera
 - 19 - Name of Parts for the Built-In Camera
 - 19 - Checking the Camera's Shooting Range

20 MAKING CONNECTIONS

- 20 Connecting to an Antenna or Cable
- 21 Connecting to an HD receiver, DVD Player, or VCR
 - 21 - HDMI Connection
 - 22 - DVI to HDMI Connection
 - 23 - Connecting to a Mobile Phone
 - 24 - Component Connection
 - 25 - Composite Connection
- 26 Connecting a PC
 - 26 - HDMI Connection or DVI to HDMI Connection
- 28 Connecting to an Audio System
 - 28 - Digital Optical Audio Connection
- 29 Connecting headphones
- 30 Connecting a USB Device

31 MAGIC REMOTE FUNCTIONS

- 32 Registering Magic Remote
- 32 How to use Magic Remote
- 32 Precautions to Take when Using the Magic Remote

33 USING THE USER GUIDE

34 SPECIFICATIONS

34 EXTERNAL CONTROL DEVICE SETUP

35 MAINTENANCE

- 35 Cleaning Your TV
 - 35 - Screen, Frame, Cabinet, and Stand
 - 35 - Power Cord

35 TROUBLESHOOTING

! NOTE

- Image shown may differ from your TV.
- Your TV's OSD (On Screen Display) may differ slightly from that shown in this manual.
- The available menus and options may differ from the input source or product model that you are using.
- New features may be added to this TV in the future.

INSTALLATION PROCEDURE

- 1 Open the package and make sure all the accessories are included.
- 2 Connect an external device to the TV set.
- 3 Make sure the network connection is available.

You can use the TV network functions only when the network connection is made.

* When the TV is turned on for the first time after being shipped from the factory, initialization of the TV may take approximately one minute.

ASSEMBLING AND PREPARING

Unpacking

Check your product box for the following items. If there are any missing accessories, contact the local dealer where you purchased your product. The illustrations in this manual may differ from the actual product and item.

CAUTION

- Do not use any unapproved items to ensure the safety and product life span.
- Any damages or injuries by using unapproved items are not covered by the warranty.
- In case of some model, the thin film on screen is a part of TV, So don't take it off.

NOTE

- The items supplied with your product may vary depending upon the model.
- Product specifications or contents of this manual may be changed without prior notice due to upgrade of product functions.
- For an optimal connection, HDMI cables and USB devices should have bezels less than 10 mm thick (0.39 inches) and 18 mm (0.7 inches) width.
- Use an extension cable that supports USB 2.0 if the USB cable or USB FLASH DRIVE does not fit into your TV's USB port.
- Use a certified cable with the HDMI logo attached. If you do not use a certified HDMI cable, the screen may not display or a connection error may occur.
- Recommended HDMI cable types
 - High-Speed HDMI^{®/TM} cable
 - High-Speed HDMI^{®/TM} cable with Ethernet

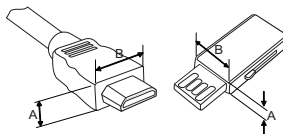

*A  10 mm (0.39 inches)

*B  18 mm (0.7 inches)

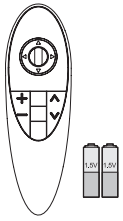

**Magic Remote,
Batteries (AA)**
(See page 31.)



Owner's Manual

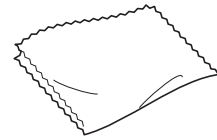

Polishing cloth
Use this to remove dust from the cabinet.



Cinema 3D Glasses
The number of 3D glasses may differ depending upon the model or country.



AV Cover
(See page 14.)

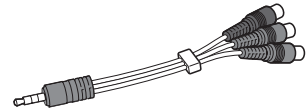

Component Video Cable
(See page 24.)

ENGLISH

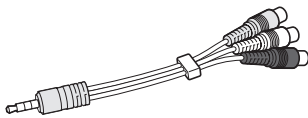

Composite Video Cable
(See page 24 and 25.)

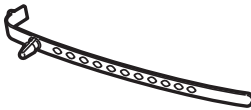

Cable Holder
(See page 16.)

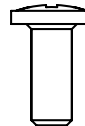

Screws
2 EA, M4 x L10
(See page 16.)

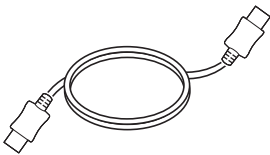

HDMI Cable
(See page 21 and 26.)

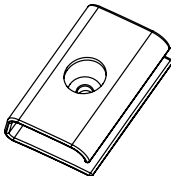

Cable Management
2 EA
(See page 16.)

Optional Extras

Optional extras can be changed or modified for quality improvement without any notification.

Contact your dealer for buying these items.

These devices only work with certain models.

The model name or design may be changed manufacturer's circumstances or policies.

AN-MR500
Magic Remote

AG-F***
Cinema 3D Glasses

LG Audio Device

AG-F*DP**
Dual Play Glasses

Parts and Buttons

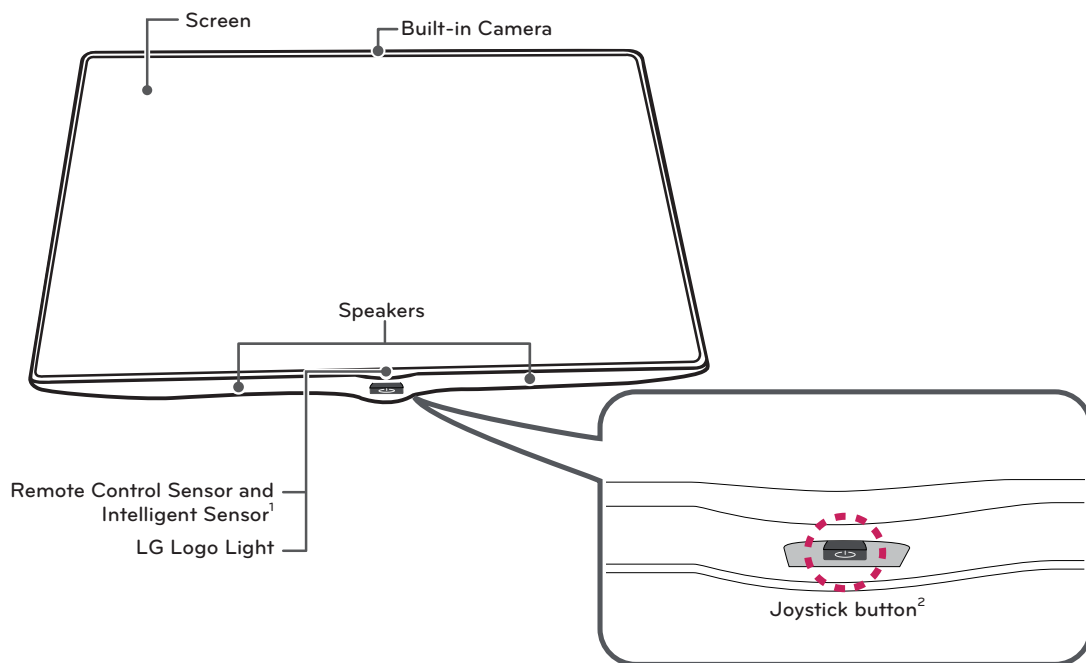

- 1 Intelligent sensor - Adjusts the image quality and brightness based on the surrounding environment.
- 2 Joystick button is located below the screen of TV.



! NOTE

- You can set the LG Logo Light to be on or off by selecting **GENERAL** in the main menus.

Using the Joystick Button

You can operate the TV by pressing the button or moving the joystick left, right, up, or down.

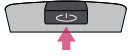
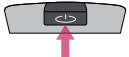
Basic functions

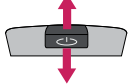



	Power On	When the TV is turned off, place your finger on the joystick button and press it once and release it.
	Power Off	When the TV is turned on, place your finger on the joystick button and press it once for a few seconds and release it.
	Volume Control	If you place your finger over the joystick button and move it left or right, you can adjust the volume level you want.
	Channels Control	If you place your finger over the joystick button and move it up or down, you can scroll through the saved channels you want.

NOTE

- When your finger over the joystick button and push it up, down, left, or right, be careful not to press the joystick button. If you press the joystick button first, you may not be able to adjust the volume level and/or scroll through saved channels.

Adjusting the menu

When the TV is turned on, press the joystick button one time.
You can adjust the Menu items (⏻, ✕, 📶) moving the joystick button left or right.

		TV off	Turns the power off.
		close	Clears on-screen displays and returns to TV viewing.
		Input	Changes the input source.

Lifting and Moving the TV

When moving or lifting the TV, read the following to prevent the TV from being scratched or damaged and for safe transportation regardless of its type and size.

CAUTION

- Avoid touching the screen at all times, as this may result in damage to the screen.
- Do not place the product on the floor with its front facing down. Doing so may result in damage to the screen.

- It is recommended to move the TV in the box or packing material that the TV originally came in.
- Before moving or lifting the TV, disconnect the power cord and all cables.
- When holding the TV, the screen should face away from you to avoid damage.

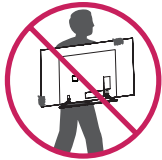

- Hold the top and bottom of the TV frame firmly. Make sure not to hold the transparent part, speaker, or speaker grill area.

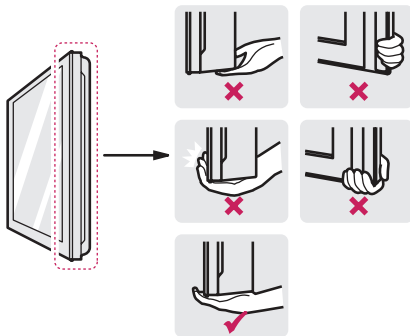

- When transporting a large TV, there should be at least 2 people.
- When transporting the TV by hand, hold the TV as shown in the following illustration.

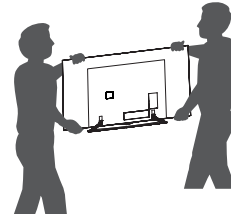

- When transporting the TV, do not expose the TV to jolts or excessive vibration.
- When transporting the TV, keep the TV upright; never turn the TV on its side or tilt towards the left or right.
- Do not apply excessive pressure to cause flexing / bending of frame chassis as it may damage screen.
- Be sure to keep your TV upright instead of laying or tilting it while moving the TV.
- When handling the TV, be careful not to damage the protruding joystick button.

Setting Up the TV

Attaching the AV Cover

Please assemble the AV cover as shown in the figure.

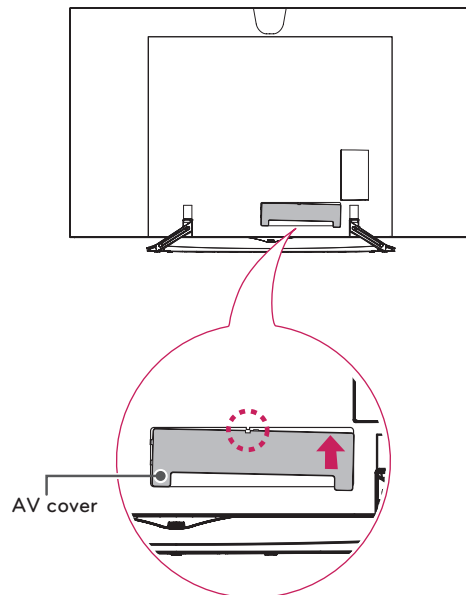

Mounting on a Table

- Lift and tilt the TV into its upright position on a table.
 - Leave a 10 cm (4 inch) (minimum) space from the wall for proper ventilation.

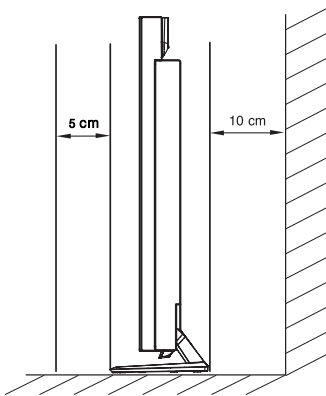
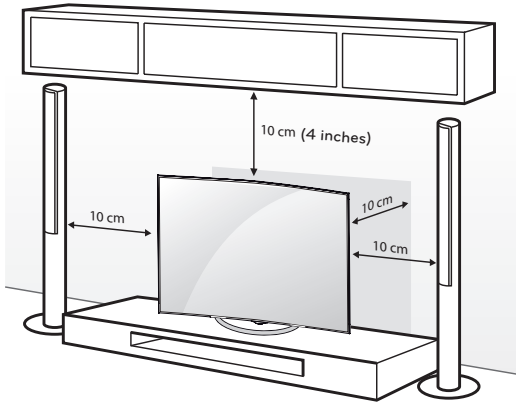

- Connect the power cord to a wall outlet.

CAUTION

- Do not place the TV near or on sources of heat, as this may result in fire or other damage.

Securing the TV to a wall (optional)

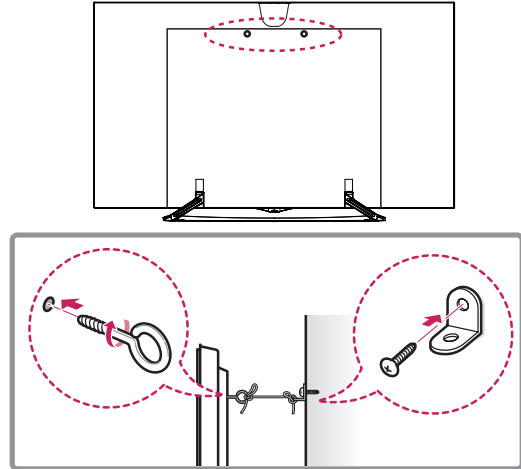

- Insert and tighten the eye-bolts, or TV brackets and bolts on the back of the TV.
 - If there are bolts inserted at the eye-bolt's position, remove the bolts first.
- Mount the wall brackets with the bolts to the wall. Match the location of the wall bracket and the eye-bolts on the rear of the TV.
- Connect the eye-bolts and wall brackets tightly with a sturdy rope or cable. Make sure to keep the rope parallel to the flat surface.

CAUTION

- Make sure that children do not climb on or hang on the TV.

NOTE

- Use a platform or cabinet that is strong and large enough to support the TV securely.
- Brackets, bolts, and ropes are optional. You can obtain additional accessories from your local dealer.

Tidying Cables

Gather and bind the cables with the cable holder and Cable Management.

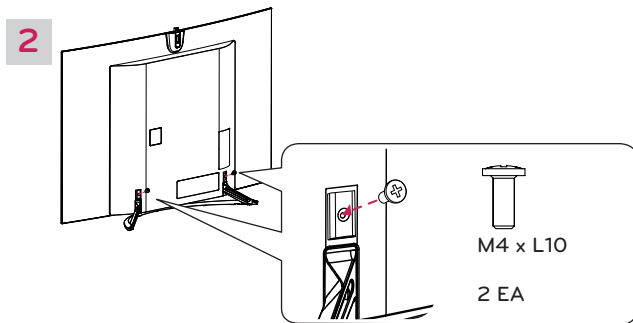
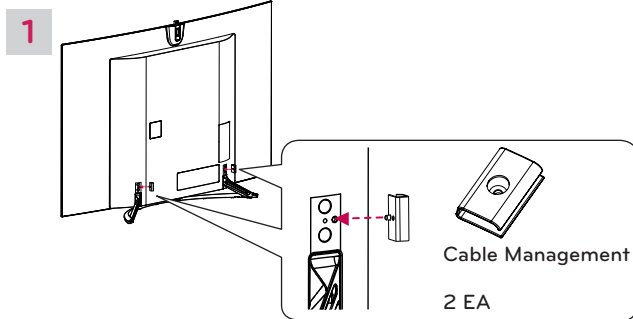

NOTE

- When attaching the cable management, use a magnetic screwdriver.
- If you don't have a magnetic screwdriver, insert the screws into the cable management and then attach it to the TV.

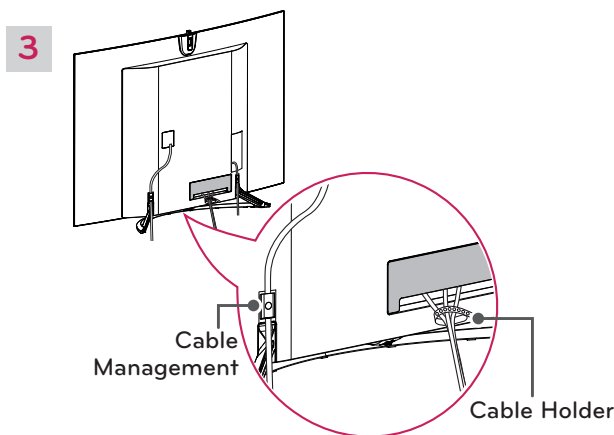

CAUTION

- Do not move the TV by holding the cable management and cable band, as the cable holders may break, and injuries and damage to the TV may occur.

Mounting on a Wall

An optional wall mount can be used with your LG Television. Consult with your local dealer for a wall mount used by your TV model. Carefully attach the wall mount bracket at the rear of the TV. Install the wall mount bracket on a solid wall perpendicular to the floor. If you are attaching the TV to other building materials, please contact qualified personnel to install the wall mount. Detailed instructions will be included with the wall mount. We recommend that you use an LG brand wall mount. When you do not use LG's wall mount bracket, please use wall mount bracket which the distance to the wall is adequately secured for seamless connectivity to external devices.

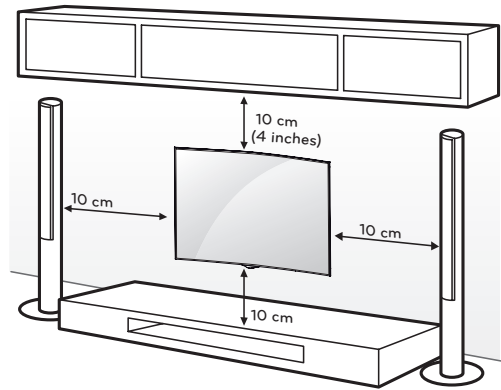

Make sure to use screws and wall mounts that meet the standard. Standard dimensions for the wall mount kits are described in the following table.

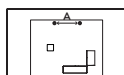
Model	65EC9700
A	210
	
Standard screw	M6
Number of screws	2
Wall mount bracket (optional)	OSW200

Wall mount bracket (optional)	
OSW200	

Removing a stand

1

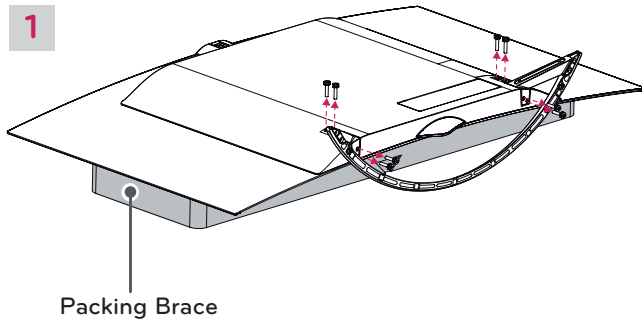

Packing Brace

2

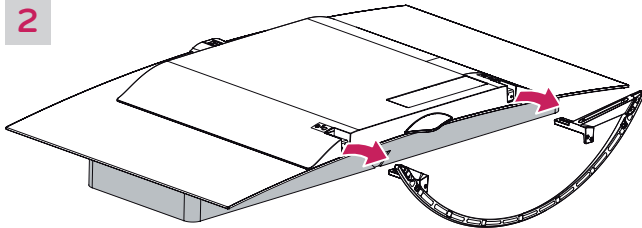

! NOTE

- For more information about mounting on a wall, refer to the OSW200 manual.
- Remove the stand by placing the packing brace as shown in the drawing to prevent damage.
- When mounting the TV on a table, attach the stand by performing the stand removal in reverse.

! CAUTION

(When attaching the stand)

- Make sure that the screws are fastened tightly. (If they are not fastened securely enough, the TV may tilt forward after being installed.)
- Do not tighten the screws with too much force; otherwise they may be damaged and come loose later.

! CAUTION

- Disconnect the power first, and then move or install the TV. Otherwise electric shock may occur.
- If you install the TV on a ceiling or slanted wall, it may fall and result in severe injury. Use an authorized LG wall mount and contact the local dealer or qualified personnel.
- Do not over tighten the screws as this may cause damage to the TV and void your warranty.
- Use the screws and wall mounts that meet the standard. Any damages or injuries by misuse or using an improper accessory are not covered by the warranty.
- You will need at least two people to remove the stand and one more to separate the stand from the TV so it doesn't fall when the screws are removed.

! NOTE

- Use the screws that are listed on the standard screw specifications.
- The wall mount kit includes an installation manual and necessary parts.
- The wall mount bracket is optional. You can obtain additional accessories from your local dealer.
- The length of screws may differ depending upon the wall mount. Make sure to use the proper length.
- For more information, refer to the manual supplied with the wall mount.

Using Built-in Camera

You can make a Skype video call or use the motion recognition function using the built-in camera of the TV.

This TV does not support the use of an external camera.

! NOTE

- Before using the built-in camera, you must recognize the fact that you are legally responsible for the use or misuse of the camera by the relevant national laws including the criminal law.
- The relevant laws include the Personal Information Protection law which regulates the processing and transferring of personal information and the law which regulates the monitoring by camera in a workplace and other places.
- When using the built-in camera, the user must gain consent from the persons being observed. Please avoid using the camera in the following manner. We suggest avoiding the following situations:
 - (1) Using the camera in areas where the use of camera is generally prohibited such as restroom, locker room, fitting room, and security area.
 - (2) Using the camera while causing the infringement of privacy.
 - (3) Using the camera while causing the violation of the relevant regulations or laws.

Preparing Built-in Camera

- 1 Pull up the built-in camera at the back of the TV.

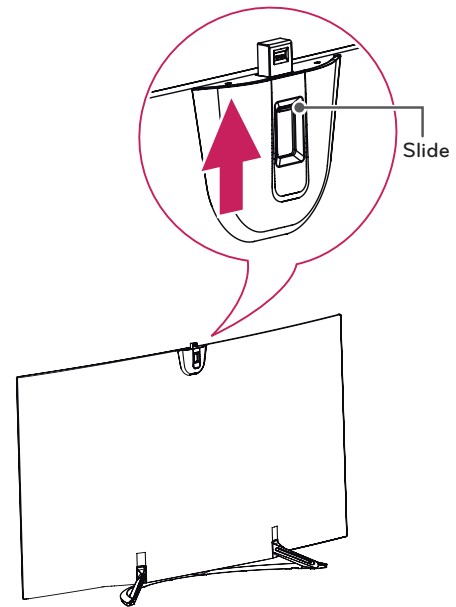

! NOTE

- Remove the protective film before using the built-in camera.

- 2 You can adjust the angle of the camera with the angle adjustment lever on the back of the built-in camera (within 5 degrees vertically).

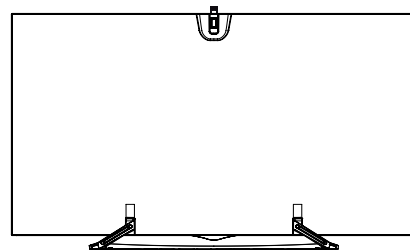
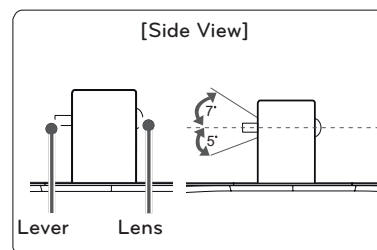

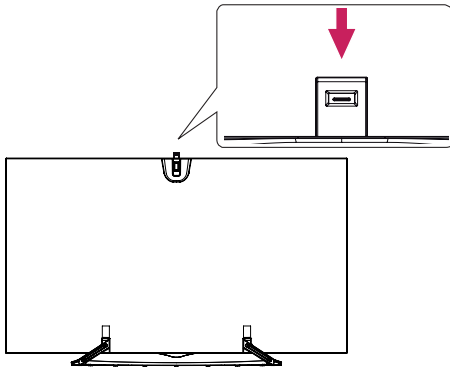

- 3 Pull down the built-in camera when you are not using it.

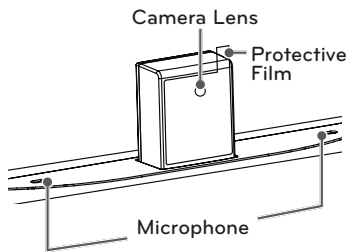

Name of Parts for the Built-In Camera



Checking the Camera's Shooting Range

- 1 Press the  (**Home**) button on the remote control to display the Home menu.
- 2 Select  **CAMERA** and then press the  (**Wheel (OK)**) button.

NOTE

- The optimal distance from the camera to use the motion recognition function is between 1.5 m (5 ft) and 4.5 m (15 ft).

MAKING CONNECTIONS

You can connect various external devices to the TV. Supported external devices are: HD receivers, DVD players, VCRs, audio systems, USB storage devices, PC, gaming devices, and other external devices. For more information on external device's connection, refer to the manual provided with each device.

! NOTE

- If you record a TV program on a DVD recorder or VCR, make sure to connect the TV signal input cable to the TV through a DVD recorder or VCR. For more information of recording, refer to the manual provided with the connected device.
- The external device connections shown may differ slightly from illustrations in this manual.
- Connect external devices to the TV regardless of the order of the TV port.
- If you connect a gaming device to the TV, use the cable supplied with the gaming device.
- Refer to the external equipment's manual for operating instructions.

Connecting to an Antenna or Cable

Connect an antenna, cable, or cable box to watch TV while referring to the following. The illustrations may differ from the actual items and a RF cable is optional.

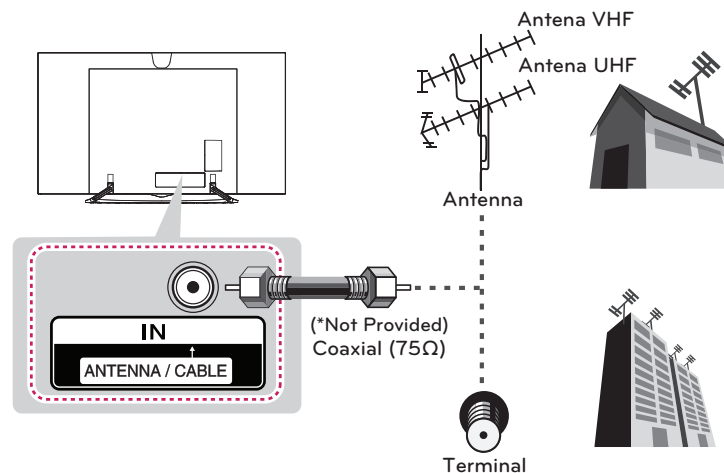

! CAUTION

- Make sure not to bend the copper wire of the RF cable.

Copper wire

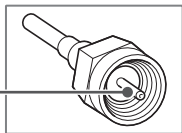

- Complete all connections between devices, and then connect the power cord to the power outlet to prevent damage to your TV.

! NOTE

- Use a signal splitter to use more than 2 TVs.
- DTV Audio Supported Codec: MPEG, Dolby Digital.
- This TV cannot receive UHD (3840 x 2160 pixels) broadcasts directly because the related standards have not been confirmed.

Connecting to an HD receiver, DVD Player, or VCR

Connect an HD receiver, DVD Player, or VCR to the TV and select an appropriate input mode.

NOTE

- HDMI specifications may be different for each input port, so make sure to check the device specifications before connecting.
- The HDMI IN 3 port is especially suitable for the specifications to enjoy UHD Video (4:4:4, 4:2:2) of 4K @ 60 Hz. However, video or audio may not be supported depending upon the specifications of the external equipment. In that case, use any other HDMI IN port.
- Contact customer service for more information on the HDMI specifications of each input port.

HDMI Connection

HDMI is the best way to connect a device.

Transmits digital video and audio signals from an external device to the TV. Connect the external device and the TV with the HDMI cable as shown in the following illustration.

NOTE

- Use the latest High Speed HDMI™ Cable that supports CEC (Customer Electronics Control) function.
- High Speed HDMI™ Cables are tested to carry an HD signal up to 1080p and higher.
- HDMI Audio Supported Format: PCM (32 kHz / 44.1 kHz / 48 kHz / 96 kHz / 192 kHz)
- When you use an HDMI cable (HDMI port3), it is recommended that you use the cable provided. If you use a regular HDMI cable, use a high-speed HDMI cable (3m or less).

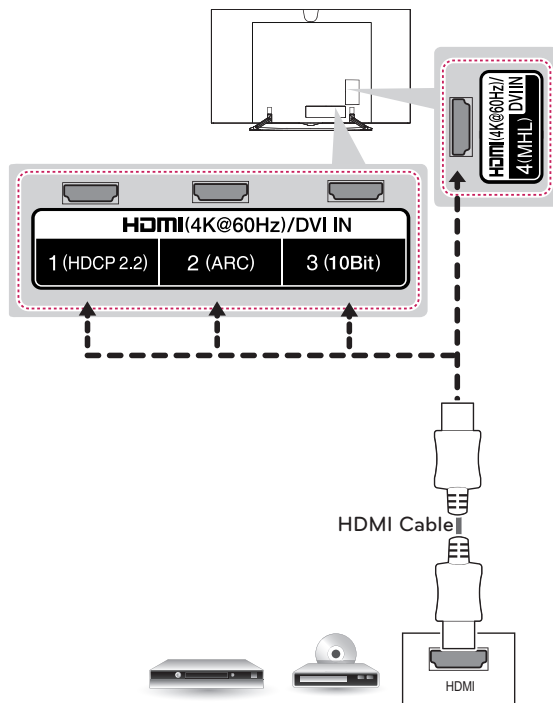

DVD / Blu-Ray / HD Cable Box / HD STB

4K @ 60 Hz Support Format

Resolution	Frame rate (Hz)	Color Depth / Chroma Sampling		
		8 bit	10 bit	12 bit
3840 X 2160p 4096 X 2160p	59.94 60.00	YCbCr 4:2:0	YCbCr 4:2:0 ¹	
		YCbCr 4:2:2 ¹		
		YCbCr 4:4:4 ¹	-	-
		RGB 4:4:4 ¹	-	-

¹ Supported at HDMI IN 3 Port only

ARC (Audio Return Channel)

- When connected with a high-speed HDMI cable, digital audio can be sent to a compatible device without an additional optical audio cable.
- ARC is only supported on the **HDMI (4K @ 60Hz) / DVI IN 2 (ARC)** port. An external audio device that supports ARC should be connected to **HDMI (4K @ 60Hz) / DVI IN 2 (ARC)** if you wish to use ARC.

DVI to HDMI Connection

Transmits the digital video signal from an external device to the TV. Connect the external device and the TV with the DVI-HDMI cable as shown in the following illustration. To transmit an audio signal, connect an audio cable.

NOTE

- When using the HDMI/DVI cable, Single link is only supported.

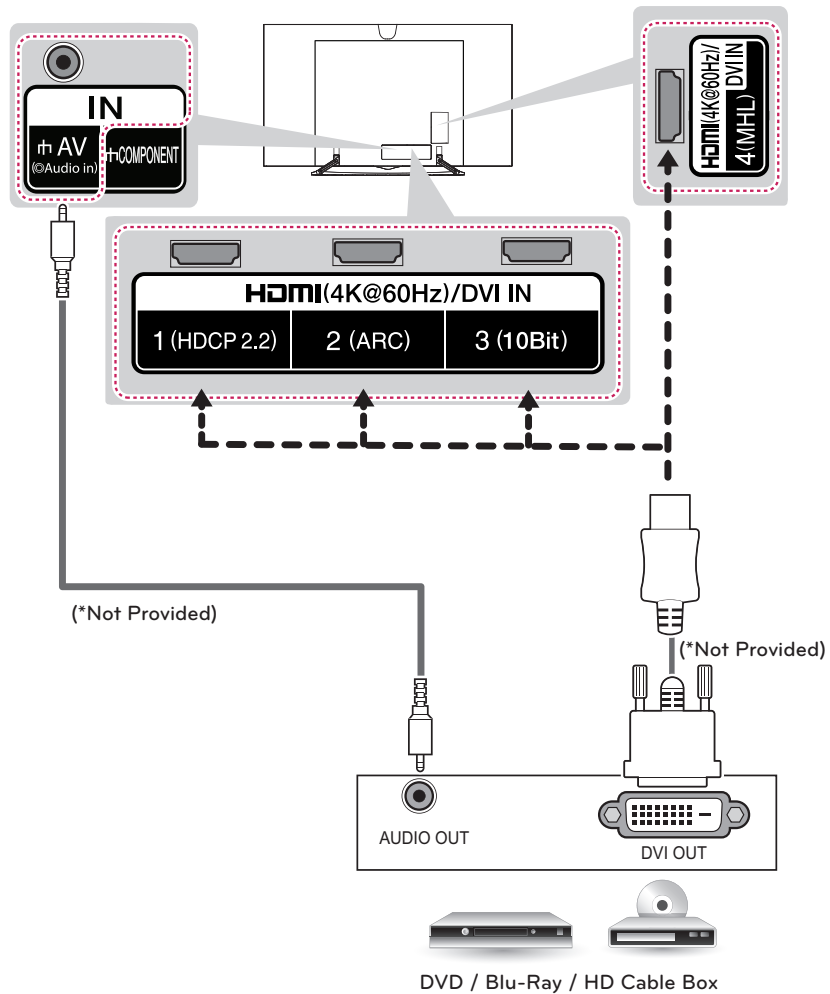

Connecting to a Mobile Phone

Mobile High-definition Link (MHL) is an interface for transmitting digital audio/visual signals from mobile phones to television sets.

NOTE

- Connect the mobile phone to the HDMI (4K @ 60 Hz) / DVI IN 4 (MHL) port to view the phone screen on the TV.
- This works only with an MHL-enabled phone.
- With some MHL supporting mobile phones, you can use the TV remote to control the phone.
- An MHL passive cable is needed to connect the TV and a mobile phone.
- Remove the MHL cable from the TV when:
 - the MHL function is disabled
 - your mobile device is fully charged in standby mode

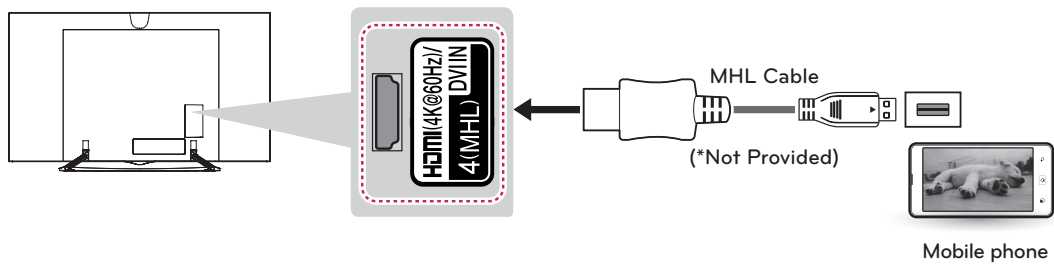

Component Connection

Transmits analog video and audio signals from an external device to the TV. Connect the external device and the TV with a component cable as shown in the following illustration.

NOTE

- If cables are installed incorrectly, it could cause the image to display in black and white or with distorted color.
- Check to ensure the cables are matched with the corresponding color connection.

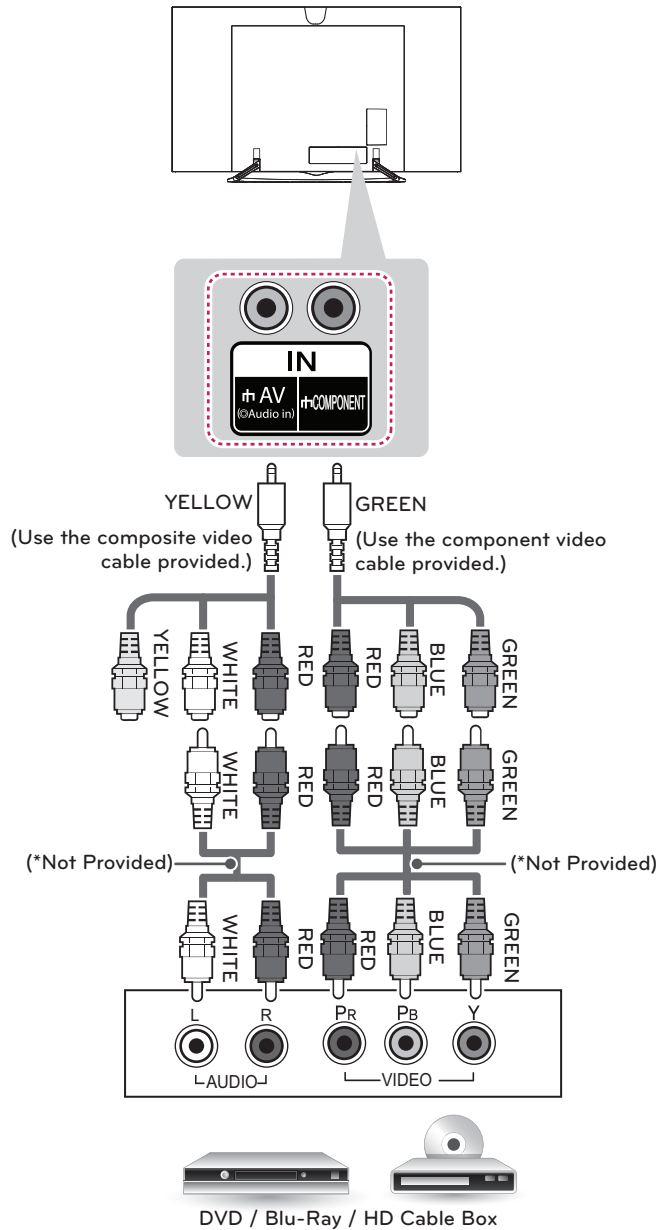

Composite Connection

Transmits analog video and audio signals from an external device to the TV. Connect the external device and the TV with the composite cable as shown in the following illustration.

NOTE

- If you have a mono VCR, connect the audio cable from the VCR to the AUDIO L/MONO jack of the TV.
- **Check to ensure the cables are matched with the corresponding color connection.**

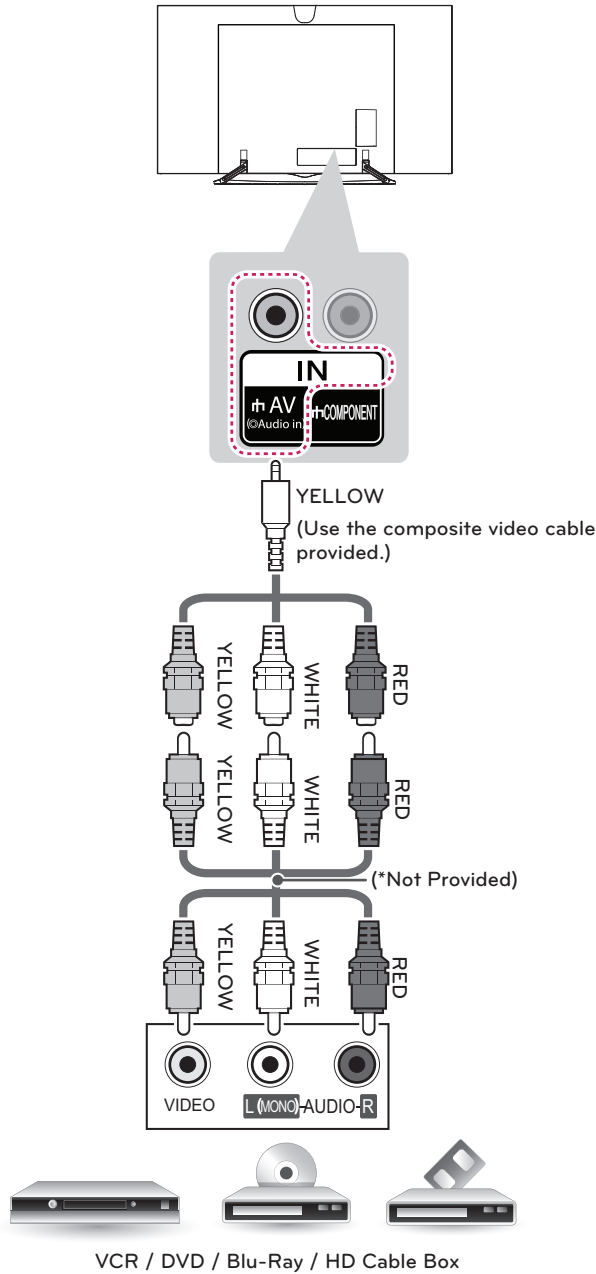

Connecting a PC

NOTE

- Use an HDMI connection for the best image quality.
- Depending upon the graphics card, DOS mode video may not work if a HDMI to DVI Cable is in use.
- In PC mode, there may be noise associated with the resolution, vertical pattern, contrast or brightness. If noise is present, change the PC output to another resolution, change the refresh rate to another rate or adjust the brightness and contrast on the PICTURE menu until the picture is clear.
- The synchronization input form for Horizontal and Vertical frequencies is separate.
- Depending upon the graphics card, some resolution settings may not allow the image to be positioned on the screen properly.
- If you are using DVI out from a PC, you have to connect analog audio separately. Refer to the instructions on the next page.
- When using the HDMI/DVI cable, Single link is only supported.
- If Ultra HD content is played on your PC, video or audio may become disrupted intermittently depending upon your PC's performance.
- HDMI specifications may be different for each input port, so make sure to check the device specifications before connecting.
- The HDMI IN 3 port is especially suitable for the specifications to enjoy UHD Video (4:4:4, 4:2:2) of 4K @ 60 Hz. However, video or audio may not be supported depending upon the specifications of the external equipment. In that case, use any other HDMI IN port.
- Contact customer service for more information on the HDMI specifications of each input port.

HDMI Connection or DVI to HDMI Connection

Choose method A or B to make connection.

Method A: HDMI Connection

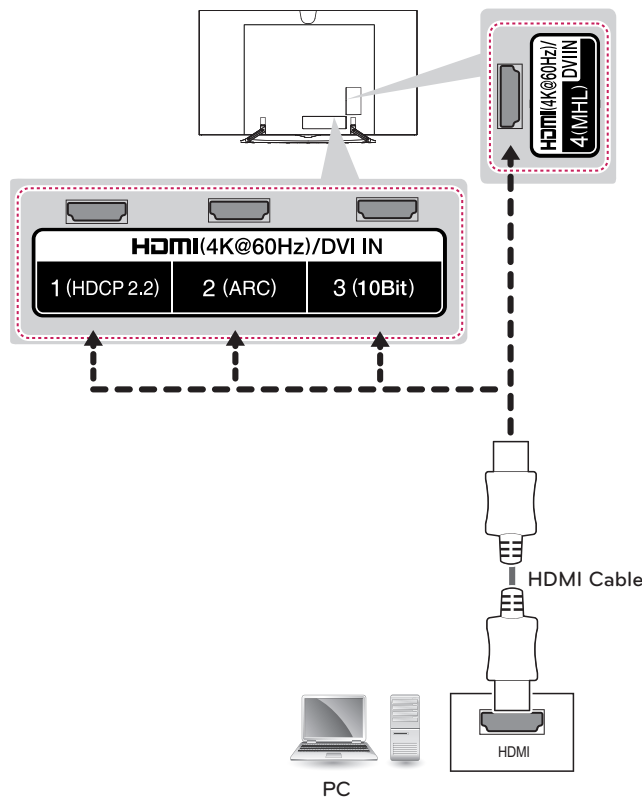

Method B: DVI to HDMI Connection

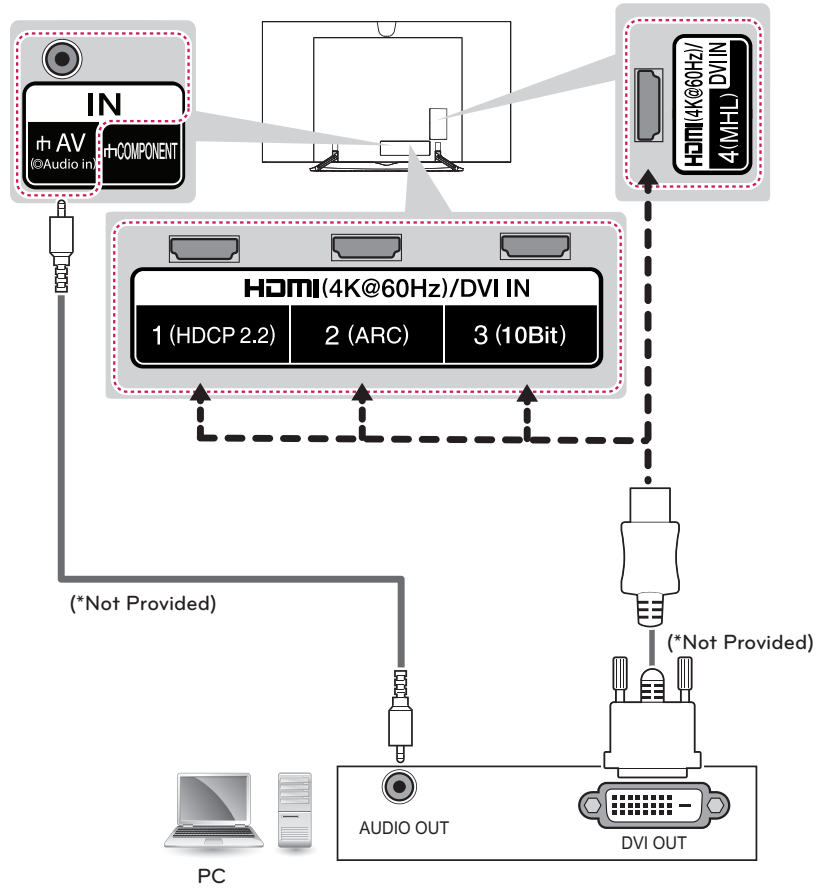

Connecting to an Audio System

You can use an optional external audio system instead of the built-in speaker.

Digital Optical Audio Connection

Transmits a digital audio signal from the TV to an external device. Connect the external device and the TV with the optical audio cable as shown in the following illustration.

! NOTE

- Do not look into the optical output port. Looking at the laser beam may damage your vision.
- Audio with ACP (Audio Copy Protection) function may block digital audio output.

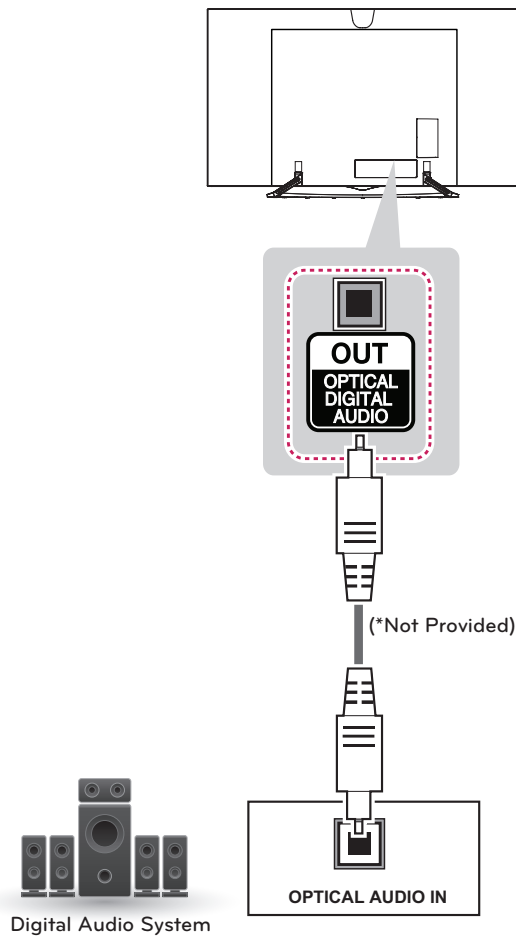

Connecting headphones

Listening to sound with headphones.

! NOTE

- Do not use headsets (earphones) at high volume or for a long time. It may cause damage to your hearing.
- AUDIO menu options are disabled when headphones are connected.
- When changing AV MODE with a headphone connected, the change is applied to video but not to audio.
- Optical Digital Audio Out is not available when connecting a headphone.
- Headphone impedance: 16 Ω
- Max audio output: 0.627 mW to 1.334 mW
- Headphone jack size: 3.5 mm (0.13 inches)

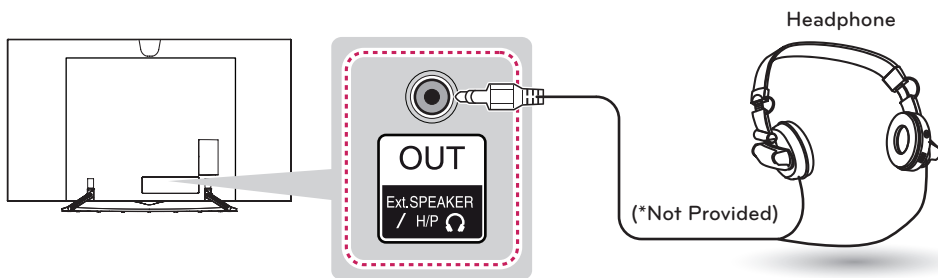

Connecting a USB Device

Connect a USB storage device such as USB flash memory, external hard drive, or a USB memory card reader to the TV and access the Smart Share menu to use various multimedia files.

! NOTE

- Some USB Hubs may not work. If a USB device connected using a USB Hub is not detected, connect it directly to the USB port on the TV.
- Some USB device may not work if it does not meet USB 3.0 standard. In case, connect it to USB IN 2 or USB IN 3 port.

Choose any USB input port to connect.
It does not matter which port you use.

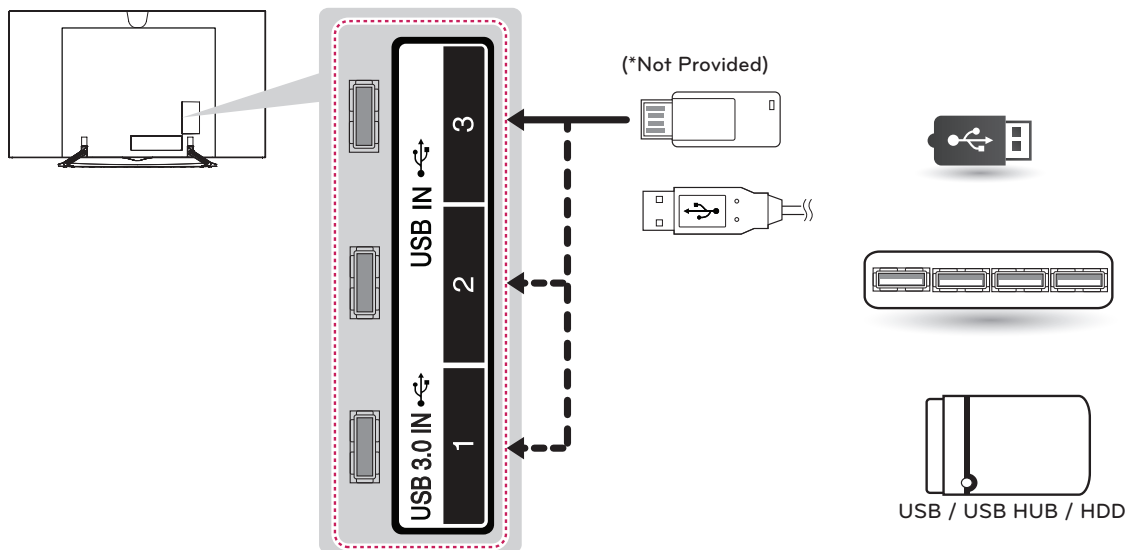

MAGIC REMOTE FUNCTIONS

When the message **Magic Remote battery is low. Change the battery.** is displayed, replace the battery. To install batteries, open the battery cover, replace batteries (1.5 V AA) matching ⊕ and ⊖ ends to the label inside the compartment, and close the battery cover. Failure to match the correct polarities of the battery may cause the battery to burst or leak, resulting in fire, personal injury, or ambient pollution. Be sure to point the remote control at the remote control sensor on the TV. To remove the batteries, perform the installation actions in reverse.

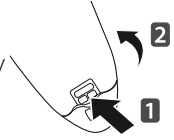

CAUTION

- Do not mix old and new batteries, as this may damage the remote control.

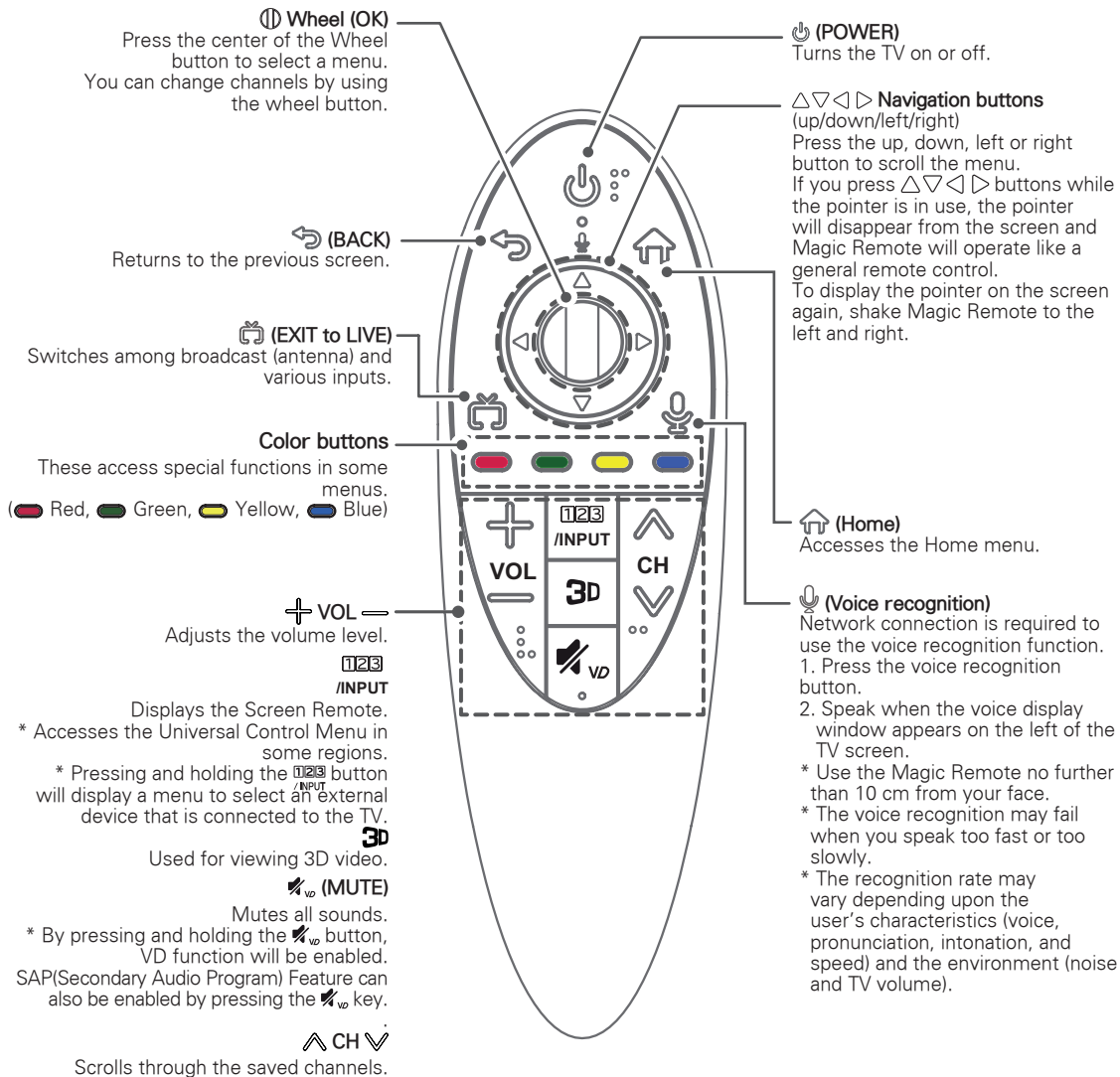

This remote uses infrared light. When in use, it should be pointed in the direction of the TV's remote sensor.



Registering Magic Remote

The Magic Remote operates by pairing with your TV.

How to register the Magic Remote

 (Wheel)	<p>To use the Magic Remote, first pair it with your TV.</p> <ol style="list-style-type: none"> Put batteries into the Magic Remote and turn the TV on. Point the Magic Remote at your TV and press the  Wheel (OK) on the remote control. <p>* If the TV fails to register the Magic Remote, try again after turning the TV off and back on.</p>
---	--





How to deregister the Magic Remote

 (BACK)  (Home)	<p>Press the  (BACK) and  (Home) at the same time, for five seconds, to unpair the Magic Remote with your TV.</p> <p>» Pressing and holding the  (EXIT to LIVE) button will let you cancel and re-register Magic Remote at once.</p>
--	--

Precautions to Take when Using the Magic Remote

- Use the Magic remote within the maximum communication distance (10 m, 32.8 ft). Using the remote control beyond this distance, or with an object obstructing it, may cause a communication failure.
- A communication failure may occur due to nearby devices. Electrical devices such as a microwave oven or wireless LAN product may cause interference, as these use the same bandwidth (2.4 GHz) as the Magic remote.
- The Magic remote may be damaged or may malfunction if it is dropped or receives a heavy impact.
- Take care not to bump into nearby furniture or other people when using the Magic remote.
- Manufacturer and installer cannot provide service related to human safety as the applicable wireless device has possibility of electric wave interference.
- It is recommended that an Access Point (AP) be located more than 1 m (3.28 ft) away from the TV. If the AP is installed closer than 1 m (3.28 ft), the Magic remote may not perform as expected due to frequency interference.

How to use Magic Remote

	<ul style="list-style-type: none"> • Shake the Magic Remote slightly to the right and left or press  (Home),  INPUT,  3D buttons to make the pointer appear on the screen. (In some TV models, the pointer will appear when you turn the Wheel button.) • If the pointer has not been used for a certain period of time or Magic Remote is placed on a flat surface, then the pointer will disappear. • If the pointer does not move as you wish, shake Magic Remote to the left and right. The pointer will move to the center of the screen. • The Magic Remote depletes batteries faster than a normal remote due to the additional features.
---	--

USING THE USER GUIDE

User Guide allows you to easily access detailed TV information.

- 1 Press **Home** button to access the Home menu.
- 2 Select **User Guide** and press the **Wheel (OK)** button.

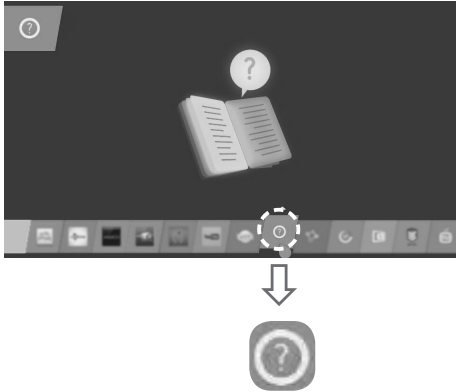

SPECIFICATIONS

Product specifications may be changed without prior notice due to upgrade of product functions.

Power requirement	AC 120 V~ 50 / 60 Hz	
Television System	NTSC-M, ATSC, 64 & 256 QAM	
Program Coverage	VHF 2-13, UHF 14-69, CATV 1-135, DTV 2-69, CADTV 1-135	
External Antenna Impedance	75 Ω	
Environment condition	Operating Temperature	0 - 40 °C (32 °F ~ 104 °F)
	Operating Humidity	Less than 80 %
	Storage Temperature	-20 - 60 °C (-4 °F ~ 140 °F)
	Storage Humidity	Less than 85 %

MODELS		65EC9700 (65EC9700-UA)
Dimensions (W x H x D)	With stand	1,447 x 880 x 256.6 (mm)
		56.9 x 34.6 x 10.1 (inch)
	Without stand	1,447 x 844 x 56.3 (mm)
		56.9 x 33.2 x 2.2 (inch)
Weight	With stand	25.5 kg (56.2 lbs)
	Without stand	24.1 kg (53.1 lbs)
Current Value / Power consumption		5.4 A / 540 W

Wireless module (LGSWF41) Specifications

Standard	IEEE 802.11a/b/g/n/ac
Frequency Range	2400 to 2483.5 MHz 5150 to 5250 MHz 5725 to 5850 MHz
Output Power (Max.)	802.11a: 11.5 dBm 802.11b: 14.5 dBm 802.11g: 16.5 dBm 802.11n - 2.4GHz: 16.5 dBm 802.11n - 5GHz: 14.5 dBm 802.11ac - 5GHz : 14.5 dBm
<ul style="list-style-type: none"> Because band channel used by the country could be different, the user can not change or adjust the operating frequency and this product is set for the regional frequency table. This device should be installed and operated with minimum distance 20 cm (7.8 inch) between the device and your body. And this phrase is for the general statement for consideration of user environment. Contains FCC ID: BEJLGSWF41 / Contains IC: 2703H-LGSWF41 	

Bluetooth module (BM-LDS401) Specifications

Standard	Bluetooth Version 3.0
Frequency Range	2400 to 2483.5 MHz
Output Power (Max.)	10 dBm or Lower
<ul style="list-style-type: none"> Contains FCC ID : BEJLDS401 / Contains IC : 2703H-LDS401 	

EXTERNAL CONTROL DEVICE SETUP

To obtain the external control device setup information, please visit www.lg.com .

MAINTENANCE

Cleaning Your TV

Clean your TV regularly to keep it at peak performance and to extend the product lifespan.

 **CAUTION**

- Before cleaning, turn the power off and disconnect the power cord and all other cables.
- When the TV is left unattended or unused for a long time, disconnect the power cord from the wall outlet to prevent possible damage from lightning or power surges.

Screen, Frame, Cabinet, and Stand

To remove dust or light dirt, wipe the surface with a dry, clean, and soft cloth.

To remove major dirt, wipe the surface with a soft cloth dampened in clean water or a diluted mild detergent. Then wipe immediately with a dry cloth.

 **CAUTION**

- Do not push, rub, or hit the surface with your fingernail or a sharp object, as this may result in scratches on the screen and image distortions.
- Do not use any chemicals, such as waxes, benzene, alcohol, thinners, insecticides, air fresheners, or lubricants, as these may damage the screen's finish and cause discoloration.
- Do not spray liquid onto the surface. If water enters the TV, it may result in fire, electric shock, or malfunction.

Power Cord

Remove the accumulated dust or dirt on the power cord regularly.

TROUBLESHOOTING

Problem	Solution
Cannot control the TV with the remote control.	<ul style="list-style-type: none"> • Check the remote control sensor on the product and try again. • Check if there is any obstacle between the product and the remote control. • Check if the batteries are still working and properly installed (⊕ to ⊕, ⊖ to ⊖).
No image display and no sound is produced.	<ul style="list-style-type: none"> • Check if the product is turned on. • Check if the power cord is connected to a wall outlet. • Check if there is a problem in the wall outlet by connecting other products.
The TV turns off suddenly.	<ul style="list-style-type: none"> • Check the power control settings. The power supply may be interrupted. • Check if the Sleep Timer/Time Power Off is activated in the TIMERS settings. • If there is no signal while the TV is on, the TV will turn off automatically after 15 minutes of inactivity.

CHILD SAFETY:

PROPER TELEVISION PLACEMENT MATTERS



THE CONSUMER ELECTRONICS INDUSTRY CARES

- Manufacturers, retailers and the rest of the consumer electronics industry are committed to making home entertainment safe and enjoyable.
- As you enjoy your television, please note that all televisions – new and old- must be supported on proper stands or installed according to the manufacturer's recommendations. Televisions that are inappropriately situated on dressers, bookcases, shelves, desks, speakers, chests, carts, etc., may fall over, resulting in injury.



TUNE IN TO SAFETY

- **ALWAYS** follow the manufacturer's recommendations for the safe installation of your television.
- **ALWAYS** read and follow all instructions for proper use of your television.
- **NEVER** allow children to climb on or play on the television or the furniture on which the television is placed.
- **NEVER** place the television on furniture that can easily be used as steps, such as a chest of drawers.
- **ALWAYS** install the television where it cannot be pushed, pulled over or knocked down.
- **ALWAYS** route cords and cables connected to the television so that they cannot be tripped over, pulled or grabbed.



WALL OR CEILING MOUNT YOUR TELEVISION

- **ALWAYS** contact your retailer about professional installation if you have any doubts about your ability to safely mount your television.
- **ALWAYS** use a mount that has been recommended by the television manufacturer and has a safety certification by an independent laboratory (such as UL, CSA, ETL).
- **ALWAYS** follow all instructions supplied by the television and mount manufacturers.
- **ALWAYS** make sure that the wall or ceiling where you are mounting the television is appropriate. Some mounts are not designed to be mounted to walls and ceilings with steel studs or cinder block construction. If you are unsure, contact a professional installer.
- Televisions can be heavy. A minimum of two people is required for a wall or ceiling mount installation.



MOVING AN OLDER TELEVISION TO A NEW PLACE IN YOUR HOME

- Many new television buyers move their older CRT televisions into a secondary room after the purchase of a flat-panel television. Special care should be made in the placement of older CRT televisions.
- **ALWAYS** place your older CRT television on furniture that is sturdy and appropriate for its size and weight.
- **NEVER** place your older CRT television on a dresser where children may be tempted to use the drawers to climb.
- **ALWAYS** make sure your older CRT television does not hang over the edge of your furniture.



Declaration of Conformity

Trade Name	LG
Model	65EC9700-UA
Responsible Party	LG Electronics Inc.
Address	1000 Sylvan Ave. Englewood Cliffs NJ 07632 U.S.A
TEL	201 - 266 - 2534

The model and serial number of the TV are located on the back and one side of the TV. Record them below should you ever need service.

MODEL _____

SERIAL _____

LG Customer Information Center

For inquires or comments, visit www.lg.com or call;

1-800-243-0000	USA, Consumer User
1-888-865-3026	USA, Commercial User
1-888-542-2623	CANADA

Register your product Online!

www.lg.com