

**SAMSUNG**

DVD-E360

# DVD Player

## User Manual

imagine the possibilities

Thank you for purchasing this Samsung product.

To receive more complete service, please register your product at

[www.samsung.com/global/register](http://www.samsung.com/global/register)

**DVD** COMPACT  
VIDEO DISC  
DIGITAL AUDIO  
**ENGLISH**

# Getting Started

## Important Safety Instructions



Read these operating instructions carefully before using the unit. Follow all the safety instructions listed below. Keep these operating instructions handy for future reference.

- 1) Read these instructions.
- 2) Keep these instructions.
- 3) Heed all warnings.
- 4) Follow all instructions.
- 5) Do not use this apparatus near water.
- 6) Clean only with a dry cloth.
- 7) Do not block any ventilation openings. Install in accordance with the manufacturer's instructions.
- 8) Do not install near any heat sources such as radiators, heat registers, stoves, or other apparatus (including amplifiers) that produce heat.
- 9) Do not defeat the safety purpose of the polarized or grounding-type plug. A polarized plug has two blades with one wider than the other. A grounding type plug has two blades and a third grounding prong. The wide blade or the third prong are provided for your safety. If the provided plug does not fit into your outlet, consult an electrician for replacement of the obsolete outlet.
- 10) Protect the power cord from being tripped on or pinched particularly at plugs, convenience receptacles, and the point where they exit from the apparatus.
- 11) Only use attachments/accessories specified by the manufacturer.
- 12) Use only with cart, stand, tripod, bracket, or table specified by the manufacturer, or sold with the apparatus. When a cart is used, use caution when moving the cart/apparatus combination to avoid injury from tip-over.
- 13) Unplug this apparatus during lightning storms or when unused for long periods of time.
- 14) Refer all servicing to qualified service personnel. Servicing is required when the apparatus has been damaged in any way, such as the power-supply cord or plug is damaged, liquid has been spilled or objects have fallen into the apparatus, the apparatus has been exposed to rain or moisture, does not operate normally, or has been dropped.



## Precautions

TO REDUCE THE RISK OF ELECTRIC SHOCK, DO NOT REMOVE THE COVER (OR BACK).  
NO USER-SERVICEABLE PARTS ARE INSIDE. REFER SERVICING TO QUALIFIED SERVICE PERSONNEL.

	<b>CAUTION</b> RISK OF ELECTRIC SHOCK DO NOT OPEN	
The lightning flash and Arrowhead within the triangle is a warning sign alerting you of dangerous voltage inside the product.	<b>CAUTION:</b> TO REDUCE THE RISK OF ELECTRIC SHOCK, DO NOT REMOVE COVER (OR BACK) NO USER SERVICEABLE PARTS INSIDE. REFER SERVICING TO QUALIFIED SERVICE PERSONNEL.	The explanation point within the triangle is a warning sign alerting you of important instructions accompanying the product.

Do not install this equipment in a confined space such as a bookcase or similar unit.

**WARNING :** TO REDUCE THE RISK OF FIRE OR ELECTRIC SHOCK, DO NOT EXPOSE THIS APPARATUS TO RAIN OR MOISTURE.

### Note to CATV system installer :

This reminder is provided to call CATV system installer's attention to Article 820-40 of the National Electrical Code (Section 54 of Canadian Electrical Code, Part I) that provides guidelines for proper

grounding and, in particular, specifies that the cable ground shall be connected to the grounding system of the building as close to the point of cable entry as practical.

**Caution :** FCC regulations state that any unauthorized changes or modifications to this equipment may void the user's authority to operate it.

- Apparatus shall not be exposed to dripping or splashing and no objects filled with liquids, such as vases, shall be placed on the apparatus.
- If you plug this unit into a 240V ac outlet, make sure to use a suitable plug adapter.

### FCC NOTE (for U.S.A):

This equipment has been tested and found to comply with the limits for a Class B digital device, pursuant to Part 15 of the FCC rules. These limits are designed to provide reasonable protection against harmful interference in a residential installation. This equipment generates, uses and can radiate radio frequency energy and, if not installed and used in accordance with the instructions, may cause harmful interference to radio or television reception, which can be determined by turning the equipment off and on. The user is encouraged to try to correct the interference by one or more of the following measures.

- Reorient or relocate the receiving antenna.
- Increase the separation between the equipment and receiver.
- Connect this equipment into an outlet on a circuit different from that to which the receiver is connected.
- Consult the dealer or an experienced radio/TV technician for help.
- This class B digital product meets all requirements of the Canadian Interference - Causing Equipment Regulations.

### FDA Laser :

"Complies with 21CFR 1040.10 except for deviations pursuant to Laser Notice No. 50, dated June 24, 2007."

### CALIFORNIA USA ONLY :

This Perchlorate warning applies only to primary CR (Manganese Dioxide) Lithium coin cells in the product sold or distributed ONLY in California USA "Perchlorate Material - special handling may apply", See [www.dtsc.ca.gov/hazardouswaste/perchlorate](http://www.dtsc.ca.gov/hazardouswaste/perchlorate).

### CLASS 1 LASER product

This Compact Disc player is classified as a CLASS 1 LASER product. Use of controls, adjustments or performance of procedures other than those specified herein may result in hazardous radiation exposure.

### DANGER :

VISIBLE AND INVISIBLE LASER RADIATION WHEN OPEN. AVOID DIRECT EXPOSURE TO BEAM. (FDA 21 CFR).

### CAUTION

- CLASS 3B VISIBLE AND INVISIBLE LASER RADIATION WHEN OPEN. AVOID EXPOSURE TO THE BEAM (IEC 60825-1).
- THIS PRODUCT UTILIZES A LASER. USE OF CONTROLS OR ADJUSTMENTS OR PERFORMANCE OF PROCEDURES OTHER THAN THOSE SPECIFIED HEREIN MAY RESULT IN HAZARDOUS RADIATION EXPOSURE. DO NOT OPEN COVER AND DO NOT REPAIR YOURSELF. REFER SERVICING TO QUALIFIED PERSONNEL.

### Notes:

- This unit can be used only where the power supply is AC 120V, 60Hz. It cannot be used elsewhere.
- This DVD player is designed and manufactured to respond to the Region Management Information. If the Region number of a DVD disc does not correspond to the Region number of this DVD player, the DVD player cannot play the disc.
- The product unit accompanying this user manual is licensed under certain intellectual property rights of certain third parties. In particular, this product is licensed under the following US patents: 5,457,669 5,561,649 5,705,762 5,987,417 6,043,912 6,222,983 6,272,096 6,377,524 6,377,531 6,385,587 6,389,570 6,408,408 6,466,532 6,473,736 6,477,501 6,480,829 6,556,520 6,556,521 6,556,522 6,578,163 6,594,208 6,631,110 6,658,588 6,674,697 6,674,957 6,687,455 6,697,307 6,707,985 6,721,243 6,721,493 6,728,474 6,741,535 6,744,713 6,744,972 6,765,853 6,765,853 6,771,890 6,771,891 6,775,465 6,778,755 6,788,629 6,788,630 6,795,637 6,810,201 6,862,256 6,868,054 6,894,963 6,937,552.

This license is limited to private non-commercial use by end-user consumers for licensed contents. No rights are granted for commercial use. The license does not cover any product unit other than this product

CLASS 1	LASER PRODUCT
KLASSE 1	LASER PRODUKT
LUOKAN 1	LASER LAITE
KLASS 1	LASER APPARAT
PRODUCTO	LASER CLASE 1

unit and the license does not extend to any unlicensed product unit or process conforming to ISO/IEC 11172-3 or ISO/IEC 13818-3 used or sold in combination with this product unit. The license only covers the use of this product unit to encode and/or decode audio files conforming to the ISO/IEC 11172-3 or ISO/IEC 13818-3. No rights are granted under this license for product features or functions that do not conform to the ISO/IEC 11172-3 or ISO/IEC 13818-3.

#### Handling Cautions

- Do not write on the printed side with a ball-point pen or pencil.
- Do not use record cleaning sprays or antistatic sprays to clean discs. Also, do not use volatile chemicals, such as benzene or thinner.
- Do not apply labels or stickers to discs. (Do not use discs fixed with exposed tape adhesive or left over peeled-off stickers.)
- Do not use scratch-proof protectors or covers.
- Do not use discs printed on by label printers available on the market.
- Do not load warped or cracked discs.
- Before connecting other components to this player, be sure to turn them off.
- Do not move the player while it is playing a disc. The disc can be scratched or damaged and the player's internal parts can be damaged.
- Do not put a flower vase filled with water or any small metal objects on the player.
- Be careful not to put your hand into the disc tray.
- Do not place anything other than the disc in the disc tray.
- Interference from exterior sources such as lightning and static electricity can affect the normal operation of this player. If this occurs, turn the player off and on again with the POWER button, or disconnect and then reconnect the AC power cord to the AC power outlet. The player will operate normally.
- Be sure to remove the disc and turn off the player after use.
- Disconnect the AC power cord from the AC outlet when you don't intend to use the player for long periods of time.
- To clean a disc, wipe it in a straight line from the inside to the outside of the disc.
- Do not expose the player to any liquid.
- When the AC plug is connected to a wall outlet, the player will still draw power even when it is turned off. It is in standby mode.
- Do not expose the player to dripping or splashing. Do not put objects filled with liquids, such as vases, on the player.
- To turn off the player completely so that it draws no power, you must remove its power plug from the wall socket. Consequently, you should keep the player's power plug easily accessible at all times.
- Do not touch the power plug with a wet hand. It can cause an electric shock.
- Do not plug multiple electric devices into one socket. It can cause the socket to overheat, resulting in a fire. If the player produces an abnormal noise, a burning smell, or smoke, turn off the power switch immediately and disconnect the power plug from the wall outlet. Then, contact the nearest customer center for technical assistance. If you continue to use the product, it may cause an electric shock or fire.
- The Mains plug is used as a disconnect device and shall stay readily operable at any time.
- To reduce the risk of fire or electric shock, do not expose this appliance to rain or moisture.

#### Disc Storage

- Be careful not to damage the disc because the data on these discs is highly vulnerable to the environment.
- Do not keep under direct sunlight.
  - Keep in a cool, ventilated area.
  - Store vertically.
  - Keep in a clean protection jacket.
  - If you move your player suddenly from a cold place to a warm place, condensation may occur on the operating parts and lens and cause abnormal disc playback. If this occurs, unplug the player, wait for two hours, and then connect the plug to the power outlet. Then, insert the disc, and try to play back again.

#### Maintenance of Cabinet

- For safety reasons, be sure to disconnect the AC power cord from the AC outlet before cleaning.
- Do not use benzene, thinner, or other solvents for cleaning.
  - Wipe the cabinet with a soft cloth.

#### Accessories

- Remote Control (AK59-00156A)
- Batteries for Remote Control (AAA Size) (AC43-12002H)
- User's Manual (AK68-02218A)
- Video/Manual Cable (AC39-42001U & AC39-22017Z)

## Contents

<b>GETTING STARTED</b>	
Precautions.....	2
General Features .....	3
Description .....	4
Tour of the Remote Control .....	5
<b>CONNECTIONS</b>	
Choosing a Connection.....	5
Connecting to a TV Using the Video Jack (Video) ..	5
Connecting to a TV Using the Component Jacks (Progressive/Interface) .....	5
Connecting to an Audio System (2 Channel, Dolby Digital or MPEG2).....	6
<b>BASIC FUNCTIONS</b>	
Playing a Disc.....	6
Using the Search and Skip Functions .....	6
Using the Tool Button Display Function .....	6
Using the Disc and Title Menu .....	7
Repeat Play .....	7
Slow Play .....	7
<b>ADVANCED FUNCTIONS</b>	
Adjusting the Aspect Ratio (EZ View).....	7
Selecting the Audio Language .....	8
Selecting the Subtitle Language .....	8
Changing the Camera Angle.....	8
Using the Bookmark Function.....	8
Using the Zoom Function.....	8
Clips Menu for MP3/WMA/JPEG/MPEG4/CD Audio .....	8
Folder Selection .....	8
MP3/WMA/CD Audio Playback.....	9
MPEG4 Playback .....	9
Playing Media Files using the USB HOST feature .....	10
CD Ripping .....	10
Picture CD Playback .....	11
<b>NAVIGATING THE SETUP MENU</b>	
Using the Setup Menu .....	11
Setting Up the Display Options.....	11
Setting Up the Audio Options .....	12
Setting Up the Language Features.....	12
Setting Up the Security Options.....	12
Setting Up the General Options .....	13
Setting Up the Support Options.....	13
<b>REFERENCE</b>	
Firmware upgrade .....	13
Troubleshooting.....	14
Specifications .....	14

## General Features

### Excellent Sound

Dolby Digital, a technology developed by Dolby Laboratories, provides crystal clear sound reproduction.

### Screen

You can view video in both regular (4:3) and wide-screen (16:9).

### Slow Motion

You can watch scenes in slow motion.

### Parental Control (DVD)

The parental control function allows you to set the level necessary to prevent children from viewing harmful movies such as those with violence, adult subject matter, etc.

### Various On-Screen Menu Functions

You can select various languages (Audio/Subtitle) and screen angles while enjoying movies.

### Progressive Scan

Progressive scan provides an improved picture with double the scan lines of a conventional inter-

laced picture.

### EZ View (DVD)

Easy View lets you adjust the picture to match your TV's screen size (16:9 or 4:3).

### Digital Photo Viewer (JPEG)

You can view Digital Photos on your TV.

### Repeat

You can repeat a song or movie simply by pressing the REPEAT button.

### MP3/WMA

This unit can play discs created from MP3/WMA files.

### MPEG4

This unit can play MPEG4 formats within an avi file.

### CD Ripping

This feature converts audio files on a disc into the MP3 format and then stores them on a USB device. (Audio CD only CD DA).

## Note

- These disc formats cannot be played on this player.
  - DVD-ROM • DVD-RAM
  - CD-ROM
    - CDV
    - CVD
  - CDI
- The ability to play back the following disc formats may depend on recording conditions.
  - DVD-R, +R
  - CD-RW
  - DVD+RW, -RW (V mode)
- The unit may not play certain CD-R, CD-RW and DVD-R due to the disc type or recording conditions.







## COPY PROTECTION

Many DVD discs are encoded with copy protection. Because of this, you should only connect your DVD player directly to your TV, not to a VCR. Connecting to a VCR results in a distorted picture from copy-protected DVD discs. This item incorporates copy protection technology that is protected by U.S. patents and other intellectual property rights of Rovi Corporation. Reverse engineering and disassembly are prohibited.

## PROGRESSIVE SCAN OUTPUTS (480p)

YOU SHOULD NOTE THAT NOT ALL HIGH DEFINITION TELEVISION SETS ARE FULLY COMPATIBLE WITH THIS PRODUCT AND MAY CAUSE ARTIFACTS TO BE DISPLAYED IN THE PICTURE. IF PROGRESSIVE SCAN PICTURE PROBLEMS OCCUR, WE RECOMMEND THAT YOU SWITCH THE CONNECTION TO THE 'STANDARD DEFINITION' (VIDEO) OUTPUT. IF THERE ARE QUESTIONS REGARDING YOUR TV SET'S COMPATIBILITY WITH THIS DVD PLAYER, PLEASE CONTACT SAMSUNG'S CUSTOMER SERVICE CENTER.

## Disc Markings

	Play Region Number
	NTSC broadcast system in U.S.A, Canada, Korea, Japan, etc.
	Dolby Digital disc
	Stereo disc
	Digital Audio disc
	MP3 disc

## Region Number

Both the DVD Player and your DVD discs are coded by region. These regional codes must match in order for the disc to play. If the codes do not match, the disc will not play. The Region Number for this player is displayed on the rear panel of the player.

## Description

### Front Panel Controls

DVD-E360



- 1. DISC TRAY**  
Place the disc here.
- 2. DISPLAY**  
Operation indicators are displayed here.
- 3. OPEN/CLOSE (▲)**  
Press to open and close the disc tray.
- 4. PLAY/PAUSE (▶||)**  
Begin or pause disc play.
- 5. POWER ON/OFF (⏻)**  
Turn On/Off the DVD Player.
- 6. USB HOST**  
Connect a digital still camera, MP3 player, memory stick, Card reader or other removable storage devices.

### Rear Panel

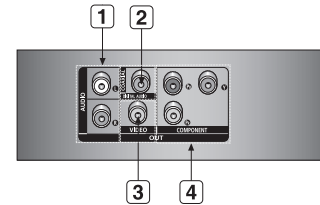

- 1. AUDIO OUT JACKS**
  - Use audio cables to connect to the Audio input jacks of your television or audio/video receiver
- 2. DIGITAL AUDIO JACK**
  - Use a coaxial digital cable to connect to a Dolby Digital receiver or A/V Amplifier that contains a Dolby Digital, MPEG2, or DTS decoder.
- 3. VIDEO OUT JACK**
  - Use a video cable to connect to the Video input jack on your television.
- 4. COMPONENT VIDEO OUT JACKS**
  - Use these jacks if you have a TV with Component Video in jacks. These jacks provide P<sub>R</sub>, P<sub>B</sub> and Y video.
  - If P-SCAN is set to "ON" in Video Output of the General Menu, progressive scan mode will work.
  - If I-SCAN is set to "ON" in Video Output of the General Menu, interlaced scan mode will work.

## Tour of the Remote Control

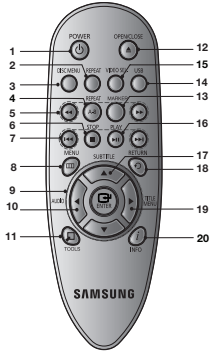

- 1. DVD POWER Button**  
Turns the power on or off.
- 2. REPEAT Button**  
Allows you to repeat play a title, chapter, track, or disc.
- 3. DISC MENU Button**  
Brings up the Disc menu.
- 4. REPEAT A-B Button**  
Allows you to repeat a chosen section (A-B) on a disc.
- 5. SEARCH Buttons (◀/▶)**  
Allows you to search forward/backward through a disc.
- 6. STOP Button (■)**  
To stop the disc
- 7. SKIP Buttons (◀/▶)**  
Use to skip the title, chapter or track.
- 8. MENU Button**  
Brings up the DVD player's menu.

### 9. ENTER/▲/▼,◀/▶ Buttons

This button functions as a toggle switch.

### 10. AUDIO Button (◀)

Use this button to access various audio functions on a disc. Use this button to select an available TV source (mode TV).

### 11. TOOLS Button

Displays the current disc mode. It also lets you access the Display function.

### 12. OPEN/CLOSE (▲) Button

To open and close the disc tray.

### 13. MARKER

Quickly find bookmark sections of a DVD.

### 14. USB Button

To change device which access to USB device.

### 15. VIDEO SEL. Button

Changes video output mode.

### 16. PLAY Button (▶)

Begins disc play.

### 17. SUBTITLE/(▲) Button

### 18. RETURN Button

Returns to a previous menu.

### 19. TITLE MENU Button (▶)

Brings up the Title menu.

### 20. INFO Button

Displays the current playback information.

### Install Batteries in the Remote Control

1. Open the battery cover on the back of the remote control.
2. Insert two AAA batteries. Make sure that the polarities (+ and -) are aligned correctly.
3. Replace the battery cover.

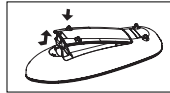

## Connections

### Choosing a Connection

The following text explains how to make connections commonly used to connect the DVD player with a TV and other components. A diagram showing these connections is to the right.

#### Before Connecting the DVD Player

- Always turn off the DVD player, TV, and other components before you connect or disconnect any cables.
- Refer to the user's manual of the components (such as a TV) you are connecting for more information on those particular components.

#### Notes

- The first time you turn on your DVD player, the Language Selection screen appears. See **Selecting a Language on page 6** for details.

#### A. Connecting to a TV Using the Video Jack (Video)

1. Using Video/Audio cables, connect the **VIDEO (yellow)/AUDIO (red and white) OUT** jacks on the rear of the DVD player to the **VIDEO (yellow)/AUDIO (red and white) IN** jacks of your TV.
2. Turn on your DVD player and TV.
3. Press the input selector button on your TV remote control until the Video signal from the DVD player appears on the TV screen.

#### B. Connecting to a TV Using the Component Jacks (Progressive/ Interlace)

- Connecting through the Component jacks lets you view video at the 480p (Progressive Scan) resolution.
- What is "Progressive Scan"?
- Progressive scan has twice as many scanning lines per frame as interlaced (480i) output and provides better and clearer picture quality.

1. Using Component video cables (not included), connect the **COMPONENT VIDEO OUT** (PR, PB and Y) jacks on the rear of the DVD player to the **COMPONENT IN** (PR, PB and Y) jacks of your TV.
2. Using the audio cables, connect the **AUDIO (red and white) OUT** jacks on the rear of the DVD player to the **AUDIO (red and white) IN** jacks of your TV. Turn on the DVD player and TV.
3. Set the Video Output to **P-SCAN/I-SCAN** in the Display Setup menu. You can also use the **VIDEO SEL.** button to change the Video Output mode.
4. Press the input selector button on your TV remote control until the Component signal from the DVD player appears on the TV screen.

#### Notes

- **Noise may be generated if the audio cable is placed too close to the power cable.**
- If you want to connect to an Amplifier, please refer to the Amplifier connection section below.
- The number and position of the jacks on your TV may vary depending on your TV set. Please refer to the user's manual of your TV.
- If there is one audio input terminal on the TV, connect it to the [AUDIO OUT] [left] (white) jack of the DVD player.
- If you press the VIDEO SEL. button when the DVD Player is in stop mode or no disc is inserted, the Video Output mode changes in the following sequence : I-SCAN → P-SCAN (Interlaced → Progressive).

### C. Connecting to an Audio System (2 Channel, Dolby Digital, or MPEG2)

1. Using the audio cables, connect the **AUDIO (red and white) OUT** jacks on the rear of the DVD player to the **AUDIO (red and white) IN** jacks of the Amplifier. If using a Coaxial cable, connect the **DIGITAL AUDIO (COAXIAL)** jack on the rear of the DVD player to the **DIGITAL AUDIO IN (COAXIAL)** jack of the Amplifier.
2. Using the video signal cable(s), connect the **COMPONENT** or **VIDEO OUT** jacks on the rear of the DVD player to the **COMPONENT** or **VIDEO IN** jacks of your TV.
3. Turn on your DVD player, TV, and Amplifier.
4. Press the input select button of the Amplifier to select the audio input your DVD player is connected to in order to hear sound. Refer to your Amplifier's user manual to set the Amplifier's audio input.

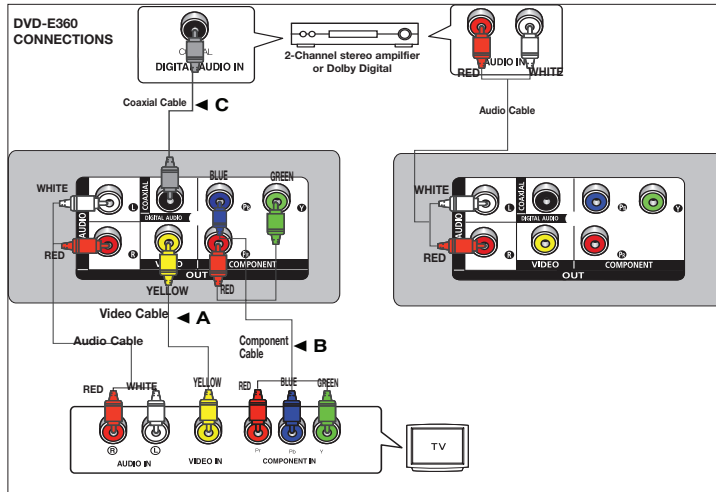

## Basic functions

### Playing a Disc

#### Before Play

- Using your TV's remote control, turn on your TV and set it to the Video Input your DVD player is connected to.
- If you connected the DVD player to an external Audio System, turn on your Audio System and set it to the correct Audio Input.

#### Selecting a Language

After plugging in the player, the first time you press the DVD **POWER** button, the screen to the right appears. If you want to select a language, press the **▲/▼** button, and then press the **ENTER** button. (This screen will only appear when you plug in the player for the first time.) If you do not set the language on this screen, the settings may change whenever you turn the power on or off. Therefore, make sure that you select the language you want to use.

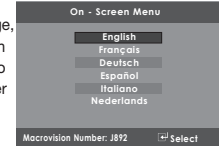

Once you select a menu language, you can change it by pressing the **▶|I** button on the front panel of the unit for more than 5 seconds with no disc in the unit. The **SELECT MENU LANGUAGE** window appears again and you can reset to your preferred language.

### Using the Search and Skip Functions

During play, you can search quickly through a chapter or track, and use the skip function to jump to the next selection.

#### Searching through a Chapter or Track

During play, press the **SEARCH** (**◀◀** or **▶▶**) button on the remote control for more than 1 second

- If you want to search at a faster speed on the DVD or CD, press the **SEARCH** button.

DVD	2X, 4X, 8X, 16X, 32X
CD	2X, 4X, 8X, 16X, 32X

#### Notes

- The speed marked in this function may be different from the actual playback speed.
- No sound is heard during search mode (Except CD).

#### Skipping Tracks

During play, press the **SKIP** (**◀◀** or **▶▶**) button.

- When playing a DVD, if you press the **SKIP** (**▶▶**) button, it moves to the next chapter. If you press the **SKIP** (**◀◀**) button, it moves to the beginning of the chapter. Pressing the **Skip** (**◀◀**) button twice makes the DVD move to the beginning of the previous chapter.
- When playing a CD, if you press the **SKIP** (**▶▶**) button, it moves to the next track. If you press the **SKIP** (**◀◀**) button, it moves to the beginning of the track. Pressing the **Skip** (**◀◀**) button twice makes the CD move to the beginning of the previous track.









### Using the Tool Button Display Functions

#### When Playing a DVD/MPEG4

1. During play, press the **TOOLS** button on the remote control.
2. Press the **▲/▼** buttons to select the desired item.

- Press the ◀/▶ buttons to make the desired setup.
- To make the screen disappear, press the **TOOLS** button again.

The Tool Button Display functions are listed in the table below.

	To access the desired title when there is more than one in the disc. For example, if there is more than one movie on a DVD, each movie will be identified.
	Most DVD discs are recorded in chapters (similar to tracks on an audio CD). Select this function to find and play a specific chapter.
	Allows playback of the film from a desired time. You must enter the starting time as a reference. The time search function does not operate on some discs.
	Lets you select the soundtrack language for a film. A DVD disc can have up to eight different soundtracks.
	Lets you select the subtitle language or, if you prefer, turn off subtitles. A DVD disc can have up to 32 different sets of subtitles, each in a different language.
	Lets you choose the EZ-View type
	Select to activate the Zoom function.
	Some DVDs have scenes that have been recorded at multiple angles. Use the Angle function to view a scene at one of those angles.

## Using the Disc and Title Menu

During playback of a DVD disc, press the **DISC MENU** button to view the Disc Menu. Press the **TITLE MENU** button to view the TITLE Menu.

### Notes

- Depending on the disc, the Disc Menu or Title Menu may not work.
- The Title Menu will only be displayed if there are at least two titles on the disc.

## Repeat Play

Repeat the current track, chapter, title, a chosen section (A-B), or all of the disc.

### When playing a DVD

- Press the **REPEAT** button on the remote control. The repeat screen appears.
- Press the **REPEAT** or ▲/▼ button to change the playback mode. You can select one of the following modes:
  - Off
  - Title: Repeats the title that is playing.
  - Chapter: Repeats the chapter that is playing.
  - Repeat A-B

### Using the A-B Repeat function

- Press the **REPEAT A-B** button on the remote control.
  - Press the **REPEAT A-B** at the point where you want repeat play to start (A).
  - Press the **REPEAT A-B** at the point where you want repeat play to stop (B).
- To return to normal play, press the **REPEAT** button until the display shows Repeat : Off.

### Notes

- A-B REPEAT allows you to set point (B) directly after you have set point (A).
- Depending on the disc, the Repeat function may not work.

## Slow Play

This feature allows you to repeat scenes containing sports, dancing, musical instruments being played etc. in slow motion, so you can study them more closely.

### When playing a DVD

- During play, press the **PLAY** (▶||) button.
- Press the **SEARCH** (◀/▶) button to choose the play speed between 1/2, 1/4, 1/8 and 1/16 of normal speed.

## Advanced functions

### Adjusting the Aspect Ratio (EZ View)

The Aspect ratio is the relation between the width and height of a picture. The two most common are 4:3 (Standard) and 16:9 (Widescreen). Follow the instructions below for the best aspect ratio setting for your TV.

### Changing the Aspect Ratio (DVD)

- During play, press the **TOOLS** button on the remote control.
- Press the ▲/▼ buttons to select  icon. Each time you press the ◀/▶ buttons, the screen size changes. For graphics of the screen sizes and the sequence in which the sizes change, see below.
- Press the **RETURN** button to exit EZ View.

#### - 4:3 Letter Box



#### - 4:3 Pan&Scan



#### - 16:9 Wide



### If you are using a 16:9 TV

#### For 16:9 aspect ratio discs

- WIDESCREEN
- SCREEN FIT
- ZOOM FIT

#### For 4:3 aspect ratio discs

- Normal Wide
- SCREEN FIT
- ZOOM FIT
- Vertical Fit

### If you are using a 4:3 TV

#### For 16:9 aspect ratio discs

- 4:3 Letter Box
- 4:3 Pan&Scan
- SCREEN FIT
- ZOOM FIT

#### For 4:3 aspect ratio discs

- Normal Screen
- SCREEN FIT
- ZOOM FIT

### Note

This function may behave differently depending on the type of disc.

## Selecting the Audio Language

You can select a desired audio language available on a disc quickly and easily with the AUDIO button.

### Using the AUDIO (◀) Button (DVD/MPEG4)

1. During play, press the **AUDIO** (◀) button. Change the audio language by pressing the ▲/▼ button.
  - The audio languages are represented by abbreviations.
2. To remove the **AUDIO** icon from the screen, press the **RETURN** button

#### Notes

- This function depends on the audio languages that are encoded on the disc. This function may not work with all DVDs.
- A DVD disc can contain up to 8 audio languages.

## Selecting the Subtitle Language

You can select a desired subtitle language quickly and easily with the SUBTITLE button.

### Using the SUBTITLE (▲) Button (DVD)

1. During play, press the **SUBTITLE** (▲) button.
2. Press the **SUBTITLE** (▲) button to change the language. Each time you press the **SUBTITLE** (▲) or ▲/▼ buttons, the language changes.
3. Press the **RETURN** button to exit the Subtitle function.

#### Notes

- The subtitle languages are represented by abbreviations.
- Depending on the DVD, you may have to select the desired subtitle language in the DVD's Disc Menu. Press the INFO button.
- This function depends on which subtitle languages are encoded on the disc. This function may not work with all DVDs.
- A DVD disc can contain up to 32 subtitle languages.

## Changing the Camera Angle

When a DVD contains multiple angles of a particular scene, you can use the ANGLE function.

### Using the ANGLE function (DVD)

If a scene contains multiple angles, the ANGLE mark appears on the screen.

1. During play, press the **TOOLS** button on the remote control.
2. Press the ▲/▼ buttons to select . When the angle screen is displayed, press the ◀/▶ buttons on the remote control to select the desired angle option.

## Using the Bookmark Function

This feature lets you bookmark sections of a DVD, so you can quickly find them at a later time.

### Using the Bookmark Function (DVD)

1. During play, press the **MARKER** button on the remote control.
2. When you reach the scene you want to mark, press the ◀/▶ or ▲/▼ buttons, and then press the **MARKER** button. You can bookmark up to 12 scenes at a time.

#### Note

- Depending on the disc, the Bookmark function may not work.

## Recalling a Marked Scene

1. During play, press the **MARKER** button on the remote control.
2. Press the ◀/▶ or ▲/▼ buttons to select a marked scene.
3. Press the **PLAY** (▶) button to skip to the marked scene.

## Clearing a Bookmark

1. During play, press the **MARKER** button on the remote control.
2. Press the ◀/▶ or ▲/▼ buttons to select the bookmark number you want to delete.
3. Press the **ENTER** button to delete a bookmark number.

## Using the Zoom Function

### Using the Zoom Function (DVD)

1. During play, press the **TOOLS** button on the remote control.
2. Press the ▲/▼ buttons to select  icon, and then press the **ENTER** button to zoom in X1, X2, X3, X4.

## Clips Menu for MP3/WMA/JPEG/MPEG4/CD Audio

CD Audio or discs with MP3/WMA/JPEG/MPEG4 files contain individual songs and/or pictures. The player organizes these discs into folders that contain only one content type (for example, only pictures, only music, etc.). The folders function much like the folders you use on your computer. To go access these folders and the files in them, follow these steps :

1. Open the disc tray. Place the disc on the tray.
2. Close the tray. The tray closes and the Parent Folder Menu screen appears (top screen image.) Parent folders contain all the Peer folders that have the same kind of content: Videos, music, photos, etc.
3. Press the ◀/▶ buttons to select the Parent folder of your choice (Video, Photos, or Music) and then press **ENTER**. A screen displaying the Peer folders appears.

The Peer folders contain all the folders with the same kind of content (videos, music, photos, etc.) that are in the Parent folder.



#### Notes

- While the screen will display folders for all content types, only the files of the content type you selected will be visible when you open a folder. For example, if you selected Photos, only photo files in the Pictures Peer folder will be visible. Music files and Video files will be invisible and inaccessible. To view music or video files, you must return to the Parent Folder Menu screen and select either Videos or Music.

## Folder Selection

You can select a folder both in Stop or Play mode.

- **To select a Parent Folder**  
Press the **RETURN** button to go to the parent folder, or press the ▲/▼ buttons to select ".." and then press **ENTER** to go to the parent folder.
- **To select a Peer Folder**  
Press the ▲/▼ buttons to select the desired folder, and then press **ENTER**.
- **To select a Sub-Folder**  
Press the ▲/▼ buttons to select the desired folder, and then press **ENTER**.



## MP3/WMA/CD Audio Playback

1. Open the disc tray. Place the disc on the tray. Close the tray.
2. Press the ◀/▶ buttons to select a Music folder, and then press **ENTER**. Press the ▲/▼ to select a song file, and then press **ENTER**. Press ▲/▼ to begin playback of the song file, and then press the **ENTER** button.

### Repeat/Random playback

1. Press the **REPEAT** button to change the playback mode. There are four modes; **Off**, **Track**, **Folder** and **Random**.
  - Off (⇐⇒) : Normal Playback
  - Track (□) : Repeats the current song file.
  - Folder (■) : Repeats the song files which have the same extension in the current folder.
  - Random (⇄) : Plays the song files which have the same extension in random order.
2. To resume normal play, press the **REPEAT** button until you have selected Repeat : Off.

### CD-R MP3/WMA file

When you record MP3 or WMA files on a CD-R for playback in this unit, please note the following:

- **Your MP3 or WMA files should be in ISO 9660 or JOLIET format.**  
ISO 9660 format and Joliet MP3 or WMA files are compatible with Microsoft's DOS and Windows, and with Apple's Mac. This format is the most widely used.
- **When naming your MP3 or WMA files, do not exceed 8 characters, and enter ".mp3, or .wma" as the file extension.**  
General name format : Title.mp3. or Title.wma. When composing your title, make sure that you use 8 characters or less, have no spaces in the name, and avoid the use of special characters including: (.,/\,=,+).
- **Use a decompression transfer rate of at least 128 Kbps when recording MP3 files.**  
The sound quality of MP3 files depends on the rate of compression/decompression you choose. To get good MP3 CD audio sound requires an analog/digital sampling rate of at least 128 Kbps, but not more than 160 Kbps. Choosing higher rates, such as 192 Kbps or more, only rarely gives better sound quality. MP3 Files with decompression rates below 128 Kbps will not play properly.
- **Use a decompression transfer rate of at least 64Kbps when recording WMA files.**  
The sound quality of WMA files depends on the rate of compression/decompression you choose. To get good WMA CD audio sound requires an analog/digital sampling rate of at least 64 Kbps, but not more than 192 Kbps. WMA files with compression rates below 64 Kbps or above 192 Kbps will not play properly. WMA files only support sampling rates > 30 KHz.
- **Do not try recording copyright protected MP3 files.**  
Windows Media™ files (a registered trade mark of Microsoft Inc) and SDMI™ files (a registered trade mark of the SDMI Foundation) are encrypted and code protected to prevent illegal copying. You cannot copy these files.
- **Important:**  
The recommendations above cannot be taken as a guarantee that the DVD player will play MP3 recordings, or as an assurance of sound quality. You should note that certain technologies and methods for MP3 file recording on CD-Rs prevent optimal playback of these files on your DVD player (degraded sound quality and in some cases, inability of the player to read the files).
- This unit can play a maximum of 500 files and 500 folders per disc.

## MPEG4 Playback

### MPEG4 Play Function

The MPEG4 audio and video data compatible with this player are contained in AVI files. This unit can only play AVI format files with an ".avi" extension.

1. Open the disc tray. Place the disc on the tray. Close the tray.
2. Press the ◀/▶ buttons to select a Video Menu, and then press the **ENTER**. Press the ▲/▼ to select an avi file, and then press the **ENTER** button.

### Repeat and Repeat A-B playback

1. Press the **REPEAT** button, and then press **REPEAT** or ▲/▼ buttons to change playback mode. There are 3 modes:
  - Off: No Repeat mode.
  - Title: Repeats the title that is playing.
  - Folder: Repeats the AVI files which have the same extension in the current folder.
  - Repeat A-B.

### Repeat A-B playback

1. Press the **REPEAT A-B** button on the remote control.
  2. Press the **REPEAT A-B** button at the point where you want repeat play to start (A).
  3. Press the **REPEAT A-B** button at the point where you want the repeat play to stop (B)
- To return to normal play, press the **REPEAT A-B** button until the display shows Repeat : Off.

### Note

A-B REPEAT allows you to set point (B) directly after point (A) has been set.

### MPEG4 Function Description

Function	Description
Skip ( ◀◀ or ▶▶ )	During play, press the  ◀◀ or ▶▶  button to move to next or previous track.
Search (◀◀ or ▶▶)	During play, press the SEARCH (◀◀ or ▶▶) button. Press again to search at a faster speed. (2X, 4X, 8X, 16X, 32X)
Slow Motion Play	During play, press the <b>PLAY</b> (▶  ) button, and then press the <b>SEARCH</b> (▶▶) button to view video at a slower speed. (1/2, 1/4, 1/8, 1/16).
ZOOM	X1, X2, X3, X4, Normal, in that order.

- These functions may not work depending, on the MPEG4 file.

### Note

- The DVD-E360 can support the following resolutions: Up to 720 x 480 @ 30 frames per second and 720 x 576 @ 25 frames per second.
- This unit supports CD-R/RW written in MPEG4 in accordance with the "ISO9660 format".

## Playing Media Files Using the USB Host feature

You can enjoy media files such as pictures, movies, and music saved in an MP3 player, USB memory stick or digital camera by connecting them to the USB port of the DVD Player.

### Using the USB HOST Feature

1. Connect the USB device to the USB port on the front of the unit.
2. The USB Menu screen appears. Press the ◀▶ button to select Menu, and then press **ENTER**.
3. Press the ▲/▼ buttons to select a file in the USB device. Press **ENTER** to open the file.



### Switching Between DVD and USB

If you have a disk in the player, and you are viewing or listening to files on a USB device, or the USB Menu is on the screen, you can switch from the USB device to the disc by pressing the USB button on the remote.

Also, you can switch from the disc to the USB device by pressing the USB button on the remote. "USB loading..." appears on the screen, and then the USB Menu appears.

### Notes

- Depending on the file size and clip duration, loading time for a USB device may take longer than a CD or DVD.

### Safe USB Removal

1. Press the USB button to return to disc mode or the main screen.
2. Press the STOP (■) button
3. Remove the USB cable/device.

### Skip Forward/Back

During playback, press the (◀▶) button.

- If there is more than one file, when you press the ▶▶ button, the next file is selected.
- If there is more than one file, when you press the ◀◀ button, the previous file is selected.

### Fast playback

To play back the disc at a faster speed, press (◀▶) during playback.

- Each time you press either button, the playback speed will change as follows : 2X → 4X → 8X → 16X → 32X.

### Compatible Devices

- USB devices that support USB Mass Storage v1.0. USB devices that operate as a removable disk in Windows (2000 or later) without additional driver installation.
- MP3 Player: Flash type MP3 player.
- Digital camera: Cameras that support USB Mass Storage v1.0.
  - Cameras that operate as a removable disk in Windows (2000 or later) without additional driver installation.
- USB Flash Drive: Devices that support USB 2.0 or USB 1.1.
  - You may experience a difference in playback quality when you connect a USB 1.1 device.
- USB card Reader: One slot USB card reader and Multi slot USB card reader.
  - Depending on the manufacturer, the USB card reader may not be supported.
  - If you install multiple memory devices into a multi card reader, you may experience problems.
- If you use a USB extension cable, the USB device might not be recognized.

### Note

- CBI (Control/Bulk/Interrupt) is not supported.
- Digital Cameras that use the PTP protocol or require you to install a program to transfer files to your PC are not supported.
- Devices using the NTFS file system are not supported. Only FAT 16/32 (File Allocation Table 16/32) file systems are supported.
- Some MP3 players, when connected to this product, may not operate depending on the sector size of their file system.
- Devices that transfer media files using only their manufacturer-specific programs are not supported.
- The USB HOST function on this player does not support Janus enabled MTP (Media Transfer Protocol) devices.
- The USB host function of this product does not support all USB devices.
- The USB Host function on this player does not support USB Hard Disc Drives (HDD).

## CD Ripping

This feature lets you copy audio files from a CD onto a USB device in MP3 format.

1. Open the disc tray. Place the Audio CD (CD DA) disc on the tray, and then close the tray. Connect the USB device to the USB port on the front of the unit. Press the **USB** button.
2. Press the **TOOLS** button to display the Ripping screen.
3. Press the ▲/▼ buttons, then press the **ENTER** button to select a file for ripping.
  - To deselect a file, highlight the file, and then press the **ENTER** button again.
4. Press the ◀ and ▼ button to select **START**, and then press the **ENTER** button to begin ripping. The Ripping menu contain the following buttons:
  - **Mode** (Fast/Normal)
  - **Bitrate**. Press ENTER to change : 128kbps → 192kbps → 128kbps .
    - Standard : 128kbps
    - Better Quality : 192kbps
  - **Device selection**. Press **ENTER** to change between partitions on the USB device (max 4).
  - **Select - Unselect**. Press **ENTER** to change from Select all (files) or Select none.

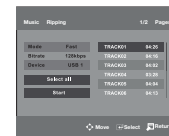

#### Notes

- To cancel copying in progress, press the **ENTER** button.
- To return to the CDDA screen, press the **TOOLS** button again.
- While the CD is being ripped, the player will automatically enter Stop mode.
- The ripping process is 2.6 times normal speed.
- The DVD player can only rip Audio CD (CD DA) discs.
- The USB button does not work while you're in the Ripping menu.
- CD ripping function may not supported for some MP3 players device.

### Picture CD Playback

1. Select the desired folder.
2. Press the **▲/▼** buttons to select a Picture file in the clips menu, and then press the **ENTER** button.

#### Notes

- When the **STOP** or **RETURN** button to return to the clips menu.
- When playing a Kodak Picture CD, the unit displays the Photo directly, not the Clips menu.

#### Rotation

- Press the **TOOLS** button to select Rotate, and then press **ENTER** button.
- Each time the **◀/▶** buttons are pressed, the picture rotates 90 degrees clockwise.
- Each time the **▲** button is pressed, the picture will turn upside down to show a mirror image.
- Each time the **▼** button is pressed, the picture will reverse to the right side to show a mirror image.

#### Zoom

- Press the **TOOLS** button to select Zoom, and then press **ENTER** button.
- Each time you press the **ENTER** button, the picture is enlarged. Zoom mode : X1-X2-X3-X4-X1.
- Press the **◀/▶/▲/▼** buttons to move the enlarged picture so you can view different portions.

#### Slide Show

- If you press **PLAY** when viewing a JPEG file, the DVD player goes to full screen mode and the slide show automatically starts.

#### Notes

- Depending on the file size, the amount of time each picture takes to load may be different.
- If you don't press any button, the slide show starts automatically in about 8 seconds.

#### CD-R JPEG Disc

- Only files with the ".jpg" and ".JPG" extensions can be played.
- If the disc has not been closed during the recording phase,(ie has not been finalised) it will take longer to start playing and not all of the recorded files may be played.
- Only CD-R discs with JPEG files in ISO 9660 or Joliet format can be played.
- The name of the JPEG file may not be longer than 8 characters and should contain no blank spaces or special characters (. / = +).
- Only a consecutively written multi-session disc can be played. If there is a blank segment in the multi-session disc, the disc can be played only up to the blank segment.
- A maximum of 500 images can be stored on a single CD.
- Kodak Picture CDs are recommended.
- When playing a Kodak Picture CD, only the JPEG files in the pictures folder can be played.
- Kodak Picture CD: The JPEG files in the pictures folder can be played automatically.

- Konica Picture CD: If you want to see the Picture, select the JPEG files in the clips menu.
- Fuji Picture CD: To see pictures, select the JPEG files in the clips menu.
- QSS Picture CD: The unit may not play a QSS Picture CD.
- If the number of files in one Disc is over 500, only 500 JPEG files can be played.
- If the number of folders in one Disc is over 500, only JPEG files in 500 folders can be played.

## Navigating the setup menu

### Using the Setup Menu

The Setup menu lets you customize your DVD player by allowing you to select various language preferences, set up the parental level, and even adjust the player to the type of television screen you have.

1. With the unit in Stop mode, press the **MENU** button on the remote control. Press the **◀/▶** buttons to select **SETTINGS**, and then press the **ENTER** button.
2. Press the **▲/▼** buttons to select a Setup Menu, and then press the **▶** or **ENTER** button to bring up the sub-menu.
3. Press the **▲/▼** buttons to select a sub-menu option, and then press the **▶** or **ENTER** button.
4. To make the Setup screen disappear after setting up, press the **RETURN** button.

#### Setup Menu Options

- **Display Setup:** Setup the Display Options. Use to select the screen aspect ratio you want and several display options.
- **Audio Setup:** Setup the Audio Options.
- **Language Setup:** Setup the Language.
- **Security Setup:** Setup the Parental Level. Allows users to set the level necessary to prevent children from viewing unsuitable movies such as those with violence, adult subject matter, etc.
- **General Setup:** Setup the General Options.
- **Support Setup:** Setup the Support Options.

#### Notes

Depending on the disc, some Setup menu selections may not work.

### Setting Up the Display Options

Display Setup options let you to set various video functions of the player.

1. With the unit in Stop mode, press the **MENU** button. Press the **◀/▶** buttons to select **SETTINGS**, and then press the **ENTER** button.
2. Press the **▲/▼** buttons to select **DISPLAY**, and then press the **▶** or **ENTER** button.
3. Press the **▲/▼** buttons to select the desired item, and then press the **▶** or **ENTER** button.

- **Consult your TV User's Manual to find out if your TV supports Progressive Scan. If Progressive Scan is supported, follow the instruction in the TV User's Manual regarding Progressive Scan settings in the TV's menu system.**
- **If Video Output is set incorrectly, the TV screen may be blank.**

Each option in the Display Setup Menu is described starting below.

#### TV Aspect

- Depending on a type of television you have, you may want to adjust the screen setting (aspect ratio).
  - **4:3 Pan & Scan** : Select this for conventional size TVs when you want to see the central portion of the 16:9 screen. (Extreme left and right side of movie picture will be cut off.)

- **4:3 Letter Box** : Select when you want to see the total 16:9 ratio screen the DVD supplies, even though you have a TV with a 4:3 ratio screen. Black bars will appear at the top and bottom of the screen.
- **16:9 Wide** : To view the full 16:9 picture on your widescreen TV.

## Setting Up the Audio Options

Audio Setup options let you to set up the audio device and sound status settings depending on the audio system you are using.

1. With the unit in Stop mode, press the **MENU** button. Press the ◀▶ buttons to select **SETTINGS**, and then press the **ENTER** button.
2. Press the ▲/▼ buttons to select **AUDIO**, and then press the ▶ or **ENTER** button.
3. Press the ▲/▼ buttons to select the desired item, and then press the ▶ or **ENTER** button.

Each option in the Audio Setup Menu is described starting below.

### Dolby Digital Out

- **PCM**: Converts to PCM (2CH) audio.
- **Bitstream**: Outputs Dolby Digital via digital output.  
Select Bitstream when connecting to a Dolby Digital Decoder.

### MPEG2 Digital Output

- **PCM**: Converts to PCM (2CH) audio.
- **Bitstream**: Converts to MPEG-2 Digital Bitstream (5.1CH).  
Select Bitstream when using the Digital Audio Output.

### Dynamic Range Comp.

- **On**: To select dynamic range compression. This is useful for watching movies late at night, as it balances the loud and quiet portions of a disc.
- **Off**: To select the standard range.

### PCM Downsampling

- **On**: Select this when the amplifier connected to the player is not 96KHz compatible. In this case, the 96KHz signals will be down-converted to 48KHZ.
- **Off**: Select this when the amplifier connected to the player is 96KHz compatible. In this case, all signals will be output without any changes.

### Notes

- When playing a disc that has MPEG Audio and you have Bitstream selected in the Audio Options menu, the Digital Audio jack may not output audio.
- There is no output from the analog audio jacks when you play a DTS sound disc.
- Even when PCM Down sampling is Off, some discs will only output down sampled audio through the digital output.

Manufactured under license from Dolby Laboratories. "Dolby" and the double-D symbol are trademarks of Dolby Laboratories.

## Setting Up the Language Features

If you set the player menu, disc menu, audio, and subtitle language in advance, they will come up automatically every time you watch a movie.

### Using the Player Language Menu

1. With the unit in Stop mode, press the **MENU** button. Press the ◀▶ buttons to select **SETTINGS**, and then press the **ENTER** button.
2. Press the ▲/▼ buttons to select **LANGUAGE**, and then press the ▶ or **ENTER** button.
3. Press the ▲/▼ buttons to select the desired language, and then press the ▶ or **ENTER** button.

### Notes

- After you select the language, the screen returns to the Language Setup Page.
- To make the Setup menu disappear, press the MENU button.
- If the language you selected is not recorded on the disc, the player selects the original, pre-recorded language.
- Select "Original" if you want the default soundtrack language to be the original language the disc is recorded in.
- Select "Automatic" if you want the subtitle language to be the same as the language you selected for the audio language.
- Some discs may not contain the language you select. In that case, the disc will use its original language setting.

## Setting Up the Security Options

The Parental Control function works in conjunction with DVDs that have been assigned a rating, which helps you control the types of DVDs that your family watches. There are 8 rating (security) levels.

### Setting Up the Rating Level

1. With the unit in Stop mode, press the **MENU** button. Press the ◀▶ buttons to select **SETTINGS**, and then press the **ENTER** button.
2. Press the ▲/▼ buttons to select **SECURITY**, and then press the ▶ or **ENTER** button.
3. The first time you access security, you must enter the default password: 0000. To enter the default password, highlight 0 on the screen and press the **ENTER** button 4 times. To change the default password, see Change Password on page 12.
4. Press the ▲/▼ buttons to select **PARENTAL**, and then press the ▶ or **ENTER** button.
5. Press the ▲/▼ buttons to select the rating level you want, and then press the **ENTER** button. The higher the rating level, the more mature the allowable content.
  - If you select the Kid Safe level, discs rated level 2 or higher will not play unless you enter the password.

### Security Levels:

- ① **KID SAFE**
- ② **G** (General Audiences) : All Ages Admitted.
- ③ **PG** (Parental Guidance suggested) : Some material may not be suitable for young children.
- ④ **PG 13** (PG-13 Parents strongly cautioned) : Some material may be inappropriate for children under 13.
- ⑤ **PGR** (Parental Guidance Recommended) : These are not necessarily unsuitable for children, but viewer discretion is advised, and parents and guardians are encouraged to supervise younger viewers.
- ⑥ **R** (Restricted) : Under 17 requires accompanying adult
- ⑦ **NC17** (NC-17) : No one 17 and under admitted.
- ⑧ **ADULT**

#### Note:

- If you have forgotten your password, see "Forgot Password" in the Troubleshooting section.

### Changing the Password

To change the password, follow these steps:

1. On the Settings Menu, Select **Security**, and then press the **ENTER** button.
2. Enter the current 4 digit password. If you have never changed the password, enter the default password: 0000. To enter a number, use the ◀/▶/▲/▼ buttons to highlight a number, and then press the **ENTER** button.
3. Select **Change Password**, and then press the **ENTER** button.
4. Enter the new 4 digit password. Use the ◀/▶/▲/▼ buttons to select a number, and then press the **ENTER** button. Repeat 4 times.
5. Re-enter the new password in the same manner to confirm. The Security menu re-appears.

### Setting Up the General Options

1. With the unit in Stop mode, press the **MENU** button. Press the ◀/▶ buttons to select **SETTING**, and then press the **ENTER** button.
2. Press the ▲/▼ buttons to select **GENERAL**, and then press the ▶ or **ENTER** button.
3. Press the ▲/▼ buttons to select the desired item, and then press the ▶ or **ENTER** button.

Each option in the General Setup Menu is described starting below.

#### Screen Message

Use to turn on-screen messages On or Off.

#### Black Level

Adjusts the brightness of the screen (On or Off). This feature only functions in Video Composite mode. It does not have any effect in HDMI and Component modes.

#### Video Output

Select Video Output.

- **P-SCAN (Progressive)** : Select when you want to use Component Out.
- **I-SCAN (Interlaced)** : Select when you want to use Video or Component Out.

### Setting Up the Support Options

The Support option lets you check your DVD player information such as the model code and Software Version. The Serial Number can be found on the back side of your DVD-Player.

1. With the unit in Stop mode, press the **MENU** button. Press the ◀/▶ buttons to select **SETTINGS**, then press the **ENTER** button.
2. Press the ▲/▼ buttons to select **SUPPORT**, then press the ▶ or **ENTER** button.
3. Select **PRODUCT INFORMATION**, then press the ▶ or **ENTER** button.

## Reference

### Firmware upgrade

#### Introduction

Upgrading the Firmware will keep your DVD player up-to-date.

The latest firmware version for this unit is provided on the Samsung Website ([www.samsung.com](http://www.samsung.com)).

#### How to make an upgrade disc

You must burn the latest firmware version onto a blank CD-R or CD-RW disc:

1. Download a new file from Samsung's website ([www.samsung.com](http://www.samsung.com)) Download Center.
2. Write the file to disc using the data disc setting of your disc burning software.

#### Notes

The CD should be burned following the specs below:

- File System CD-ROM ISO Level.
- Character set ISO 9660.
- The burned CD has to be Finalized.
- Please make sure the filename is E360K.BIN
- Please make sure the root folder rename is MEDIATEK
- Please burn the CD at a low speed.

#### Upgrade procedure

1. Open the disc tray of your DVD Player. Place the burned disc on the tray. Close the tray. The Firmware upgrade screen will appear.
2. Press the **ENTER** or **PLAY** button to start the upgrade.
  - Press any other buttons on the remote control or eject the disc to cancel the upgrade.
  - During the firmware upgrade process, the tray will open. Please remove the disc and wait for about 2 minutes.
  - If the DVD player was successfully updated, the disc tray will close and the unit will turn off and on. When the unit turns on, the Select Menu Language screen will appear.
3. Press the ▲/▼ buttons to select the desired language, and then press the **ENTER** button.

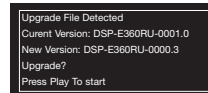

#### Firmware upgrade menu appears

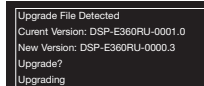
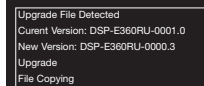

#### Firmware upgrade starts

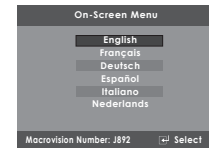

#### Notes

- If the "Select Menu Language" doesn't appear, please contact Samsung Customer Service.
- Do not press any button or unplug the power cord during the upgrade.
- The upgrade procedure may change. Refer to the web site ([www.samsung.com](http://www.samsung.com)).
- When software is upgraded, the video and audio settings you have made will return to their default (factory) settings. We recommend you write down your settings so that you can easily reset them after the upgrade.
- Samsung provides no assurance that all freeware disc burning software will be able to burn upgrade files that will work on the player.

#### Troubleshooting

Before requesting service, please check the following.

Problem	Action
The screen is blocked.	<ul style="list-style-type: none"><li>• Press the ►   button on the front panel for more than 5 seconds with no disc inside. All settings will revert to the factory settings.</li></ul>
Forgot password.	<ul style="list-style-type: none"><li>• Press the ►   button on the front panel for more than 5 seconds with no disc inside. All settings including the password will revert to the factory settings (0000). Don't use this unless absolutely necessary.</li></ul>

#### Specifications

General	Power Requirements	AC 120V ~ 60 Hz
	Power Consumption	10W (ON), 1W (OFF)
	Weight	2.4 lbs
	Dimensions	11.8" (W) X 8.19" (D) X 1.65" (H)
	Operating Temperature Range	+41°F to +95°F
	Operating Humidity Range	10 % to 75 %
Video Output	Composite Video	1 channel : 1.0 Vp-p (75 Ω load) 60Hz
	Component Video	Y : 1.0 Vp-p (75 Ω load) Pr : 0.70 Vp-p (75 Ω load) Pb : 0.70 Vp-p (75 Ω load) I-SCAN & P-SCAN 480i, 480p
Audio Output	Output terminal	2 CH
	Maximum Output Level	2Vrms
	Frequency Response	20Hz ~ 20kHz
	Digital Audio Output	Coaxial terminal (S/PDIF)

## LIMITED WARRANTY TO ORIGINAL PURCHASER

This SAMSUNG brand product, as supplied and distributed by SAMSUNG ELECTRONICS AMERICA, INC. (SAMSUNG) and delivered new, in the original carton to the original consumer purchaser, is warranted by SAMSUNG against manufacturing defects in materials and workmanship for the following limited warranty period:

**One (1) Year Parts / Ninety days (90) Labor**

This limited warranty begins on the original date of purchase, and is valid only on products purchased and used in the United States, and does not include transportation, installation, removal or reinstallation. Warranty repairs must be performed by SAMSUNG's authorized service center. To receive warranty service, the original dated bill of sale must be presented upon request as proof of purchase to SAMSUNG or SAMSUNG's authorized service center. Transportation to and from the service center is the responsibility of the purchaser.

SAMSUNG will repair or replace this product, at our option and at no charge with new or reconditioned parts, if found to be defective during the limited warranty period specified above. The product must be returned during the warranty period with transportation charges prepaid to SAMSUNG's designated service center. Prior to returning any product for warranty service, the purchaser must contact SAMSUNG for problem determination and service procedures. SAMSUNG does not warrant uninterrupted or error-free operation of the product. All replaced parts and products become the property of SAMSUNG and must be returned to SAMSUNG. Replacement parts and products assume the remaining original warranty, or ninety (90) days, whichever is longer.

This limited warranty covers manufacturing defects in materials and workmanship encountered in normal, non-commercial use of this product and shall not apply to the following, including, but not limited to: damage which occurs in shipment; applications and uses for which this product was not intended; failures or problems which are caused by products or equipment not supplied by SAMSUNG; accidents, misuse, abuse, neglect, misapplication, fire, water, light-ning or other acts of nature; incorrect electrical line voltage, fluctuations or surges; damage caused by improper or faulty installation; improper connection with any peripheral; product alteration or modification; improper or unauthorized repair; cosmetic damage or exterior finish; product with altered serial numbers; failure to follow operating instructions, customer adjustments, maintenance and environmental instructions that are covered and prescribed in the instruction book; use of non-SAMSUNG or unauthorized parts, supplies, accessories or equipment which damage this product or result in service problems; failures or problems due to incompatibility with other equipment.

## QUESTIONS OR COMMENTS?

COUNTRY	CALL	OR VISIT US ONLINE AT	WRITE
IN THE US	1-800-SAMSUNG (726-7864)	<a href="http://www.samsung.com">www.samsung.com</a>	Samsung Electronics America, Inc. 85 Challenger Road Ridgefield Park, NJ 07660-0511

## Contact SAMSUNG WORLD WIDE

If you have any questions or comments relating to Samsung products, please contact the SAMSUNG customer care center.

Region	Area	Contact Center ☎	Web Site
North America	Canada	1-800-SAMSUNG (726-7864)	www.samsung.com/ca
	Mexico	01-800-SAMSUNG (726-7864)	www.samsung.com/mx
	U.S.A	1-800-SAMSUNG (726-7864)	www.samsung.com/us
Latin America	Argentina	0800-333-3733	www.samsung.com/ar
	Brazil	0800-124-421, 4004-0000	www.samsung.com/br
	Chile	800-SAMSUNG (726-7864)	www.samsung.com/cl
	Nicaragua	00-1800-507267	www.samsung.com/latin
	Honduras	800-7919267	www.samsung.com/latin
	Costa Rica	0-800-507-7267	www.samsung.com/latin
	Ecuador	1-800-10-7267	www.samsung.com/latin
	El Salvador	800-6225	www.samsung.com/latin
	Guatemala	1-800-299-0013	www.samsung.com/latin
	Jamaica	1-800-234-7267	www.samsung.com/latin
	Panama	800-7267	www.samsung.com/latin
	Puerto Rico	1-800-682-3180	www.samsung.com/latin
	Rep. Dominicana	1-800-751-2676	www.samsung.com/latin
	Trinidad & Tobago	1-800-SAMSUNG (726-7864)	www.samsung.com/latin
Venezuela	0-800-100-5303	www.samsung.com/latin	
Europe	Colombia	01-8000112112	www.samsung.com.co
	Belgium	02 201 2418	www.samsung.com/be (Dutch) www.samsung.com/be_fr (French)
	Czech Republic	800-SAMSUNG (800-726786)	www.samsung.com/cz
	Denmark	8-SAMSUNG (7267864)	www.samsung.com/dk
	Finland	30-6227 515	www.samsung.com/fi
	France	01 4863 0000	www.samsung.com/fr
	Germany	01805-SAMSUNG (726-7864 € 0.14/Min)	www.samsung.de
	Hungary	06-80-SAMSUNG (726-7864)	www.samsung.com/hu
	Italy	800-SAMSUNG (726-7864)	www.samsung.com/it
	Luxemburg	02 261 03 710	www.samsung.com/lu
	Netherlands	0900-SAMSUNG (0900-7267864) (€ 0.10/Min)	www.samsung.com/nl
	Norway	3-SAMSUNG (7267864)	www.samsung.com/no
	Poland	0 801 1SAMSUNG (172678), 022-607-93-33	www.samsung.com/pl
	Portugal	80820-SAMSUNG (726-7864)	www.samsung.com/pt
	Slovakia	0800-SAMSUNG (726-7864)	www.samsung.com/sk
	Spain	902-1-SAMSUNG (902 172 678)	www.samsung.com/es
	Sweden	0771 726 7864 (SAMSUNG)	www.samsung.com/se
	U.K	0845 SAMSUNG (7267864)	www.samsung.com/uk
	Ireland	0818 717 100	www.samsung.com/ie
Austria	0810-SAMSUNG (7267864, € 0.07/min)	www.samsung.com/at	
Switzerland	0848-SAMSUNG (7267864, CHF 0.08/min)	www.samsung.com/ch www.samsung.com/ch_fr (French)	
CIS	Russia	8-800-555-55-55	www.samsung.ru
	Kazakhstan	8-10-800-500-55-500	www.samsung.com/kz_ru
	Uzbekistan	8-10-800-500-55-500	www.samsung.com/uz_ru
	Kyrgyzstan	00-800-500-55-500	
	Tadjikistan	8-10-800-500-55-500	
	Ukraine	8-800-502-0000	www.samsung.ua www.samsung.com/ua_ru
	Belarus	810-800-500-55-500	
	Moldova	00-800-500-55-500	
Asia Pacific	Lithuania	8-800-77777	www.samsung.com/lt
	Latvia	8000-7267	www.samsung.com/lv
	Estonia	800-7267	www.samsung.com/ee
	Australia	1300 362 603	www.samsung.com/au
	New Zealand	0800 SAMSUNG (0800 726 786)	www.samsung.com/nz
	China	400-810-5858, 010-6475 1880	www.samsung.com/cn
	Hong Kong	3698-4698	www.samsung.com/hk
	India	3030 8282, 1800 110011, 1800 3000 8282	www.samsung.com/hk_en/ www.samsung.com/in
	Indonesia	0800-112-8888	www.samsung.com/id
	Japan	0120-327-527	www.samsung.com/jp
	Malaysia	1800-88-9999	www.samsung.com/my
	Philippines	1-800-10-SAMSUNG (726-7864), 1-800-3-SAMSUNG (726-7864), 1-800-8-SAMSUNG (726-7864), 02-5805777	www.samsung.com/ph
	Singapore	1800-SAMSUNG (726-7864)	www.samsung.com/sg
	Thailand	1800-29-3232, 02-689-3232	www.samsung.com/th
Taiwan	0800-329-999	www.samsung.com/tw	
Middle East & Africa	Vietnam	1 800 688 869	www.samsung.com/vn
	Turkey	444 77 11	www.samsung.com/tr
	South Africa	0860-SAMSUNG (726-7864)	www.samsung.com/za
	U.A.E	800-SAMSUNG (726-7864), 8000-4726	www.samsung.com/ae



AK68-02218A-00