

# SIGNATURE SERIES SOTTILE WINE RESERVE

**HH24WS-3** | 24" INDOOR MODEL  
**HH24WO-3** | 24" OUTDOOR MODEL

**Perlick**<sup>®</sup>  
QUALITY & INNOVATION  
THAT **INSPIRES**



*Solid Door Model*



*Glass Door Model*



## GENERAL SIGNATURE SERIES SOTTILE FEATURES

- 32" height including leveling legs
- **Industry Exclusive** 18" depth for design flexibility
- Plug recessed for true 18" depth
- Zero-clearance hinging allows for abutment with surrounding cabinetry
- 525 Btu commercial-grade compressor
- Front-vented, RAPIDcool forced-air refrigeration system
- Commercial-grade stainless steel interior and exterior
- **Industry Exclusive** convertible door design allows all doors the ability to be converted to wood overlay from stainless steel
- **Industry Exclusive** adjustable, full-extension pull-out shelves
- Stainless-steel ball-bearing glides provide smooth movement of shelves
- Low E, UV-coated glass provides industry leading insulation and protection.
- Digital temperature controller
- Adjustable Crisp White and Cool Blue LED lighting
- Optional door locks (factory installed)
- Stacking kit available
- Also available - Refrigerator and Beverage Center
- 3.1 cubic feet of capacity
- Industry Best Three Year Warranty plus additional three years on sealed system

## HH24WS FEATURES

- Available with solid stainless steel door, solid wood overlay door, stainless steel glass door or wood overlay glass doors
- Includes four (4) full-extension wine shelves
- Wine shelves feature stainless steel fronts
- Product capacity is 20 wine bottles (750 ml.)
- Refrigerator temperature 45°- 65°F

Form No.HH24WS-3  
Rev. 1.8.2015

## PRODUCT SPECIFICATIONS

<b>Overall Width</b>	23-7/8" (60.64 cm.)
<b>Overall Height</b>	32" (81.28 cm.)
<b>Overall Depth</b>	18" (45.72 cm.)
<b>Opening Width</b>	24" (60.96 cm.)
<b>Opening Height</b>	32-1/8" (81.60 cm.)
<b>Opening Depth</b>	18" (45.72 cm.)
<b>Refrigerated Volume</b>	3.1 cu. ft.
<b>Door Swing Clearance</b>	25" (63.5 cm.) minimum
<b>Electrical</b>	115V, 60Hz, 1 Phase, 2.3 amps
<b>Plumbing</b>	None Required
<b>Shipping Weight</b>	185 lbs (83.91 kg.)

## INDOOR MODELS

<b>HH24WS-3-1L*</b>	Solid stainless steel door, hinge left
<b>HH24WS-3-2L*</b>	Solid wood overlay door, hinge left
<b>HH24WS-3-3L*</b>	Stainless steel glass door, hinge left
<b>HH24WS-3-4L*</b>	Wood overlay glass door, hinge left

## OUTDOOR MODELS

<b>HH24WO-3-1L*</b>	Solid stainless steel door, hinge left
<b>HH24WO-3-2L*</b>	Solid wood overlay door, hinge left
<b>HH24WO-3-3L*</b>	Stainless steel glass door, hinge left
<b>HH24WO-3-4L*</b>	Wood overlay glass door, hinge left

\* Also available hinge right

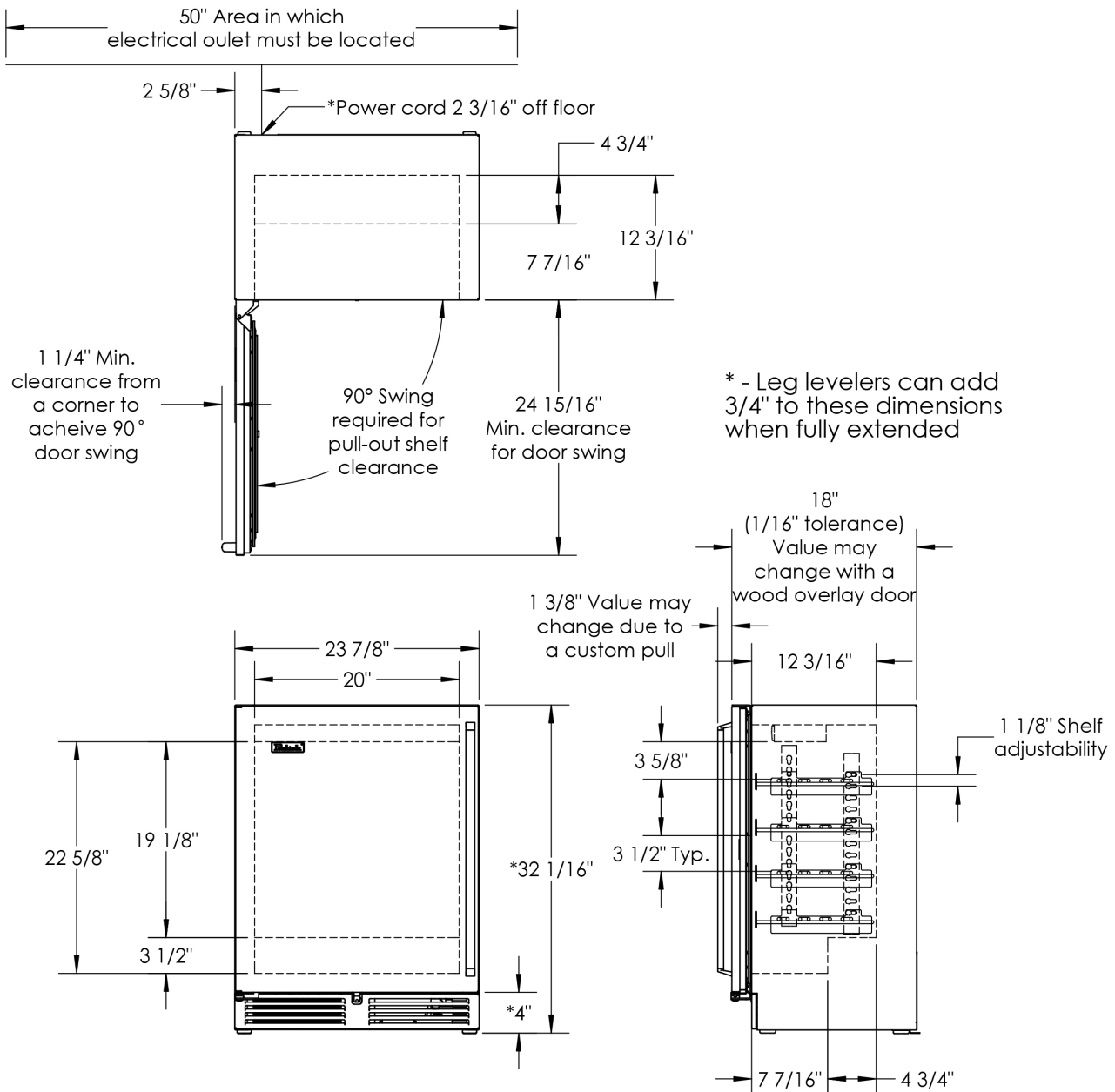

Form No. HH24WS-3  
Rev. 1.08.2015