



OWNER'S MANUAL

MICROWAVE OVEN

PLEASE READ THIS OWNER'S MANUAL THOROUGHLY
BEFORE OPERATING.

LMV1683SW
LMV1683SB
LMV1683ST

Thank you for purchasing a LG microwave oven.

Please record the model number and serial number of this unit for future reference. We also suggest you record the details of your contact with LG (LG Electronics U.S.A., Inc.) concerning this unit.

Model No: _____

Serial No: _____

Dealer: _____

Dealer Phone No: _____

Staple your receipt here as proof of purchase.

Customer Relations
LG Electronics U.S.A., Inc.
Service Division Bldg. #3
201 James Record Rd.
Huntsville, AL 35824-0126

PRECAUTIONS TO AVOID POSSIBLE EXPOSURE TO EXCESSIVE MICROWAVE ENERGY...

- (a) Do not attempt to operate this oven with the door open since open-door operation can result in harmful exposure to microwave energy. It is important not to defeat or tamper with the safety interlocks.
- (b) Do not place any object between the oven front face and the door or allow soil or cleaner residue to accumulate on sealing surfaces.
- (c) Do not operate the oven if it is damaged. It is particularly important that the oven door closes properly and that there is no damage to the:
 - (1) Door (bent),
 - (2) Hinges and latches (broken or loosened),
 - (3) Door seals and sealing surfaces.
- (d) The oven should not be adjusted or repaired by anyone except properly qualified service personnel.

TABLE OF CONTENTS

PRECAUTIONS TO AVOID POSSIBLE EXPOSURE TO EXCESSIVE MICROWAVE ENERGY	2	Defrosting Tips.....	16
TABLE OF CONTENTS	3	Using Quick Touch.....	17
SAFETY	4	Popcorn.....	17
Important Safety Instructions.....	4~5	Pizza.....	17
INFORMATION	6	Frozen Entree.....	17
Location of Model Number.....	6	Potato.....	17
Oven Specifications.....	6	Auto Cook.....	18
Electrical Rating.....	6	Cooking Guide for Auto Cook.....	18
Electrical Requirements.....	6	Auto Reheat.....	19
Grounding Instructions.....	6	Cooking Guide for Auto Reheat.....	19
Microwave Oven Features.....	7	COOKING	20
Oven Control Panel.....	8~9	GETTING THE BEST COOKING RESULTS	20
OPERATION	10	FISH & SHELLFISH	20
LEARN ABOUT YOUR MICROWAVE OVEN	10	Cooking Fish and Shellfish: General Directions.....	20
Audible Signals.....	10	Fish And Shellfish Cooking Table.....	20
Clock.....	10	APPETIZERS / SAUCES / SOUPS	21
Interrupting Cooking.....	10	Cooking Appetizers: Tips and Techniques.....	21
Child Lock.....	10	MEAT	21
VENT Hi/Low/Off.....	11	Cooking Meat: General Directions.....	21
Cooktop Light.....	11	Meat Cooking Table.....	22
ADD 30 SEC.....	11	POULTRY	23
Time Defrost.....	11	Cooking Poultry: General Directions.....	23
Timed Cooking.....	12	Poultry Cooking Table.....	23
Multi-stage Cooking.....	12	PASTA AND RICE	24
MELT.....	13	Cooking Pasta and Rice: Tips and Techniques.....	24
SOFTEN.....	13	Pasta Cooking Table.....	24
MELT TABLE.....	13	Rice Cooking Table.....	24
SOFTEN TABLE.....	13	MAINTENANCE	25
ENERGY SAVING.....	13	CARE AND CLEANING	25
Microwave Power Levels.....	14	Cleaning the Grease Filters.....	25
Auto Defrost.....	15	Charcoal Filter Replacement.....	25
Operating Tips.....	15	Cooktop/Night Light Replacement.....	26
		Oven Light Replacement.....	26
		QUESTIONS AND ANSWERS	26
		MICROWAVE UTENSIL GUIDE	27
		BEFORE CALLING FOR SERVICE	28
		WARRANTY	29

SAFETY

IMPORTANT SAFETY INSTRUCTIONS

The safety instructions below will tell you how to use your oven and avoid harm to yourself or damage to your oven.

⚠ WARNING - To reduce the risk of burns, electric shock, fire, injury to persons, or exposure to excessive microwave energy.

• **Read all the instructions before using your oven.**

• **Do not allow children to use this oven without close supervision.**

• Read and follow the specific

PRECAUTIONS TO AVOID POSSIBLE EXPOSURE TO EXCESSIVE MICROWAVE ENERGY

found on page 2.

• **Do not use** corrosive chemicals or vapors, such as sulfide and chloride, in this appliance. This type of oven is specifically designed to heat, cook, or dry food. It is not designed for industrial or laboratory use.

• **Do not store** this appliance outdoors. Do not use this product near water - for example, near a kitchen sink, in a wet basement, near a swimming pool, or similar location.

• **Do not use** the cavity for storage purposes. Do not leave paper products, cooking utensils, or food in the cavity when not in use.

• **Clean the ventilating hood frequently.** Do not allow grease to accumulate on the hood or the filters.

• Use care when cleaning the vent hood filters. Corrosive cleaning agents such as lye-based oven cleaners may damage the filters.

• **Do not tamper with the built-in safety switches on the oven door.** The oven has several built-in safety switches to make sure the power is off when the door is open.

• **Turn the fan on in case of steam or smoke under the hood.** Keep area under the hood properly ventilated at all times. Turn off cooking equipment in case of fire, or if flames or flare-up occurs.

• Suitable for use above both gas and electric cooking equipment 36 inches wide or less.

• **Do not use this oven for commercial purposes.** It is made for household use only.

• **When cleaning the door and the surfaces that touch the door, use only mild, non-abrasive soaps or detergents and a sponge or soft cloth.**

• **If your oven is dropped or damaged,** have it thoroughly checked by a qualified service technician before using it again.

• **To avoid a fire hazard:**

- **Do not severely overcook food.** Severely overcooked foods can start a fire in the oven. Watch the oven carefully, especially if you have paper, plastic, or other combustibles in the oven.

- **Do not store combustible items (bread, cookies, etc.) in the oven,** because if lightning strikes the power lines it may cause the oven to turn on.

- **Do not use wire twist-ties in the oven.** Be sure to inspect purchased items for wire twist-ties and remove them before placing the item in the oven.

• **If a fire should start:**

- **Keep the oven door closed.**

- **Turn the oven off.**

- **Disconnect the power cord or shut off the power at the fuse or circuit breaker panel.**

• **To avoid electric shock:**

- **This appliance must be grounded.** Connect it only to a properly grounded outlet. See the electrical **GROUNDING INSTRUCTIONS** on page 6.

- **Do not operate this appliance if it has a damaged cord or plug,** if it is not working properly or if it has been damaged or dropped.

- **Do not immerse the electrical cord or plug in water.**

- **Keep the cord away from heated surfaces.**

SAFETY

- **To avoid improperly cooking some foods.**
 - **Do not heat any types of baby bottles or baby food.** Uneven heating may occur and possibly cause personal injury.
 - **Do not heat small-necked containers,** such as syrup bottles.
 - **Do not deep-fat fry in your microwave oven.**
 - **Do not attempt home canning in your microwave oven.**
 - **Do not heat the following items in the microwave oven:** whole eggs in the shell, water with oil or fat, sealed containers, or closed glass jars. These items may explode.
- Do not cover or block any openings in the oven.
- Use your oven only for the operations described in this manual.
- Do not run the oven empty, without food in it.
- Do not let cord hang over edge of table or counter.
- **Preserve the oven floor:**
 - **Do not heat the oven floor excessively.**
 - **Do not** allow the gray film on special microwave-cooking packages to touch the oven floor. Put the package on a microwavable dish.
 - **Do not** cook anything directly on the oven floor or turntable. Use a microwavable dish.
 - Keep a browning dish at least 3/16 inch above floor. Carefully read and follow the instructions for the browning dish. If you use a browning dish incorrectly, you could damage the oven floor.
- Install or locate this appliance only in accordance with the provided installation instructions.
- This appliance should be serviced only by qualified service personnel. Contact the nearest authorized service facility for examination, repair, or adjustment.
- Liquids, such as water, coffee, or tea are able to be overheated beyond the boiling point without appearing to be boiling. Visible bubbling or boiling when the container is removed from the microwave oven is not always present.

THIS COULD RESULT IN VERY HOT LIQUIDS SUDDENLY BOILING OVER WHEN THE CONTAINER IS DISTURBED OR A SPOON OR OTHER UTENSIL IS INSERTED INTO THE LIQUID. To reduce the risk of injury to persons;

 - Do not overheat the liquid.
 - Stir the liquid both before and halfway through heating it.
 - Do not use straight-sided containers with narrow necks.
 - After heating, allow the container to stand in the microwave oven for a short time before removing the container.
 - Use extreme care when inserting a spoon or other utensil into the container.

SAVE THESE INSTRUCTIONS

FEDERAL COMMUNICATIONS COMMISSION RADIO FREQUENCY INTERFERENCE STATEMENT (U.S.A. ONLY)

WARNING:

This equipment generates and uses ISM frequency energy and if not installed and used properly, that is in strict accordance with the manufacturer's instructions, may cause interference to radio and television reception. It has been type tested and found to comply with limits for ISM Equipment pursuant to part 18 of FCC Rules, which are designed to provide reasonable protection against such interference in a residential installation. However, there is no guarantee that interference will not occur in a particular installation. If this equipment does cause interference to radio or television reception, which can be determined by turning the equipment off and on, the user is encouraged to try to correct the interference by one or more of the following:

- Reorient the receiving antenna of the radio or television.
- Relocate the Microwave Oven with respect to the receiver.
- Move the microwave oven away from the receiver.
- Plug the microwave oven into a different outlet so that the microwave oven and the receiver are on different branch circuits.

The manufacturer is not responsible for any radio or TV interference caused by **unauthorized modification** to this microwave oven. It is the responsibility of the user to correct such interference.

INFORMATION

Please read this owner's manual. It will tell you how to use all the fine features of this microwave oven.

LOCATION OF MODEL NUMBER

To request service information or replacement parts, the service center will require the complete model number of your microwave oven. The number is on the left side of control panel as shown in the illustration below.

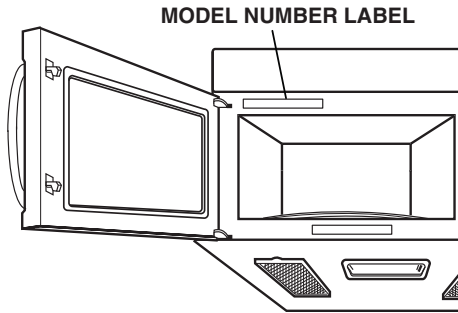

OVEN SPECIFICATIONS

Output Power 1,000W (IEC 60705 Standard)
Outer Dimensions 29-15/16" x 16-7/16" x 16-15/16"
Cavity Volume 1.6 Cu.ft
Net Weight 52 lbs.

ELECTRICAL RATING

* Electrical Rating of the Oven: 120V AC 60Hz
* 14 Amps / 1500 Watts (MWO + Cooktop Lamp + Ventilation Fan)

ELECTRICAL REQUIREMENTS

The oven is designed to operate on a Standard 120V/60Hz household outlet. Be sure the circuit is at least 15A or 20A and the microwave oven is the **only appliance on the circuit**. It is not designed for 50Hz or any circuit other than a 120V/60Hz circuit.

GROUNDING INSTRUCTIONS

This appliance must be grounded. If an electrical short circuit occurs, grounding reduces the risk of electric shock by providing an escape wire for the electric current. The cord for this appliance has a grounding wire with a grounding plug. Put the plug into an outlet that is properly installed and grounded.

⚠ WARNING - If you use the grounding plug improperly, you risk electric shock.

Ask a qualified electrician if you do not understand the grounding instructions or if you wonder whether the appliance is properly grounded.

Because this appliance fits under the cabinet, it has a short power-supply cord. See the separate Installation Instructions for directions on properly placing the cord. Keep the electrical power cord dry and do not pinch or crush it in any way.

If it is necessary to use an extension cord, use only a 3-wire extension cord that has a 3-blade grounding plug, and a 3-slot receptacle that will accept the plug on the appliance. The marked rating of the extension cord shall be equal to or greater than the electrical rating of the appliance.

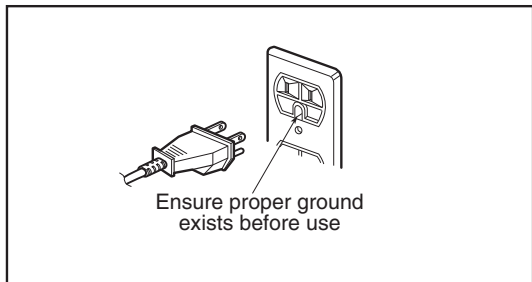

For a permanently connected appliance:

This appliance must be connected to a grounded, metallic, permanent wiring system, or an equipment grounding conductor should be run with the circuit conductors and connected to the equipment grounding terminal or lead on the appliance.

INFORMATION

MICROWAVE OVEN FEATURES

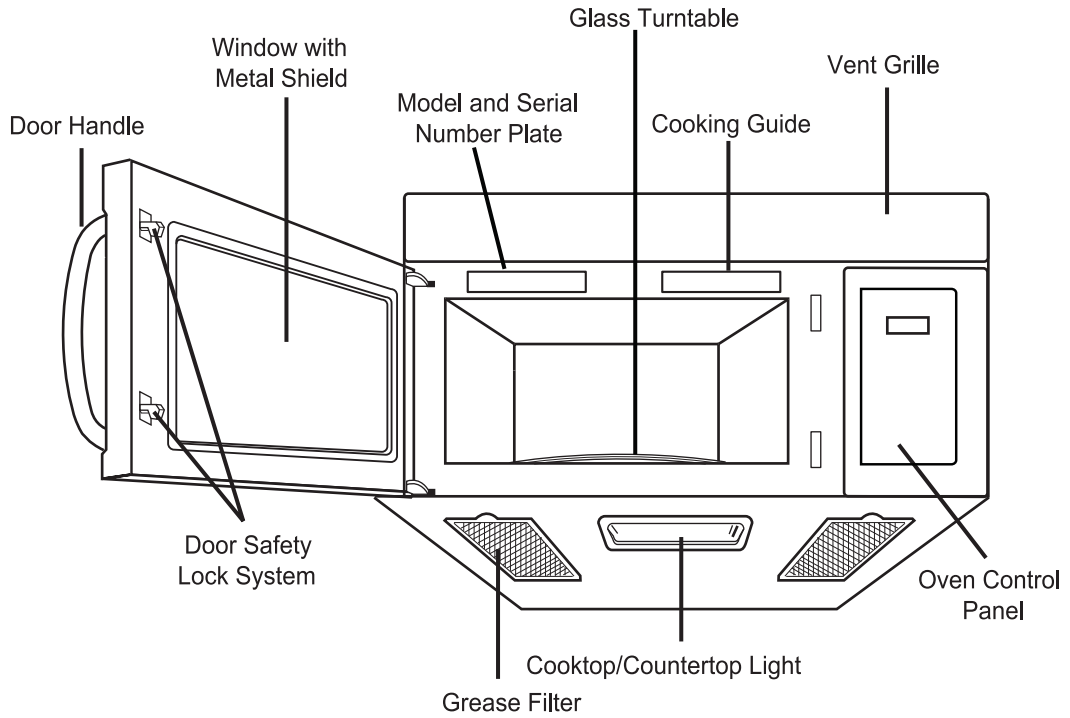

INFORMATION

OVEN CONTROL PANEL

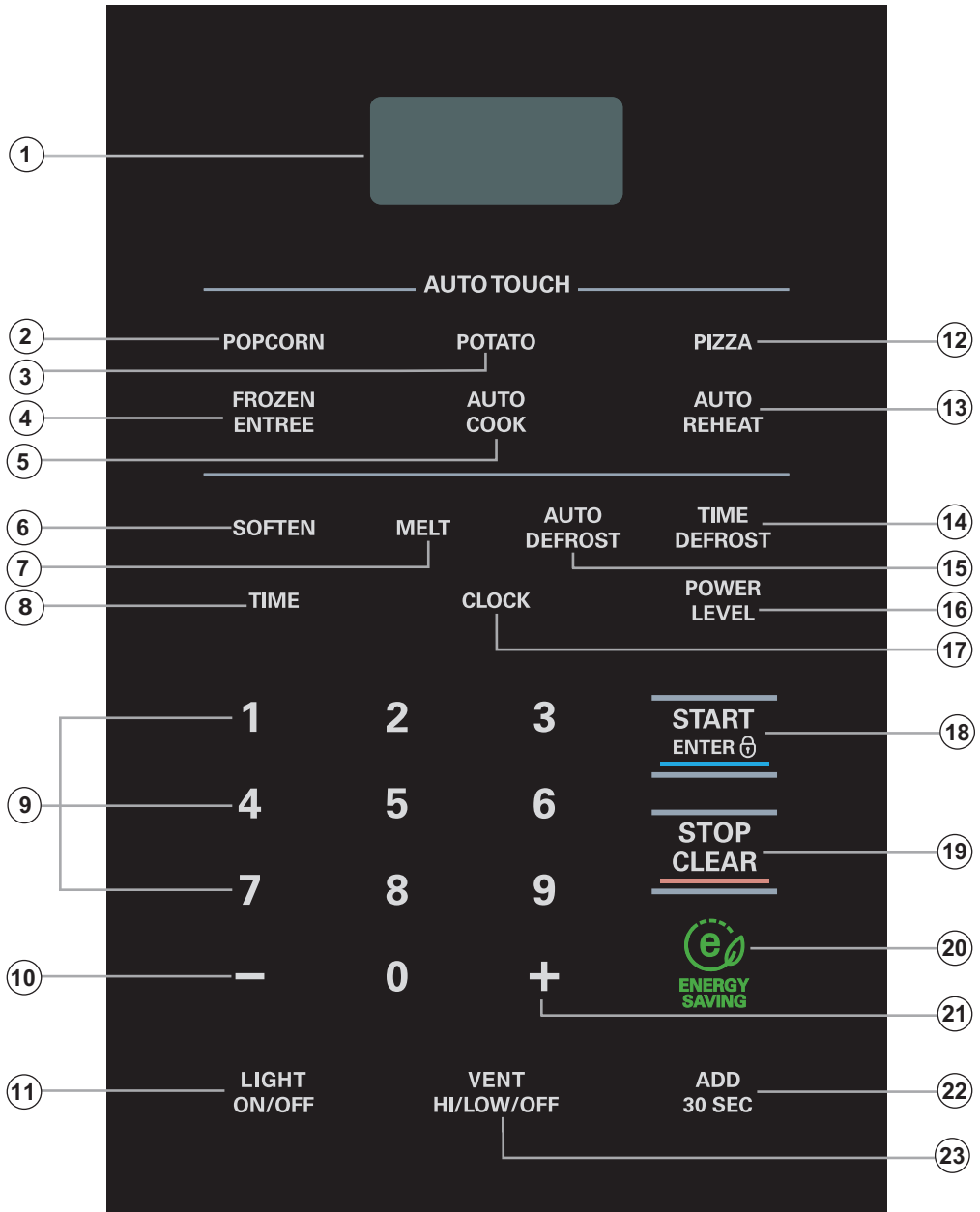

INFORMATION

- 1. DISPLAY:** The Display includes a clock and indicators to tell you time of day, cooking time settings and cooking functions selected.
 - 2. POPCORN:** Touch this pad when popping popcorn in your microwave oven.
 - 3. POTATO.** Touch this pad to cook up to 4 potatoes without entering a cook time or power.
 - 4. FROZEN ENTREE.** Touch this pad to cook a 10 to 20 ounce (284 to 567 g) frozen entree without entering a cook time or power.
 - 5. AUTO COOK.** Touch this pad to cook microwavable foods without entering a cook time or power.
 - 6. SOFTEN.** Touch this pad to soften butter, ice cream, cream cheese, frozen juice.
 - 7. MELT.** Touch this pad to melt butter or margarine, chocolate, cheese, marshmallow.
 - 8. TIME.** Touch this pad followed by number pads to set a cooking time.
 - 9. NUMBER.** Touch number pads to enter cooking time, power level, quantities or weights.
 - 10. LESS.** Touch this pad to subtract ten seconds of cooking time each time you press it.
 - 11 LIGHT ON/OFF.** Touch this pad to turn the cooktop/countertop light on or off.
 - 12. PIZZA.** Touch this pad to reheat one or several slices of pizza without entering a cook time or power.
 - 13. AUTO REHEAT.** Touch this pad to reheat microwavable foods without entering a cook time or power.
 - 14. TIME DEFROST.** Touch this pad to set a defrost time.
 - 15. AUTO DEFROST.** Touch this pad followed by number pads to thaw frozen meat by weight.
 - 16. POWER LEVEL.** Touch this pad to select a cooking power level.
 - 17. CLOCK.** Touch this pad to enter the time of day.
 - 18. START/ENTER:** Touch this pad to start a function. If you open the door after oven begins to cook, retouch START/ENTER.
 - 19. STOP/CLEAR:** Touch this pad to stop the oven or clear all entries.
 - 20. ENERGY SAVING:** Touch this pad to save energy.
 - 21. MORE.** Touch this pad to add ten seconds of cooking time each time you press it.
 - 22. ADD 30 SEC.** Touch this pad to add 30 seconds of cooking time each time you press it.
 - 23. VENT HI/LOW/OFF.** Touch this pad to turn the Vent on or off.
- NOTE: If you try to enter** incorrect instructions, you will not hear any tones. Touch STOP/CLEAR and re-enter the instructions.

OPERATION

LEARN ABOUT YOUR MICROWAVE OVEN

This section discusses the concepts behind microwave cooking and introduces you to the basics you need to know to operate your microwave oven. Please read this information before use.

AUDIBLE SIGNALS

Audible signals are available to guide you when setting and using your oven:

- **A programming tone will sound** each time you touch a pad.
- **Four tones** signal the end of a cooking cycle.

INTERRUPTING COOKING

You can stop the oven during a cycle by opening the door. The oven stops heating and the fan stops, but the light stays on.

To restart cooking, close the door and Touch START.

If you do not want to continue cooking, open the door and touch STOP/CLEAR.

CLOCK

When your microwave oven is first plugged in or after a power failure, the Display will show “:.”. If a time of day is not set, “:.” will show on the Display until you touch “Clock”.

Example: To set the clock for 10:30(AM or PM).

Touch:	Display Shows:
1. <u>STOP CLEAR</u>	:.
2. <u>CLOCK</u>	12:00
3. 1 0 3 0	10:30
4. <u>START ENTER</u> 	10:30

NOTES:

- **If you enter** in an incorrect time and touch “Clock”, you cannot set time of day. Enter the correct time.
- **If you touch STOP CLEAR** while setting the clock, the Display will show the last time of day set or “:.” if no time of day has been set.

CHILD LOCK

Use this safety feature to lock the control panel when you are cleaning the oven, or so that children cannot use the oven unsupervised.

To set CHILD LOCK:

Touch:	Display Shows:
1. <u>STOP CLEAR</u>	:.
2. <u>START ENTER</u> 	Touch and hold until “L” appears in the display. (approximately 4 seconds)

To cancel CHILD LOCK:

Touch:	Display Shows:
1. <u>START ENTER</u> 	Touch and hold until “L” disappears in the display. (approximately 4 seconds)

OPERATION

TIMED COOKING

This feature lets you program a specific cook time and power. For best results, there are 10 power level settings in addition to HIGH (100%) power. Refer to the "Microwave Power Levels Table" on page 14 for more information.

NOTE: If you do not select a power level, the oven will automatically cook at HIGH (100%) power.

Example: To cook for 5 minutes, 30 seconds at 80% power.

Touch:	Display Shows:
1. TIME	: 0
2. 5 3 0	5 : 30
3. POWER LEVEL	P-HI
4. 8	P-80
5. START ENTER 	Time counting down and COOK .

MULTI-STAGE COOKING

For best results, some recipes call for different cook powers during different stages of a cook cycle. You can program your oven to switch from one power level to another for up to 2 stages.

Example: To set a 2-stage cook cycle.

Touch: **Display Shows:**

1. **TIME** : 0

2. 3 0 0 3 : 00

To set a 3 minute cook time for first stage.

3. **POWER LEVEL** P-HI

4. 8 P-80

To set an 80% cook power for the first stage.

5. **TIME** : 0

6. 7 0 0 7 : 00

To set a 7 minute cook time for second stage.

7. **POWER LEVEL** P-HI

8. 5 P-50

To set a 50% cook power for the second stage.

9. **START ENTER**  Time counting down and **COOK**.

10. When the first stage is over, you will hear two short tones as the oven begins the second cook stage.

OPERATION

MELT

Melt provides four preset categories for melt. Butter, Chocolate, Cheese, Marshmallows. Details refer to **MELT TABLE**.

Example: To Melt 16 oz Cheese.

STOP CLEAR

1. Touch **STOP/CLEAR**.

MELT

2. Touch **MELT** pad three times.

2

3. Choose 16 oz.

START ENTER

4. Touch **START/ENTER**.

NOTE: After 4 seconds, the oven will start automatically. When the cook time is over, you will hear four beeps and **End** will display.

SOFTEN

Soften provides four preset categories for melt. Butter, Ice Cream, Cream Cheese, Frozen Juice. Details refer to **SOFTEN TABLE**.

STOP CLEAR

1. Touch **STOP/CLEAR**.

SOFTEN

2. Touch **SOFTEN** pad three times.

1

3. Choose 3 oz.

START ENTER

4. Touch **START/ENTER**.

NOTE: After 4 seconds, the oven will start automatically. When the cook time is over, you will hear four beeps and **End** will display.

MELT TABLE

Category	Touch pad times	Touch pad number		
		1	2	3
Butter	1	1 stick	2 sticks	3 sticks
Chocolate	2	4 oz	8 oz	–
Cheese	3	8 oz	16 oz	–
Marshmallows	4	5 oz	10 oz	–

SOFTEN TABLE

Category	Touch pad times	Touch pad number		
		1	2	3
Butter	1	1 stick	2 sticks	3 sticks
Ice Cream	2	pint	quart	half gallon
Cream Cheese	3	3 oz	8 oz	–
Frozen Juice	4	6 oz	12 oz	16 oz

ENERGY SAVING

ENERGY SAVING feature saves energy by turning off the display.

The display will also turn off when the unit is not active for 5 minutes.

1. **STOP CLEAR** :

2. **ENERGY SAVING**

3. **ENERGY SAVING** :

OPERATION

MICROWAVE POWER LEVELS

For best results, some recipes call for different cook powers. The lower the cook power, the slower the cooking. Each number from 1 to 9 stands for a different percentage of full cook power.

The following chart gives the percentage of cook power each number pad stands for, and the cook power name usually used.

It also tells you when to use each cook power. Follow recipe or food package instructions if available.

NOTE: Refer to a reliable cookbook for cooking times based on the 1000 Watt cook power of your microwave oven.

COOK Power	NAME	WHEN TO USE IT
100% of full power	High	<ul style="list-style-type: none">• Quick heating many convenience foods and foods with high water content, such as soups and beverages.• Cooking tender cuts of meat, ground meat,
9 = 90% of full power		<ul style="list-style-type: none">• Heating cream soups
8 = 80% of full power		<ul style="list-style-type: none">• Heating rice, pasta, or casseroles
7 = 70% of full power	Medium-High	<ul style="list-style-type: none">• Cooking and heating foods that need a Cook Power lower than high (for example, whole fish and meat loaf) or when food is cooking too fast• Reheating a single serving of food
6 = 60% of full power		<ul style="list-style-type: none">• Cooking requiring special care, such as cheese and egg dishes, pudding, and custards• Finishing cooking casseroles
5 = 50% of full power	Medium	<ul style="list-style-type: none">• Cooking ham, whole poultry, and pot roasts• Simmering stews
4 = 40% of full power		<ul style="list-style-type: none">• Melting chocolate• Heating pastries
3 = 30% of full power	Medium-Low, Defrost	<ul style="list-style-type: none">• Manually defrosting foods, such as bread, fish, meats, poultry, and precooked foods
2 = 20% of full power		<ul style="list-style-type: none">• Softening butter, cheese, and ice cream
1 = 10% of full power	Low	<ul style="list-style-type: none">• Keeping food warm• Taking chill out of fruit

NOTE: Once cook time has been entered, you can also use the POWER LEVEL pad as a second Kitchen Timer by entering "0" for the Cook Power. The oven will count down the cooking time you set without cooking.

OPERATION

AUTO DEFROST

Four defrost sequences are preset in the oven. The auto defrost feature provides you with the best defrosting method for frozen foods. The cooking guide will show you which defrost sequence is recommended for the food you are defrosting.

For added convenience, the Auto Defrost includes a built-in beep mechanism that reminds you to check, turn over, separate, or rearrange to get best defrost results. Four different defrosting levels are provided.

- 1 MEAT
- 2 POULTRY
- 3 FISH
- 4 BREAD

*First three available weight is 0.1~6.0 lbs.
The last available weight is 0.1~1.0 lbs.

Example: To defrost 1.2 lbs of ground beef.	
Touch:	Display Shows:
1. AUTO DEFROST	<i>def1</i>
2. 1 2	<i>1.2</i>
To enter the weight	
3. START ENTER	Time counting down.

NOTE:

When you touch the START ENTER pad, the display changes to defrost time count down. The oven will beep during the DEFROST cycle. At this time, open the door and turn, separate, or rearrange the food. Remove any portions that have thawed. Return frozen portions to the oven and touch START ENTER to resume the defrost cycle.

OPERATING TIPS

- For best results, remove fish, shellfish, meat, and poultry from its original closed paper or plastic package (wrapper). Otherwise, the wrap will hold steam and juice close to the foods, which can cause the outer surface of the foods to cook.
- For best results, shape your ground meat into the form of a doughnut before freezing. When defrosting, scrape off thawed meat when the beep sounds and continue defrosting.
- Place foods in a shallow container.

This table shows you food type selections and the weights you can set for each type. For best results, loosen or remove covering on food.

FOOD	TOUCH Auto Defrost	WEIGHTS YOU CAN SET (tenths of a pound)
Meat	1 Time(s)	.1 to 6.0 (45g to 2722g)
Poultry	2 Time(s)	.1 to 6.0 (45g to 2722g)
Fish	3 Time(s)	.1 to 6.0 (45g to 2722g)
BREAD	4 Time(s)	.1 to 1.0 (45g to 450g)

Category	Food
MEAT 0.1 to 6.0 lbs	BEEF Ground beef, Round steak, Cubes for stew, Tenderloin steak, Pot roast, Rib roast, Rump roast, Chuck roast, Hamburger patty. LAMB Chops (1-inch thick), Rolled roast. PORK Chops (1/2-inch thick), Hot dogs, Spareribs, Countrystyle ribs. Rolled roast, Sausage.
POULTRY 0.1 to 6.0 lbs	POULTRY Whole (under 4 lbs), Cut up, Breasts (boneless). CORNISH HENS Whole. TURKEY Breast (under 6 lbs).
FISH 0.1 to 6.0 lbs	FISH Fillets, Whole Steaks. SHELLFISH Crab meat, Lobster tails, Shrimp, Scallops.
BREAD 0.1 to 1.0 lbs	Sliced bread, Buns, Baguette, etc. Separate slices and place between paper towel or flat plate. Turn food over at beep After defrosting, let stand for 1-2 minutes

OPERATION

DEFROSTING TIPS

- **When using** Auto Defrost, the weight to be entered is the net weight in pounds and tenths of pounds (the weight of the food minus the container).
- **Before starting**, make sure you have removed any of the metal twist-ties which often come with frozen food bags, and replace them with strings or elastic bands.
- **Open containers** such as cartons before they are placed in the oven.
- **Always slit** or pierce plastic pouches or packaging.
- **If food is foil wrapped**, remove foil and place it in a suitable container.
- **Slit** the skins, if any, of frozen food such as sausage.
- **Bend** plastic pouches of food to ensure even defrosting.
- **Always underestimate** defrosting time. If defrosted food is still icy in the center, return it to the microwave oven for more defrosting.
- **The length** of defrosting time varies according to how solidly the food is frozen.
- **The shape of the package** affects how quickly food will defrost. Shallow packages will defrost more quickly than a deep block.
- **As food begins to defrost**, separate the pieces. Separated pieces defrost more easily.
- **Use small pieces of aluminum foil** to shield parts of food such as chicken wings, leg tips, fish tails, or areas that start to get warm. Make sure the foil does not touch the sides, top, or bottom of the oven. The foil can damage the oven lining.
- **For better results**, let food stand after defrosting. (For more information on standing time, see the "Microwave Cooking Tips" section.)
- **Turn over** food during defrosting or standing time. Break apart and remove food as required.

OPERATION

Using Quick Touch

Your oven's menu has been preprogrammed to cook food automatically. Tell the oven what you want. Then let your microwave oven cook your selections.

POPCORN

Popcorn lets you pop 3.0, and 3.5 ounce bags of commercially packaged microwave popcorn. Pop only one package at a time. If you are using a microwave popcorn popper, follow manufacturer's instructions. To set your microwave oven correctly, follow this chart:

Example: To pop a 3.0 oz. bag.

Touch: **Display Shows:**

POPCORN 3.0

once for 3.5 oz
twice for 3.0 oz

Time counting down and
COOK.

When the cook time is over,
you will hear four beeps and **End** will display.

PIZZA

Pizza lets you reheat up to 3 slices of pizza. A slice is based on a 5 ounce slice.

NOTE:

- Place on a low plate & paper towel.
- Do not cover.

Example: To reheat 2 slices of Pizza.

Touch: **Display Shows:**

PIZZA 2

once for 1 slice
twice for 2 slices
three times for 3 slices

Time counting down and
COOK.

When the cook time is over,
you will hear four beeps and **End** will display.

FROZEN ENTREE

Frozen Entree lets you cook 10 and 20 ounce plates of commercially packaged microwave frozen entree without entering cooking times and power levels. Remove tray from outer carton. Do not remove film cover, but cut it to vent.

Example: To reheat a 20 oz. frozen entree.

Touch: **Display Shows:**

FROZEN ENTREE 20 0 2

once for 10 oz
twice for 20 oz

Time counting down and
COOK.

When the cook time is over,
you will hear four beeps and **End** will display.

POTATO

The Potato lets you cook potatoes with preset times and cook powers. You can choose from 1 to 4 potatoes.

NOTE:

- Cooking times are based on an average 8 ounce potato.
- Before baking, pierce potato with fork several times.
- After baking, let stand for 5 minutes.

Example: To cook 2 Potatoes.

Touch: **Display Shows:**

POTATO 2

once for 1 potato
twice for 2 potatoes
three times for 3 potatoes
four times for 4 potatoes

Time counting down and
COOK.

When the cook time is over,
you will hear four beeps and **End** will display.

OPERATION

AUTO COOK

Auto Cook provides four preset categories for cooking.

Example: To cook 2 cups of Casserole.

Touch:

Display Shows:

1. **AUTO
COOK**

AC -4

Choose food category.

Category	Touch pad of Time(s)
Fresh vegetable	1
Frozen vegetable	2
Rice	3
Casserole	4

Touch:

Display Shows:

2. 2

Time counting down and
COOK.

Enter quantity/servings.

Category	Number of cups
Fresh vegetable	1 - 4 cups
Frozen vegetable	1 - 4 cups
Rice	1 - 2 cups
Casserole	1 - 4 cups

When the cook time is over,
you will hear four beeps and **End** will display.

COOKING GUIDE FOR AUTO COOK

CODE	CATEGORY	QUANTITY	DIRECTIONS
1	FRESH VEGETABLE	1 cup	Place in a microwavable bowl or casserole. Add water according to the quantity. Cover with vented plastic wrap. Let stand 3 minutes. * 1-2 cups: add 2 tbsp water. * 3-4 cups: add 2 tbsp water.
		2 cups	
		3 cups	
		4 cups	
2	FROZEN VEGETABLE	1 cup	Place in a microwavable bowl or casserole. Cover with vented plastic wrap. Let stand 3 minutes. * 1-2 cups: add 2 tbsp water. * 3-4 cups: add 2 tbsp water.
		2 cups	
		3 cups	
		4 cups	
3	RICE	1 cup	Place in a microwavable bowl or casserole. Cover with vented plastic wrap. Let stand 5 minutes.
		2 cups	
4	CASSEROLE	1 cup	Place in a microwavable bowl or casserole. Cover with vented plastic wrap. Stir and let stand 3 minutes.
		2 cups	
		3 cups	
		4 cups	

COOKING

GETTING THE BEST COOKING RESULTS

To get the best results from your microwave oven, read and follow the guidelines below.

- **Storage Temperature:** Foods taken from the freezer or refrigerator take longer to cook than the same foods at room temperature. The time for recipes in this book is based on the normal storage temperature of the food.
- **Size:** Small pieces of food cook faster than large ones, pieces similar in size and shape cook more evenly. For even cooking, reduce the power when cooking large pieces of food.
- **Natural Moisture:** Very moist foods cook more evenly because microwave energy is attracted to water molecules.
- **Stir** foods such as casseroles and vegetables from the outside to the center to distribute the heat evenly and speed cooking. Constant stirring is not necessary.
- **Turn over** foods like pork chops, baking potatoes, roasts, or whole cauliflower halfway through the cooking time to expose all sides equally to microwave energy.
- **Place** delicate areas of foods, such as asparagus tips, toward the center of the dish.
- **Arrange** unevenly shaped foods, such as chicken pieces or salmon steaks, with the thicker, meatier parts toward the outside of the dish.
- **Shield**, with **Small** pieces of aluminum foil, parts of food that may cook quickly, such as wing tips and leg ends of poultry.
- **Let It Stand:** After you remove the food from the microwave, cover food with foil or casserole lid and let it stand to finish cooking in the center and avoid overcooking the outer edges. The length of standing time depends on the density and surface area of the food.
- **Wrapping in waxed paper or paper towel:** Sandwiches and many other foods containing prebaked bread should be wrapped prior to microwaving to prevent drying out.

Fish & Shellfish

Cooking Fish and Shellfish: General Directions

- Prepare the fish for cooking.
 - Completely defrost the fish or shellfish.
 - Arrange unevenly shaped pieces with thicker parts toward the outside of the dish. Arrange shellfish in a single layer for even cooking.
 - The type of cover you use depends on how you cook. Poached fish needs a microwavable lid or **vented** plastic wrap.
 - Baked fish, coated fish, or fish in sauce needs to be covered lightly with waxed paper to keep the coating crisp and sauce from getting watery.
- Always set the shortest cooking time. Fish is done when it turns opaque and the thickest part begins to flake. Shellfish is done when the shell turns from pink to red and the flesh is opaque and firm.
- The Fish and Shellfish Cooking Table below provides specific directions with Power Level and Cooking Time settings for most types of fish and shellfish.

Fish And Shellfish Cooking Table

FISH	POWER LEVEL	COOKING TIME	DIRECTIONS
Fish fillets	HI	3 1/2-4 1/2 minutes	Arrange fish in a single layer with thickest portion toward outside edge of 1 1/2 quart microwavable baking dish. Brush with melted butter and season, if desired. Cook covered with vented plastic wrap. Let stand covered 2 minutes. If you are cooking more than 1 lb. of fish, turn the fish halfway through cooking.
Fish steaks	HI	4 1/2-5 1/2 minutes	
Whole fish	7	4 1/2-6 minutes	
Scallops	HI	3 1/2-5 minutes	Arrange in a single layer. Prepare as directed above, except stir instead of turning the shellfish.
Shrimp, shelled	HI	3 1/2-5 minutes	

COOKING

Appetizers / Sauces / Soups

Cooking Appetizers: Tips and Techniques

Recommended

- Crisp crackers, such as melba toast, shredded wheat and crisp rye crackers are best for microwave use. Wait until party time to add the spreads. Place a paper towel under the crackers while they cook in the microwave oven to absorb extra moisture.
- Arrange individual appetizers in a circle for even cooking.
- Stir dips to distribute heat and shorten cooking time.

Cooking Sauces: Tips and Techniques

- Use a microwavable casserole or glass measuring cup that is at least 2 or 3 times the volume of the sauce.
- Sauces made with cornstarch thicken more rapidly than those made with flour.
- Cook sauces made with cornstarch or flour uncovered so you may stir them 2 or 3 times during cooking for a smooth consistency.
- To adapt a conventional sauce or gravy recipe, reduce the amount of liquid slightly.

Cooking Soups: Tips and Techniques

- Cook soups in a microwavable dish which holds double the volume of the recipe ingredients to prevent boil-over, especially if you use cream or milk in the soup.
- Generally, cover microwaved soups with VENTED plastic wrap or a microwavable lid.
- Cover foods to retain moisture. Uncover foods to retain crispness.
- Avoid overcooking by using the minimum suggested time. Add more time, if necessary, only after checking the food.
- Stirring occasionally will help blend flavors, distribute heat evenly, and may even shorten the cooking time.
- When converting a conventional soup recipe to cook in the microwave, reduce the liquid, salt, and strong seasonings.

Not Recommended

- Appetizers with a crisp coating or puff pastry are best done in a conventional oven with dry heat.
- Breaded products can be warmed in the microwave oven but will not come out crisp.

Meat

Cooking Meat: General Directions

- Prepare the meat for cooking.
 - Defrost completely.
 - Trim off excess fat to avoid splattering.
 - Place the meat, fat side down, on a microwavable rack in a microwavable dish.
 - Use oven cooking bag for less tender cuts of meat.
 - Arrange the meat so that thicker portions are toward the outside of the dish.
 - Cover the meat with waxed paper to prevent splattering.
- Tend the meat as it cooks.
 - Drain juices as they accumulate to reduce splattering and keep from overcooking the bottom of the meat.
 - Shield thin or bony portions with strips of foil to prevent overcooking.

NOTE: Keep the foil **at least 1 inch** from the oven walls, and do not cover more than one-third of the meat with foil at any one time.

- Let the meat stand covered with foil 10-15 minutes after you remove it from the oven. The internal temperature of the meat may rise from 5-10°F during standing time.

The Meat Cooking Table on the next page provides detailed directions, Power Level, and Cooking Time settings for most cuts of meat.

COOKING

Meat Cooking Table

MEAT	POWER LEVEL	COOKING TIME	DIRECTIONS
Beef Hamburgers, Fresh or defrosted (4 oz. each) 1 patty 2 patties 4 patties	HI	1-1 1/2 minutes 1 1/2-2 minutes 2 1/2-3 1/2 minutes	Form patties with depression in center of each. Place on microwavable roast rack. Brush with browning agent, if desired. Cover with waxed paper. Turn over halfway through cooking. Let stand covered 1 minute.
Sirloin tip roast (3-4 lbs.)	5	8-10 minutes per pound RARE(135°F) 11-13 minutes per pound MEDIUM(155°F)	Place roast fat side down on microwavable roasting rack. Add desired seasonings and cover with waxed paper. Turn meat over halfway through cooking and shield if necessary. Remove roast from microwave oven when desired temperature is reached. Let stand covered with foil 15 minutes.(Temperature may rise about 10°F).
Lamb Lamb roast, rolled boneless (3-4 lbs.)	5	11-12 minutes per pound RARE(135°F) 12-13 minutes per pound MEDIUM(145°F) 13-14 minutes per pound WELL(155°F)	Place roast fat side down on microwavable roasting rack. Brush lamb with marinade or desired seasonings such as rosemary, thyme or marjoram. Cover with waxed paper. Turn roast over after 15 minutes, and again after 30 minutes. Shield if necessary. Remove roast from microwave when desired temperature is reached. Let stand covered with foil 15 minutes (Temperature may rise about 10°F).
Pork Bacon slices 2 slices 4 slices 6 slices 10slices	HI	1 1/2-2 minutes 2-3 minutes 4-5 minutes 7-8 minutes	Place bacon slices on microwavable roasting rack. Cover with paper towels. After cooking, let stand 1 minute.
Chops (5-7 oz. each) 2 chops 4 chops	3	18-20 minutes per pound 15-17 minutes per pound	Place chops in microwavable baking dish. Add desired seasonings and cover with vented plastic wrap. Cook until no longer pink or until internal temperature reaches 170°F. Turn chops over halfway through cooking. Let stand covered 5 minutes. (Temperature may rise about 10°F).
Loin Roast, rolled, boneless (3 1/2- 4 1/2 lbs.)	3	25-27 minutes per pound (165°F)	Place roast in cooking bag in microwavable dish. Add seasonings and browning agent if desired. Close bag loosely with microwavable closure or string. After cooking, let stand in bag 15 minutes. (Temperature may rise about 10°F.) Internal temperature of pork should reach 170°F before serving.
Sausage links, Fresh or Frozen, defrosted (1-2 oz. each) 2 links 4 links 6 links 10 links (8 oz. pkg.)	HI	45-60 seconds 1-1 1/2 minutes 1 1/2-2 minutes 1 3/4-2 minutes	Pierce links and place on microwavable roasting rack. Cover with waxed paper or paper towel. Turn over halfway through cooking. After cooking, let stand covered 1 minute.

COOKING

Poultry

Cooking Poultry: General Directions

- Prepare the poultry for cooking.
 - Defrost completely.
 - Arrange poultry pieces with thicker pieces at the outside edge of the baking dish. When cooking legs, arrange them like the spokes of a wheel.
 - Cover the baking dish with waxed paper to reduce splattering.
 - Use a browning agent or cook with a sauce to give a browned appearance.
- Tend the poultry as it cooks.
 - Drain and discard juices as they accumulate.
 - Shield thin or bony pieces with small strips of aluminum foil to prevent overcooking. Keep foil at **least 1 inch** from the oven walls and other pieces of foil.
- The poultry is done when it is no longer pink and the juices run clear. When done, the temperature in the thigh meat should be 180-185°F.
- Let the poultry stand after cooking covered with foil for 10 minutes.

The Poultry Cooking Table below provides detailed directions, Power Level, and Cooking Time settings for most cuts and types of poultry.

Poultry Cooking Table

POULTRY	POWER LEVEL	COOKING TIME	DIRECTIONS
Chicken pieces (2 ¹ / ₂ -3 lbs).	HI	4 ¹ / ₂ -5 ¹ / ₂ minutes per lb	Wash pieces, shake the water off, and go on with cooking. Place pieces in a single layer in a microwavable baking dish with thicker pieces to the outside. Brush with butter or browning agent and seasonings if desired. Cover with waxed paper. Cook until no longer pink and juices run clear. Let stand covered 5 minutes.
Chicken whole (3-3 ¹ / ₂ lbs)	HI	12-13 minutes per lb	Wash pieces, shake the water off, and go on with cooking. Place breast side down on a microwavable roasting rack. Brush with butter, or browning agent and seasoning if desired. Cover with waxed paper. Cook 1/3 of estimated time. Turn breast side up, brush with butter, or browning agent. Replace waxed paper. Cook 1/3 of estimated time again. Shield if necessary. Cook remaining 1/3 of estimated time or until no longer pink and juices run clear. Let stand covered with foil 10 minutes. (The temperature may rise about 10°F.) The temperature in the high should be 180°F-185°F when the poultry is done.
Cornish Hens Whole (1-1 ¹ / ₂ lbs. each)	HI	6-7 minutes per lb	Wash, shake the water off, and go on with cooking. Tie wings to body of hen and the legs to tail. Place hens breast side down on microwavable rack. Cover with waxed paper. Turn breast side up halfway through cooking. Shield bone ends of drumsticks with foil. Remove and discard drippings. Brush with butter or browning agent and seasonings if desired. Cook until no longer pink and juices run clear. Remove hens from microwave when they reach desired temperature. Let stand covered with foil 5 minutes. (Temperature may rise about 10°F). Temperature in breast should be 170°F before serving.

COOKING

Pasta And Rice

Microwave cooking and conventional cooking of pasta, rice, and cereal require about the same amount of time, but the microwave is a more convenient method because you can cook and serve in the same dish.

There is no stirring needed and leftover pasta tastes just like fresh cooked when reheated in the microwave oven.

Cooking Pasta and Rice: Tips and Techniques

- If you are planning to use rice or pasta in a casserole, undercook it so it is still firm.
- Allow for standing time with rice, but not for pasta.
- The Pasta and Rice Cooking Tables below provide specific directions, with Power Level and Cooking Time settings for most common types of pasta and rice.

Pasta Cooking Table

TYPE OF PASTA	POWER LEVEL	COOKING TIME	DIRECTIONS
Spaghetti 4 cups water. Add 8 oz. spaghetti.	HI 5	9 to 10 minutes 7 1/2 to 8 1/2 minutes	Combine hot tap water and salt, if desired. Use a 2-quart microwavable baking dish and cover with vented plastic wrap for spaghetti and lasagna noodles. Use microwavable lid or vented plastic wrap for macaroni and egg noodles. Cook as directed in chart or until water boils. Stir in pasta; cook covered as directed in chart or until tender. Drain in a colander.
Macaroni 3 cups water. Add 2 cups macaroni.	HI 5	6 to 7 minutes 5 1/2 to 6 1/2 minutes	
Lasagna noodles 4 cups water. Add 8 oz. lasagna noodles.	HI 5	7 to 8 minutes 11 to 12 1/2 minutes	
Egg noodles 6 cups water. Add 4 cups noodles.	HI 5	8 to 10 minutes 5 1/2 to 6 1/2 minutes	

Rice Cooking Table

TYPE OF RICE	POWER LEVEL	COOKING TIME	DIRECTIONS
Long grain 2 1/4 cups water. Add 1 cup rice.	HI 3	3 1/2 to 4 1/2 minutes 18 minutes	Combine hot tap water and salt, if desired, in 2 quart microwavable casserole. Cover with microwavable lid or vented plastic wrap. Cook as directed in chart or until water boils. Stir in rice and any seasonings. Cook covered as directed in chart or until water is absorbed and rice is tender. Let stand covered 5 to 10 minutes. Fluff with fork.
Brown 2 1/2 cups water. Add 1 cup rice.	HI 5	4 1/2 to 5 1/2 minutes 28 minutes	
Long grain and wild rice mix 2 1/3 cups water. Add 6 oz. pkg.	Hi 3	4 to 5 minutes 28 minutes	
Quick cooking 1 cup water. Add 1 cup rice.	HI	2 to 3 minutes	Cook water until it boils. Stir rice into boiling water and let stand, covered 5 to 10 minutes or until water is absorbed and rice is tender. Fluff with fork.

MAINTENANCE

CARE AND CLEANING

For best performance and safety, keep the oven clean inside and outside. Take special care to keep the inner door panel and the oven front frame free of food or grease build-up.

Never use rough powder or pads. Wipe the microwave oven inside and out, including the hood bottom cover, with a soft cloth and a warm(not hot) mild detergent solution. Then rinse and wipe dry. Use a chrome cleaner and polish on chrome, metal and aluminum surfaces. Wipe spatters immediately with a wet paper towel, especially after cooking chicken or bacon. Clean your oven weekly or more often, if needed.

CLEANING THE GREASE FILTERS

The grease filters should be removed and cleaned often, at least once a month.

1. To remove grease filters, slide each filter to the side, then pull filters downward. The filter will drop out.

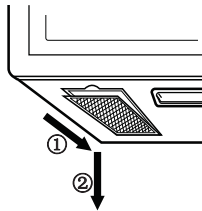

2. Soak grease filters in hot water and a mild detergent. Rinse well and shake to dry. **Do not use ammonia or place in a dishwasher. The aluminum will darken.**

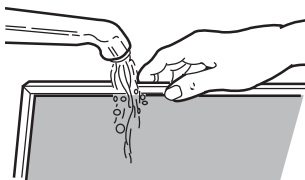

3. To reinstall the filters, slide it into the side slot, then push up and forward to lock.

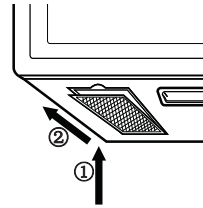

NOTE: Do not operate the hood without the filters in place.

CHARCOAL FILTER REPLACEMENT

If your oven is vented inside, the charcoal filter should be replaced every 6 to 12 months, and more often if necessary. The charcoal filter cannot be cleaned. To order a new charcoal filter, contact the Service Center.

1. Remove the two vent grille mounting screws. (2 outside screws)
2. Tip the grille forward, then lift it out

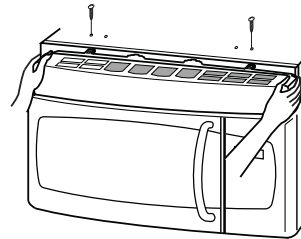

3. Open the door.
4. Push the hook and remove old filter.

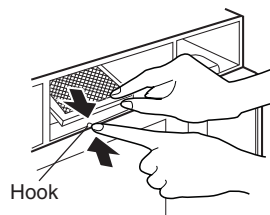

5. Slide a new charcoal filter into place and close the door. The filter should rest at the angle shown and set the clock.

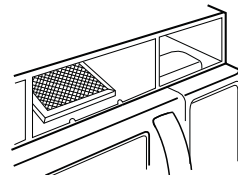

6. Slide the bottom of the vent cover into place. Push the top until it snaps into place. Replace the mounting screws. Turn the power back on at the main power supply and set the clock.

MAINTENANCE

COOKTOP/NIGHT LIGHT REPLACEMENT

1. Unplug oven or turn off power at the main power supply.
2. Remove the bulb cover mounting screws.

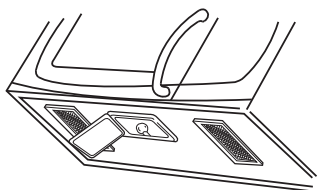

3. Replace bulb with 30 watt appliance bulb.
4. Replace bulb cover, and mount screw.
5. Turn the power back on at the main power supply.

OVEN LIGHT REPLACEMENT

1. Unplug oven or turn off power at the main power supply.
2. Remove the vent cover mounting screws. (2 outside screws)
3. Tip the cover forward, then lift out to remove.

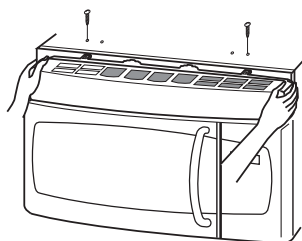

4. Lift up the bulb holder.

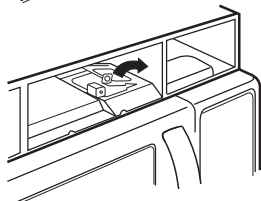
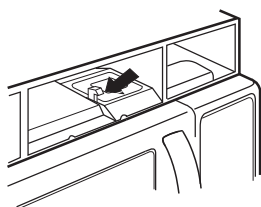

5. Replace bulb with a 30 watt appliance bulb.
6. Replace the bulb holder.
7. Slide the top of the vent cover into place. Push the bottom until it snaps into place. Replace the mounting screws. Turn the power back on at the main power supply.

QUESTIONS AND ANSWERS

Q. Can I use a rack in my microwave oven so that I may reheat or cook in two levels at a time?

- A. Only use the rack that is supplied with your microwave oven. Use of any other rack can result in poor cooking performance and/or arcing and may damage your oven.

Q. Can I use either metal or aluminum pans in my microwave oven?

- A. Usable metal includes aluminum foil for shielding (use small, flat pieces), and shallow foil trays (if tray is 3/4 inch deep and filled with food to absorb microwave energy). Never allow metal to touch walls or door.

Q. Sometimes the door of my microwave oven appears wavy. Is this normal?

- A. This appearance is normal and does not affect the operation of your oven.

Q. What are the humming noises that I hear when my microwave oven is operating?

- A. You hear the sound of the transformer when the magnetron tube cycles on and off.

Q. Why does the dish become hot when I microwave food in it? I thought that this should not happen.

- A. As the food becomes hot it will conduct the heat to the dish. Use hot pads to remove food after cooking.

Q. What does "standing time" mean?

- A. "Standing time" means that food should be taken out of the oven and covered for additional time after cooking. This process allows the cooking to finish, saves energy and frees the oven for other purpose.

Q. Can I pop popcorn in my microwave oven? How do I get the best results?

- A. Yes. Pop packaged microwave popcorn following manufacturer's guidelines or use the preprogrammed Popcorn pad. Do not use regular paper bags. Use the "listening test" by stopping the oven as soon as the popping slows to a "pop" every one or two seconds. Do not try to repop unpopped kernels. You can also use special microwave poppers. When using a popper, be sure to follow manufacturer's directions. Do not pop popcorn in glass utensils.

Q. Why does steam come out of the air exhaust vent?

- A. Steam is normally produced during cooking. The microwave oven has been designed to vent this steam out the top vent.

MAINTENANCE

MICROWAVE UTENSIL GUIDE

USE	DO NOT USE
<p>OVENPROOF GLASS (treated for high intensity heat): utility dishes, loaf dishes, pie plates, cake plates, liquid measuring cups, casseroles and bowls without metallic trim.</p> <p>CHINA: bowls, cups, serving plates and platters without metallic trim.</p> <p>PLASTIC: Plastic wrap (as a cover)-- lay the plastic wrap loosely over the dish and press it to the sides. Vent plastic wrap by turning back one edge slightly to allow excess steam to escape. The dish should be deep enough so that the plastic wrap will not touch the food. As the food heats it may melt the plastic wrap wherever the wrap touches the food. Use plastic dishes, cups, semirigid freezer containers, and plastic bags only for short cooking time. Use these with care because the plastic may soften from the heat of the food.</p> <p>PAPER: Paper towels, waxed paper, paper napkins, and paper plates with no metallic trim or design. Look for the manufacturer's label for use in the microwave oven.</p>	<p>METAL UTENSILS: Metal shields the food from microwave energy and produces uneven cooking. Also avoid metal skewers, thermometers, or foil trays. Metal utensils can cause arcing, which can damage your microwave oven.</p> <p>METAL DECORATION: Metal-trimmed or metal-banded dinnerware, casserole dishes, etc. The metal trim interferes with normal cooking and may damage the oven.</p> <p>ALUMINUM FOIL: Avoid large sheets of aluminum foil because they hinder cooking and may cause harmful arcing. Use small pieces of foil to shield poultry legs and wings. Keep ALL aluminum foil at least 1 inch from the side walls and door of the oven.</p> <p>WOOD: Wooden bowls and boards will dry out and may split or crack when you use them in the microwave oven. Baskets react in the same way.</p> <p>TIGHTLY COVERED UTENSILS: Be sure to leave openings for steam to escape from covered utensils. Pierce plastic pouches of vegetables or other food items before cooking. Tightly closed pouches could explode.</p> <p>BROWN PAPER: Avoid using brown paper bags. They absorb too much heat and could burn.</p> <p>FLAWED OR CHIPPED UTENSILS: Any utensil that is cracked, flawed, or chipped may break in the oven.</p> <p>METAL TWIST TIES: Remove metal twist ties from plastic or paper bags. They become hot and could cause a fire.</p>

MAINTENANCE

BEFORE CALLING FOR SERVICE

Check the following list to be sure a service call is really necessary. A quick reference of this manual as well as reviewing additional information on items to check may prevent an unneeded service call.

If nothing on the oven operates:

- check for a blown circuit fuse or a tripped main circuit breaker.
- check if oven is properly connected to electric circuit in house.
- check that controls are set properly.

If the oven interior light does not work:

- the light bulb is loose or defective.

If oven will not cook:

- check that control panel was programmed correctly.
- check that door is firmly closed.
- check that Start Pad was pressed.
- check that probe was inserted correctly into receptacle.
- check that timer wasn't started instead of a cook function.

If oven takes longer than normal to cook or cooks too rapidly:

- be sure the Power Level is programmed properly.

If the time of day clock does not always keep correct time:

- check that the power cord is fully inserted into the outlet receptacle.
- be sure the oven is the only appliance on the electrical circuit.

If food cooks unevenly:

- be sure food is evenly shaped.
- be sure food is completely defrosted before cooking.
- check placement of aluminum foil strips used to prevent overcooking.

If food is undercooked:

- check recipe to be sure all directions (amount, time, & power levels) were correctly followed.
- be sure microwave oven is on a separate circuit.
- be sure food is completely defrosted before cooking.

If food is overcooked:

- check recipe to be sure all directions (amount, power level, time, size of dish) were followed.

If arcing (sparks) occur:

- be sure microwavable dishes were used.
- be sure wire twist ties weren't used.
- be sure oven wasn't operated when empty.
- make sure metal rack (if used) is properly installed on 4 supports.

If the Display shows a time counting down but the oven is not cooking:

- check that door is firmly closed.
- check that timer wasn't started instead of a cooking function.

GOLDSTAR OVER-THE-RANGE MICROWAVE OVEN LIMITED WARRANTY – USA

LG Electronics Inc. will repair or replace your product, at LG's option, if it proves to be defective in material or workmanship under normal use, during the warranty period set forth below, effective from the date of original consumer purchase of the product. This limited warranty is good only to the original purchaser of the product and effective only when used in the United States, including U.S. Territories.

<p><u>WARRANTY PERIOD:</u></p> <p>Model: MV1611WW/BB/ST</p> <p>Labor: 1 Year from the Date of Purchase.</p> <p>Parts: 1 Year from the Date of Purchase.</p> <p>Magnetron: 10 Years from the Date of Purchase.</p>	<p><u>HOW SERVICE IS HANDLED:</u></p> <p>Call 1-800-243-0000 and choose the appropriate prompt. Please have product type (Microwave) and ZIP code ready.</p>
---	---

THIS WARRANTY IS IN LIEU OF ANY OTHER WARRANTIES, EXPRESS OR IMPLIED, INCLUDING WITHOUT LIMITATION, ANY WARRANTY OF MERCHANTABILITY OR FITNESS FOR A PARTICULAR PURPOSE. TO THE EXTENT ANY IMPLIED WARRANTY IS REQUIRED BY LAW, IT IS LIMITED IN DURATION TO THE EXPRESS WARRANTY PERIOD ABOVE. LG WILL NOT BE LIABLE FOR ANY CONSEQUENTIAL, INDIRECT, OR INCIDENTAL DAMAGES OF ANY KIND, INCLUDING LOST REVENUES OR PROFITS, IN CONNECTION WITH THE PRODUCT. SOME STATES DO NOT ALLOW LIMITATION ON HOW LONG AN IMPLIED WARRANTY LASTS OR THE EXCLUSION OF INCIDENTAL OR CONSEQUENTIAL DAMAGES, SO THE ABOVE LIMITATIONS OR EXCLUSIONS MAY NOT APPLY TO YOU.

THIS LIMITED WARRANTY DOES NOT APPLY TO:

1. Service trips to your home to deliver, pick up, and/or install the product, instruct, or replace house fuses or correct wiring, or correction of unauthorized repairs; and
2. Damages or operating problems that result from misuse, abuse, operation outside environmental specifications or contrary to the requirements or precautions in the Operating Guide, accident, vermin, fire, flood, improper installation, acts of God, unauthorized modification or alteration, incorrect electrical current or voltage, or commercial use, or use for other than intended purpose.
3. **Therefore, the cost of repair or replacement of such a defective product shall be borne by the consumer.**

CUSTOMER INTER-ACTIVE CENTER NUMBERS:

<p>To Prove Warranty Coverage</p>	<p>Retain your Sales Receipt to prove date of purchase. A copy of your Sales Receipt must be submitted at the time warranty service is provided.</p>
<p>To Obtain Nearest Authorized Service Center or Sales Dealer, or to Obtain Product, Customer, or Service Assistance</p>	<p>Call 1-800-243-0000 (Phone answered 24 hours - 365 days a year) and choose the appropriate prompt from the menu; or visit our website at: http://us.lgservice.com.</p>

