

## Coyote Stainless Steel Gas Grill Use & Care Manual

*For Liquid Propane and Natural Gas Models*

### Built-in Models

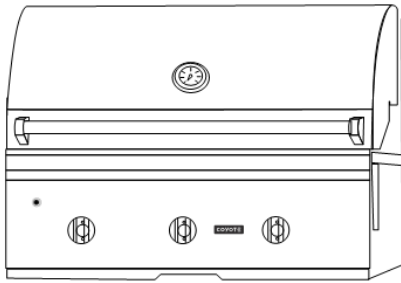

Coyote 34" CCX3

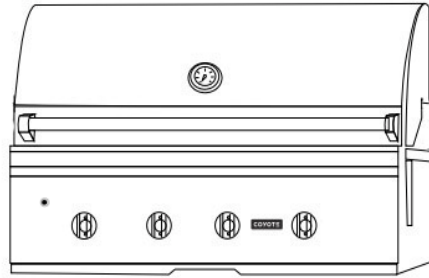

Coyote 36" CCX4

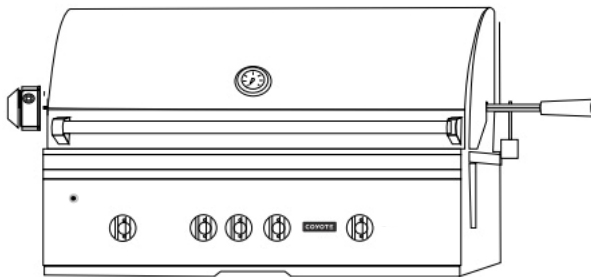

Coyote 36" CSX36 / CSLX36

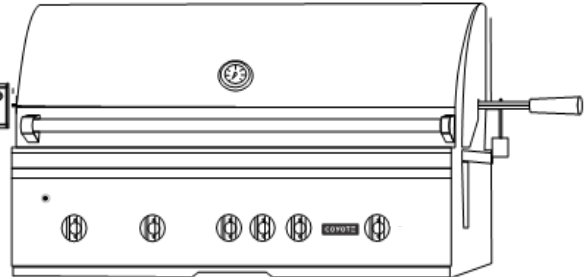

Coyote 42" CSLX42NG



Conforms to ANSI STD Z21.58b-2012  
Certified to CSA STD 1.6b-2012  
Outdoor Cooking Gas Appliance

**For Outdoor Use Only**

PUT SERIES NO. LABEL HERE

**IMPORTANT:** Read the lighting instruction on Page 20 before first time use!

**To installer or person assembling grill:** Leave this manual with grill for future reference.

**To consumer:** Keep this manual for future reference.

---

**COYOTE OUTDOOR LIVING, INC.**  
[www.coyoteoutdoor.com](http://www.coyoteoutdoor.com)

---

## **Welcome & Congratulations**

Congratulations on your purchase of a new grill! We are very proud of our product and we are completely committed to providing you with the best service possible. Your satisfaction is our #1 priority.

Please read this manual carefully to understand all the instructions about how to install, operate and maintain for optimum performance and longevity.

We know you'll enjoy your new grill and thank you for choosing our product. We hope you consider us for future purchases.

### **Please read and save the instructions**

This Manual provides specific operating instructions for your model. Use your grill only as instructed in this manual. These instructions are not meant to cover every possible condition and situation that may occur. Common sense and caution must be practiced when installing, operating and maintaining any appliance.

## Table of Contents

Safety Instructions.....	2
Grill Models .....	4
Locating the Grill.....	5
Gas Requirements .....	8
Using Your Burners & Grilling.....	14
Lighting Your Grill.....	19
Operation and Features.....	21
Care & Maintenance.....	22
Troubleshooting Your Grill.....	26
Limited Warranty.....	28
Parts Listings.....	30

## Safety Symbols

• **WARNING** 

**DANGER** indicates an imminently hazardous situation which, if not avoided, will result in death or serious injury.

• **CAUTION** 

**CAUTION** indicates a potentially hazardous situation which, if not avoided, may result in minor or moderate personal injury, or property damage.

• **WARNING** 

**WARNING** indicates a potentially hazardous situation which, if not avoided, could result in death or serious injury.

• **WARNING** 

**IF YOU SMELL GAS:**

1. Shut off gas to the appliance.
2. Extinguish any open flame.
3. Open Lid.
4. If odor continues, keep away from the appliance and immediately call your gas supplier or your fire department.

• **WARNING** 

**WARNING:**

1. DO NOT store or use gasoline or other flammable liquids or vapors in the vicinity of this or any other appliance.
2. An LP cylinder not connected for use shall not be stored in the vicinity of this or any other appliance.

• **WARNING** 

**FOR OUTDOOR USE ONLY:**

NEVER operate grill in enclosed areas, as this could lead to gas accumulating from a leak, causing an explosion or a carbon monoxide buildup which could result in injury or death. DO NOT use your grill in garages, breezeways, sheds or any enclosed area. NOT FOR USE BY CHILDREN. If these instructions are ignored, a hazardous fire or explosion could result in physical injury, death or property damage!

# Safety Instructions

**WARNING:** Improper installation, adjustment, alteration, service or maintenance can cause injury or property damage. Read the installation, operating and maintenance instructions thoroughly before installing or servicing this equipment.

## General Safety Instructions

1. For Household Outdoor Use Only – DO NOT use indoors or in any type of enclosed area such as a garage, shed or breezeway. Keep clear of trees and shrubs. The grills are not intended for installation in or on recreational vehicles, portable trailers, boats or any other moving installation. Not for commercial use.
2. The area surrounding your new grill should be kept clean and free from flammable liquids and other combustible materials such as mops, rags or brooms, as well as solvents, cleaning fluids, and gasoline.
3. To reduce the risk of serious or fatal injury from breathing toxic fumes and from explosion and fire as a result of leaking gas, use only outdoors in an open area with good ventilation. Do not obstruct the flow of combustion and ventilation air.
4. Never use the grill in windy conditions. If located in a consistently windy area (oceanfront, mountaintop, etc.) a wind break will be required. Always adhere to the specified clearances listed.
5. Do not leave the grill unattended while cooking.
6. Do not use natural gas in a unit designed for liquid propane gas or vice versa.
7. Do not use fuel such as charcoal briquettes in a gas grill.
8. Keep children and pets away from hot grill. DO NOT allow children to use or play near the grill.
9. Never attempt to repair or replace any part of the grill yourself unless specifically recommended in this manual. All other services should be performed by a qualified service technician.
10. Never lean over an open grill. Do not place clothing or other flammable material on or near the grill. Do not wear loose-fitting clothes or long sleeves while using the grill as some fabrics can be highly flammable.
11. Have an ABC fire extinguisher accessible. Never attempt to extinguish a grease fire with water or other liquids.
12. Never use aluminum foil to line the grill racks or the drip trays, this can alter airflow for proper combustion and also build up heat in the control area causing the knobs and igniter to melt.
13. When using the grill, do not touch the grill rack, burner grate, or immediate surroundings as these areas become extremely hot and can cause burns. Always use a covered hand when opening the grill hood and only do so slowly to allow heat and steam to escape.
14. DO NOT allow grease or other hot material dripping from the grill onto valve, hose or regulator, turn off gas supply immediately. After the grill has cooled, determine the cause and correct it. After cleaning the valve, hose and regulator, perform a leak test before continuing use.
15. Do not heat any unopened glass or metal container of food on the grill. Pressure may build up and cause the container to burst, possibly resulting in serious personal injury or damage to the grill.
16. Keep any electrical supply cords away from water or heated surfaces. Electrical cords should be placed away from walkways to avoid tripping hazard.
17. Keep gas supply lines as short as possible.
18. Never move the grill when hot.
19. DO NOT use while under the influence of drugs or alcohol.
20. DO NOT store a spare gas cylinder under or near your grill.
21. DO NOT grill without the drip tray in place, hot grease could leak downward and produce a fire or an

- explosion. Drip tray should be pushed all the way to the rack located just under the grill.
22. Grease is extremely flammable. Let hot grease cool down before attempting to handle or dispose of it. The drip tray should be cleaned and free of grease on a regular basis.
  23. In the event that a burner goes out, turn burner knobs to the full OFF position, fully open the grill hood and let it air out. Do not attempt to use the grill until the gas has had time to dissipate.
  24. Do not use grill until leak check has been made.
  25. Turn off the cylinder valve when your grill is not in use.
  26. Ensure the control knobs are in the "OFF" position when not in use.
  27. Use only a Ground Fault Interrupter (GFI) protected circuit with this outdoor cooking gas appliance.

**CALIFORNIA PROPOSITION 65 - WARNING:** The burning of gas cooking fuels generates some byproducts which are on the list of substances which are known by the State of California to cause cancer or reproductive harm. California law requires businesses to warn customers of potential exposure to such substances. To minimize exposure to these substances, always operate this unit according to the Use and Care Manual, ensuring you provide good ventilation when cooking with gas.

# Grill Models

Whether you are in need of a slimmer 3 Burner grill for your patio, or are in need of a larger 42" grill, that can entertain and bring style to any size party, Coyote has the grill for you!

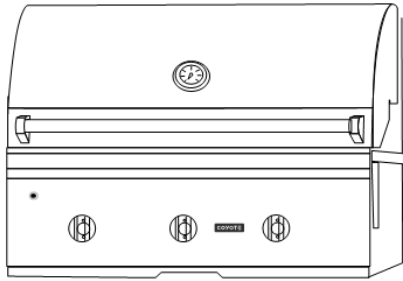

**Coyote 34" CCX3**

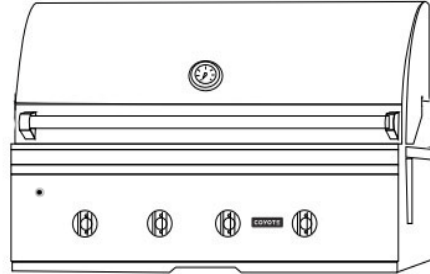

**Coyote 36" CCX4**

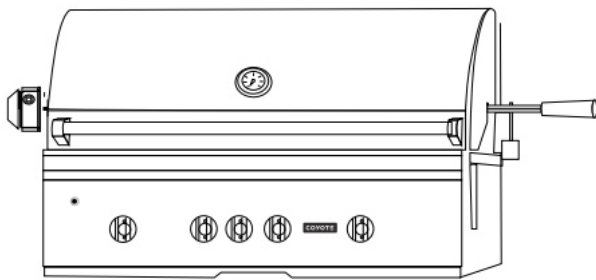

**Coyote 36" CSX36 / CSLX36**

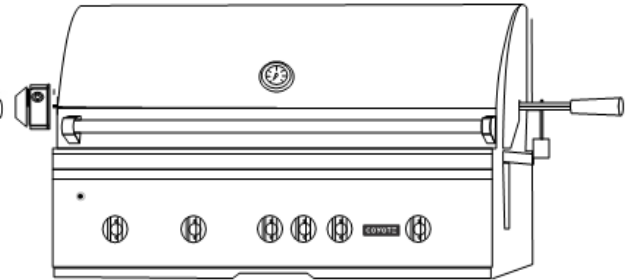

**Coyote 42" CSLX42NG**

Model No.	Product Size (inch/mm)	BTU/HR (Main/Back)	Burner(s)	Rotisserie Motor	Hood Light
CCX3	34" (863)	60,000/None	3 SUS burners	No	Yes
CCX4	36" (902)	80,000/None	4 SUS burners	No	Yes
CSX36 / CSLX36	36" (902)	80,000/15,000	3 SUS burners, 1 sear and 1 back burner	Yes	Yes
CSLX42	42" (1067)	100,000/15,000	4 SUS burners, 1 sear and 1 back burner	Yes	Yes

# Locating the Grill

Check your local building codes for the proper method of installation. In the absence of local codes, this unit should be installed in accordance with the *National Fuel Gas Code No. Z223.1-1998 USA* or *CAN/CGA-B149.1/2 Natural Gas/Propane Code (Canada)* latest edition or the *National Electrical Code ANSI/NFPA No. 70* or the *Canadian Electrical Code CSA C22.1, 1990* or latest version.

- Before installing built-in grills in enclosures, copy all product information such as model number, serial number and type of grill (e.g. natural gas or LP) and store information in a safe place.
- If the grill is installed by a professional installer or technician, be sure that he shows you where your gas supply shut-off is located. All gas lines must have a shut-off that is readily and easily accessible. If you smell gas, check for gas leaks immediately. Check only with a soap and water solution. Never check for gas leaks with an open flame.

**Notice:** We strongly recommend professional installation and hookup of the Gas BBQ grill. These instructions will provide you with the measurements necessary for you or your builder to construct a masonry structure to house your outdoor gas grill.

**IMPORTANT:** Gas fittings, regulator, and installer supplied shut-off valves must be easily accessible.

## **LOCATION OF YOUR GRILL:**

Locate the grill only in a well ventilated area. Never locate the grill in a building, garage, breezeway, shed or other such enclosed areas without an approved ventilation system. During heavy use, the grill will produce a lot of smoke. Ensure there is adequate area for it to dissipate.

## **Ventilation Requirements for Proper Operation of your Coyote Grill**

- Ventilation for a gas grill is absolutely mandatory to ensure that your grill performs as intended and to ensure the safety of you and your family. The vents that are required to honor a Coyote warranty, not only ensure that any heat that is trapped inside your grill from environmental factors (such as wind) escape but they also allow any gas that has leaked from a tank or connection, to escape before a buildup of such gas can occur and possibly ignite.
- A simple way to think of what is occurring inside your grill is that when your burners are on, they are emitting a flame that creates the heat to cook your food. This heat must exhaust from the grill, otherwise you would eventually have a unit that would not only build up immense heat but also immense pressure. This could cause severe damage to not only the grill but any operators or property near by. With that said, if you have wind coming into the back of your unit, the problem will not be with the wind hitting your flames and causing them to push the flame downward. The problem actually lies with the wind acting as a block for the exhaust, which is mainly out the back of the hood (above the rear panel but below the top of the hood). This blockage of exhaust is what starts the problems.
- If the island is ventilated properly (with a minimum of 2 vents for cross ventilation and at least 20 sq in on each vent) then any heat that is trapped inside due to wind should be able to dissipate out of the island vents. However, if the island is not ventilated properly and the wind is coming from the back, then the heat will try to escape through the easiest exit, which will most likely be through the bottom of the grill and front control panel. This can cause the control panel and knobs to get hot to the touch and possibly even burn your fingers, not to mention that it can melt all rubber gaskets on the valves

and damage the ignition system to where it will need full replacement.

- Ventilation and the variable of your most common wind direction must always be considered when planning your outdoor cooking island. Just the same as you would plan the layout and measure your indoor kitchen, you must also do the same for the outdoors but you can not forget about Mother Nature and the effects she can have on your outdoor cooking equipment.
  - **Coyote Wind Guards:** If you do run into a situation where you will have wind coming into the back of the unit, Coyote does sell "Wind Guards" that help keep your grill from overheating due to no exhaust occurring out the back of the grill. Our Wind Guards should never be considered as a guaranteed solution to this problem. They are only intended to help the wind divert up and over the top of the grill. If the wind is strong, then you can still have problems with the heat being trapped in the hood. Our Wind Guards can be purchased through any of our authorized dealers.

### **Clearance:**

- **TO NON-COMBUSTIBLE CONSTRUCTION:** For non-combustible material, Coyote grills can be placed directly on, or adjacent to the non-combustible material. The hood on a Coyote grill pivots mainly on the body. If you have a wall or partition behind the unit that would block ventilation, then a minimum of 7" clearance from the back of the grill to the wall is needed for the purpose of ventilation. If you do not have a wall or partition blocking the ventilation of the unit, then you only need an extra 2" behind the unit for the hood to open fully. If you wish to use the rotisserie option, you will want to make sure that you leave adequate space (at least 6") on each side of the grill so that the motor and rotisserie spit handle will have room on the counter, as these extend past the overall dimensions of the grill body.
- **CLEARANCE TO COMBUSTIBLE CONSTRUCTION:** For combustible construction, you must have at least 24" clearance to any combustible material (in any direction) for a Coyote Warranty to be upheld and for the safety of the homeowner. You can NOT locate the grill under any combustible material without an approved ventilation system directly located above the unit.
- **INSULATED JACKETS AND COMBUSTIBLE CONSTRUCTION:** If you must use combustible material to build your grill island AND you are going to be within 24" of the grill with this combustible material, then you must use the appropriate Coyote Insulated Jacket. The insulated jacket will act as a barrier to protect your grill island from the heat and fire of your Coyote grill. If an insulated jacket is not used in a combustible material island, the warranty on the Coyote grill will be voided immediately and safety can not be ensured.

### **For Built-in Installations**

A built-in grill is designed for easy installation into masonry enclosures. For non-combustible applications, the grill drops into the opening (as shown in cut-out detail drawing - Fig. A) and hangs from the grill body itself. A bottom deck is not required to support the grill from the bottom. It is also required that:

- Two ventilation holes, of at least 20 sq inches in size, must be present to help release any gas from a leak.
  - ◆ As Propane is heavier than air, locate your vents at the tank valve height or lower
- The counter should be flat and level in reference to the floor.

***LP TANK STORAGE MUST BE ISOLATED IN A SEPARATE COMPARTMENT FROM THAT OF THE GRILL AND IT MUST BE VENTED AS WELL. (RECOMMEND BOTTOM VENTS FOR LP)***



## Cut out Dimensions Figure A

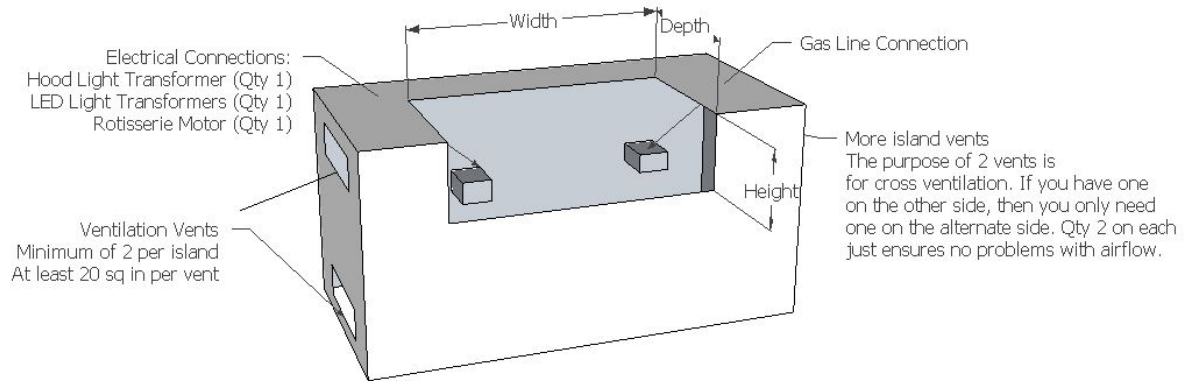

Model	Cutout Dimensions			Overall Dimensions			Total BTU Ratings		Electrical Outlets Needed (110V)	
	Height	Width	Depth	Height	Width	Depth	LP	NG	Rotisserie	Lights
CCX3	11"	31"	20 1/2"	22 1/2"	34"	23 3/4"	60,000	60,000	No	Qty 1
CCX4	11"	32 1/2"	20 1/2"	22 1/2"	35 1/2"	23 3/4"	80,000	80,000	No	Qty 1
CSX36	11"	32 1/2"	20 1/2"	22 1/2"	35 1/2"	23 3/4"	95,000	95,000	Qty 1	Qty 1
CSLX36	11"	32 1/2"	20 1/2"	22 1/2"	35 1/2"	23 3/4"	95,000	95,000	Qty 1	Qty 2
CSLX42	11"	39 1/2"	20 1/2"	22 1/2"	42"	23 3/4"	115,000	115,000	Qty 1	Qty 2

# Gas Requirements

**NOTE:** Always have a qualified service technician perform difficult conversions or modifications.

**WARNING:** Never attach an unregulated gas line to the appliance. Connection to an unregulated gas line can cause excessive heat or fire.

**IMPORTANT:** Before connecting grill to gas source, make sure BBQ Grill control knobs are in the “OFF” position.

- Verify the type of gas supply to be used, either natural or LP, and make sure the marking on the appliance rating label agrees with that of the supply.
- All pipe sealants must be an approved type and resistant to the actions of LP gas. Never use pipe sealant on flare fittings.
- *The installation of this appliance must conform with local codes or, in the absence of local codes, with either National Fuel Gas Code, ANSI Z223.1/ NFPA 54, Natural Gas and Propane Installation Code, CSA B149.1, or Propane Storage and Handling Code, B149.2, or the Standard for Recreational Vehicles, ANSI A 119.2/ NFPA 1192M, and CSA Z240 RV Series, Recreational Vehicle Code, as applicable.*

**WARNING:** Gas valves are preset at the factory to operate on LP or natural gas. If you wish to convert, be sure to contact your grill dealer FIRST!

## LP Gas Hook-up

This propane gas grill is designed to operate on propane gas ONLY, at a pressure regulated at 11” (279.4mm) water column (W.C.) when equipped with the correct propane orifices on the valves and a propane regulator on the supply line regulated at the residential meter. The LP gas grill is designed to be used with a standard 20 lbs gas cylinder and must be constructed and marked in accordance with specifications of the US Department of Transportation for propane gas cylinders.

Always keep cylinder securely fastened in an upright position. Never connect an unregulated propane gas cylinder to the grill.

Do not subject propane cylinders to excessive heat.

**CAUTION:** Never store a LP gas cylinder inside a building or in the vicinity of any gas-burning appliance.

### **Cylinder Specifications**

- Any L.P. gas supply cylinder used with this grill must be approximately 12 inches diameter and 18 inches high. The maximum fuel capacity is 80% and is approximately 20 pounds of propane.
- The L.P. cylinder must have a shut-off valve (see picture) terminating in a Type 1 L.P.
- A Type 1 compatible cylinder with a Type 1 cylinder valve has a back-check valve which does not permit

gas flow, until a positive seal has been obtained.

- The cylinder must be arranged for vapor withdrawal. It must also include a collar to protect the cylinder valve. A safety relief device having direct communication with the vapor space of cylinder must be provided. This will expel high pressure gas if the cylinder is overfilled or overheated which could result in fire or explosion.
- All L.P. gas cylinders used with this appliance shall be constructed and marked in accordance with the specifications for L.P. gas cylinders of the U. S. Department of Transportation (DOT) or the *National Standard of Canada, CAN/CSA-B339*, Cylinders, Spheres and Tubes for Transportation of Dangerous Goods; and Commission, as applicable; and shall be provided with a listed overfilling prevention device.
- Read labels on the L.P. Gas Supply Cylinder.
- New cylinders are always shipped empty for safety.
- Allow only qualified L.P. gas dealers to fill or repair your L.P. gas supply cylinder.
- Inform the gas dealer if it is a new or used cylinder to be filled.
- After filling, have the gas dealer check for leaks and to see that the relief valve remains free to function.

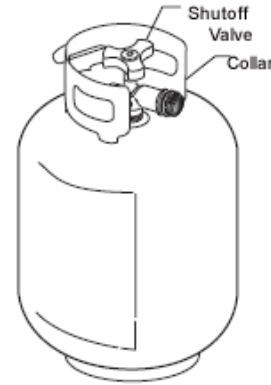

### **Hose and Regulator (Comes standard with the grill)**

The Type 1 connection system has the following features:

- The system will not allow gas to flow until a positive connection has been made.  
**NOTE: The cylinder control valve must be turned off before any connection is made or removed.**
- The system has a thermal element that will shut off the flow of gas in the event of a fire.
- The system has a flow limiting device which, when activated, will limit the flow of gas to 10 cubic feet per hour.
- **NEVER** use grill without leak testing this connection.

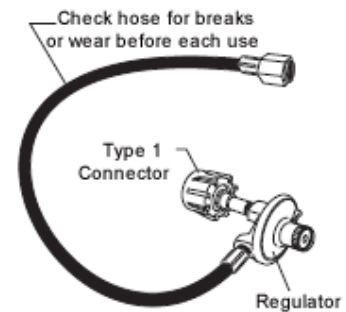

### **LP (Propane) Gas Supply Connection**

1. The tank valve should be in the "OFF" position. If not, turn the knob clockwise until it stops.
2. Make sure all burner valves are in the "OFF" position.
3. Always connect the gas supply regulator as follows:  
Insert the regulator inlet into the tank valve and turn the coupling nut clockwise until the coupler tightens up (see picture). Do not over tighten the coupler. Turn the main tank valve on and turn the burner control valves on the unit to the "HIGH" position for about 20 seconds to allow the air in the system to purge before attempting to light the burners.



## **Pre-Operation Leak Testing**

### **DANGER**

1. Do not insert any tool into the valve outlet or safety relief valve. You may damage the valve and cause a leak. Leaking propane may result in explosion, fire, severe personal injury, or death.
2. If a leak is detected at any time or you cannot stop a gas leak, immediately close pipeline valve and call LP gas supplier or you fire department!
3. Check all gas supply fittings before each use and each time the gas supply cylinder is connected to the regulator. Have a qualified service technician leak test the grill any time a part of the gas system is replaced.

### **WARNING**

Never attempt to attach this grill to the self-contained LP gas system. Do not use grill until leak testing.

### **Before Testing**

DO NOT smoke while leak testing. Extinguish all open flames. Never leak test with an open flame. Mix a solution of equal parts mild detergent or liquid soap and water.

### **Leak Testing Valves, Hose and Regulator**

1. Turn all grill control knobs to OFF.
2. Be sure hose is tightly connected to LP tank.
3. Completely open LP tank valve by turning cylinder valve knob counterclockwise (right to left). If you hear a rushing sound, turn gas off immediately. There is a major leak at the connection. Correct before proceeding by calling franchiser for replacement parts.
4. Brush soapy solution onto areas where bubbles are shown in LP tank (see picture).
5. If "growing" bubbles appear, there is a leak. Close LP tank valve immediately and retighten connections. If leaks cannot be stopped do not try to repair. Call franchiser for replacement.
6. Always close LP tank valve after performing leak test by turning cylinder valve knob clockwise.

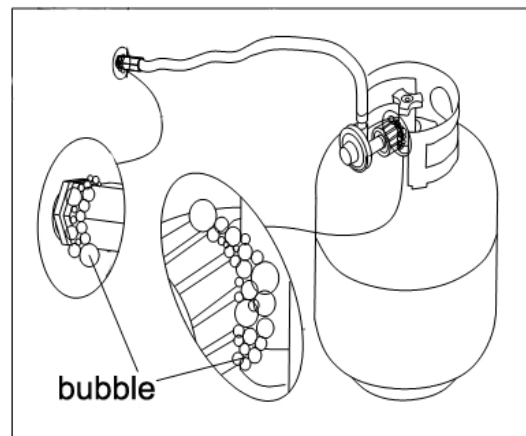

**NOTE:** When leak testing this appliance, make sure to test and tighten all loose connections, including the side burner. A slight leak in the system can result in a low flame, or a hazardous condition.

### **LP Gas Supply Cylinder Disconnection**

1. Turn the burner valves off.
2. Turn the tank valve off. (Turn clockwise to stop).
3. Detach the regulator assembly from the tank valve by turning the quick coupling nut counterclockwise.

## LP Tank Removal, Transport and Storage

- Turn OFF all control knobs and LP tank valve. Turn coupling nut counterclockwise by hand only - do not use tools to disconnect. Lift LP tank wire upward off of LP tank collar, then lift LP tank up and off of support bracket. Install safety cap onto LP tank valve. Always use cap and strap supplied with valve. Failure to use safety cap as directed may result in serious personal injury and/or property damage.
- A disconnected LP tank in storage or being transported must have a **safety cap** installed (as shown). Do not store an LP tank in enclosed spaces such as a carport, garage, porch, covered patio or other building. Never leave a LP tank inside a vehicle which may become overheated by the sun.
- Do not store LP tank in an area where children play.

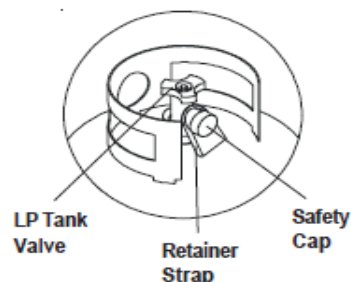

## LP Tank Filling

- Use only licensed and experienced dealers.
- LP dealer must purge tank before filling.
- Dealer should NEVER fill LP tank more than 80% of LP tank volume. Volume of propane in tank will vary by temperature.
- A frosty regulator indicates gas overfill. Immediately close LP tank valve and call local LP gas dealer for assistance.
- Do not release liquid propane (LP) gas into the atmosphere. This is a hazardous practice.
- To remove gas from LP tank, contact an LP dealer or call a local fire department for assistance. Check the telephone directory under "Gas companies" for nearest certified LP dealers.

## LP Tank Exchange

- Exchange your Type 1 cylinder with OPD safety feature-equipped ONLY.
- Always keep new and exchanged LP tanks in upright position during use, transit or storage. Leak test new and exchanged LP tanks BEFORE connecting to grill.

## Large Capacity Propane Tanks and Homes:

- LP (Liquid Propane) Coyote Grills can be installed into propane fueled houses. Meaning that if your entire house is plumbed for propane and you have an exterior connection for such use, then a standard LP grill from Coyote will meet your needs, regardless of the size. Any appliance can be installed if installed properly! That is the Coyote way!
  - Coyote does not supply any gas fittings or lines, other than the regulator needed within the grill box
  - All Coyote LP Grills come with a 20lb tank regulator. This regulator can not be used or modified to work on any other setup.
    - If you are running off of a large capacity tank (more than 20lbs), then an "in-line" LP regulator is needed, Coyote Customer Service must be contacted to assist with this situation.
  - As counties vary from state to state, it is upon the owner/installer to ensure that all county, state and federal codes are followed for any gas installation.

## Natural Gas Hook-up

Always check the rating plate to make sure the gas supply you are hooking up to is the gas type the grill is manufactured for.

This natural gas grill is designed to operate on natural gas ONLY, at a pressure regulated at 4" (101.6mm) water column (W.C.) when equipped with the correct natural gas orifices on the valves and a natural gas regulator on the supply line regulated at the residential meter.

**IMPORTANT:** Never connect the grill to an unregulated gas supply.

Natural gas connections must be performed by a licensed contractor or local gas company representative.

### Natural Gas Hose and Regulator

**IMPORTANT: NEVER** use grill without leak testing this connection.



Natural gas regulator model: GR120

Gas pressure: 4" (101.6mm)

Maximum rate working pressure: 1/2 Psig

### Natural Gas Supply and Connection

1. Make sure all burner valves are in the "OFF" position
2. All NG units need to have a regulator and shut-off valve on the supply line.
3. All Pipe threads need to have proper, gas rated, outdoor rated thread sealant. Flare ends do not need or utilize pipe sealant.
4. Your NG Coyote grill comes with a 1/2" regulator, along with a 18" black hose.
  - a) You need to seal the regulator to the hose using your pipe sealant.
  - b) Then attach the flare end to your manifold line, with no pipe sealant.
  - c) Next, attach your next connection hose (not included) to the other side of the NG regulator (it is also 1/2" MIP)
    - i. We suggest using 1/2" stainless steel corrugated hoses for all NG Grills
    - ii. Make sure that you purchase a hose of adequate length and capacity for the intended application.
  - d) Connect the other end of this hose, to your shut off valve
    - i. Depending on your choice of hose and shut-off, the nipple going into the shut-off valve may vary.
  - e) Test all connections for leaks with a soap and water solution.

## **High Elevation Installation and Use**

Coyote Grills are designed to operate most efficiently at 0-2000 feet above sea level. From 2000-4000 feet above sea level you will not notice any substantial decrease in your heat, although more gas is combusting within the burners due to less oxygen. Above 4000 feet, you may experience a little longer cooking time on your grill than you would experience at sea level. But again, this is just due to the air/fuel mixture taking place within the burners. If any problems or concerns exist about your location or elevation, please contact Coyote Customer Service for assistance.

## **Gas Conversions – Natural Gas and Propane**

Coyote grills are able to be converted but you must obtain the correct conversion kit and we always recommend that any gas appliance conversion should always be performed by a Licensed Plumber or a certified Installer. Conversion kits are sold for Coyote grills and can be purchased through your dealer, or Coyote's Customer Service Department. Any other kit or orifices used that are not of Coyote brand, will automatically void any warranty on the unit. Furthermore, it is important to understand that where ever there is a burner, there is an orifice that will need to be changed (do not forget the rotisserie or sear burner).

### **The steps for converting your Coyote grills main and sear burners are:**

1. Pull grill out of island or cart.
2. Remove Drip Pan and Cooking Grates
3. Unscrew bolt connecting the manifold pipe to the grill body, located at the back side of the grill.
4. Unscrew the 4 bolts holding the faceplate to the body (on the front edge where your cooking grate sits)
5. Unscrew the 2 bolts (on each side) of the manifold and faceplate assembly, that holds this entire assembly to the body of the grill.
6. Disconnect all wires and flex lines, from the valves and igniter assembly while paying close attention to their original location.
7. Slide entire control panel and valve assembly out from the grill body.
8. Flip control panel over on its side, so you have easy access to the valves.
9. **Sear Burner Grills Only** – Remove center knob, unscrew top and bottom screws only.
  - a. The safety valve that controls the thermocouple on your sear burner must be completely changed. You cannot change only the orifice.
10. **Sear Burner Grills Only** – Unscrew base bracket, hold center valve to gas manifold pipe and remove valve
11. **Sear Burner Grills Only** – Install new Safety Valve in the correct gas type and follow the removal instructions in reverse.
12. Once the panel is flipped over, you will see the orifice at the end of the valve. With a wrench remove the orifice from the valve and install the new gas orifice,
13. Re-assemble in reverse and test all connections again with a soapy water solution to ensure no leaks.

### **To convert your rear burner orifice:**

1. Remove your entire rotisserie assembly
2. Remove the back panel that covers your rear rotisserie burner
  - a. With the hood open, remove the 4 screws on top of this panel
  - b. With the hood closed, remove the 4 screws on the back of this panel
  - c. With the hood closed, look underneath this same back panel and you will see 4-5 bolts (depending on your grill), these only need to be loosened
3. Next, pull the entire panel (starting from the back) out from the grill
  - a. It is designed to fit tight, so you may need a flat head screwdriver to pop the stainless away from the body
4. Next, you will see the gas line, brass elbow and orifice
5. Use a wrench to remove the orifice and install the new one
6. Re-assemble in reverse and check your back burner to ensure proper ignition and burning

# Using Your Burners and Grilling Safely

Your grill is designed to reach a temperature that you set by adjusting a valve that in turns adjusts the amount of gas that goes through each burner. This Valve is located behind your knob and is the key to your heat and fuel consumption. An example being: Cooking on low will give you longer use out of a 20lb LP tank than will cooking on high every single time.

Furthermore, the way to ignite the burners is through the valves, so please understand the importance of this piece and the position/care taken to the knobs.

- Example: If you forget to turn a knob off and the burner is not lit, then you will have a gas leak out of that valve. You must be aware of your grills status and be responsible!

## **Burner Configuration and Heat Dispersion:**

If you look under the very front of your cooking grates, you will realize that for the first few inches, the burner does not release any gas. This is designed to be the medium heat portion of your grill for several reasons.

- One being that the flavorizers ensure even heat dispersion laterally across your grills cooking surface, so the front is designed to be your medium heat section, while you can utilize the middle of your cooking grates to get a good high heat (do not forget that this all depends on how high you have your valves turned as well).
- As you move towards the back of your grill and past the middle section, you will realize that this is the hottest portion of your grill.
  - Underneath, where the burner is bolted to the back of the body, you will see that there is a “crossover” in between each burner. This crossover, sends gas from one burner to the next (as long as the valves are open), to ensure that all of your burners will light in case your igniters fail.
  - For example, if you can only get one burner to light, you just need to keep the hood open and turn on the valve next to it, to the high position. Gas will then travel through the new/open burner and will catch the flame from the initial burner. This crossover does provide you constant heat across the back that increases the temperature and provides you with your hottest position on the grill (unless you have a CS model with a sear burner – in which the sear burner will provide your highest temperature for cooking/searing).

To understand how this will effect your cooking, please take a look at the pictures below for visual assistance.

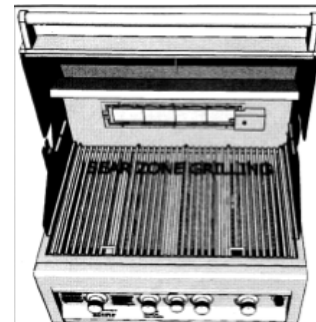



## **Burner Use – Indirect, Direct, Sear, Rotisserie Cooking**

As you can imagine, by controlling how much gas flows through your burner; determines the size of your flame. The ideal flame will be blue, with no yellow tip, or excessive noise coming out of the burner.

If you happen to have any of these problems:

- You will want to check the air adjustment screw on the side of the burner itself (called the Air Venturi) and also the adjustment screw that resides directly below the orifice to ensure proper gas flow into the burner from the valve
- There are many reasons that can cause poor flames and heat but none are more serious than a gas leak, so always pay attention for the odor of gas (NG or LP) but do not also forget to clean your burners!

For **Direct Cooking** you simply cook your food over a direct flame that is hot and quick to cook but is also the quickest way to burn your food. Pay attention closely if you choose this method!

**Indirect Cooking** however is used for larger cuts of meats and anything that you are intending to keep nice and juicy!

- All you need to do is turn off the burner that lies under the food being cooked and adjust the exterior burners flame so that you create a slow, constant and even cooking environment for your food!



If you are looking for a cooking experience that will almost instantly cook your food item, then **Sear Cooking** is an essential! Sear Cooking uses a ceramic burner that emits a different form of heat that can produce a much higher temperature quicker, to lock in the juices!

Now, if you are looking for an experience that will allow you to have a juicy bird, straight from the rotisserie of your grill, then **Rotisserie Cooking** is going to be your choice! Coyote grills utilize the same ceramic burner technology in their sear burner, as their rotisserie burner, along with a motor and spit that will hold and rotate up to 20lbs of food. Allowing you to cook a bird amazingly quick, without burning or charring any portion of it.

## **Instruction for Rotisserie Assembly**

**WARNING:** Never stand with your head directly over the Grill when preparing to light the Rotisserie burner, to prevent possible bodily injury.

Rotisserie is mostly used to cook large pieces of meat and poultry to assure slow, even cooking. The constant turning provides a self-basting action, making food cooked on a rotisserie exceptionally moist and juicy. Rotisserie cooking generally requires 1 ½ to 4½ hrs to cook depending on the size and type of meat being cooked. You can have rotisserie cooking with indirect heat with infrared rotisserie burner. Preferred by professional chefs over other methods, the intense heat is ideal for searing in the natural juices and nutrients found in quality meats.

For successful rotisserie, the meat should be centered and balanced as evenly as possible on the spit rod to avoid overworking the rotisserie motor.

1. Attach Motor Bracket Assembly to the side of the barbecue frame (can be mounted on either left or the right side of the frame) using two screws and two nuts.
2. Insert Rotisserie Motor onto Motor Bracket Assembly.
3. Assemble Key Washer, Counter-balance and handle to Spit Rod. Slide Shaft Collar with long end towards handle.
4. Slide Prong Forks with the prongs facing away from the handle onto the Spit Rod. Place food on to Spit Rod and secure with the second Prong Forks. Secure with thumbscrews. Place Spit Rod assembly and position into Motor. Secure position with thumbscrew. It may be necessary to secure any loose portions with butcher's string. Never use nylon or plastic string as it will melt and ruin the food.
5. Once the food is secured, place the sharp end of the Spit Rod onto the motor, and then rest the Spit Rod on the supports at either side of the grill.
6. Ensure that all Bolts are tightened securely.
7. When the rotisserie is being operated exclusively, it is strongly recommended that a pan be placed on the grilling grids, beneath the food to catch the meat drippings. This will prevent excessive build up of drippings on the grids and facilitate cleaning.
  - a) If your food is large and a pan will not fit on top of the grates, you can remove the cooking grates and place your pan directly on the flavorizers.
    - i. The center of your spit rod to the top of the hood, equals the same distance from the spit rod to the top of the flavorizers.

**NOTE:** Close hood carefully and align Motor Bracket and Shaft Mounting Bracket so that Rotisserie Rod is in between the hood openings.

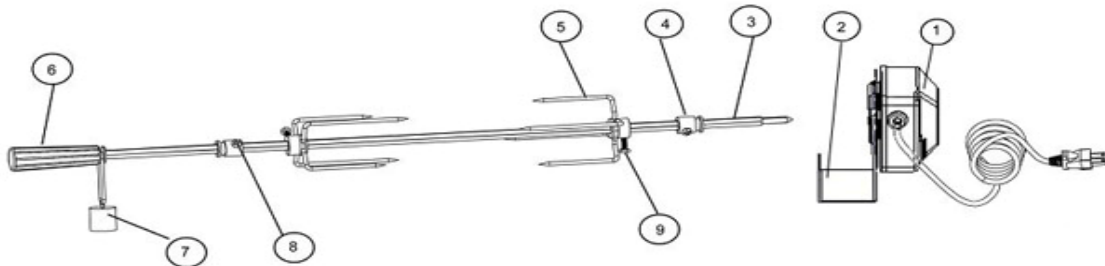

No.	Qty	Description
1	1	110V Motor
No.	Qty	Description
1	1	110V Motor
2	1	Motor Bracket
3	1	Spit Rod
4	2	Shaft Collar
5	2	4-Prong Fork
6	1	Handle
7	1	Counterbalance
8	2	Screw
9	2	Hexagonal Head Screw

**WARNING:** Never operate Rotisserie Burner with main (other) burner(s) "ON". Warming Rack must be removed when Rotisserie Burner is ON.

### **Electrical Grounding Instructions:**

- The rotisserie motor is equipped with a three-prong grounding plug for your protection against electric shock. This plug must be inserted directly into a properly grounded three-prong receptacle. Do not cut or remove the grounding prong from this plug.
- The rotisserie motor must be electrically grounded in accordance with local codes or, in the absence of local codes, in accordance with the *National Electrical Code, ANSI/NFPA 70-1990* or *Canadian Electrical Code, CSA C22.1*.
- Do not use an extension cord to supply power to your grill. Such use may result in fire, electrical shock or other personal injury. Do not install a fuse in the neutral or ground circuit. A fuse in the neutral or ground circuit may result in an electrical shock hazard. Do not ground this appliance to a gas supply pipe or hot water pipe.

### **Instruction for Connecting the Transformer**

1. **Transformer for Interior Lights** - Your transformer will connect on the left side of your grill (looking at it from the front) and operates the lights inside your grill. Follow the pictures and insert the white male plug into the white female socket, on the left side of your grill and then plug the transformer into a standard 110v outlet.



Left Side of Grills



Male Plug



Female Socket

2. **Transformer for Back Lit Knobs – (only on CSLX36 and CSLX42 models with back lit knobs)**





Your transformer will connect on the left side of your grill (looking at it from the front) and operates the LED lights behind knob bezels. Follow the pictures and connect the transformer, and then plug the transformer into a standard 110v outlet. Read below instruction for how to change new LEDs.



Remove the Knob

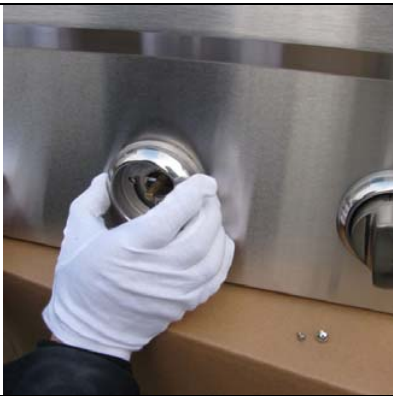

Remove the Screws

	
<p>Take Down the Knob Bezel</p>	<p>The LED Plastic Bezel</p>
	
<p>Pull Out the Wires</p>	<p>Disconnect the Wire and Change New LEDs</p>
<p>Do the opposite to assemble the LEDs.</p>	

**WARNING:** The transformer should be kept away from the heat of the BBQ.

# Lighting the Grill

## **DANGER**

- Failure to open the lid while igniting the barbecue's burners, or not waiting 5 minutes to allow the gas to clear if the barbecue does not light, may result in an explosive flame-up which can cause serious bodily injury or death.

## **WARNING**

- DO NOT use the grill if gas odor is present.
- DO NOT stand with head, body, or arms over the grill when lighting.
- Inspect the hose before using the grill. If there is excessive abrasion or wear, or if the hose is cut, it must be replaced prior to the outdoor cooking gas appliance being put into operation. The replacement hose assembly shall be that specified by the manufacturer.
- Ensure the area around the barbecue is clear of flammable substances such as gasoline, yard debris, wood, etc.
- Ensure there is no blockage of the airflow through the vent space located below the face of the unit.

## **GENERAL RULES**

### **Do not leave the grill unattended while cooking!**

- Make sure the grill has been leak tested and is properly located.
- Check the end of each burner tube is properly located over each valve orifice.
- Light the grill burners using the instructions provided in this manual.
- Adjust heat settings to your desired cooking temperature.
- Allow grill to cool down, wipe off any splatters or grease and clean the drip tray as needed.
- Do not put a cover on the grill while it is still hot as it could start a fire.

**NOTE:** If for some reason, igniters fail to light, burners can be lit with a gas lighter.

**NOTE:** Replace battery under ignition cap (twist off counter-clockwise)

**NOTE:** To light gas grill with a gas lighter, make sure the grill has been leak tested and burners be properly located. Remove the cooking grids and flavorizers from burner you wish to light. Insert long-necked gas lighter placing near to burner ports. Press in the last right control knob and rotate left to "HIGH" setting to release gas. Turn on the button on gas lighter, burner should light immediately. Place back the cooking grids and flavorizers. Adjust burners to desired cooking temperature.



**Keep any electrical supply cords and the fuel supply hose away from any heated surfaces.**

# Lighting Instructions for: CCX3 - CCX4 - CSX36 - CSLX36 - CSLX42

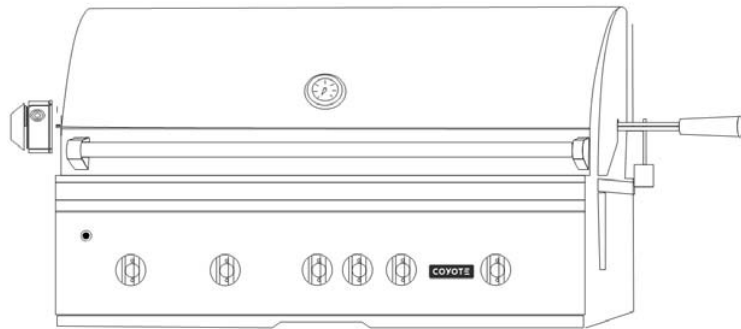

## Using the Ignition System:

1. Open the canopy
2. Keep your body, arms and face as far away from the burners and cooking surface as possible
3. Depress and rotate the knob counter clockwise to the "High" position.
  - a. As you are nearing the "High" position, you will notice the valve getting tougher to turn. This is the spring inside the valve building up energy to create the spark. Once you hear a click, the igniter has fired the spark and you must turn the valve completely off to generate another spark.
  - b. Do not turn the knob too fast, as you need the gas to travel into your manifold, then to your valve and finally into the burner where it will meet the spark from the igniter (at the front of the burner). Alternatively, if you turn it too slow, you can cause a build up of gas in the grill and create a large flash when it ignites.
4. If the burner does not catch on the first attempt, try again immediately but be very aware of any gas building up inside the grill. If the grill does light after three consecutive attempts, turn the valves to the "Off" position and allow the grill to clear of any built up gas for 5 minutes.
5. If at this point the grill will still not ignite, you can try the manual lighting process below with a long stem lighter and you can also contact Coyote Customer Service for further assistance to troubleshoot your grill.
6. To turn the grill "Off," you simply turn each knob clockwise until it can not turn anymore. It is also normal to experience a popping noise when the burners are turned off abruptly.

## Manually Lighting the Burners:

- If for some reason, igniters fail to light, burners can be lit with a gas lighter.
  - **To light gas grill with a gas lighter**, make sure the grill has been leak tested and burners can be properly located. Remove the cooking grids and flavorizers from the burner you wish to light. Insert long-necked gas lighter, placing it near the burner ports. Press in the far right control knob and rotate left to "HIGH" setting to release gas. Turn on the button on gas lighter, burner should light immediately. Place back the cooking grids and flavorizers. Adjust burners to desired cooking temperature.

# Operations and Features

When you first ignite your grill burn the grill to get rid of any odors or debris that may be left over from manufacturing and transit. This is done by operating your grill at the "HIGH" setting with the hood closed for no more than 5 minutes.

- Since this is a high temperature grill; closing the hood will cause heat to build up and could easily cause an excessive flare-up that could cause internal damage to the grill (knobs, igniter, etc.).
- After you have "burned off" the grill, you are ready for cooking!

## **Preparing Food for the Grill**

**WARNING:** Always observe safe food-handling and safe food-preparation practices when using this Grill, to prevent food-borne illnesses.

- Always cook foods adequately. Undercooked foods can retain bacteria, especially if thawed or exposed to warm conditions prior to cooking.
- Always use separate plates and utensils for the handling of raw food. Never place raw food and cooked food on the same plate, and never place cooked food on a plate that was used for handling raw food.
- Always carefully wash all plates and utensils used to handle raw food before using them to handle cooked food.
- Always wash all vegetables, seafood and poultry before cooking.
- Always leave uncooked foods in the refrigerator until you are ready to start cooking.
- Always marinate meat in the refrigerator. Dispose of the excess marinade, and never reuse it.

## **Grilling Tips:**

- If you pre-cook meat or poultry, do so immediately before grilling.
- Refrigerate leftovers within 2 hours of taking food off the grill.
- Never let the tray boil dry. That could be hazardous, as grease from fatty foods that have collected in the tray could ignite and possibly cause bodily injury or property damage.
- Use a meat thermometer to be sure food has reached a safe internal temperature.
- Always trim excess fat from your foods to reduce the occurrence of flare-ups during cooking.
- Apply a light coating of cooking oil to the cooking grids before grilling, to prevent foods from sticking.
- Cook similar portion sizes together, so that they all cook evenly.
- Use tongs to turn foods on the grill.
- Never pierce foods while they are cooking on the Grill, as this will dry them out.
- Turn foods infrequently. Some chefs say that a good steak should never be turned more than once.
- Apply sugar-based sauces such as commercial barbecue sauces only during the latter stages of cooking, to prevent charring.
- Soak the string you use to tie up roasts and poultry on the rotisserie spit to protect it from burning.
- Use a disposable aluminum tray filled with water, fruit juice, wine or a marinade to add extra flavor and moisture to slow-cooked foods like roasts, whole chickens, turkeys or ducks.

## **Controlling Flare-ups**

Flare-ups are a part of cooking meats on a gas grill. This adds to the unique flavor of cooking on a gas grill. Excessive flare-ups resulting from the build-up of grease in the bottom of the grill can over-cook the food and cause a dangerous situation for you and your grill. If this should occur, DO NOT pour water onto the flames, which can cause the grease to splatter and could result in serious burns or bodily harm. If grease fire occurs, close the hood and turn off the main burners until the grease burns out. Use caution when opening the hood as sudden flare-ups may occur.

## **To Minimize Flare-ups:**

- Trim excess fat from meats prior to cooking.
- Cook meats with high fat contents (chicken or pork) on Low settings or indirectly.
- Ensure that your grill is on level ground and the grease is allowed to evacuate the grill through the drain hole.

# Care & Maintenance

**CAUTION:** All cleaning and maintenance should be done only when grill is cool & with the fuel supply turned off at the cylinder. If your grill is set up for use with Natural Gas, turn off gas supply at the system manual shut off valve.

## **DRIP TRAY**

The drip tray located below the grill should be cleaned periodically to prevent heavy buildup of debris.

**NOTE:** Allow the drip tray to cool before attempting to clean.

**IMPORTANT:** Do not leave the grill outside during inclement weather unless it is covered (cover sold separately). Rain water can collect inside the grill, the grill cart or the drip tray if left uncovered. If the drip tray is not cleaned after use and the grill is left uncovered, the drip tray will fill with water causing grease and water to spill into the grill cart. We recommend cleaning and storing the drip tray after every use.

## **COOKING GRATES**

The cooking grates can be cleaned immediately after cooking is completed and after turning off the grill. Wear a barbecue mitt and scrub the cooking grates with a damp cloth. If the grill is allowed to cool down, cleaning the grates will be easier if removed from the grill and cleaned with a mild detergent.

## **FLAVORIZERS**

Washing the flavorizers after every use is not necessary but periodically it is suggested you wash them in a soap and warm water solution. Use a wire brush to remove stubborn burned on cooking residue. Dry the flavorizers & flame dividers thoroughly before you reinstall them in the cooking insert.

## **BURNERS**

**IMPORTANT:** Gas control knobs should be in the "OFF" position and fuel line should be disconnected. To reduce the chance of FLASHBACK, the procedure below should be followed at least once a month or when your grill has not been used for an extended period of time.

### **Main Burners:**

1. Remove your main burners from the grill by removing the nut holding the burner down in the back and carefully lifting each burner up and away from the gas valve orifice.
2. Wire brush entire outer surface of burner to remove food debris and dirt. Clean any clogged ports with a stiff wire such as an open paper clip.
3. Inspect the burner for damage (cracks or holes) and if such damage is found, order and install a new burner.
4. After installation, check to insure that gas valve orifices are correctly placed inside ends of burner tubes. Also check position of spark electrode.

**Sear Burners:** Sear burners are made out of ceramic and emit gas in a honeycomb pattern that is almost impossible to see. However, these burners get exceptionally hot and can be exceptionally easy to damage.

The way to clean these burners is:

1. Remove all large pieces of food from the top of the burner



2. Turn the burner on high and let the temperature do the work
3. Do not leave the grill unattended while doing this as you will want to make sure no excessive flare ups occur
4. Once all excess grease has been burned off, you are ready to go!
  - a. An easy way to keep your sear burner from getting dirty is to allow it to run for a few minutes after you are done cooking, so that you do not have to re-heat your grill just to clean.

## **Stainless Steel Care and Maintenance**

It is a common misconception that stainless steel will maintain its original factory shine with little help from the consumer. Unfortunately, this is not true. Stainless steel will not stain, discolor, corrode or rust as fast as other types of steel, but it is not fully stain or weather proof. If it is not properly maintained, all grades of stainless steel can face surface discoloration, corrosion and eventually rust. Any stainless steel that is exposed to the environment will require attention and care throughout its life to ensure that it keeps its shine and structural integrity.

### **Cleaning the Stainless Steel and Polishing**

1. To clean the stainless steel you will want to wash off all dirt and debris from the steel with warm water. If you have tough spots to clean, then a degreaser such as Formula 409 can be used.
2. Next, you will want to rinse and dry the steel thoroughly with a clean towel. Do not allow the steel to air dry as the standing water can cause surface discoloration.
3. The last thing you want to do is to protect to the unit with a good polish. There are several polishes on the market that work great (Barkeepers Friend Polish and Stainless Steel Magic are a few) and will help keep your grill protected from the elements for a longer period of time. Most of these polishes are toxic, so you would only want to use these on the exterior of the grill (not your cooking grates or flavorizers).
  - a. You will want to apply the polish to a clean paper towel and wipe with the direction of the grain in the stainless steel.
  - b. There should be no excess liquid on the surface but it is acceptable for it to be a little oily, as that will dissipate.
4. If you have a situation where your grill has developed surface discoloration or surface rust, then you need to clean the unit as stated above and use a good polish (Barkeepers Friend Polish, or Instant Rust Out) to remove the spots.
  - a. Each of these polishing agents take about 30 seconds to work and then you simply wipe off the product (if needed use a soft Scotch-Brite pad to remove any tough spots.) If you used Barkeepers Friend, then you do not need to do anything further. If you used Instant Rust Out (or another cleaning agent), you would want to wipe it down with fresh water and dry it off again with a clean towel and then coat the steel with a layer of WD-40 or another Stainless Polishing solution, which will act as a surface protectant for the steel.
    - i. **IMPORTANT:** Be sure not to have your grill on when using any flammable product, such as WD-40. These products are extremely flammable in their aerosol form.

### **Environmental Factors that can affect your Grill**

Mother Nature is a wonderful thing but unfortunately she can be tough on outdoor appliances. There are several usual causes for surface discoloration and corrosion on your stainless steel outdoor equipment:

- 1) Mortar (which contains lime) from the island assembly process, has rested on the unit for a pro-longed period of time and the unit was not cleaned quickly

- 2) Pool chemicals were splashed onto the grill (chlorine and acid will cause very quick problems) and the unit was not cleaned off quickly
- 3) Hard water from sprinklers (chlorine in the water) was allowed to sit on the unit
- 4) Salt from the ocean air/water was allowed to rest upon the grill for a prolonged period of time before being cleaned (beach owners must be diligent in maintaining their outdoor stainless equipment)
- 5) Dust, or rust, from other metals found its way onto the grill and was left on for an extended period of time.
- 6) Organic matters (such as certain types of food) might have gotten onto the surface of the grill and it was then covered. With high humidity and low oxygen, corrosion will start to take place.
- 7) Sprays and cleaning solutions containing alkaline, lime, acid, salt might have been left on the grill surface un-dried.
- 8) No stainless steel polish was ever used after one of the above mentioned acts took place.

#### **Ways to Avoid Rust on your Grill:**

- 1) Always purchase a Coyote Grill cover for your unit. This will ensure that your cover is correct fit and breathable, while providing the protection needed to keep all other contaminants off of the surface.
- 2) When installing the unit, make sure to keep the unit covered when any masonry work is being performed. If any mortar or dust does come into contact with the stainless, make sure to wipe it off as soon as possible and use a stainless steel polish immediately afterwards.
- 3) Position your grill away from areas that can receive water splash from a pool or hot tub.
- 4) Do not store pool chemicals in your island or island cabinets.

#### **How to Remove Scratches from your Stainless Steel:**

If your situation is a little more serious and you have obtained scratches in your equipment, then you will need to purchase a "stainless steel scratch kit." These kits are popular in retail stores but can be easier to obtain online. A very popular one is called "Scratch-B-Gone." With these kits, you will not polish the unit until you are done re-scratching the entire product you are working on. With a scratch kit, the goal is to literally re-scratch the entire surface, so that the original grains are replaced by your new scratched-in grains. With this practice, you must be willing to do the entire surface as you will notice a start and stop point. Also, be careful to pay attention to your rolled or finished edges as these scratch kits will ruin this finish. After you have used the kit, you will want to follow it up with a good stainless polish (as mentioned prior) and then a dry towel for a final wipe down.

#### **HOW TO CHANGE THE LIGHT BULBS**

1. Remove the screw holding the bulb lens.
2. Reach in using your fingers only, grip the two outside edges of the light bulb, do not grip the top or bottom of the bulb, as it might break. Pull the bulb straight out, so that the two electrode wires are completely removed with bulb. Place bulb in trash.
3. When installing the new halogen bulb be sure to use a clean cloth or paper towel to ensure the longevity of the bulb.
4. Insert the new bulb using your clean cloth and gently snap it into position. Wipe off any fingerprints and/or grease that may have transferred to the bulb.
5. Re-install the bulb lens and cover
6. Flip the switch on to check lights.

## **ANNUAL CLEANING OF GRILL HOUSING**

Burn-off the barbecue after every cookout will keep it ready for instant use, however, once a year you should give the entire grill a thorough cleaning to keep it in top operating condition.

1. Shut off gas supply at source and disconnects fuel line. Protect fuel line fitting.
2. Remove and clean the cooking grids, flavorizers and burners.
3. Remove warming rack and wash with mild detergent and warm water.
4. Cover the gas valve orifices with a piece of aluminum foil.
5. Brush the inside and bottom of the grill with a stiff wire brush, and wash down with a mild soap and warm water solution. Wash thoroughly and let dry.
6. Remove aluminum foil from orifices and check orifices for obstruction.
7. Check electrode.
8. Reinstall flavorizers, cooking grids, and warming rack.
9. Reconnect to gas source and observe burner flame for correct operation.

**IMPORTANT:** You should NOT line the bottom of the grill housing with aluminum foil, sand or any other grease absorbent substance. Grease will not be able to drip into the drip tray and a grease fire may occur.

## **MAINTENANCE GUIDELINES**

1. Keep outdoor cooking gas appliance area clear and free from combustible materials, gasoline and other flammable vapors and liquids.
2. Do not obstruct the flow of combustion and ventilation air.
3. Keep the ventilation opening(s) of the cylinder enclosure free and clear from debris.
4. Visually check burner flames. Burner flames should be blue and stable with no yellow tips, excessive noise, or lifting. If any of these conditions exist call our customer service line.
5. Clean outdoor cooking gas appliance, including special surfaces, with recommended cleaning agents, if necessary.
6. Check and clean burner for insects and insect nests. A clogged tube can lead to a fire beneath the grill.

## **Recommended Cleaners for Specific Situations**

<b>JOB</b>	<b>CLEANING AGENTS</b>	<b>COMMENTS</b>
Routine Cleaning	Soap, ammonia, detergent Medallion	Apply with cloth or sponge
Fingerprints & smears	Arcal 20, Lac-O-Nu Ecoshine	Provides barrier film
Stubborn stains & discoloration	Cameo, Talc, Zud First Impression	Rub in direction of polish lines
Grease & Oil	Any good commercial detergent	Apply with sponge or cloth
Restoration/ Passivation	Benefit, Super Sheen	

# Troubleshooting Your Grill

## GENERAL TROUBLE SHOOTING

You should inspect the burners at least once a year or immediately if any of the following conditions occur:

- The smell of gas.
- Flames appearing mostly yellow. (Some yellow at the tips is OK)
- The grill will not get hot enough.
- Burners make a snapping noise.
- The grill heats unevenly.

## SPIDER AND INSECT WARNING

**INSECT WARNING:** Spiders and insects can nest in the burners of this and other grills, which could disrupt gas flow. This dangerous condition could cause a fire behind and beneath the valve panel, damaging the grill and making it unsafe to operate. We recommend you check the grill and remove any spiders, insects and webs at least once a year to reduce this risk.

## WHEN TO LOOK FOR SPIDERS

You should inspect the burners once a year or immediately after any of the following conditions occur:

1. The smell of gas in conjunction with the burner flames appearing yellow.
2. The grill does not reach temperature.
3. The grill heats unevenly.
4. The burners make popping noises.

## BEFORE CALLING FOR SERVICE

If the grill does not function properly, use the chart below before contacting your dealer for service. You may save yourself the cost of a service call. Troubleshooting is for general purposes only. If the problem still exists, contact your dealer or the nearest authorized agency for service.

<b>Problem:</b>	<b>Possible Causes and Solutions:</b>
<b>Grill will not light when the igniter button is pushed.</b>	<ul style="list-style-type: none"><li>• Is your gas supply turned on?</li><li>• If this is an L.P. grill, is there gas in your tank? Check your gas level.</li><li>• Is one of your burners turned on? Allow up to 5 seconds of gas flow to ignite.</li><li>• Is your igniter working?<ul style="list-style-type: none"><li>- You should hear a snapping sound when you press the igniter.</li><li>- If you hear a snapping sound, can you see a spark at the electrodes?</li></ul></li></ul> <p><b>Note: You will need to remove your cooking grates and flavorizers to see the electrodes. The electrodes should have a 1/8" to 1/4" gap between the electrode and contact point.</b></p>

	<ul style="list-style-type: none"> <li>• Check your igniter battery and replace if needed.</li> <li>• Check for loose wire connections to the igniter or electrodes.</li> <li>• Check to see if debris is blocking the electrodes.</li> <li>• If the igniter is not working, can you light the grill with a lighter?</li> </ul>
<b>Flare-ups</b>	<ul style="list-style-type: none"> <li>• Check flavorizers and cooking grates for excess food or grease build-up.</li> <li>• Ensure grill is not placed directly in the path of wind.</li> </ul> <p>Be sure drip tray is clean (do not use aluminum foil on drip tray.)</p> <p><b>Note: Some flare-ups may be inevitable if cooking greasy foods.</b></p>
<b>Yellow Flames</b>	<ul style="list-style-type: none"> <li>• Check the burner inlet for obstructions, particularly at air inlets for each burner.</li> <li>• Grill may be in an area that is too windy.</li> </ul>
<b>Flame blows out on low setting or has uneven heat distribution.</b>	<ul style="list-style-type: none"> <li>• Check for spider webs or insect nest in venturi and clean venturi.</li> <li>• Cold grill needs to be preheated for 5 minutes on high setting.</li> <li>• Venturi may be misaligned and needs to be lined up over orifices.</li> <li>• Cold and windy weather will require you to move grill away from the wind.</li> <li>• Lack of fuel. Check to see cylinder valve is open and cylinder has fuel.</li> </ul>
<b>Low heat with the knob on "HIGH"</b>	<ul style="list-style-type: none"> <li>• Check to see if the fuel hose is bent or kinked.</li> <li>• Make sure the grill area is clear of dust.</li> <li>• Check your gas supply and gas pressure.</li> <li>• If it is only one burner that appears low, make sure the orifice or burner is clean.</li> </ul>
<b>Grill is Too Hot</b>	<ul style="list-style-type: none"> <li>• Excess grease build-up causing grease fires.</li> <li>• Damaged or faulty regulator. Replace with factory authorized parts.</li> <li>• Cook on a lower temperature setting.</li> </ul>
<b>Flame behind control panel or control knob area.</b>	<p><b>IMMEDIATELY shut off cylinder valve and allow grill to cool.</b></p> <ul style="list-style-type: none"> <li>• Check for spider webs or insect nest in venturi and clean venturi.</li> <li>• Gas is leaking from a faulty connection. Tighten connections with an adjustable wrench and replace damaged parts. Perform a leak test on all connections before cooking on grill again.</li> <li>• Venturi may be misaligned and needs to be lined up over orifice.</li> </ul>
<b>Fire at any connection.</b>	<p><b>IMMEDIATELY shut off cylinder valve and allow grill to cool.</b></p> <ul style="list-style-type: none"> <li>• Gas is leaking from a faulty connection. Tighten connections with an adjustable wrench and replace damaged parts.</li> <li>• Perform a leak test on all connections before cooking on grill again.</li> </ul>

# Limited Warranty

Coyote Outdoor warrants to the original purchaser at the original site of delivery with proof of purchase of each Outdoor Gas grill/Side burner that when subject to normal residential use, it is free from defects in workmanship and materials for the periods specified below. This warranty excludes grills used in rental and commercial applications. This warranty excludes surface corrosion, scratches, and discoloration which may occur during regular use. It **does NOT** cover labor or labor related charges. There will be shipping and handling charge for the delivery of the warranty part(s).

<u>COMPONENT</u>	<u>WARRANTY PERIOD</u>
Cooking Grids (no rust or burn through) .....	5 years (limited)
Flavorizer Bars (no rust or burn through).....	2 years (limited)
Electric/Plastic Components .....	2 years (limited)
Ignition systems/Valves .....	1 year (limited)
Stainless steel frame/housing .....	Limited Lifetime
Stainless Steel Burners (no rust or burn through) .....	Limited Lifetime

Our obligation under this warranty is limited to repair or replacement, at our option, of the product during the warranty period. The extent of any liability of Coyote under this warranty is limited to repair or replacement. This warranty does not cover normal wear of parts, damage resulting from any of the following: negligent use or misuse of the product, use on improper fuel/gas supply, use contrary to operating instructions, or alteration by any person other than a factory service center. The warranty period is not extended by such repair or replacement.

**WARRANTY CLAIM PROCEDURE:** If you require service or parts for your Coyote Grill, please contact our Warranty Service Center for factory direct assistance. Our hours of operation are 8 am to 4 pm CST. The phone number is 855.520.1559 and the Fax number is 214.520.1450. You may also fill out warranty claims online at [www.coyoteoutdoor.com](http://www.coyoteoutdoor.com). **Please have your model number, serial number and proof of purchase available for any warranty claim.**

Coyote Outdoor may require the return of defective parts for examination before issuing replacement parts. If you are required to return defective parts, shipping charges must be prepaid by the customer. Upon examination and to Coyote Outdoor's determination, if the original part is proven defective, Coyote Outdoor, may approve your claim and elect to replace such parts without charge. In any instance, customer is responsible for shipping and handling of the replacement parts. Product repair as provided under this warranty is your exclusive remedy. Coyote Outdoor shall not be liable for any incidental or consequential damages for breach of any express or implied warranty on its products.

This warranty does not cover any failures or operating difficulties due to accidents, abuse, misuse, alteration, misapplication, vandalism, improper installation, maintenance or service, damages caused by flashback fire or grease fires, as set out in the Owner's Manual. This warranty does not cover scratches, dents, corrosion or discoloration caused by weather, heat, abrasive and chemical cleaners, pool or spa chemicals, and/or any tools used in the assembly or installation of this unit. This warranty does not cover paint loss, surface rust, corrosion or stainless steel discoloration which is considered normal wear and tear.

This warranty does not cover the cost of any inconvenience, personal injury, or property damage due to improper use or product failure. Deterioration or damage due to severe weather conditions such as hail, hurricanes, earthquakes, tsunamis, tornadoes, terrorism, discoloration due to exposure to chemicals either directly or in the atmosphere, Acts of God/forces of Nature are not covered by this limited warranty.

### CCX3 Exploded Parts View

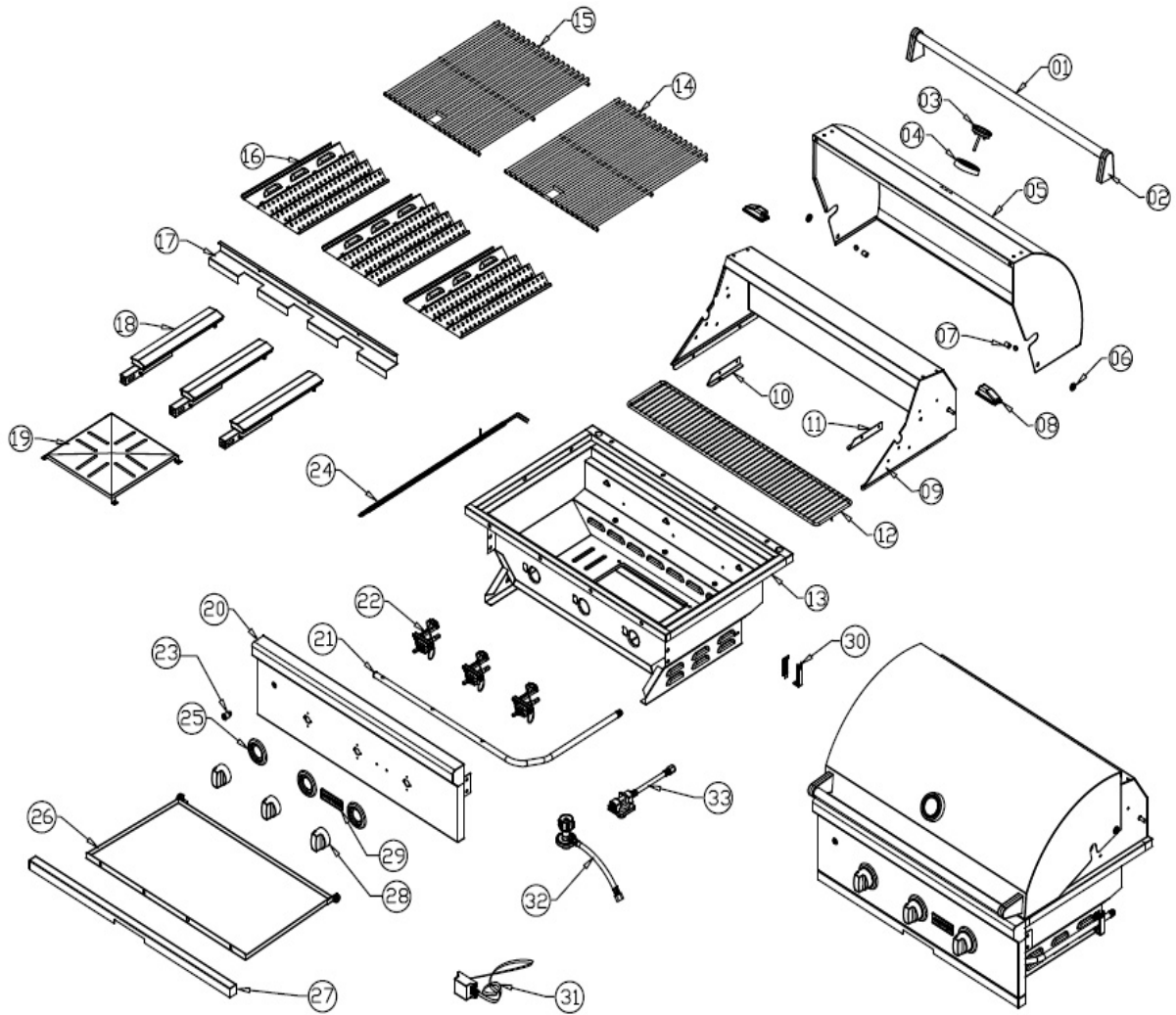



CCX3 Parts Listing				
No.	Name	Qty	Part No.	
1	Hood Handle-3B	1	C3B00006	
2	Handle Fixing	2	C0000007	
3	Thermometer	1	C0000022	
4	Thermometer Base	1	C0000044	
5	Hood -3B	1	C3B00005	
6	Rubber Stopper	2	C0000032	
7	Hood Connector Hardware	2	C0000045	
8	Light	2	C0000014	
9	Lower Hood-3B	1	C3B00007	
10	Warming Rack Bracket - Left	1	C0000025-1	
11	Warming Rack Bracket - Right	1	C0000025-2	
12	Warming Rack-3B	1	C3B00008	
13	Firebox-3B	1	C3B00003	
14	Grate (1pc) 18 Bar	1	CCG00018	
15	Grate (1pc) 19 Bar	1	CCG00019	
16	Flavorizer-3B	3	C3B00009	
17	Flavorizer Bracket-3B	1	C3B00004	
18	SUS Burner	3	C0000201	
19	Firebox Bottom Cover	1	C0000046	
20	Control Panel-3B	1	C3B00001	
21	Gas Pipe-3B	1	C3B00010	
22	Standard Valve LP	3	CX400012	
22	Standard Valve NG		CX400013	
23	Light Switch	1	C0000052	
24	3-Burner Light Wire	1	C3000001	
25	Knob Base	3	C0000012	
26	Drip Tray-3B	1	C3B00002	
27	Drip Tray Front Bar-3B	1	C3B00012	
28	Knob	3	C0000011	
29	Logo Badge	1	CH500019	
30	Gas Pipe Clamp	1	C0000044	
31	Transformer	1	C0000023	
32	LP Regulator	1	C0000030	
33	NG Regulator	1	C0000038	

## CCX4 Exploded Parts View

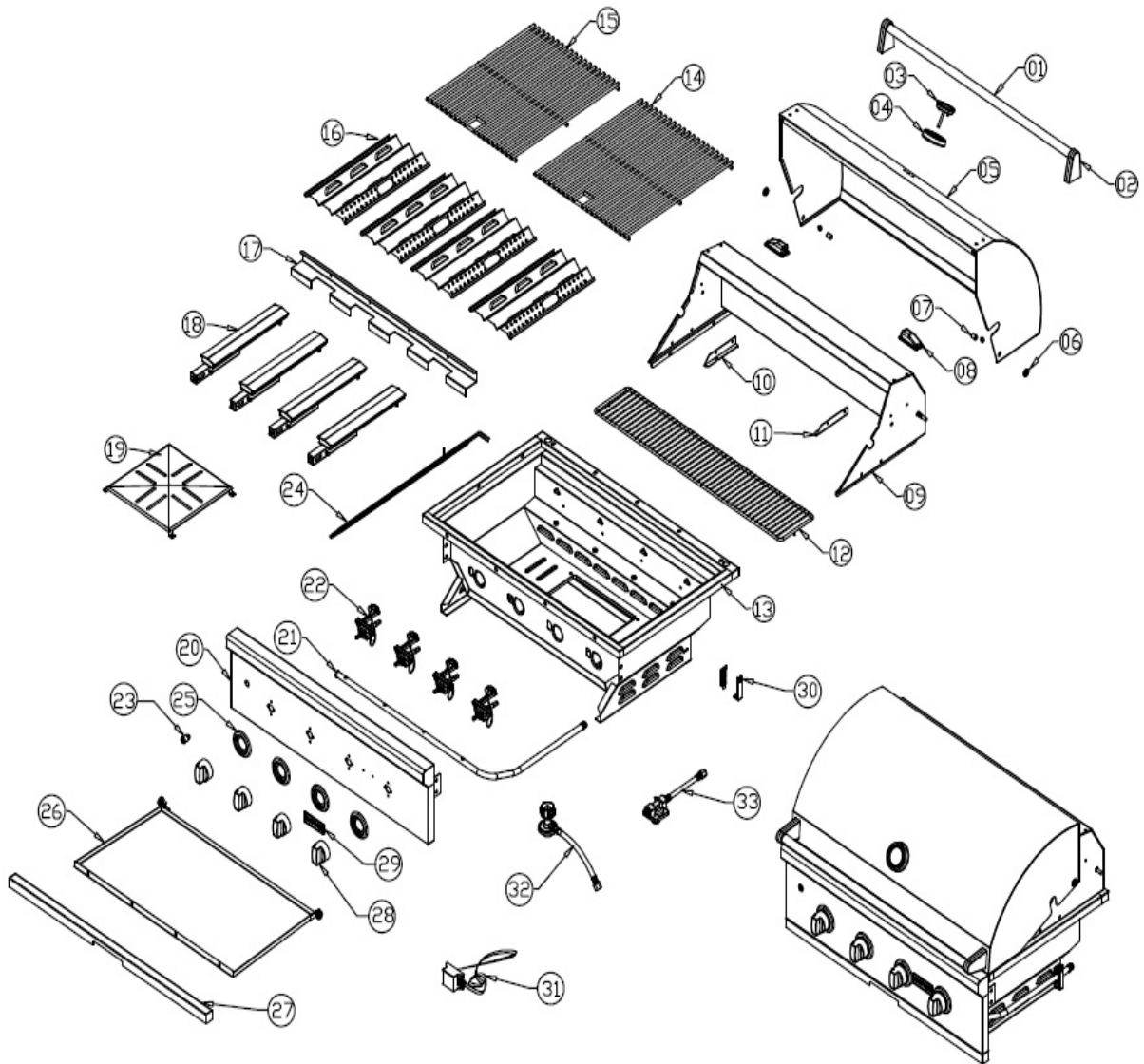

CCX4 Parts Listing				
No.	Name	Qty	Part No.	
1	Hood Handle-36	1	C3600006	
2	Handle Fixing	2	C0000007	
3	Thermometer	1	C0000022	
4	Thermometer Base	1	C0000044	
5	Hood -36	1	C3600005	
6	Rubber Stopper	2	C0000032	
7	Hood Connector Hardware	2	C0000045	
8	Light	2	C0000014	
9	Lower Hood-CCX4	1	CX400007	
10	Warming Rack Bracket - Left	1	C0000025-1	
11	Warming Rack Bracket - Right	1	C0000025-2	
12	Warming Rack-36	1	C3600008	
13	Firebox-CCX4	1	CX400003	
14	Grate (1pc) 19 Bar	1	CCG00019	
15	Grate (1pc) 20 Bar	1	CCG00020	
16	Flavorizer-CCX4	4	CX400009	
17	Flavorizer Bracket-CCX4	1	CX400004	
18	SUS Burner	4	C0000201	
19	Firebox Bottom Cover	1	C0000046	
20	Control Panel-CCX4	1	CX400001	
21	Gas Pipe-CCX4	1	CX400010	
22	Standard Valve LP	4	CX400012	
22	Standard Valve NG		CX400013	
23	Light Switch	1	C0000052	
24	4-Burner Light Wire	1	C4000001	
25	Knob Base	4	C0000012	
26	Drip Tray-CCX4	1	CX400002	
27	Drip Tray Front Bar-CCX4	1	CX400011	
28	Knob	4	C0000011	
29	Logo Badge	1	CH500019	
30	Gas Pipe Clamp	1	C0000044	
31	Transformer	1	C0000023	
32	LP Regulator	1	C0000030	
33	NG Regulator	1	C0000038	

## CSX36 & CSLX36 Exploded Parts View

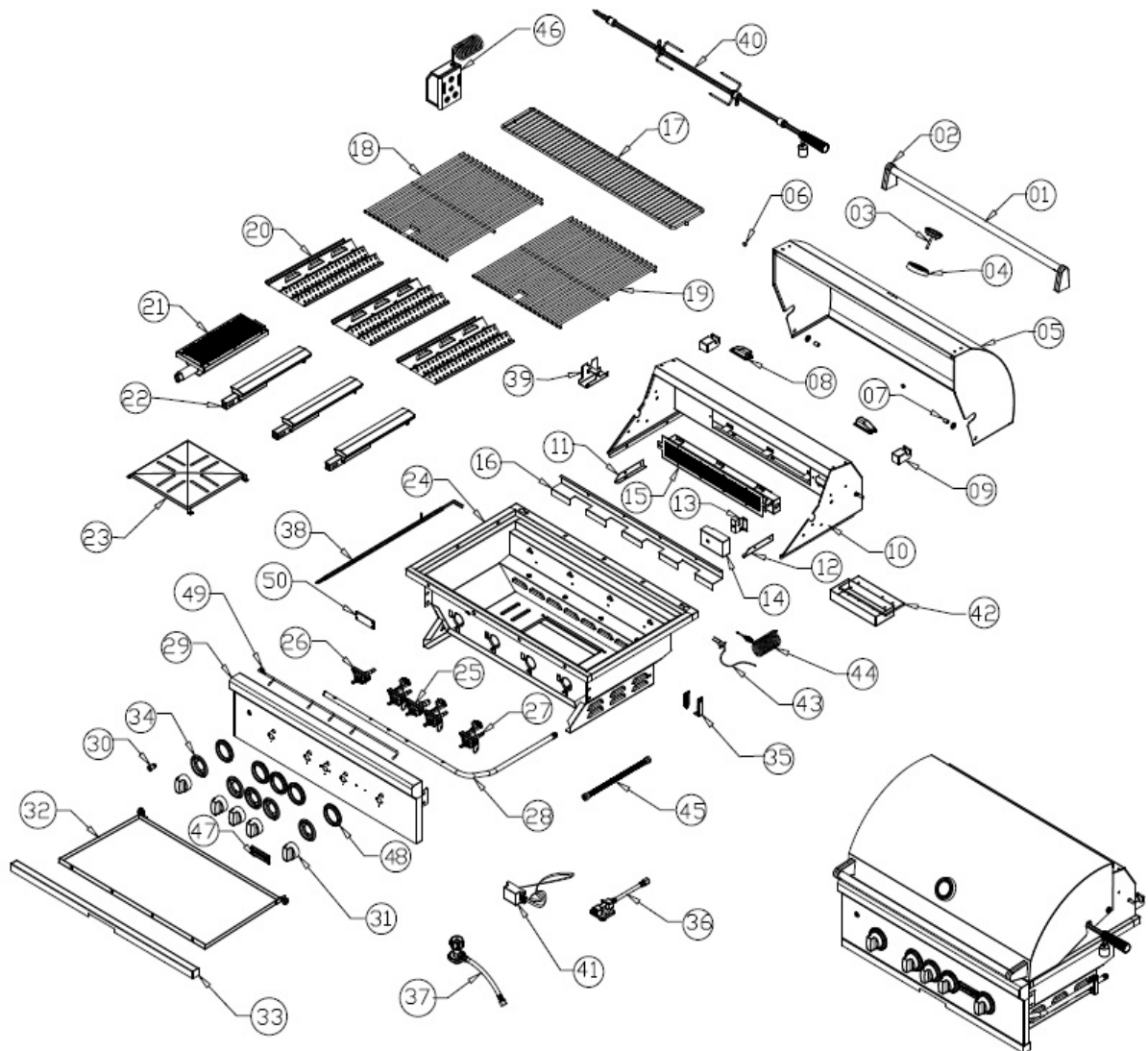

**CSX36 and CSLX36 Parts Listing**

No.	Name	Qty	Part No.
1	Hood Handle-36	1	C3600006
2	Handle Fixing	2	C0000007
3	Thermometer	1	C0000022
4	Thermometer Base	1	C0000044
5	Hood -36	1	C3600005
6	Rubber Stopper	2	C0000032
7	Hood Connector Hardware	2	C0000045
8	Light	2	C0000014
9	Rotisserie Rod Bracket	2	C0000018
10	Lower Hood-36	1	C3600007
11	Warming Rack Bracket - Left	1	C0000025-1

<b>CSX36 and CSLX36 Parts Listing</b>				
	12	Warming Rack Bracket - Right	1	C0000025-2
	13	IR Burner Lighting Bracket	1	C0000053
	14	IR Burner Lighting Box	1	C0000054
	15	IR Burner-36	1	C3600011
	16	Flavorizer Bracket-36	1	C3600004
	17	Warming Rack-36	1	C3600008
	18	Grate (1pc) 19 Bar	1	CCG00019
	19	Grate (1pc) 20 Bar	1	CCG00020
	20	Flavorizer-36	3	C3600009
	21	Sear Burner	1	C0000019
	22	SUS Burner	3	C0000201
	23	Firebox Bottom Cover	1	C0000048
	24	Firebox-36	1	C3600003
	25	Safety Valve (IR Burner) LP	1	CX500013
	25	Safety Valve (IR Burner) NG		CX500014
	26	Sear Burner Valve LP	1	CX400015
	26	Sear Burner Valve NG		CX400016
	27	Standard Valve LP	3	CX400012
	27	Standard Valve NG		CX400013
	28	Gas Pipe-36	1	C3600010
	29	Control Panel-36	1	C3600001
	30	Light Switch	1	C0000052
	31	Knob	5	C0000011
	32	Drip Tray-36	1	C3600002
	33	Drip Tray Front Bar-36	1	C3600012
	34	Knob Base	5	C0000012
	35	Gas Pipe Clamp	1	C0000044
	36	NG Regulator	1	C0000038
	37	LP Regulator	1	C0000030
	38	4-Burner Light Wire	1	C4000001
	39	Motor Bracket	1	C0000016
	40	Rotisserie Kit - 36	1	CROT0036
	41	Transformer for CSX36	1	C0000023
	41	Transformer for CSLX36	1	C0000055
	42	Smoker Box	1	C0000020
	43	IR Burner Lighting Electrode	1	C0000950
	44	Thermocouple-36	1	C3600018
	45	Stainless Steel Corrugated Hose	1	C0000031
	46	Motor	1	C0000015
	47	Logo Badge	1	CH500019
	48	LED Light Ring	5	C0000041
	49	LED Wiring Harness - 36	1	C0000042
	50	Transformer Circuit Board (CSLX only)	1	C0000056

### CSLX42 Exploded Parts View

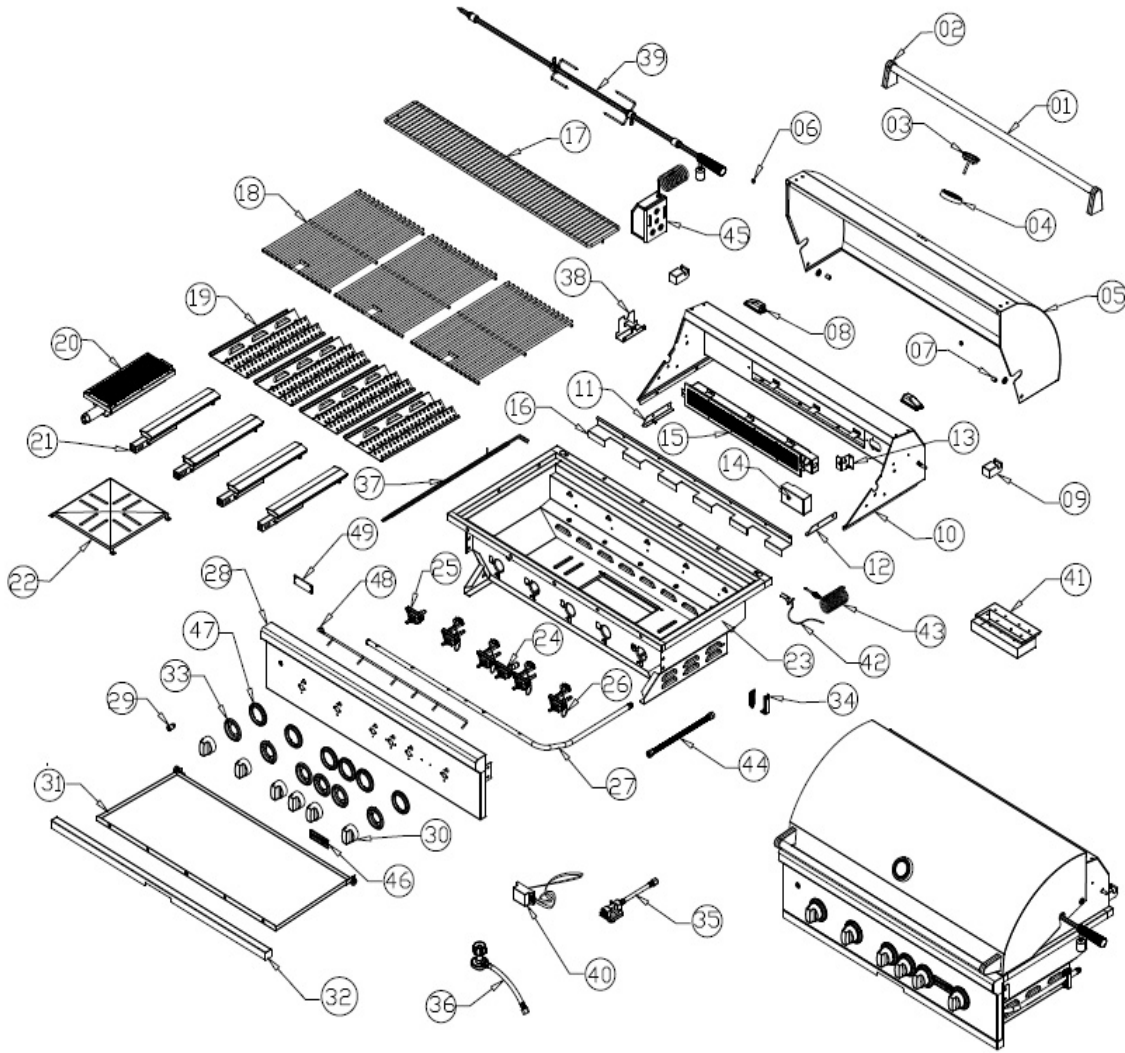

**CSLX42 Parts Listing**

No.	Name	Qty	Part No.
1	Hood Handle-42	1	C4200006
2	Handle Fixing	2	C0000007
3	Thermometer	1	C0000022
4	Thermometer Base	1	C0000044
5	Hood -42	1	C4200005
6	Rubber Stopper	2	C0000032
7	Hood Connector Hardware	2	C0000045
8	Light	2	C0000014
9	Rotisserie Rod Bracket	2	C0000018
10	Lower Hood-42	1	C4200007
11	Warming Rack Bracket - Left	1	C0000025-1
12	Warming Rack Bracket - Right	1	C0000025-2
13	IR Burner Lighting Bracket	1	C0000053

CSLX42 Parts Listing				
	14	IR Burner Lighting Box	1	C0000054
	15	IR Burner-42	1	C4200011
	16	Flavorizer Bracket-42	1	C4200004
	17	Warming Rack-42	1	C4200008
	18	Grate (1pc) 15 Bar	3	CCG00015
	19	Flavorizer-42	4	C4200009
	20	Sear Burner	1	C0000019
	21	SUS Burner	4	C0000201
	22	Firebox Bottom Cover	1	C0000048
	23	Firebox-42	1	C4200003
	24	Safety Valve (IR Burner) LP	1	CX500013
	24	Safety Valve (IR Burner) NG		CX500014
	25	Sear Burner Valve LP	1	CX500015
	25	Sear Burner Valve NG		CX500016
	26	Standard Valve LP	4	CX400012
	26	Standard Valve NG		CX400013
	27	Gas Pipe-42	1	C4200010
	28	Control Panel-42	1	C4200001
	29	Light Switch	1	C0000052
	30	Knob	6	C0000011
	31	Drip Tray-42	1	C4200002
	32	Drip Tray Front Bar-42	1	C4200012
	33	Knob Base	6	C0000012
	34	Gas Pipe Clamp	1	C0000044
	35	NG Regulator	1	C0000038
	36	LP Regulator	1	C0000030
	37	5-Burner Light Wire	1	C5000001
	38	Motor Bracket	1	C0000016
	39	Rotisserie Kit - 42	1	CROT0042
	40	Transformer	1	C0000055
	41	Smoker Box	1	C0000020
	42	IR Burner Lighting Electrode	1	C0000950
	43	Thermocouple-42	1	C4200018
	44	Stainless Steel Corrugated Hose	1	C0000031
	45	Motor	1	C0000015
	46	Logo Badge	1	CH500019
	47	LED Light Ring	6	C0000041
	48	LED Wiring Harness - 42	1	C0000043
	49	Transformer Circuit Board	1	C0000056