

JDH/C1 Series Equipped with halogen lighting. Not available with heat lamps.

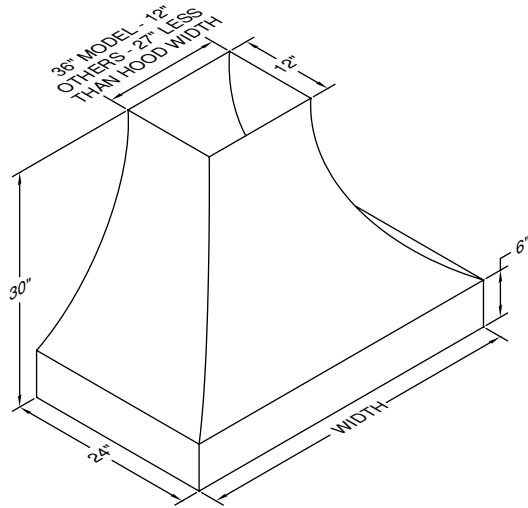

### Recommended Mounting Height

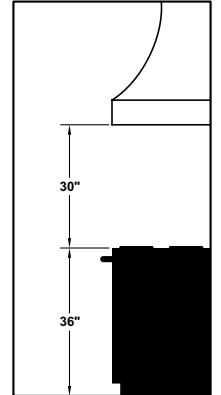

\*Recommended mounting height is for optimum performance.

### Connection Diagrams (36" - 48" Widths)

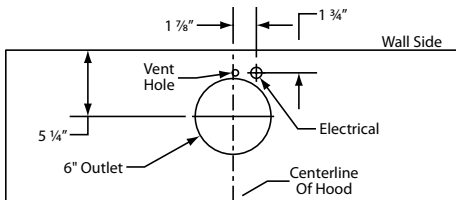

**B100 Single Blower (Top View)**

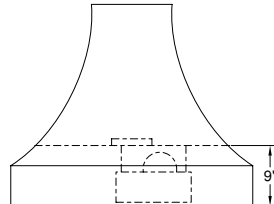

**(Front View)**

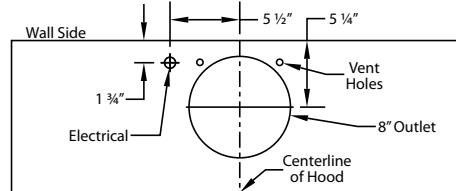

**B200 Dual Blower (Top View)**

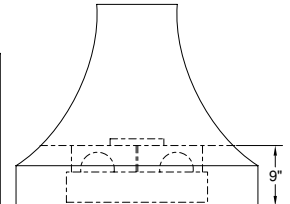

**(Front View)**

### Connection Diagram (48" - 60" Widths)

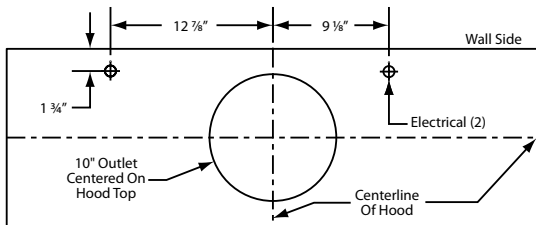

**900 CFM B200 Dual & B100 Single Blower (Top View)**

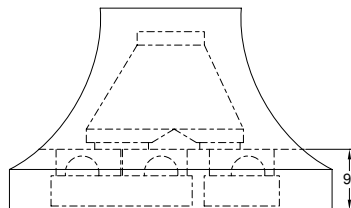

**VP562 Standard Transition Installed (Front View)**

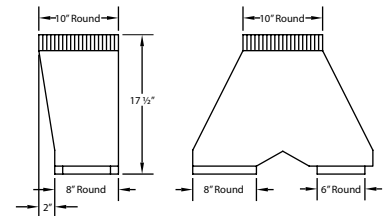

**VP562 Standard Transition Included**

### Connection Diagram (54" - 66" Widths)

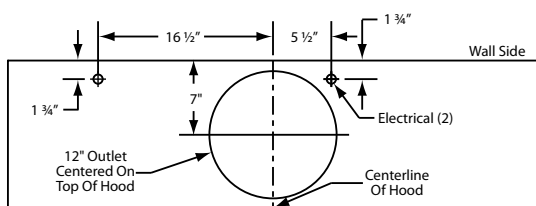

**1200 CFM Double B200 Dual Blowers (Top View)**

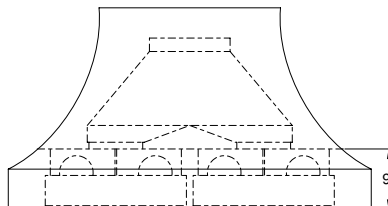

**VP563 Standard Transition Installed (Front View)**

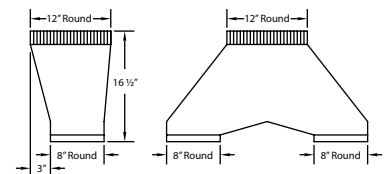

**VP563 Standard Transition Included**

### Electrical/Mechanical Specifications For Blower Units

| Model                   | Volts | Amps* | Hz | RPM  | CFM SP@0.0" | Equivalent CFM* | CFM SP@0.1" | CFM SP@0.2" | CFM SP@0.3" | Minimum Round Duct Size            | Sones# |
|-------------------------|-------|-------|----|------|-------------|-----------------|-------------|-------------|-------------|------------------------------------|--------|
| B100 Single             | 115   | 1.5   | 60 | 1550 | 300         | 450             | 273         | 245         | 225         | 6" (28 in. <sup>2</sup> )          | 5.4    |
| B200 Dual               | 115   | 2.9   | 60 | 1550 | 600         | 900             | 531         | 480         | 430         | 8" (50 in. <sup>2</sup> )          | 6.5    |
| B200 Dual & B100 Single | 115   | 4.4   | 60 | 1550 | 900         | 1350            | 804         | 725         | 655         | VP562: 10" (79 in. <sup>2</sup> )  | 6.3    |
| Two B200 Duals          | 115   | 5.8   | 60 | 1550 | 1200        | 1800            | 1062        | 960         | 860         | VP563: 12" (113 in. <sup>2</sup> ) | 6.6    |

\* Add 0.5 amp for each halogen light. Hoods are available with halogen lights (2 lights: 30" - 41", 3 lights: 42" - 53", 4 lights: 54" - 66").

# Because the Magic Lung® blower uses centrifugal filtration rather than conventional baffle or mesh filters, the Magic Lung® blower can handle cooking equipment with higher cubic feet per minute (CFM) requirements and can deliver equivalent CFM much more efficiently than other than other filtration systems. When comparing the Magic Lung® with other blower units made by other manufacturers, use the "Equivalent CFM".

# Ratings in accordance with the Standard Test Code by the Energy Systems Laboratory of the Texas Engineering Experiment Station.