

Dear Customer,

Thank you for choosing this quality product from ASKO.

We hope it will meet your expectations and fulfill your needs for many years to come. Scandinavian design combines clean lines, everyday functionality, and high quality. These are key characteristics of all our products and the reason they are greatly appreciated throughout the world.

To ensure that you get the most out of your new machine, we recommend that you read the operating instructions before using the machine. The operating instructions also contain information on how to avoid damaging the environment.



Operating Instructions

Washing Machine
ASKO W6324W

Contents

Before using your machine for the first time	4	Operating instructions	15
Transport protection	4	Sort your laundry.	15
Packing material	4	Turn on the main power switch	15
Washer door	4	Open the washer door and load the laundry	15
Checking water hardness	4	Add detergent and fabric softener, as required	15
Important safety instructions	5	Select the program	16
Grounding instructions	5	Select options	18
Installation	6	Close the washer door and press the Start/Stop button	18
Overflow guard function	6	Once the program has finished	19
Transport/Winter storage	6	You can change the following settings:	19
Disposal	6	Door opening	19
Child safety	7	Care and maintenance instructions	20
Keep an eye on children!	7	Cleaning the trap and the drain pump	20
Parts of the washing machine	8	Cleaning the detergent compartment	20
Detergent compartment	9	Cleaning the outside of the machine	20
Advice and tips before washing	10	Cleaning the inside of the machine to avoid unpleasant smells	20
Sorting your laundry	10	Rinse holes under the paddle	21
Clothing	10	If you have hard water	21
Laundry labels	10	Troubleshooting	22
Advice and tips before washing	11	The washer door will not open	22
Coloured cotton	12	The machine will not start	22
Unbleached linen	12	After power failure	22
Wool	12	Wet laundry still in the machine	22
Rayon fibers and synthetic fibers	12	Error messages	23
Reducing allergic reactions	12	Technical information	24
Economy and efficiency	12	Technical data	24
Detergents	12	Transport protection	25
Dyeing fabrics	12	Installation	26
Liquid detergents	13	Water supply connection	26
Detergents	13	Installation	28
Recommended powder detergents	13	Service	29
Detergent Amounts Based on Water Hardness	13	Before contacting the Customer Care Center	30
Amount of detergent to use	13	Quick guide	32

Before using your machine for the first time

Do you need this Use&Care Guide in Spanish? Log on to www.askona.com/customer-care to download.
¿Necesita esta Instrucciones de uso y cuidado en español? Entre en www.askona.com/customer-care y descárguela.

Before using your machine for the first time

Transport protection

Remove any transport protection devices before installing the machine. See the "Transport protection" chapter.

Packing material

Please sort waste materials in accordance with local guidelines.

Washer door

- The washer door cannot be opened until the machine is connected to the electricity supply.
- To open the door manually, see "The washer door will not open" in the "Troubleshooting" chapter.
- The machine cannot be started when the door is open.
- To open the washer door while a program is running, see "Close the door and press the Start/Stop button" in the "Operating instructions" chapter.

Checking water hardness

The quantity of detergent needed depends, among other things, on water hardness. See the detergent pack for details. Phone your local water company to check the water hardness in your area.

NOTE!

Each machine is tested before leaving the factory.

A small amount of water may remain in the drain pump, though this does not affect quality or damage the machine.

See Quick guide on the last page

Important safety instructions



SAVE THESE INSTRUCTIONS FOR FUTURE REFERENCE

WARNING!



To reduce the risk of fire, electric shock, or injury to persons when using your appliance, follow basic precautions, including the following:

- Read all instructions before using the appliance.
- Do not run appliance while you are out of the home.
- Do not wash or dry articles that have been previously cleaned in, washed in, soaked in, or spotted with gasoline, dry-cleaning solvents, cooking oils, or other flammable or explosive substances because they give off vapors that could ignite or explode.
- Do not allow children to play on or in the appliance. Close supervision of children is necessary when the appliance is used near children.
- Before the appliance is removed from service or discarded, remove the door to the washing compartment.
- Do not reach into the appliance if the drum is moving.
- Do not install or store this appliance where it will be exposed to the weather.
- Do not tamper with controls.
- Do not repair or replace any part of the appliance or attempt any servicing unless specifically recommended in the user-repair instructions or in published user-repair instructions that you understand and have the skills to carry out.
- Do not add gasoline, dry-cleaning solvents, or other flammable or explosive substances to the wash water. These substances give off vapors that could ignite or explode.
- Under certain conditions, hydrogen gas may be produced in a hot water system that has not been used for 2 weeks or more. **HYDROGEN GAS IS EXPLOSIVE.** If the hot water system has not been used for such a period, before using a washing machine or combination washer-dryer, turn on all water faucets and let

the water flow from each for several minutes. This will release any accumulated hydrogen gas. As the gas is flammable, do not smoke or use an open flame during this time.

WARNING!



This appliance must be properly grounded. This manual does not cover every possible condition and situation that may occur. Use common sense and caution when installing, operating, and maintaining any appliance.

Grounding instructions

A) Grounding instructions for a grounded, cord-connected appliance:

In the event of malfunction or breakdown, grounding will reduce the risk of electric shock by providing a path of least resistance for electric current. This appliance is equipped with a cord having an equipment-grounding conductor and a grounding plug. The plug must be plugged into an appropriate outlet that is properly installed and grounded in accordance with all local codes and ordinances.

WARNING!



Improper connection of the equipment-grounding conductor can result in a risk of electric shock. Check with a qualified electrician or service representative or personnel if you are in doubt as to whether the appliance is properly grounded. Do not modify the plug provided with the appliance. If it will not fit the outlet, have a proper outlet installed by a qualified electrician.

Important safety instructions



B) Grounding instructions for a permanently connected appliance:

This appliance must be connected to a grounded metal, permanent wiring system, or an equipment-grounding conductor must be run with the circuit conductors and connected to the equipment-grounding terminal or lead on the appliance.

NOTE!

This manual does not cover every possible condition and situation that may occur. Use common sense and caution when installing, operating, and maintaining any appliance.

Installation

See the "Installation" chapter.

Overflow guard function

If the machine's water level rises above the normal level, the overflow guard function begins to pump water out and shuts off the water intake. If the water level has not dropped within 60 seconds, the program is terminated.

Transport/Winter storage

If the machine is to be transported or stored in unheated premises where the temperature can fall below freezing, do as follows:

- Empty the filter and the drain pump. See the "Care and maintenance instructions" chapter.
- Shut off the water to the washing machine, loosen the supply hose to the intake valve, and let the water run out from the valve and hose.
- After emptying the pump, a small amount of water may remain in the machine. This does not affect quality or damage the machine.

Disposal

When the machine has reached the end of its service life and is to be disposed of, it should immediately be made unusable by removing the door to the washing compartment. Contact your local authorities for information about where your machine should be disposed of and recycled in the proper way. The machine is manufactured and labeled for recycling.

SAVE THESE INSTRUCTIONS FOR FUTURE REFERENCE

Child safety

Keep an eye on children!

WARNING!



- Laundry detergents are corrosive, so always keep them out of reach of children.
- Should a child swallow detergent, give plenty to drink immediately, i.e., one or two glasses of milk or water. Do not try to induce vomiting. Seek medical advice immediately: The National Poison center phone number is 1-800-222-1222.
- Always close the door and start the appliance as soon as you put in the detergent.
- Always turn the power off to the machine when it is not in use.
- Always keep small children away from the machine when it is open. There may be some detergent residue left inside the machine.
- If laundry detergent gets in someone's eyes, rinse them with plenty of water for at least 15 minutes.

Activate child safety catch (for detergent compartment)

On the inside of the detergent compartment is a child safety catch.

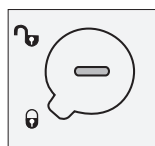

Activated child safety catch

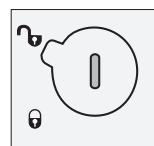

Inactivated child safety catch

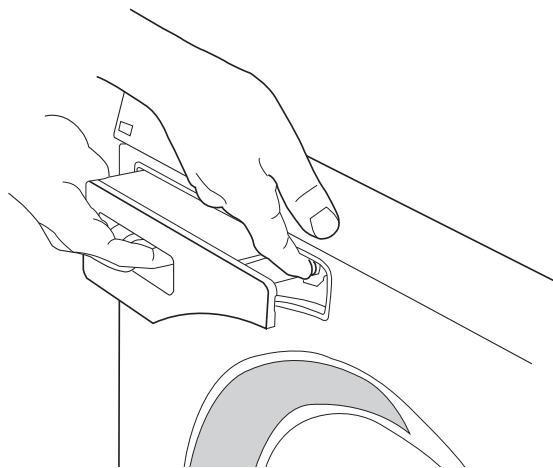

When the child safety catch is activated, you must press the release button to pull out the detergent compartment.

Parts of the washing machine

1. Main power switch
2. Detergent compartment
3. Program panel
4. Serial number plate (on inside of washer door)
5. Drain pump cover
6. Drain pump (behind cover)
7. Washer door

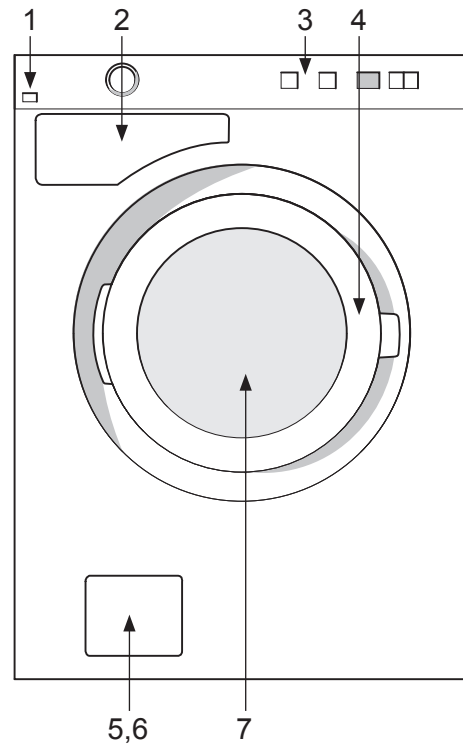

Detergent compartment

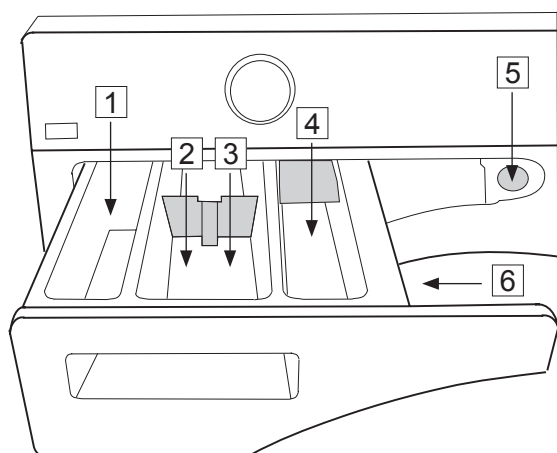

1. Pre Wash



2. Main wash with liquid detergent.
Use the separator.



3. Main wash with powder detergent.
Do not use the separator.



4. Fabric softener



5. Release button

6. Child safety catch

The detergent drawer automatically dispenses the detergent and fabric softener at the appropriate times. Simply pour the measured amounts of detergent and softener into the proper compartments (as illustrated) and close the drawer.

NOTE!

To avoid oversudsing, do not put detergent in the prewash compartment unless you are using one of the Heavy wash programs which has a prewash cycle.

Advice and tips before washing

Here are some tips that may help you before washing.

Sorting your laundry

Sorting your laundry

- how soiled they are
- color
- material

Clothing

1. Close zippers and Velcro straps so they won't damage fabrics.
2. New colored items may contain excess dye and should therefore be washed separately the first few times.
3. Turn delicate items inside out. This reduces the risk of burling and fading.
4. Empty pockets and wash them inside out if possible.

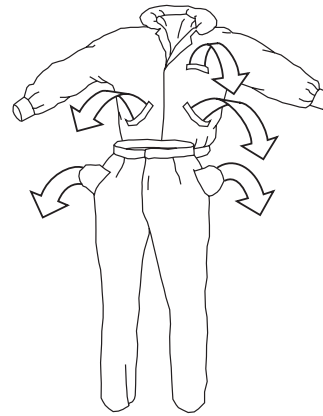





Laundry labels







Look at the item's laundry label. The table below shows suitable wash programs for different materials and wash loads. Using modern washing machines and detergents, such as compact detergents, you can usually wash at lower temperatures. It is a good idea to use trial and error to find out what produces the best results.

Advice and tips before washing



Wash cycle

-  Normal wash cycle
-  Permanent Press or Wrinkle Resistant setting
-  Gentle/Delicate setting
-  Hand wash only
-  Do not wash
-  Do not wring. Hang dry, drip dry, or dry flat

Wash water temperature

-  Maximum water temp 200° F/95° C
-  Maximum water temp 160° F/70° C
-  Maximum water temp 140° F/60° C
-  Maximum water temp 120° F/50° C
-  Maximum water temp 105° F/40° C
-  Maximum water temp 85° F/30° C





Bleach instructions

-  Any bleach when needed
-  Only non-chlorine bleach
-  Do not bleach





Dry clean symbol

-  Dry clean only





Tumble dry cycle

-  Machine dry
-  Normal setting
-  Permanent Press or Wrinkle Resistant setting
-  Gentle or Delicate setting
-  Do not tumble dry







Tumble dry heat setting

-  Any heat
-  High heat
-  Medium heat
-  Low heat
-  No heat/Air fluff

Special drying instructions

-  Line dry or hang to dry
-  Drip dry (do not spin or wring)
-  Dry flat
-  Dry in shade

Ironing instructions

-  Ironing is necessary
-  High temperature setting
-  Medium temperature setting
-  Low temperature setting
-  Do not iron or press with heat
-  Iron without steam

Advice and tips before washing

Coloured cotton

Colored cotton items labeled 140 °F (60 °C) should be washed at 140 °F (60 °C) the first time in order to remove any excess dye. If you do not do so, there is a risk that the color will run. Use detergent without bleach in order to preserve the color of the fabric.

Unbleached linen

Unbleached linen fabrics should be washed at 140 °F (60 °C), using detergent containing no bleach or optical whiteners. Heavily-soiled linen can occasionally be washed at higher temperatures, but not too often as the heat can destroy the linen's sheen and strength.

Wool

These fabrics are labeled either machine wash or hand wash. The Wool/Hand Wash program is at least as gentle as washing by hand.

Wool is especially sensitive to processes such as washing.

If you do not wish to spin dry, you can squeeze out the water using terrycloth towels. In this case select No spin.

To find out how to choose this setting, see the "Operating instructions" chapter. However, most garments can withstand a short spin. Choose a short spin by selecting a spin speed of 800 rpm or less.

Rayon fibers and synthetic fibers

Materials made of rayon fibers, such as viscose, and some synthetic fibers are very delicate and require much space to avoid wrinkling. Only half fill the drum when washing and choose a spin speed of 800 rpm or lower.

NOTE!

Viscose and acetates are fragile when wet.

Reducing allergic reactions

The washing machine has a Super Rinse option. Use this for people with sensitive skin, such as those with allergies and small children.

Economy and efficiency

You can save a lot of energy by not using higher temperature programs than necessary.

- Select Quick if you just need to freshen up shirts or exercise clothes, for example. This will save both water and energy.
- If you select a fast spin speed, this reduces energy consumption when drying in a tumble dryer or drying cabinet.
- Always wash with a full load when using the Sani, White, and White programs.
- Avoid pre-washing. Modern machines and detergents clean effectively without pre-washing. Pre-washing is only necessary for heavily soiled laundry.

Detergents

Eco-labeled detergents are less harmful to the environment.

Detergent overdosing does not give better washing results; it merely causes a greater impact on the environment.

Try to use less detergent, and increase only if you are not satisfied with the results.

Dyeing fabrics

If you want to dye fabrics in the machine, select the White program with the Super Rinse option. Select the temperature according to the dye manufacturer's recommendations.

Choose a low spin speed if the fabric to be dyed is a blended material, such as polyester/cotton.

NOTE!

Add the dye directly to the washing drum – not to the detergent compartment. After dyeing, you should run the machine empty using the same program. Use the normal amount of detergent.

Advice and tips before washing

NOTE!

Due to environmental concerns, we discourage the use of strong chemicals.

When using agents for bleaching or stain removal, there is a risk of rust (corrosion) and discoloration of the machine.

Liquid detergents

We don't recommend liquid detergents because they tend to produce more suds than powder detergents when used in water temperatures of 150° F or higher.

If you should try a liquid detergent, start with a very small amount, such as 1 to 2 tablespoons. Also, liquid detergent can be used for all programs without prewash, so add it into the main wash compartment.

Detergents

Laundry detergents are available in low-, normal- and high-sudsing formulas. A detergent's ability to clean is not relative to the amount of suds it produces. Excess suds in a front-loading washer actually interfere with the cleaning because they cushion the tumbling action. Also, high-sudsing detergents are more difficult to completely rinse out. The use of anything other than a low-sudsing detergent can cause severe oversudsing, which could cause suds to backup through the detergent compartment and run down the front of the washer onto the floor. If oversudsing occurs, run the wash through one or more rinse programs until all items are thoroughly rinsed. Remove the laundry then run the washer through a Normal wash program to get rid of any remaining detergent.

We recommend that you don't use bleach in your ASKO washer. The tumbling wash action, temperature control options, extended wash times and proper amount of detergent are sufficient to remove most stains.

Recommended powder detergents

ASKO washers use 50% to 75% less detergent than most other washers. This is because of their low water consumption and the fact that all the wash water is repeatedly circulated through the laundry, ensuring that all the detergent is fully utilized. We recommend that you use powder detergents made specifically for front-loading washers. These are sometimes called HE (High-Efficiency) detergents. Please visit our homepage www.askona.com to see the powder detergents we recommend for ASKO washers.

We recommend that you do not use any powder detergent that doesn't wash completely out of the detergent drawer.

Detergent Amounts Based on Water Hardness

The amount of detergent needed can vary due to differences in water hardness. To determine the water hardness in your area, contact your local water utility or area water softening company. The harder the water, the more detergent you may need. Refer to the chart below for the recommended detergent amounts based on water hardness. Remember, you should adjust the amount of detergent you use by small amounts until you find the correct amount.

Note that 12 grains and higher is extremely hard water and detergent alone may not be enough. You may need to use a water softener to maximize the performance of your washer. Also, in areas with hard water (9+) you may need to wash at lower temperatures to prevent hard water deposits from forming in the tank and wash system.

Amount of detergent to use

The amount of detergent needed varies among the different brands, but for most detergents, you need only one or two tablespoons. Using too much detergent can result in detergent residue being left in your clothes, which can cause them to appear gray or dingy. You should start with a small amount of detergent and increase it only if the cleaning results are unsatisfactory.

Additionally, you should never put detergent in the prewash compartment unless you are using a

Advice and tips before washing

wash program that has a prewash cycle. This could cause excess foaming, which could damage the machine.

The amount of detergent needed can also depend on the hardness of the water in your area. See the “Detergent Amounts Based on Water Hardness” section on the next page for more details.

Recommended detergent amounts based on water hardness

Detergent amounts		
Water hardness	Pre Wash	Main Wash
Soft (0-3 grains per gal.)	1 teaspoon	1 to 1-1/2 tablespoons
Medium (4-8 grains per gal.)	1 teaspoon	1 to 2 tablespoons
Hard (9+ grains per gal.)	1 teaspoon	2 to 3 tablespoons

Operating instructions

WARNING!



To reduce the risk of fire, electric shock, or injury to persons, read the IMPORTANT SAFETY INSTRUCTIONS before operating this appliance.

1 Sort your laundry.

See the "Advice and tips before washing" chapter.

Place underwired bras in a laundry net.

Empty pockets. Coins, nails, and the like can cause damage to the machine and fabrics. See the "Advice and Tips" section before washing.

2 Turn on the main power switch

3 Open the washer door and load the laundry

If the washer door is closed, press the Door Opening button (key symbol). The door opens once all water has drained from the machine. Load the laundry. The wash program chart shows how much laundry can be washed with each program.

4 Add detergent and fabric softener, as required

The detergent packaging will have recommendations for how much detergent you should use. The machine holds 18 lb (8 kg) of laundry. If you only have a small amount of laundry in the machine, you can reduce the amount of detergent used.

Powder detergent

Pour the powder into the main wash compartment, and pre-wash compartment as well if desired.

Liquid detergent

When using liquid detergent, follow the detergent manufacturer's recommendations. For thick detergent, we always recommend using a wash ball. Use the separator in the main detergent

compartment. Pour the liquid detergent into the front section of the detergent compartment.

Wash ball or net

If you use a wash ball or net, place it directly in the drum and select a program without pre-wash.

NOTE!

Detergent overdosing does not give better washing results; it merely causes a greater impact on the environment.

Try using less detergent, and increase only if you are not satisfied with the results.

Fabric softener

Pour the fabric softener into the compartment with the  symbol. Follow the recommendations on the fabric softener packaging.

NOTE!

Do not fill above the compartment's maximum fill level. Otherwise fabric softener will be dispensed too early, which impairs the washing effect.

WARNING!



To reduce the risk of fire, electric shock, or injury to persons, read the IMPORTANT SAFETY INSTRUCTIONS before operating this appliance.

Operating instructions

5 Select the program

You select a program by turning the program selector. An LED lights up beside the selected program. Use the option buttons to select any options.

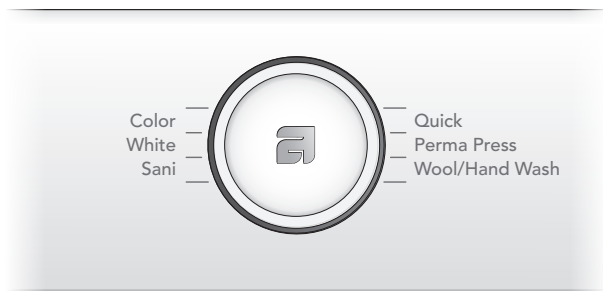

1. Sani

Program for heavily soiled laundry, with dirt that needs to be fully dissolved before the main wash. A pre-wash is used to do this. The machine adapts the program time and water consumption to the load size.

2. White

A standard program for lightly to moderately soiled laundry. Garments worn next to the skin ought to be washed at 140 °F (60 °C). Follow the washing instructions for each garment. The machine adapts the program time and water consumption to the load size.

3. Color

A standard program for lightly soiled laundry that usually comes clean at 104 °F (40 °C). Follow the washing instructions for each garment. The machine adapts the program time and water consumption to the load size.

4. Quick

Program for normally soiled cotton and/or linen clothes for daily use. Follow the washing instructions for each garment.

5. Perma Press

Program for synthetics, blended materials, and permanent press cotton. Suitable for shirts and blouses. Follow the washing instructions for each garment. Many synthetics will come clean at 104 °F (40 °C). The spin speed is 800 rpm.

6. Wool/Hand Wash

A gentle laundry program for wool, silk, and garments that should be washed by hand. The temperature is 86 °F (30 °C). The spin speed is 800 rpm.

Operating instructions

Program chart

Program	Pre Wash	Temp. °F	Number of rinses	Spin Speed rpm	Max. load (lb)	Water consumption (approx. gallon)	Energy consumption (approx. kWh)	Program time (approx. hrs and min.)
1. Sani		140	5	1200	18	20,3	1.10	2:40
2. White		140	3	1200	18	15,9	1.2	1:40
3. Color		104	3	1200	18	15,9	1.2	1:40
4. Quick		-	2	1200	9	6,6	0.1	0:40
5. Perma Press		104	3	800	6	7,9	0.4	1:20
6. Wool/Hand Wash		86	3	800	6	18,5	0.5	0:50

Operating instructions

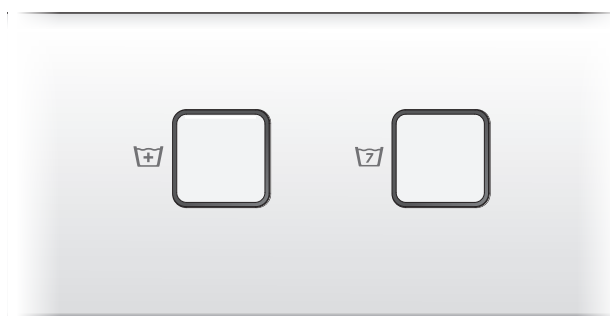

6 Select options

You can select options to adjust the wash program to suit your own specific requirements. The available options depend on the selected program. If the option is available for the selected program, the symbols lights up when you press the button.

The machine will remember the options you select for each program (with one exception – Delayed Start). You can still change the selected options the next time you select a particular program.

Super Wash

Super Wash can be selected to better dissolve difficult stains and heavy soiling on clothing. This option adds a cold pre-wash and the wash time in cold water is extended by approximately six minutes. The main wash time is also extended.

- Select Super Wash by pressing the button by the symbol.
- An LED next to the button lights when this option is activated.

Super Rinse

Use the Super Rinse option if you want to increase the number of rinses. The maximum number of rinses is seven and varies depending on the selected program. Recommended for persons with extremely sensitive skin and/or in areas with very soft water. This option cannot be selected with Quick, Rinse, or Spin & Drain.

- Select Super Rinse by pressing the button under the symbol.
- An LED next to the button lights when this option is activated.

7 Close the washer door and press the Start/Stop button



Stopping or changing a program

You can stop a program by pressing the Start/Stop button for three seconds. To restart the machine, select a new program, add any extra detergent needed, and press the Start/Stop button.

NOTE!

Do not open the detergent compartment while the machine is running.

Operating instructions

8 Once the program has finished

Once the program has finished, all six LEDs around Start/Stop and the Door Opening button light up for 2 minutes. The machine then turns off.

The washer door opens automatically once the program has finished. If you want to deactivate the Automatic Door Opening function, see the "Selecting settings" section.

- Remove the laundry.

If you have small children or pets at home, close the washer door once you have removed the laundry.

You can change the following settings:

Automatic Door Opening.

Door opening

If you choose Automatic Door Opening, the washer door will open once the program has finished.

1. Turn off the machine using the main power switch.
2. Press and hold the Super Rinse button and then switch on the main power switch.
3. If the LEDs around the Door Opening button light, automatic door opening is activated. If the LEDs do not light, the setting is not activated.
4. Press the Super Rinse button to change the setting.
5. Press the Door Opening button to save the setting.

Care and maintenance instructions

Cleaning the trap and the drain pump

The washing machine has a trap where small items such as coins, buttons, and hairpins can collect. To clean the trap and the drain pump, do as follows:

1. Make sure that the main power switch is off.



2. Open the door.

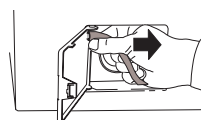

3. Unhook the drain hose from the connector inside the door and drain the water into a suitable container, such as a shallow bowl.

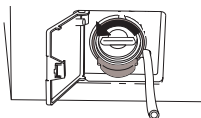

4. Turn the cover counter-clockwise to open the pump. Remove the cover.

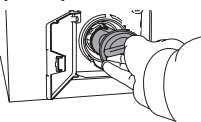

5. Remove any items and debris from the pump housing and cover. Also check that the pump impellers at the back rotate.

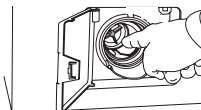

6. Screw on the cover, replace the drainage hose on the hatch pin, and close the hatch.

Cleaning the detergent compartment

Pull out the detergent compartment using the release button.

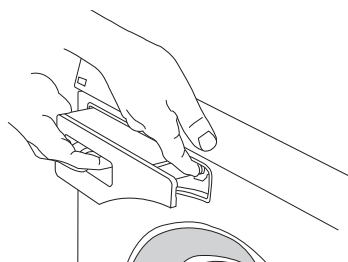

Rinse the compartment and scrub it clean. The cover in the fabric softener compartment can be removed.

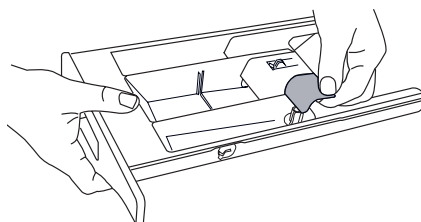

NOTE!

Do not run the detergent compartment through a dishwasher!

Cleaning the outside of the machine

Clean the outside of the machine and the program panel with a mild cleaner. Do not use any solvents, as these can damage the machine.

NOTE!

Do not hose down the machine with water!

Cleaning the inside of the machine to avoid unpleasant smells

Modern detergents often allow laundry to be washed at low temperatures. This means that small deposits can build up in the machine. These, in turn, may lead to unpleasant odors developing.

To avoid this, we recommend running a 203 °F (95 °C) wash program once a month. When you do this, use a small quantity of detergent. It is not necessary to put any laundry in the machine.

Care and maintenance instructions

Rinse holes under the paddle

If you suspect that objects such as nails or paper clips may have fallen into the wash drum, you should check the space under the paddles. Such objects can rust and cause spots on clothing. Nails and other sharp objects can cause holes in fabrics.

Do as follows:

1. Insert a screwdriver or similar tool into the hole on the paddle as illustrated and carefully push to the left.

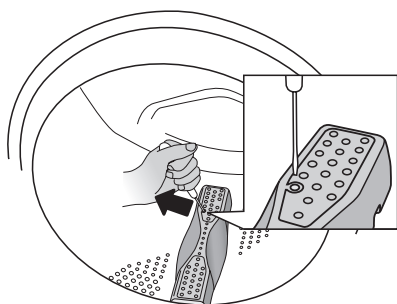

2. Use your other hand to grasp the paddle and pull it toward you.

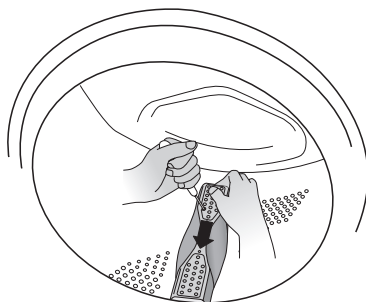

3. Lift the paddle.
4. Remove any objects.
5. Place the paddle in the mounting hole with the F-mark toward you. Ensure that all the paddle fasteners are in their holes in the drum. Push it in until it catches.

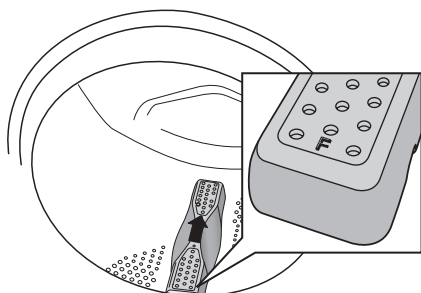

If you have hard water

If you live in an area with hard water (high limescale content), a grayish-white coating may form on the wash drum. To remove this coating, pour approximately 20 gram (1 oz) of citric acid into the wash drum and run any 203 °F (95 °C) program. Repeat if necessary.

Troubleshooting

The washer door will not open

1. Check that the main power switch is on.
2. Is there power? Check your home's fuses (circuit breakers). The washer door cannot be opened with the door opening button (with the key symbol) if the power is off.

If nothing else works, the washer door can be opened as follows:

WARNING!



The door may only be opened manually if the electric power is cut and the machine has been drained of water.

- A Empty the water from the machine. See "Cleaning the trap and the drain pump" in the "Care and maintenance instructions" chapter.
- B Ensure that the main power switch is turned off and that the plug has been removed from the wall socket.
- C Take the emergency door opening tool and place it in the gap on the right side of the washer door lock. The tool is attached to the rear of the detergent compartment. Remove the detergent compartment from the machine and remove the emergency door opening tool.
- D Push the tool upward to open the washer door.

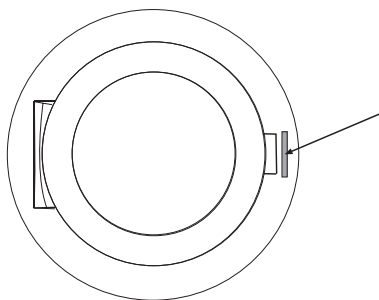

If in the future the washer door does not open when the wash program has finished, call the Customer Care Center.

The machine will not start

1. Is the washer door properly closed? Push it firmly.
2. Is there power? Check the fuses and residual current devices (circuit breakers) in the building.

After power failure

Press the main power switch to resume the current program.

Wet laundry still in the machine

A small load can under certain circumstances cause imbalance (see "L4 Imbalance"). Rearrange the load and start the spin program, or load more laundry and restart the washing program.

Troubleshooting

Error messages

If a fault occurred during the program cycle, an LED will flash next to Start/Stop and the Door Opening button.

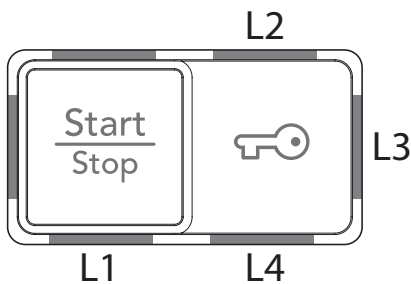

After taking the measures described below, turn off the machine to exit error message mode.

L1 Overflow Fault

1. Shut off the water tap.
2. See "Drainage error".

L2 Water Outlet Fault

Check:

- that nothing is stuck in the drain hose outlet.
- that the drain pump is not blocked by foreign objects. Clean the pump. See the "Care and maintenance instructions" chapter.
- that there are no kinks in the drainage hose.

After taking action, run the Drain program or press the Door Opening button (key symbol) to empty the machine. If this does not resolve the problem, call the Customer Care Center.

L3 Water Inlet Fault

Check:

- that the tap on the water pipe is open.
- that the filter in the machine's fill valve is not blocked.

Action:

1. Shut off the water tap.
2. Unscrew the hose.
3. Clean the filter in the machine's fill valve.
4. Screw the hose back on.
5. Turn on the tap.
6. Run the program again to check whether the error has been fixed.
7. If this does not resolve the problem, call the Customer Care Center.

L4 Imbalance

The machine stops the spin cycle if there is too much imbalance. The washing machine restarts the spin cycle and hopefully the laundry is better distributed in the drum. This procedure can be repeated up to 10 times. If the machine still fails to find a good balance, the program jumps to the next step. The error message requires no action.

Technical information

Technical data

Height:	33 1/2" (850 mm)
Width:	23 1/2" (597 mm)
Depth:	23 7/8" (606 mm)
Weight:	161 lb (73 kg)
Cylinder volume:	15,9 gal (60 l)
Max. laundry capacity:	18 lb (8 kg)
Spin speed (rpm):	400-1200
Rated power:	See serial number tag and rating plate.
Heater output:	See serial number tag and rating plate.
Water pressure:	14-145 psi
Wash drum and liquid compartment material:	Stainless steel
Outer casing material:	Powder-coated and hot-galvanized sheet steel or stainless steel.
Water connection:	59" (1.5 m) pex pipe
Drain:	67" (1.7 m) polypropylene hose

Transport protection

Remove the three transport bolts and the plastic plugs for locking the machine for transport before using the machine.

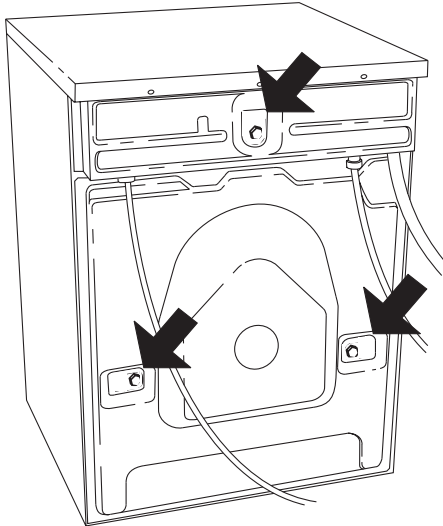

1. Loosen and remove the bolts as illustrated below.

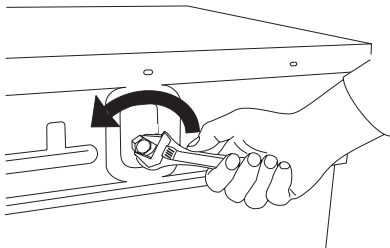

2. To remove the plastic plugs that held the bolts, squeeze together and pull out.

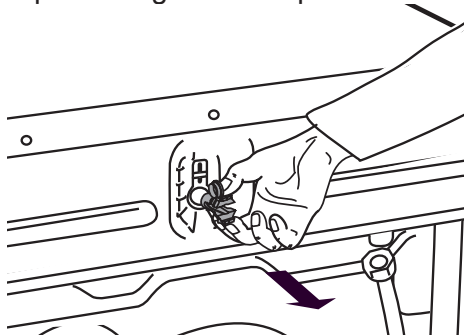

3. Remove the plastic covers from the plugs. Push the plastic covers into the three holes that contained the plugs. Save the plastic plugs in case the machine is moved in the future.

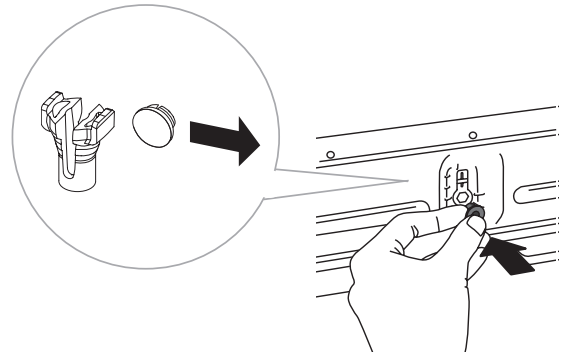

NOTE!

If the machine is to be transported, the bolts and plastic plugs for locking the machine during transport must be installed to prevent damage to the machine through shaking. If the transport bolts or plastic plugs have been lost, you can order new ones from your retailer.

Article number	Designation
80 882 77	Screw
80 901 05	Plastic plug, transport lock

Order three of each item!

Installation

Read these instructions carefully and completely before you install the machine. The installation should be carried out by a qualified person who is familiar with all local codes and ordinances for electrical and plumbing connections.

Cosmetic damage must be reported to your dealer within five days from the date of purchase. After unpacking the washer, thoroughly check the unit for cosmetic damage.

Leveling the machine

It is important that the machine is level to prevent excessive vibrations during spin cycles. Each foot of the washer is adjustable, so you can level the washer on any surface. Once it is level, securely tighten the lock nuts on the feet to prevent excessive vibration during spin cycles.

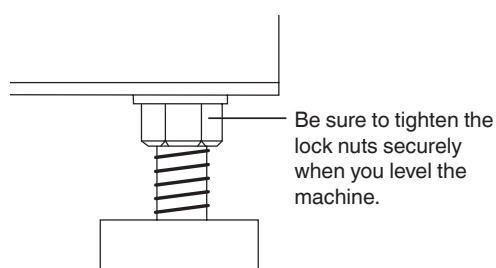

Water supply connection

Since ASKO washers have a built-in heating element, you only need a cold water inlet. The connection should be made by someone who is sufficiently skilled. Use the hose supplied with the washer. (The inlet hose is marked for correct connection.) The water pressure must be in the range 15–146 PSI. A valve should be fitted on the water supply pipe. If a new supply pipe has been installed for the washer, it should be flushed thoroughly to remove any foreign particles that might clog the filter in the fill valve.

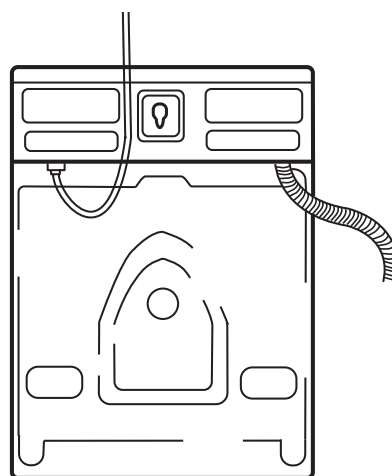

NOTE!

If the unit is installed on a second storey, follow local building codes. We recommend installing a drip pan.

Installation

Drain outlet connection

The machine is supplied with the outlet hose already attached. The hose should be extended over a suitable sink edge or drain pipe at a height of 24" to 36" (610 mm to 914 mm) above the bottom of the unit. (The lower height is preferable.) Make sure the hose is not kinked.



NOTE!

If the hose is extended, the internal diameter of the coupling must not be less than 1/2".

WARNING!



Do not extend the drain hose higher than 36" (914 mm) from the bottom of the unit.

Electrical Connections

The machine is delivered ready-fitted with a plug and is intended for connection to an ASKO Dryer, which is equipped with a matching receptacle. The plug supplied with the washer can only be used with an ASKO Dryer. If the washer is used separately or with another dryer, it must be on a separate 208-240 V single-phase circuit.

If the machine is to be used in a wet area, the supply must be protected by a residual current device.

As supplied: 208-240 V, 60 Hz, 2000W heating element, 15A fuse required.

WARNING!



Connection to a permanently wired supply point must be made only by a qualified electrician

Grounding instructions

This appliance must be grounded. In the event of malfunction or breakdown, grounding will reduce the risk of electric shock by providing a path of least resistance for electric current. This appliance is equipped with a cord having an equipment-grounding conductor and a grounding plug. The plug must be plugged into an appropriate outlet that is properly installed and grounded in accordance with all local codes and ordinances.

Freestanding installation

The washer can be placed next to the dryer. It is essential that the machine is leveled and the locknuts are tightened to prevent excessive vibration during spin cycles. Also be sure to leave a minimum of 1/2" of space between the washer and the dryer. The height adjustment for the washer is 33 1/2" to 34 1/2" (850 mm to 876 mm). Do not raise it higher than 34 1/2" (876 mm).

WARNING!



Improper connection of the equipment-grounding conductor can result in a risk of electric shock. Check with a qualified electrician or serviceman if you are in doubt as to whether the appliance is properly grounded.

Do not modify the plug provided with the appliance. If it will not fit the outlet, have a proper outlet installed by a qualified electrician.

Stacked installation

ASKO washers should never be stacked on a counter or a dryer. You can, however, stack an ASKO dryer on an ASKO washer. Refer to your Dryer Use and Care Guide for instructions on how to do this.

Installation

Built-in installation

ASKO washers can be installed beneath a cabinet or worktop with a height of 34" to 35" (863 to 889 mm) or in a closet. There must be a gap of about 1/2" (12 mm) all around the machine, including between the rear edge of the machine's top panel and the back wall. The opening width must be at least 24 1/2" (622 mm). Space must also be available for the fill and drain hoses. See the illustration below for measurements and positions. If the washer is installed in a closet the door must be left open while the washer is running.

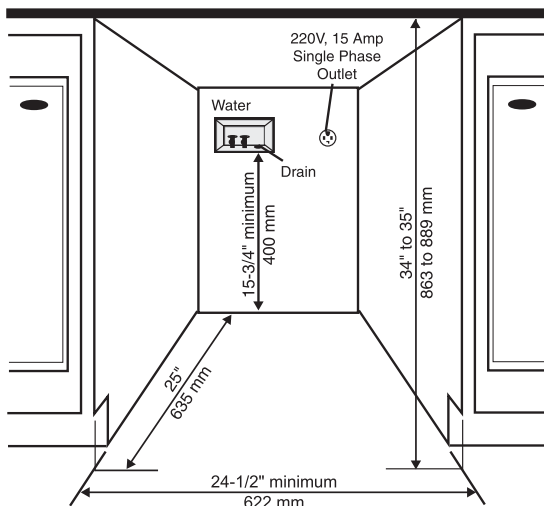

If the drain outlet is higher than 24" (610 mm), the connections will need to be recessed.

Service

Limited Warranty – Residential Appliances

ASKO Distribution North America, LLC. (hereinafter “ASKO”) warrants the original purchaser (the “ASKO Customer”) of the ASKO product (the “ASKO Product”), who purchased the appliance from a distributor, dealer, manufacturer representative or other seller who has been authorized by ASKO (“Authorized ASKO Dealer”), that this ASKO Product is free of defects in material and workmanship, subject to the terms and conditions set forth herein. The limited warranty covers parts and labor, except as set forth in this Limited Warranty. Service must be provided by an ASKO designated service company. YOUR SOLE AND EXCLUSIVE REMEDY UNDER THIS LIMITED WARRANTY SHALL BE PRODUCT REPAIR AS PROVIDED HEREIN. The limited warranty is valid only in the United States or Canada and applies only when the appliance is used in the country in which it was purchased. Proof of original purchase date is required to obtain service under this limited warranty.

Residential ASKO Products Used Exclusively for Household/Personal Purposes:

Two (2) Years limited Warranty – Any warranty service claims for residential ASKO Products must be filed with ASKO within two (2) years from date of purchase.

Residential ASKO Products Not Used Exclusively for Household Purposes, used Commercially or Use in marine, Mobile or Aeronautical Applications:

One (1) Year limited Warranty – Any warranty service claims for ASKO Products not used exclusively for household and personal use, used commercially or used in marine, mobile, or aeronautical application must be filed with ASKO within One (1) year from date of purchase.

ITEMS EXCLUDED FROM WARRANTY

This limited warranty does not cover:

1. Replacement parts or repair labor if this appliance is used in a manner that is

inconsistent to published user or operator instructions and or/or installation instructions.

2. Service calls to correct the installation of your appliance, to instruct you on how to use your appliance, to replace or repair house fuses, or to correct house wiring or plumbing.
3. Consumable parts are excluded from warranty coverage.
4. Damage resulting from accident, alteration, misuse, abuse, fire, flood, acts of God, improper installation, installation not in accordance with electrical or plumbing codes, or use of products not approved by ASKO.
5. Cosmetic damage, including scratches, dents, chips or other damage to the finish of your appliance, unless such damage results from defects in material or workmanship and is reported to ASKO within 5 days from date of purchase.
6. Pickup and delivery. This appliance is intended to be repaired in your home.
7. Repairs to parts or systems resulting from unauthorized modifications made to the appliance.
8. Expenses for travel and transportation for product service if your appliance is located in a remote area where service by an authorized ASKO servicer is not available.
9. The removal and reinstallation of your appliance if it is installed in an inaccessible location or is not installed in accordance with ASKO’s published installation instructions.
10. Replacement parts or repair labor on appliances with original model/serial numbers that have been removed, altered or cannot be easily determined.

DISCLAIMER OF IMPLIED WARRANTIES
YOUR SOLE AND EXCLUSIVE REMEDY UNDER THIS LIMITED WARRANTY SHALL BE PRODUCT REPAIR AS PROVIDED HEREIN. ASKO SHALL NOT BE LIABLE FOR INCIDENTAL OR CONSEQUENTIAL DAMAGES. Some states and provinces do not allow the exclusion or limitation of incidental or consequential damages, so these limitations and exclusion may not apply to you. This warranty gives you specific legal rights,

Service

and you also may have other rights that vary from state to state or province to province.

If you think you need repair service, first see the "Trouble Shooting" section of the Use & Care Guide.

If you are unable to resolve after checking "Trouble Shooting" additional help can be found by calling ASKO Customer Care at 1-800-898-1879

Before contacting the Customer Care Center

Before you contact the Customer Care Center, make sure you know the model designation, type designation, and serial number.

The model designation (1) can be found on the panel. The type designation (2) and serial number (3) can be found on the type plate on the inside of the washer door.

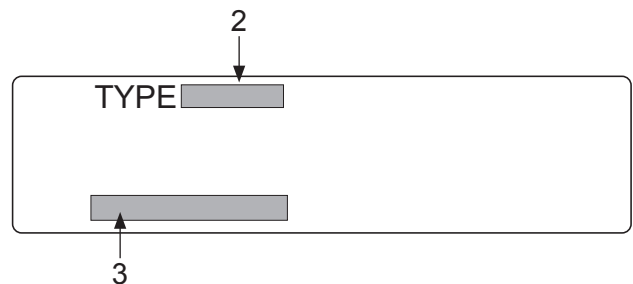
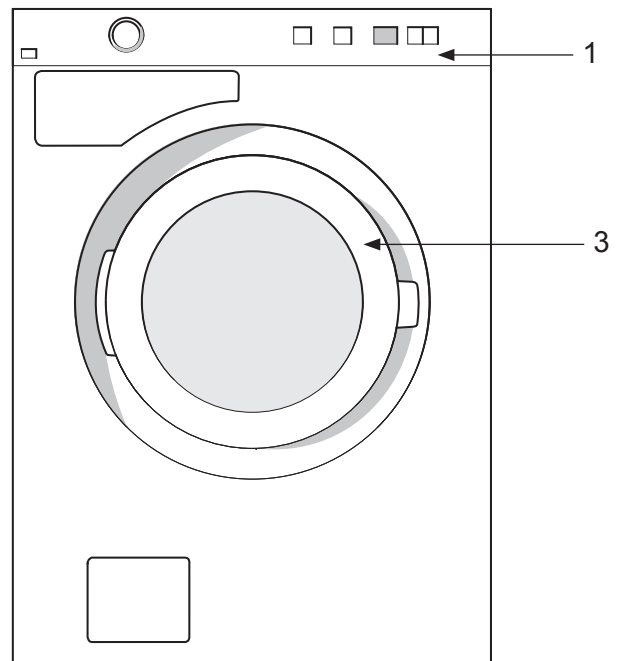

Should you need further assistance, you can write to ASKO Appliances with any questions or concerns at the address below:

ASKO Distribution North America, LLC.
Customer Care Center
PO Box 44848
MADISON WI 53744

Notes

QUICK GUIDE

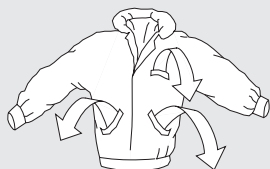

1.

SORT THE WASHING, OPEN THE WASHER DOOR AND LOAD THE WASHING

Refasten zips.

Look at the item's laundry label.

Sort the washing according to how soiled it is, colour and material.

NB! Place underwired bras in a laundry net.

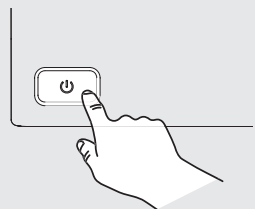

2.

TURN ON THE MAIN POWER SWITCH

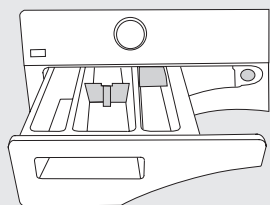

3.

ADD DETERGENT AND FABRIC SOFTENER, AS REQUIRED

The detergent packaging will have recommendations for how much detergent you should use. With only a small amount of washing in the machine, you can reduce the amount of detergent used.

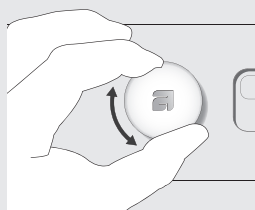

4.

SELECT A PROGRAMME

You select a programme by turning the programme selector. The selected programme is shown in the display.

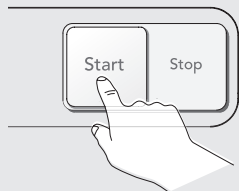

5.

CLOSE THE WASHER DOOR AND PRESS THE START BUTTON

The time remaining is shown in hours and minutes.

We reserve the right to make changes.

ASKO

Swedish quality since 1950

www.askona.com

 WM70.1
W6324W US/CA



en (01-14)