



PRO GRAND® STEAM & PRO GRAND RANGES 27-INCH DEPTH

Pretty only goes so far in the kitchen. When performance matters, when food and cooking matter, the Pro Grand Steam Range delivers. With its award-winning steam & convection oven, exclusive Star® Burners, and a convenient warming drawer, the Pro Grand Steam Range is the most versatile range on the market.

Expect better taste, texture and quality. Expect faster, easier defrosting, steaming, baking and reheating. Proudly built in America, this range is yet another shining example of how Thermador is providing Real Innovations for Real Cooks®.

PRO GRAND® STEAM RANGE FEATURES & BENEFITS

★ SEVEN COOKING OPTIONS

The only range in the market with a steam and convection combination oven, plus a full-size convection oven and a warming drawer. This Ultimate Culinary Center® features seven distinct cooking options that will forever change the way real cooks cook.



★ EXTRALOW®

This exclusive feature provides the widest variety of temperature control of any simmer system available, cycling the burner on and off to as low as 100 degrees.



CONVECTION OVEN

Thermador's True Convection system directs heat to cook food faster and more evenly with gourmet results.



★ 22K BURNER

Our powerful sealed Star® Burner delivers an industry-leading 22,000 BTU of pure cooking power for better searing and faster boiling.



★ STEAM AND CONVECTION OVEN

The award-winning oven offers three distinct cooking variations: Steam only, Convection only or Steam & Convection Cooking which makes food crisp on the outside and moist on the inside, just like it was being served at a 5-star restaurant.



GRILL ACCESSORY

Our grill accessory (sold separately) features a fusion coated surface that is easy to clean and dishwasher-safe.



★ WARMING DRAWER

The spacious 1.1 cubic-foot drawer can hold and warm up to 10 dinner plates on an all glass smooth surface. The heated glass technology provides uniform heat and is easy to clean.



12-INCH REMOVABLE GRIDDLE

Our 12-inch fusion coated griddle is thermostatically controlled to deliver consistent, even heating across the entire surface. It is also removable for easy cleaning or interchange it with our grill accessory.



MODEL SHOWN: PRD48JDSGU PRO GRAND® STEAM RANGE

PRO GRAND® STEAM RANGE FEATURES & BENEFITS



★ OUR EXCLUSIVE, PATENTED STAR® BURNER

The Star Burner's unique shape isn't just for show. The Star delivers 56% more coverage with superior flame spread and a reduced cold spot for faster and more even heating across any size pan.



★ HYDRAULIC SOFTCLOSE® HINGES

Hydraulic SoftClose hinges prevent slamming and ensure ultra smooth closing of both ovens and the warming drawer.

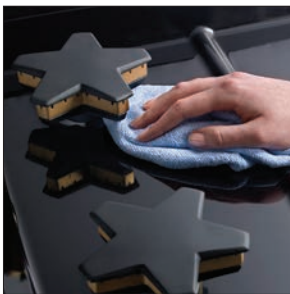

★ QUICKCLEAN BASE®

The raised pedestal burner and porcelain maintop have been crafted for perfect integration and easy cleanup. A hand and sponge fit easily under each burner to wipe the surface clean and a teardrop emboss reduces food buildup near the base.



TELESCOPIC RACKS

Full Access® telescopic racks glide smoothly on ball bearings, allowing them to expand completely for safe, easy access to your meal. Plus, their robust construction safely supports the heaviest dishes while integrated easy-grip handles make them easy to use.



VERSATILE DESIGN OPTIONS

Pro Grand Ranges feature striking stainless steel feet or you can add a stainless steel toe-kick accessory for a sleek, finished look.

★ FASTEST SELF-CLEAN

In just 2 hours, the interior walls and rack supports become perfectly clean, thanks to the fastest self-cleaning cycle on the market.



STAR-K CERTIFIED

Thermador Pro Grand Ranges are Star-K certified making it possible to use them on Holy Days and the Sabbath.



EXTRA-LARGE CAPACITY OVEN

The extra-large capacity 5.1 cubic foot steam and convection oven offers maximum space for best-in-class cooking while the compact 1.4 cubic foot capacity convection oven lets you prepare smaller meals or multiple dishes when entertaining.

★ THERMADOR EXCLUSIVE

PRO GRAND® RANGES

FEATURES & BENEFITS



★ OUR EXCLUSIVE, PATENTED STAR® BURNER

The Star Burner's unique shape isn't just for show. The Star delivers 56% more coverage with superior flame spread and a reduced cold spot for faster and more even heating across any size pan.

The Star Burner's coverage area allows for more ports and more flame distribution than a round burner.



35 ports / 16 3/4" perimeter

28 ports / 10 3/4" perimeter

The design of the Star Burner offers greater heat coverage, and a smaller cold spot, making it ideal for any pan size.



★ FASTEST SELF-CLEAN

In just 2 hours, the interior walls and rack supports become perfectly clean, thanks to the fastest self-cleaning cycle on the market.



★ EXTRALOW®

Our ExtraLow feature provides the widest variety of temperature control of any simmer system. It cycles the Star Burner on and off to maintain temperatures as low as 100°. Each and every Thermador Pro Grand Range features four ExtraLow burners.



★ 22K BURNER

Our powerful sealed Star Burner delivers an industry-leading 22,000 BTU of pure cooking power for better searing and faster boiling.

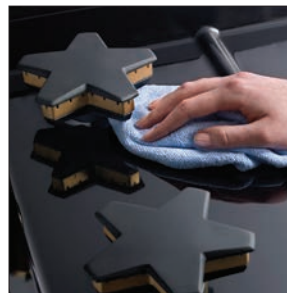

★ QUICKCLEAN BASE®

The raised pedestal burner and porcelain maintop have been crafted for perfect integration and easy cleanup. A hand and sponge fit easily under each burner to wipe the surface clean and a teardrop emboss reduces food buildup near the base.



★ HYDRAULIC SOFTCLOSE® HINGES

Hydraulic SoftClose hinges prevent slamming and ensure ultra smooth closing of the oven door.



EXTRA-LARGE CAPACITY OVEN

Our 36-inch and 48-inch dual-fuel ovens offer a maximum capacity of 5.7 cubic feet and can accommodate full-sized commercial sheet pans.

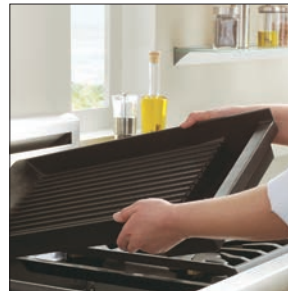

12-INCH REMOVABLE GRIDDLE

Our 12-inch fusion coated griddle is thermostatically controlled to deliver consistent, even heating across the entire surface. It is also removable for easy cleaning or interchange it with our grill accessory.



VERSATILE DESIGN OPTIONS

Pro Grand Ranges feature striking stainless steel feet or you can add a stainless steel toe-kick accessory for a sleek, finished look.

THIRD ELEMENT CONVECTION SYSTEM

Thermador's True Convection system directs heat to cook foods more evenly with gourmet results and 25% time savings.



STAR-K CERTIFIED

Thermador Pro Grand Ranges are Star-K certified making it possible to use them on Holy Days and the Sabbath.



GRILL ACCESSORY

Our grill accessory (sold separately) features a fusion coated surface that is easy-to-clean and dishwasher-safe.



TELESCOPIC OVEN RACKS

Full Access® telescopic racks glide smoothly on ball bearings, allowing them to extend completely for safe, easy access to your meal. Plus, their robust construction safely supports the heaviest dishes while integrated easy-grip handles make them easy to use.

PRO GRAND® RANGES

PLANNING INFORMATION

MODEL OPTIONS

There are two sizes of Thermador Pro Grand® Ranges to choose from—36-inch and 48-inch—in your choice of all-gas or dual-fuel configurations. All models are 27-Inch deep and available in stainless steel or exclusive models available with porcelain cooktop. Dual-fuel models can be converted to Liquid Propane (LP) using the included kit. All-gas models are available in Natural Gas or Liquid Propane (LP) and should be ordered separately from the factory. Be sure to reference the correct model information in this design guide.

INSTALLATION CONSIDERATIONS

The information in this design guide provides key features, product dimensions, cutouts and installation specifications. Before installing a Thermador Pro Grand Range, be sure to verify the cutout dimensions and electrical / gas connections. Also, always consult with the installation manual packed with the product for complete details before installing.

ELECTRICAL AND GAS SPECIFICATIONS

Be sure your appliance is properly installed and grounded by a qualified technician. Installation, electrical and gas connections, and grounding must comply with all applicable local codes.

GAS REQUIREMENTS AND HOOKUP

Verify that the type of gas being used at the installation site matches the type of gas used by the appliance. If an LP kit is utilized, conversion from natural gas to propane must be done by qualified service personnel only. Please refer to the LP Conversion Instructions for further information.

A manual gas shut-off valve must be installed external to the appliance, in a location accessible from the front, for the purpose of shutting off the gas supply. The supply line must not interfere with the back of the unit.

NATURAL GAS REQUIREMENTS:

Inlet Connection: 3/4" NPT external, 1/2" NPT internal (Minimum 3/4" diam. flex line)

Supply Pressure: 6" min. to 14" max. water column (14.9 to 34.9 mb)

Manifold Pressure: 5" water column (12.5 mb)

PROPANE GAS REQUIREMENTS:

Inlet Connection: 3/4" NPT external, 1/2" NPT internal (Minimum 3/4" diam. flex line)

Supply Pressure: 11" min. to 14" max. water column (27.4 mb to 34.9 mb)

Manifold Pressure: 10" water column (24.9 mb)

DUAL-FUEL:

Thermador Pro Grand Dual-Fuel Ranges are dual rated, designed to be connected to either 240/208V AC, 60 Hz, 4-wire, single-phase power supply. The connection may be made with a range supply cord kit (purchased separately) or by hard-wiring to the power supply. A dedicated circuit breaker is required.

MODEL	REQUIRED CIRCUIT BREAKER
	240/208V AC, 60Hz
PRD366JGU	35 Amp
PRD364JDGU	35 Amp
PRD486JDGU	50 Amp
PRD48JDSGU	50 Amp

ALL-GAS:

Thermador Pro Grand All-Gas Ranges are equipped with a 3-wire plug and are designed to be connected to a 120V AC, 60 Hz, single-phase power supply. A dedicated circuit breaker is required.

MODEL	REQUIRED CIRCUIT BREAKER
	120V AC, 60Hz
PRG366JG – NG	15 Amp
PRL366JG – LP	15 Amp
PRG364JDG – NG	20 Amp
PRL364JDG – LP	20 Amp
PRG486JDG – NG	20 Amp
PRL486JDG – LP	20 Amp

IMPORTANT: The cord supplied with gas ranges having an electric griddle requires a NEMA 5-20 receptacle as shown here. Local codes may require a different wiring method. A dedicated 20 Amp service is required for proper operation.

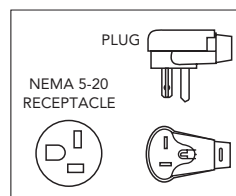

ELECTRICAL AND GAS LOCATIONS

Typical placement of the electrical and gas supply can be found within the "Cutout and Range Dimensions" located on the product pages. Alternate placement within the supply zone is acceptable. Dual-Fuel ranges may be connected to the power supply with a range supply cord kit (sold separately) or by hard-wiring to the power supply. All-gas ranges may be connected to the power supply with the supplied range cord or by hard-wiring. It is the responsibility of the installer to provide the proper wiring components (cord or conduit and wires) and complete the electrical connection as dictated by local codes and ordinances and / or the National Electric Code. The units must be properly grounded.

Installation of the range must be planned so that the rough-in of the junction box for the receptacle or conduit connection will allow maximum clearance to the rear of the unit.



WARRANTY

Limited warranty parts and labor (2 year)

See page 310 for additional warranty details.



WARNING: All ranges can tip, causing injury. Install anti-tip device packed with range.

Thermador Pro Grand® Ranges are CSA approved.



VENTILATION REQUIREMENTS

We strongly recommend that a Thermador Professional® Wall or Island Hood or Custom Insert be installed with all Thermador Pro Grand Ranges. Downdraft ventilation should not be used. Do not install a microwave-hood combination above the cooktop, as these types of units do not provide the proper ventilation and are not suitable for use with Thermador Pro Grand Ranges.

For high output gas cooktops (60,000 BTU or greater), the minimum of one (1) CFM of ventilation per 100 BTU is recommended. If the cooktop has a grill or griddle, add 150 CFM to the estimated blower capacity. Additional blower capacity may be required for longer duct runs.

The following table indicates the ventilation hood options that are recommended for use with Thermador Pro Grand Ranges. Refer to the Ventilation section or www.Thermador.com for a complete selection of Professional ventilation options, blowers, and accessories.

WIDTH	CONFIGURATION	VENTILATION OPTIONS
36"	4 Burners w/Grill or Griddle 6 Burners	36" or 42" Pro Wall Hood 36" Custom Insert with optional blower 42" or 48" Island Hood with optional blower
48"	6 Burners w/Grill or Griddle	48" or 54" Pro Wall Hood 48" Custom Insert with optional blower 54" Island Hood with optional blower

PRO GRAND® RANGES 36-INCH DUAL-FUEL

PRD366JGU



PROFESSIONAL

PRD366JGU

Dual-Fuel Commercial-Depth Range,
Porcelain Cooktop Surface

SPECIFICATIONS

Total Number of Cooktop Burners	6
Product Width	35 15/16"
Product Height	35 7/8"–36 3/4"
Product Depth	28 1/2"
Overall Oven Capacity* (cu. ft.)	5.7
Overall Oven Interior Dimensions (W x H x D)	28" x 16" x 22"
Usable Oven Interior Dimensions (W x H x D)	25 1/2" x 11 3/4" x 19 5/8"
Cutout Width	36"
Cutout Height	35 7/8"–36 3/4"
Cutout Depth	24"–25 1/8"
Cooktop Surface	Porcelain
Gas Cooktop Burners	1 @ 22,000 BTU / 5 @ 18,000 BTU (NG)
Oven Bake (Watts)	2,400
Oven Broil (Watts)	4,000
Convection (Watts)	2,750
Total Gas Connection Rating	112,000 BTU (NG)
LP Convertible	Included
Electrical Supply	240/208V AC, 60 Hz
Required Circuit Breaker	35 Amp
Power Cord	Purchase Separately
Shipping Weight (lbs.)	420

*According to AHAM Standards

PRD366JGU

INNOVATION

- ★ - Patented Pedestal Star® Burner with QuickClean Base® designed for easy surface cleaning and superior heat spread for any size pan
- ★ - Powerful 22,000 BTU (NG) burner (front right)
- ★ - Precision simmering capabilities as low as 100°F (375 BTU) with 4 ExtraLow® Simmer burners
- ★ - SoftClose® hinges for ultra smooth closing of the oven door
- ★ - Superfast 2-hour self-clean mode – fastest in the industry

PERFORMANCE

- 18,000 BTU (NG) Star® Burners
- Electronic oven display interfaces to cook timer, meat probe and preheat status with audible alert
- Powerful, 8-pass bake and broil elements
- Third Element Convection offers precise airflow for cooking on multiple levels without flavor transfer
- Large oven 5.7 cu. ft. – accommodates commercial sheet pan
- Full Access® telescopic racks, integrated easy-grip handle
- Six rack levels for multiple item cooking
- Star-K certified

DESIGN

- Bold Professional design
- Pinhole and panel lighting concepts provide functional and stylish aesthetics
- Restaurant style metal knobs
- Professional style, continuous cast iron grates
- Continuous porcelain, easy-to-clean cooking surface
- Large oven door window for maximum viewing
- Powerful halogen lighting illuminates the oven cavity
- Hidden bake element makes cleanup one smooth surface
- Signature blue indicator lighting

★ THERMADOR EXCLUSIVE

ACCESSORIES

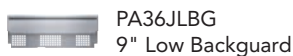

PA36JLBG
9" Low Backguard



PAGRIDDLE
Griddle



PA12CHPBLK
12" Cutting Board



PA36JHSG
22" High Shelf



PWOKRINGHC
Wok Ring



PAKNOBLUJG
Blue Knob Kit



PA36JTKG
Toekick

IMPORTANT NOTE: A 9" Low Backguard, 22" High Shelf or Island Trim is required for installation.

INSTALLATION OPTIONS

Thermador Pro Grand® Ranges feature a bold, professional design and a commercial-depth of 27-inches. These ranges can be installed in a wall or island installation.

BACKGUARDS

When using the Flush Island Trim, Thermador recommends a minimum 12" (305 mm) rear clearance to a combustible surface (see Figure 1, Cabinet Clearances). Clearances from non-combustible materials are not part of the ANSI Z21.1 scope and are not certified by CSA. Clearances of less than 12" (305 mm) must be approved by the local codes and / or by the local authority having jurisdiction.

NATURAL GAS OR LP

Thermador Dual-Fuel Pro Grand Ranges are shipped by the factory to operate on natural gas. They must be converted for use with propane. Verify that the type of gas being used at the installation site matches the type of gas used by the appliance. If the location / job site requires conversion from natural gas to propane (LP), utilize the included LP kit. Field conversion must be done by qualified service personnel only. Please refer to the LP Conversion Instructions for further information.

IMPORTANT

We strongly recommend that a Thermador Professional® Wall or Island Hood or Custom Insert be installed with all Thermador Pro Grand Ranges. Downdraft ventilation should not be used. Do not install a microwave-hood combination above the cooktop, as these types of units do not provide the proper ventilation and are not suitable for use with Thermador Pro Grand Ranges. Refer to the Ventilation section or www.Thermador.com for a complete selection of Professional ventilation options, blowers, and accessories.

Due to the 27-inch commercial-depth of Pro Grand Ranges, the PH Professional Series Wall Hoods or Professional Series Custom Inserts would provide the appropriate depth from the wall to correspond to these ranges.

HIGH ALTITUDE

A high altitude kit is available through Customer Services as service part number 746376.

36-INCH CUTOUT AND RANGE DIMENSIONS

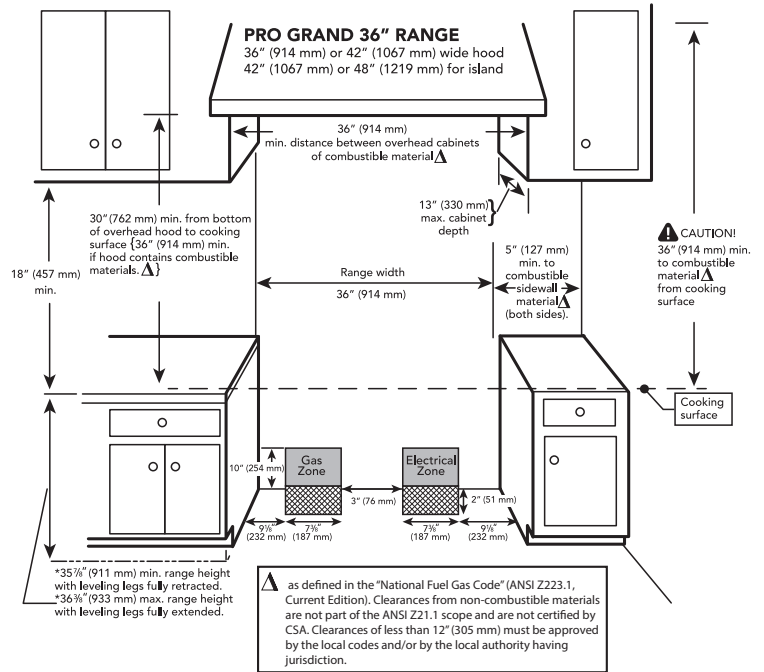

NOTE: A 36-inch minimum clearance is required between the top of the cooking surface and the bottom of an unprotected cabinet. A 30-inch clearance can be used when the bottom of the wood or metal cabinet is protected by not less than 1/4 inch of a flame retardant material covered with not less than No. 28 MSG sheet steel, 0.015 inch (0.4 mm) thick stainless steel, 0.024 inch (0.6 mm) aluminum, or 0.020 inch (0.5 mm) thick copper.

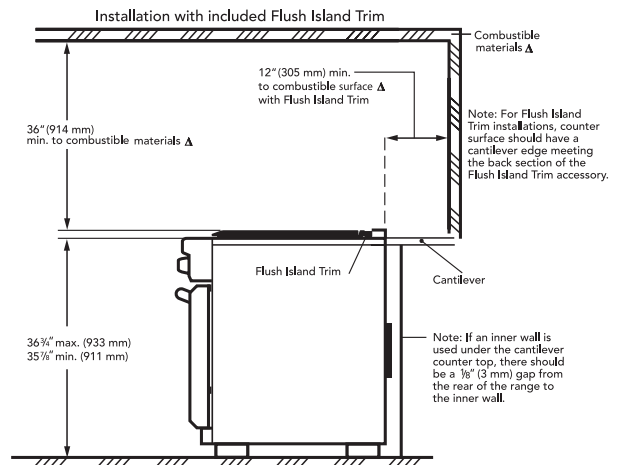
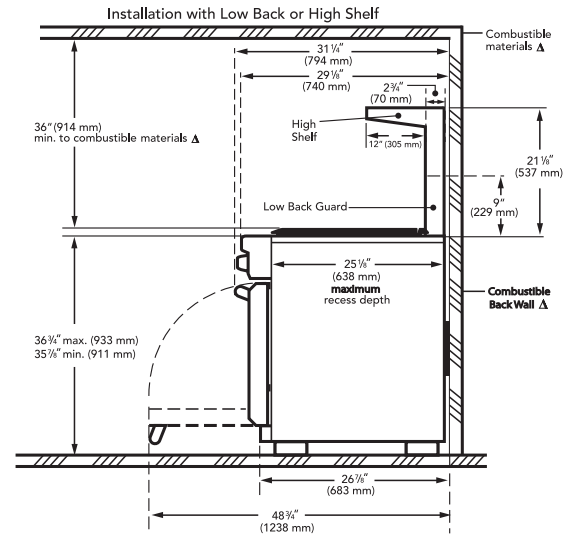

PRO GRAND® RANGES 36-INCH DUAL-FUEL

PRD364JDGU



PROFESSIONAL

PRD364JDGU

Dual-Fuel Commercial-Depth Range,
Porcelain Cooktop Surface

SPECIFICATIONS

Total Number of Cooktop Burners	4
Product Width	35 15/16"
Product Height	35 7/8" – 36 3/4"
Product Depth	28 1/2"
Overall Oven Capacity* (cu. ft.)	5.7
Overall Oven Interior Dimensions (W x H x D)	28" x 16" x 22"
Usable Oven Interior Dimensions (W x H x D)	25 1/2" x 11 3/4" x 19 5/8"
Cutout Width	36"
Cutout Height	35 7/8" – 36 3/4"
Cutout Depth	24" – 25 1/8"
Cooktop Surface	Porcelain
Gas Cooktop Burners	1 @ 22,000 BTU / 3 @ 18,000 BTU (NG)
Oven Bake (Watts)	2,400
Oven Broil (Watts)	4,000
Convection (Watts)	2,750
Total Gas Connection Rating	76,000 BTU (NG)
LP Convertible	Included
Electrical Supply	240/208V AC, 60 Hz
Required Circuit Breaker	35 Amp
Power Cord	Purchase Separately
Shipping Weight (lbs.)	420

*According to AHAM Standards

PRD364JDGU

INNOVATION

- ★ - Patented Pedestal Star® Burner with QuickClean Base® designed for easy surface cleaning and superior heat spread for any size pan
- ★ - Powerful 22,000 BTU (NG) burner (front right)
- ★ - Precision simmering capabilities as low as 100°F (375 BTU) with 4 ExtraLow® Simmer burners
- ★ - SoftClose® hinges for ultra smooth closing of the oven door
- ★ - Superfast 2-hour self-clean mode – fastest in the industry

PERFORMANCE

- 18,000 BTU (NG) Star® Burners
- Non-stick, rust-proof cast-aluminum griddle and grill with fusion coated surface, removable for easy cleanup
- Electronic oven display interfaces to cook timer, meat probe and preheat status with audible alert
- Powerful, 8-pass bake and broil elements
- Third Element Convection offers precise airflow for cooking on multiple levels without flavor transfer
- Large oven 5.7 cu. ft. – accommodates commercial sheet pan
- Full Access® telescopic racks, integrated easy-grip handle
- Six rack levels for multiple item cooking
- Star-K certified

DESIGN

- Bold Professional design
- Pinhole and panel lighting concepts provide functional and stylish aesthetics
- Restaurant style metal knobs
- Professional style, continuous cast iron grates
- Continuous porcelain, easy-to-clean cooking surface
- Large oven door window for maximum viewing
- Powerful halogen lighting illuminates the oven cavity
- Hidden bake element makes cleanup one smooth surface
- Signature blue indicator lighting

★ THERMADOR EXCLUSIVE

ACCESSORIES

 PA36JLBG 9" Low Backguard	 PA12GRILLN Grill	 PWOKRINGHC Wok Ring	 PA12CHPBLK 12" Cutting Board
 PA36JHSG 22" High Shelf	 PAGRIDDLE Griddle	 PAKNOBLUJG Blue Knob Kit	
 PA36JTKG Toekick	 PA12CVRJ 12" Griddle / Grill Cover		

IMPORTANT NOTE: A 9" Low Backguard, 22" High Shelf or Island Trim is required for installation.

PRO GRAND® RANGES 36-INCH DUAL-FUEL

PRD364JDGU

INSTALLATION OPTIONS

Thermador Pro Grand® Ranges feature a bold, professional design and a commercial-depth of 27-inches. These ranges can be installed in a wall or island installation.

BACKGUARDS

When using the Flush Island Trim, Thermador recommends a minimum 12" (305 mm) rear clearance to a combustible surface (see Figure 1, Cabinet Clearances). Clearances from non-combustible materials are not part of the ANSI Z21.1 scope and are not certified by CSA. Clearances of less than 12" (305 mm) must be approved by the local codes and / or by the local authority having jurisdiction.

NATURAL GAS OR LP

Thermador Dual-Fuel Pro Grand Ranges are shipped by the factory to operate on natural gas. They must be converted for use with propane. Verify that the type of gas being used at the installation site matches the type of gas used by the appliance. If the location / job site requires conversion from natural gas to propane (LP), utilize the included LP kit. Field conversion must be done by qualified service personnel only. Please refer to the LP Conversion Instructions for further information.

IMPORTANT

We strongly recommend that a Thermador Professional® Wall or Island Hood or Custom Insert be installed with all Thermador Pro Grand Ranges. Downdraft ventilation should not be used. Do not install a microwave-hood combination above the cooktop, as these types of units do not provide the proper ventilation and are not suitable for use with Thermador Pro Grand Ranges. Refer to the Ventilation section or www.Thermador.com for a complete selection of Professional ventilation options, blowers, and accessories.

Due to the 27-inch commercial-depth of Pro Grand Ranges, the PH Professional Series Wall Hoods or Professional Series Custom Inserts would provide the appropriate depth from the wall to correspond to these ranges.

HIGH ALTITUDE

A high altitude kit is available through Customer Services as service part number 746376.

36-INCH CUTOUT AND RANGE DIMENSIONS

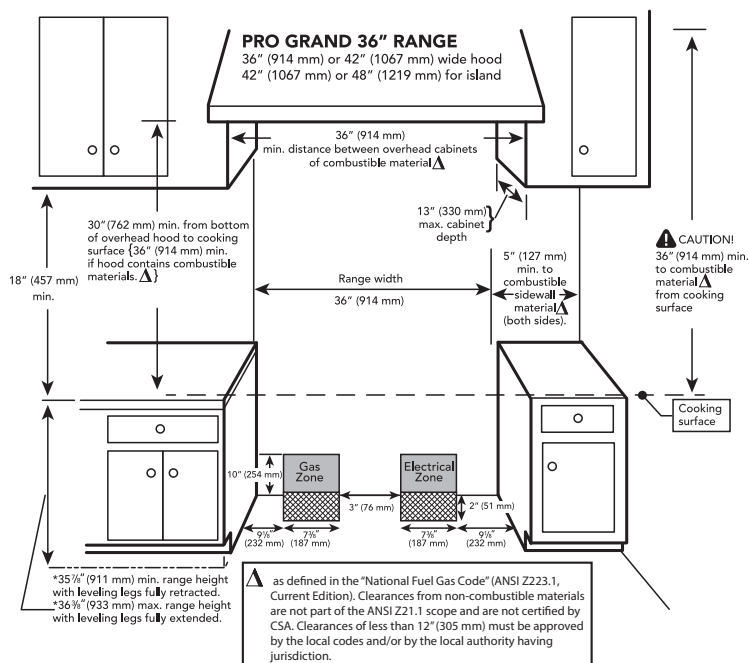

NOTE: A 36-inch minimum clearance is required between the top of the cooking surface and the bottom of an unprotected cabinet. A 30-inch clearance can be used when the bottom of the wood or metal cabinet is protected by not less than 1/4 inch of a flame retardant material covered with not less than No. 28 MSG sheet steel, 0.015 inch (0.4 mm) thick stainless steel, 0.024 inch (0.6 mm) aluminum, or 0.020 inch (0.5 mm) thick copper.

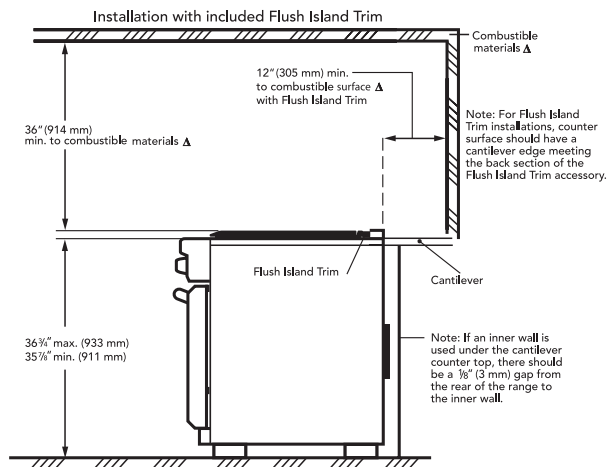
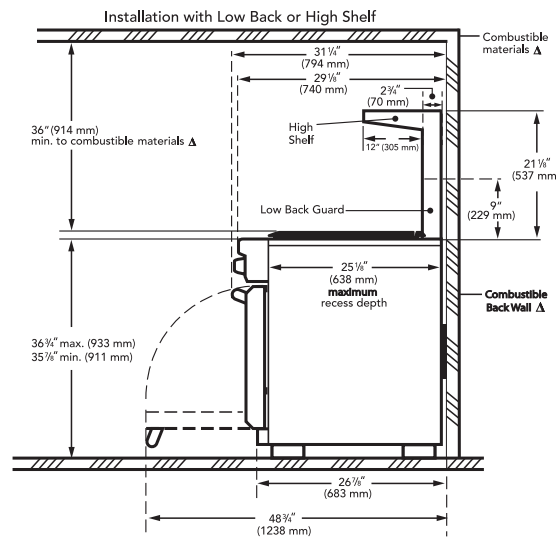

PRO GRAND® RANGES 48-INCH DUAL-FUEL

PRD486JDGU



PROFESSIONAL

PRD486JDGU

Dual-Fuel Commercial-Depth Range,
Porcelain Cooktop Surface

SPECIFICATIONS

Total Number of Cooktop Burners	6
Product Width	47 15/16"
Product Height	36 3/4"
Product Depth	28 1/2"
Overall Oven Capacity* (cu. ft.)	5.7 / 2.5
Overall Oven Interior Dimensions (W x H x D)	28" x 16" x 22" (Lg) 12 3/8" x 16" x 22" (Sm)
Usable Oven Interior Dimensions (W x H x D)	25 1/2" x 11 3/4" x 19 5/8" (Lg) 9 7/8" x 11 3/4" x 19 5/8" (Sm)
Cutout Width	48"
Cutout Height	35 7/8"–36 3/4"
Cutout Depth	24"–25 1/8"
Cooktop Surface	Porcelain
Gas Cooktop Burners	1 @ 22,000 BTU / 5 @ 18,000 BTU (NG)
12" Center Electric Griddle	6-pass, 1,630 Watts
Oven Bake (Watts)	2,400 (Lg) / 2,250 (Sm)
Oven Broil (Watts)	4,000 (Lg) / 3,600 (Sm)
Convection (Watts)	2,750 (Lg) / 1,800 (Sm) 2,750 (Lg) / 1,800 (Sm)
Total Gas Connection Rating	112,000 BTU (NG)
LP Convertible	Included
Electrical Supply	240/208V AC, 60 Hz
Required Circuit Breaker	50 Amp
Power Cord	Purchase Separately
Shipping Weight (lbs.)	590

*According to AHAM Standards

PRD486JDGU

INNOVATION

- ★ - Patented Pedestal Star® Burner with QuickClean Base® designed for easy surface cleaning and superior heat spread for any size pan
- ★ - Powerful 22,000 BTU (NG) burner (front right)
- ★ - Precision simmering capabilities as low as 100°F (375 BTU) with 4 ExtraLow® Simmer burners
- ★ - SoftClose® hinges for ultra smooth closing of the oven door
- ★ - Cleans both ovens simultaneously in just 2 hours

PERFORMANCE

- 18,000 BTU (NG) Star® Burners
- Non-stick, rust-proof cast-aluminum griddle and grill with fusion coated surface, removable for easy cleanup
- Electronic oven display interfaces to cook timer, meat probe and preheat status with audible alert
- Full featured small oven with convection, broil, self clean and meat probe
- Powerful, 8-pass bake and broil elements in large oven and 6-pass elements in small oven
- Third Element Convection offers precise airflow for cooking on multiple levels without flavor transfer
- Large oven 5.7 cu. ft. –accommodates commercial sheet pan plus 2.5 cu. ft. in small oven
- Full Access® telescopic racks, integrated easy-grip handle
- Six rack levels in each oven for multiple item cooking
- Star-K certified

DESIGN

- Bold Professional design
- Pinhole and panel lighting concepts provide functional and stylish aesthetics
- Restaurant style metal knobs
- Professional style, continuous cast iron grates
- Continuous porcelain, easy-to-clean cooking surface
- Hidden bake element makes cleanup one smooth surface
- Large oven door window for maximum viewing
- Powerful halogen lighting illuminates the oven cavity
- Signature blue indicator lighting

★ THERMADOR EXCLUSIVE

ACCESSORIES



PA48JLBG
9" Low Backguard



PA12GRILLN
Grill



PWOKRINGHC
Wok Ring



PA12CHPBLK
12" Cutting Board



PA48JHSG
22" High Shelf



PAGRIDDLE
Griddle



PAKNOBLUJG
Blue Knob Kit



PA48JTKG
Toekick



PA12CVRJ
12" Griddle /
Grill Cover

IMPORTANT NOTE: A 9" Low Backguard, 22" High Shelf or Island Trim is required for installation.

INSTALLATION OPTIONS

Thermador Pro Grand® Ranges feature a bold, professional design and a commercial-depth of 27-inches. These ranges can be installed in a wall or island installation.

BACKGUARDS

When using the Flush Island Trim, Thermador recommends a minimum 12" (305 mm) rear clearance to a combustible surface (see Figure 1, Cabinet Clearances). Clearances from non-combustible materials are not part of the ANSI Z21.1 scope and are not certified by CSA. Clearances of less than 12" (305 mm) must be approved by the local codes and / or by the local authority having jurisdiction.

NATURAL GAS OR LP

Thermador Dual-Fuel Pro Grand Ranges are shipped by the factory to operate on natural gas. They must be converted for use with propane. Verify that the type of gas being used at the installation site matches the type of gas used by the appliance. If the location / job site requires conversion from natural gas to propane (LP), utilize the included LP kit. Field conversion must be done by qualified service personnel only. Please refer to the LP Conversion Instructions for further information.

IMPORTANT

We strongly recommend that a Thermador Professional® Wall or Island Hood or Custom Insert be installed with all Thermador Pro Grand Ranges. Downdraft ventilation should not be used. Do not install a microwave-hood combination above the cooktop, as these types of units do not provide the proper ventilation and are not suitable for use with Thermador Pro Grand Ranges. Refer to the Ventilation section or www.Thermador.com for a complete selection of Professional ventilation options, blowers, and accessories.

Due to the 27-inch commercial-depth of Pro Grand Ranges, the PH Professional Series Wall Hoods or Professional Series Custom Inserts would provide the appropriate depth from the wall to correspond to these ranges.

HIGH ALTITUDE

A high altitude kit is available through Customer Services as service part number 746376.

48-INCH CUTOUT AND RANGE DIMENSIONS

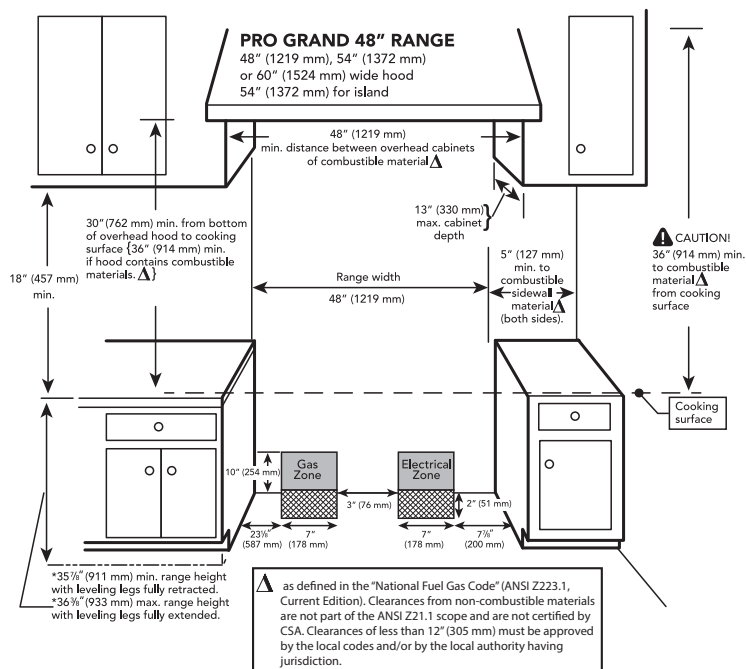

NOTE: A 36-inch minimum clearance is required between the top of the cooking surface and the bottom of an unprotected cabinet. A 30-inch clearance can be used when the bottom of the wood or metal cabinet is protected by not less than 1/4 inch of a flame retardant material covered with not less than No. 28 MSG sheet steel, 0.015 inch (0.4 mm) thick stainless steel, 0.024 inch (0.6 mm) aluminum, or 0.020 inch (0.5 mm) thick copper.

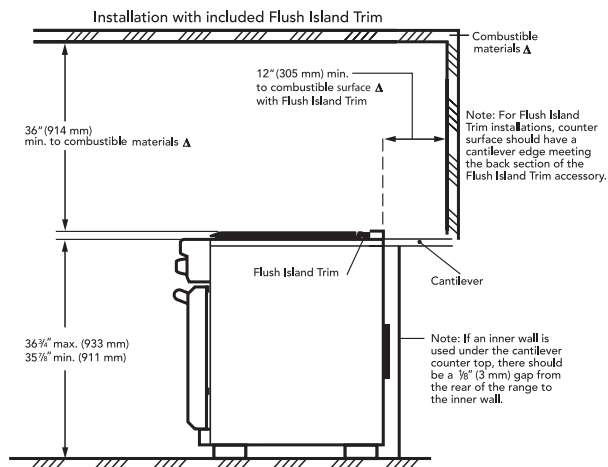
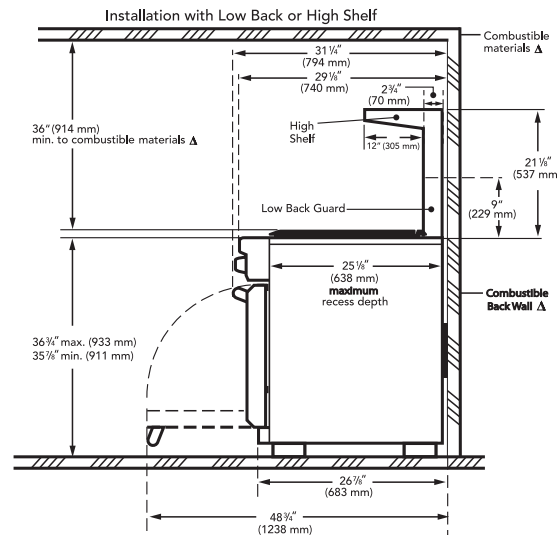

PRO GRAND® STEAM RANGES 48-INCH DUAL-FUEL STEAM

PRD48JDSGU



PROFESSIONAL

PRD48JDSGU

Dual-Fuel Commercial-Depth Steam Range,
Porcelain Cooktop Surface

SPECIFICATIONS

Total Number of Cooktop Burners	6
Product Width	47 15/16"
Product Height	35 7/8"–36 3/4"
Product Depth	28 1/2"
Overall Oven Capacity* (cu. ft.)	5.1 / 1.4
Overall Oven Interior Dimensions (W x H x D)	25" X 16" X 22" (Lg) 14 3/8" X 10 1/2" X 15 7/8" (Sm)
Usable Oven Interior Dimensions (W x H x D)	25 1/2" x 11 3/4" x 19 5/8" (Lg) 12" x 7 3/4" x 15 5/8" (Sm)
Warming Drawer Interior Capacity (cu. ft.)	1.1
Overall Warming Drawer Interior Dimensions (W x H x D)	14 1/8" X 6 3/8" X 20 5/8"
Usable Warming Drawer Capacity Dimensions (W x H x D)	13 3/8" X 4 5/8" X 18 1/2"
Cutout Width	48"
Cutout Height	35 7/8"–36 3/4"
Cutout Depth	24"–25 1/8"
Cooktop Surface	Porcelain
Gas Cooktop Burners	1 @ 22,000 BTU / 5 @ 18,000 BTU (NG)
12" Center Electric Griddle	6-pass, 1,630 Watts
Oven Bake (Watts)	2,400
Oven Broil (Watts)	4,000
Convection (Watts)	2,750 (Lg) / 1,800 (Sm)
Total Gas Connection Rating	112,000 BTU (NG)
LP Convertible	Included
Electrical Supply	240/208V AC, 60 Hz
Required Circuit Breaker	50 Amp
Power Cord	Purchase Separately
Shipping Weight (lbs.)	590

*According to AHAM Standards

PRD48JDSGU

INNOVATION

- ★ - The only professional range on the market with a built-in steam oven and warming drawer
- ★ - 27 easy cook food programs. Pre-programmed modes automatically set the oven temperature and humidity to ensure perfect cooking results
- ★ - Patented Pedestal Star® Burner with QuickClean Base® designed for easy surface cleaning and superior heat spread for any size pan
- ★ - Powerful 22,000 BTU (NG) burner (front right)
- ★ - Precision simmering capabilities as low as 100°F (375 BTU) with 4 ExtraLow® Simmer burners
- ★ - SoftClose® hinges for ultra smooth closing of both ovens and the warming drawer
- ★ - Glass surface warming drawer

PERFORMANCE

- 18,000 BTU (NG) Star® Burners
- Non-stick, rust-proof cast-aluminum griddle and grill with fusion coated surface, removable for easy cleanup
- 1.4 cu. ft. steam cavity easily accommodates a 14 lb. turkey
- Steam oven features 9 advanced conventional cooking modes
- Steam cavity is non-plumbed, for easy installation into any home
- Steam Clean function helps keep the steam oven spotless
- Electronic oven display interfaces to cook timer, meat probe and preheat status with audible alert
- Third Element Convection offers precise airflow for cooking on multiple levels without flavor transfer
- Powerful, 4,000 Watt 8-pass broil elements in large oven
- Full Access® telescopic racks, integrated easy-grip handle
- Spacious 1.1 cu. ft. warming drawer holds up to ten 11" dinner plates
- Drawer has open sides for easy and convenient access
- Star-K certified

DESIGN

- Distinctive three door design showcases Thermador's self-assured bold and elegant design
- Pinhole and panel lighting concepts provide functional and stylish aesthetics
- Professional style, continuous cast iron grates
- Continuous porcelain, easy-to-clean cooking surface
- Hidden bake element makes cleanup one smooth surface
- Large oven door window for maximum viewing

★ THERMADOR EXCLUSIVE

ACCESSORIES

	PA48JLBSG 9" Low Backguard		PA12GRILLN Grill		CS1XLPH Perforated Cooking Pan– Half Size (1 5/8" Deep)		CS2LH Baking Tray
	PA48JHSSG 22" High Shelf		PAGRIDDLE Griddle		CS2XLPH Perforated Cooking Pan– Full Size (1 5/8" Deep)		PAKNOBLUJG Blue Knob Kit
	PA48JTKG Toekick		PA12CVRJ 12" Griddle / Grill Cover		CS2XLH Cooking Pan– Full Size		PA12CHPBLK 12" Cutting Board
	CSRACKH Wire Rack		PWOKRINGHC Wok Ring		CS1XLH Cooking Pan– Half Size		

IMPORTANT NOTE: A 9" Low Backguard, 22" High Shelf or Island Trim is required for installation.

PRO GRAND® STEAM RANGES 48-INCH DUAL-FUEL STEAM

PRD48JDSGU

INSTALLATION OPTIONS

Thermador Pro Grand® Ranges feature a bold, professional design and a commercial-depth of 27-inches. These ranges can be installed in a wall or island installation.

BACKGUARDS

When using the Flush Island Trim, Thermador recommends a minimum 12" (305 mm) rear clearance to a combustible surface (see Figure 1, Cabinet Clearances). Clearances from non-combustible materials are not part of the ANSI Z21.1 scope and are not certified by CSA. Clearances of less than 12" (305 mm) must be approved by the local codes and / or by the local authority having jurisdiction.

NATURAL GAS OR LP

Thermador Dual-Fuel Pro Grand Ranges are shipped by the factory to operate on natural gas. They must be converted for use with propane. Verify that the type of gas being used at the installation site matches the type of gas used by the appliance. If the location / job site requires conversion from natural gas to propane (LP), utilize the included LP kit. Field conversion must be done by qualified service personnel only. Please refer to the LP Conversion Instructions for further information.

IMPORTANT

We strongly recommend that a Thermador Professional® Wall or Island Hood or Custom Insert be installed with all Thermador Pro Grand Ranges. Downdraft ventilation should not be used. Do not install a microwave-hood combination above the cooktop, as these types of units do not provide the proper ventilation and are not suitable for use with Thermador Pro Grand Ranges. Refer to the Ventilation section or www.Thermador.com for a complete selection of Professional ventilation options, blowers, and accessories.

Due to the 27-inch commercial-depth of Pro Grand Ranges, the PH Professional Series Wall Hoods or Professional Series Custom Inserts would provide the appropriate depth from the wall to correspond to these ranges.

HIGH ALTITUDE

A high altitude kit is available through Customer Services as service part number 746376.

48-INCH CUTOUT AND RANGE DIMENSIONS

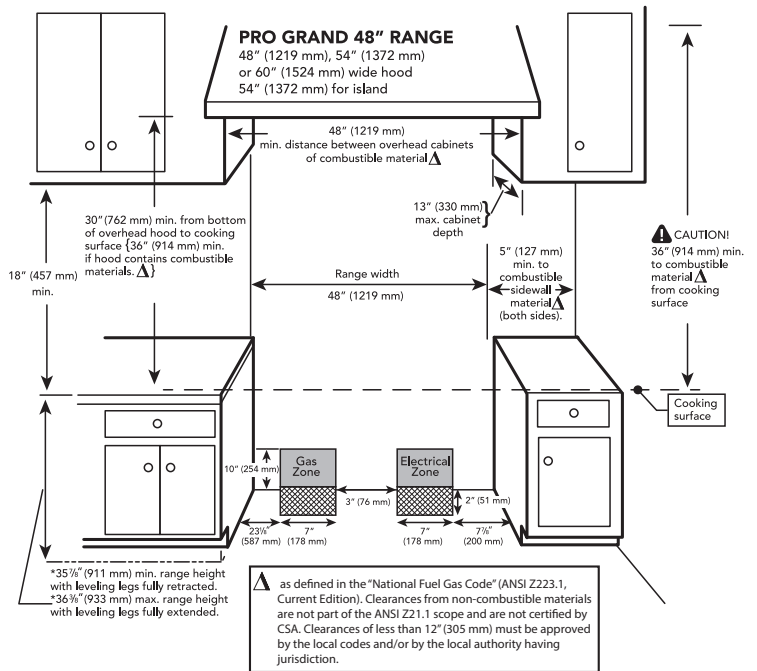

NOTE: A 36-inch minimum clearance is required between the top of the cooking surface and the bottom of an unprotected cabinet. A 30-inch clearance can be used when the bottom of the wood or metal cabinet is protected by not less than 1/4 inch of a flame retardant material covered with not less than No. 28 MSG sheet steel, 0.015 inch (0.4 mm) thick stainless steel, 0.024 inch (0.6 mm) aluminum, or 0.020 inch (0.5 mm) thick copper.

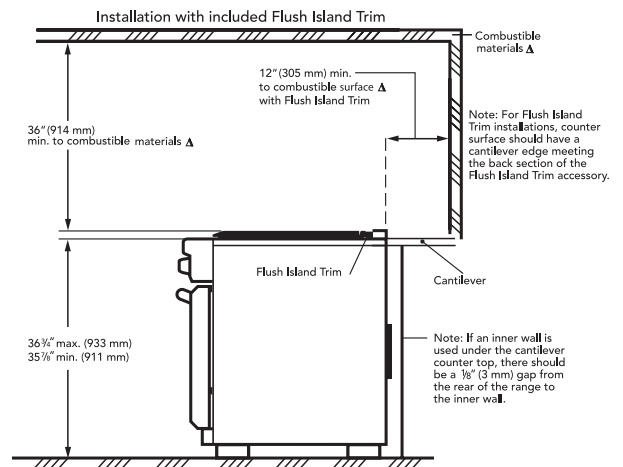
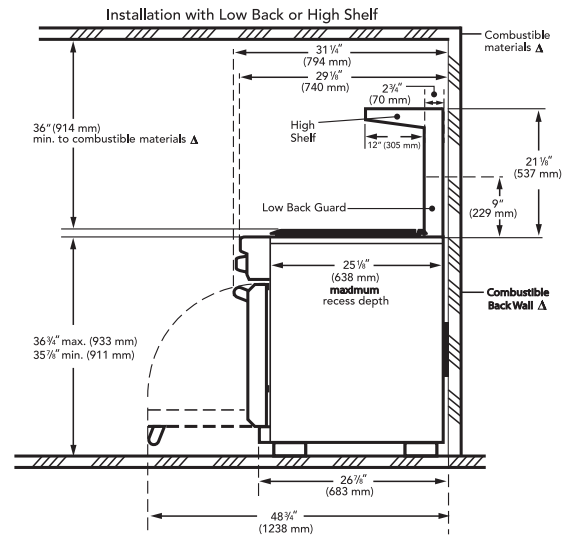

PRO GRAND® RANGES 36-INCH GAS

PRG366JG / PRL366JG



PROFESSIONAL

PRG366JG / PRL366JG

Natural Gas / Liquid Propane (LP) Gas Commercial-Depth Range, Porcelain Cooktop Surface

SPECIFICATIONS

	PRG366JG	PRL366JG
Total Number of Cooktop Burners	6	
Product Width	35 15/16"	
Product Height	35 7/8"–36 3/4"	
Product Depth	28 1/2"	
Overall Oven Capacity* (cu. ft.)	5.5	
Overall Oven Interior Dimensions (W x H x D)	28" x 15" x 22"	
Usable Oven Interior Dimensions (W x H x D)	25 1/2" x 11 3/4" x 19 5/8"	
Cutout Width	36"	
Cutout Height	35 7/8"–36 3/4"	
Cutout Depth	24"–25 1/8"	
Cooktop Surface	Porcelain	
Gas Cooktop Burners	1 @ 22,000 BTU / 5 @ 18,000 BTU	1 @ 18,000 BTU / 5 @ 15,000 BTU
Oven Bake	17,000 BTU	17,000 BTU
Oven Broil	30,000 BTU	25,000 BTU
Total Gas Connection Rating	142,000 BTU	118,000 BTU
LP Convertible	Order LP or NG	
Electrical Supply	120V AC, 60 Hz	
Required Circuit Breaker	15 Amp	
Power Cord	96", 3-Wire	
Shipping Weight (lbs.)	420	

*According to AHAM Standards

PRG366JG / PRL366JG

INNOVATION

- ★ - Patented Pedestal Star® Burner with QuickClean Base® designed for easy surface cleaning and superior heat spread for any size pan
- ★ - Powerful 22,000 / 18,000 BTU (NG / LP) burner (front right)
- ★ - Precision simmering capabilities as low as 100°F (375 BTU) with 4 ExtraLow® Simmer burners
- ★ - SoftClose® hinges for ultra smooth closing of the oven door
- ★ - Superfast 2-hour self-clean mode – fastest in the industry

PERFORMANCE

- 18,000 BTU (NG) Star® Burners
- Electronic oven display interfaces to cook timer, meat probe and preheat status with audible alert
- Powerful, 30,000 / 25,000 BTU bake and 17,000 BTU broil burners (NG / LP)
- Convection Bake offers precise multi-level baking results
- Large oven 5.5 cu. ft. – accommodates commercial sheet pan
- Full Access® telescopic racks, integrated easy-grip handle
- Six rack levels for multiple item cooking
- Star-K certified

DESIGN

- Bold Professional design
- Pinhole and panel lighting concepts provide functional and stylish aesthetics
- Restaurant style metal knobs
- Professional style, continuous cast iron grates
- Continuous porcelain, easy-to-clean cooking surface
- Large oven door window for maximum viewing
- Powerful halogen lighting illuminates the oven cavity
- Signature blue indicator lighting

★ THERMADOR EXCLUSIVE

ACCESSORIES

 PA36JLBG
9" Low Backguard

 PAGRIDDLE
Griddle

 PAKNOBLUJG
Blue Knob Kit

 PA12CHPBLK
12" Cutting Board

 PA36JHSG
22" High Shelf

 PWOKRINGHC
Wok Ring

 PA36JTKG
Toekick

IMPORTANT NOTE: A 9" Low Backguard, 22" High Shelf or Island Trim is required for installation.

INSTALLATION OPTIONS

Thermador Pro Grand® Ranges feature a bold, professional design and a commercial-depth of 27-inches. These ranges can be installed in a wall or island installation.

BACKGUARDS

When using the Flush Island Trim, Thermador recommends a minimum 12" (305 mm) rear clearance to a combustible surface (see Figure 1, Cabinet Clearances). Clearances from non-combustible materials are not part of the ANSI Z21.1 scope and are not certified by CSA. Clearances of less than 12" (305 mm) must be approved by the local codes and / or by the local authority having jurisdiction.

NATURAL GAS OR LP

Thermador All-Gas Pro Grand Ranges are shipped by the factory to operate on natural gas. They must be converted for use with propane. Verify that the type of gas being used at the installation site matches the type of gas used by the appliance. If the location / job site requires conversion from natural gas to propane (LP), utilize the included LP kit. Field conversion must be done by qualified service personnel only. Please refer to the LP Conversion Instructions for further information.

IMPORTANT

We strongly recommend that a Thermador Professional® Wall or Island Hood or Custom Insert be installed with all Thermador Pro Grand Ranges. Downdraft ventilation should not be used. Do not install a microwave-hood combination above the cooktop, as these types of units do not provide the proper ventilation and are not suitable for use with Thermador Pro Grand Ranges. Refer to the Ventilation section or www.Thermador.com for a complete selection of Professional ventilation options, blowers, and accessories.

Due to the 27-inch commercial-depth of Pro Grand Ranges, the PH Professional Series Wall Hoods or Professional Series Custom Inserts would provide the appropriate depth from the wall to correspond to these ranges.

36-INCH CUTOUT AND RANGE DIMENSIONS

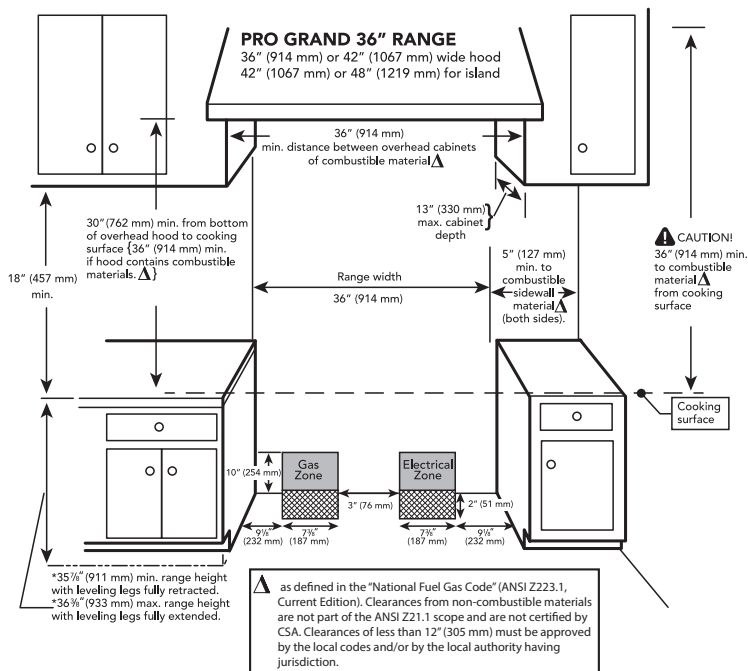

NOTE: A 36-inch minimum clearance is required between the top of the cooking surface and the bottom of an unprotected cabinet. A 30-inch clearance can be used when the bottom of the wood or metal cabinet is protected by not less than 1/4 inch of a flame retardant material covered with not less than No. 28 MSG sheet steel, 0.015 inch (0.4 mm) thick stainless steel, 0.024 inch (0.6 mm) aluminum, or 0.020 inch (0.5 mm) thick copper.

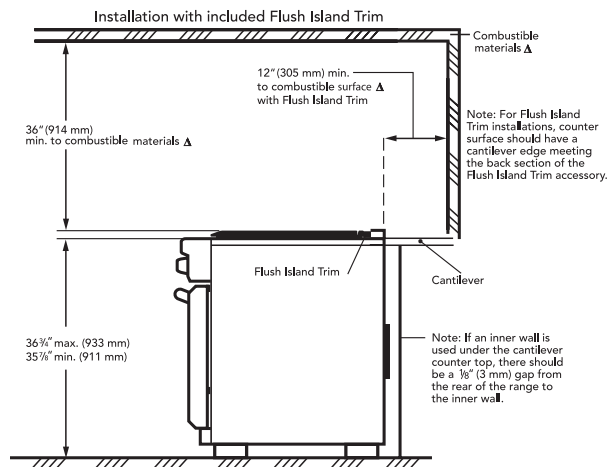
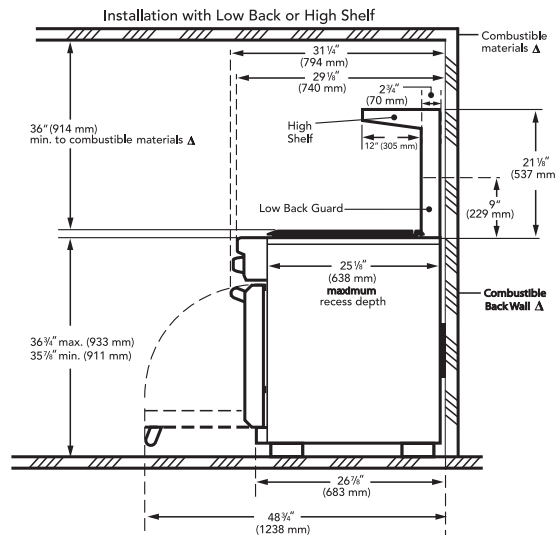

PRO GRAND® RANGES

36-INCH GAS

PRG364JDG / PRL364JDG



PROFESSIONAL

PRG364JDG / PRL364JDG

Natural Gas / Liquid Propane (LP) Gas Commercial-Depth Range, Porcelain Cooktop Surface

SPECIFICATIONS

	PRG364JDG	PRL364JDG
Total Number of Cooktop Burners	4	
Product Width	35 15/16"	
Product Height	35 7/8" – 36 3/4"	
Product Depth	28 1/2"	
Overall Oven Capacity* (cu. ft.)	5.5	
Overall Oven Interior Dimensions (W x H x D)	28" x 15" x 22"	
Usable Oven Interior Dimensions (W x H x D)	28 1/2" x 11 3/4" x 19 5/8"	
Cutout Width	36"	
Cutout Height	35 7/8" – 36 3/4"	
Cutout Depth	24" – 25 1/8"	
Cooktop Surface	Porcelain	
Gas Cooktop Burners	1 @ 22,000 BTU / 3 @ 18,000 BTU	1 @ 18,000 BTU / 3 @ 15,000 BTU
12" Center Electric Griddle	6-pass, 1,630 Watts	
Oven Bake	17,000 BTU	17,000 BTU
Oven Broil	30,000 BTU	25,000 BTU
Total Gas Connection Rating	106,000 BTU	88,000 BTU
LP Convertible	Order LP or NG	
Electrical Supply	120V AC, 60 Hz	
Required Circuit Breaker	20 Amp	
Power Cord	96", 3-Wire	
Shipping Weight (lbs.)	420	

*According to AHAM Standards

PRG364JDG / PRL364JDG

INNOVATION

- ★ - Patented Pedestal Star® Burner with QuickClean Base® designed for easy surface cleaning and superior heat spread for any size pan
- ★ - Powerful 22,000 / 18,000 BTU (NG / LP) burner (front right)
- ★ - Precision simmering capabilities as low as 100°F (375 BTU) with 4 ExtraLow® Simmer burners
- ★ - SoftClose® hinges for ultra smooth closing of the oven door
- ★ - Superfast 2-hour self-clean mode – fastest in the industry

PERFORMANCE

- 18,000 / 15,000 BTU (NG / LP) Star® Burners
- Non-stick, rust-proof cast-aluminum griddle and grill with fusion coated surface, removable for easy cleanup
- Electronic oven display interfaces to cook timer, meat probe and preheat status with audible alert
- Powerful, 30,000 / 25,000 BTU bake and 17,000 BTU broil burners (NG / LP)
- Convection Bake offers precise multi-level baking results
- Large oven 5.5 cu. ft. – accommodates commercial sheet pan
- Full Access® telescopic racks, integrated easy-grip handle
- Six rack levels for multiple item cooking
- Star-K certified

DESIGN

- Bold Professional design
- Pinhole and panel lighting concepts provide functional and stylish aesthetics
- Restaurant style metal knobs
- Professional style, continuous cast iron grates
- Continuous porcelain, easy-to-clean cooking surface
- Large oven door window for maximum viewing
- Powerful halogen lighting illuminates the oven cavity
- Signature blue indicator lighting

★ THERMADOR EXCLUSIVE

ACCESSORIES

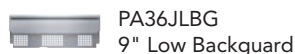

PA36JLBG
9" Low Backguard

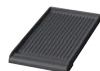

PA12GRILLN
Grill



PWOKRINGHC
Wok Ring



PA12CHPBLK
12" Cutting Board



PA36JHSG
22" High Shelf



PAGRIDDLE
Griddle



PAKNOBLUJG
Blue Knob Kit



PA36JTKG
Toekick



PA12CVRJ
12" Griddle /
Grill Cover

IMPORTANT NOTE: A 9" Low Backguard, 22" High Shelf or Island Trim is required for installation.

INSTALLATION OPTIONS

Thermador Pro Grand® Ranges feature a bold, professional design and a commercial-depth of 27-inches. These ranges can be installed in a wall or island installation.

BACKGUARDS

When using the Flush Island Trim, Thermador recommends a minimum 12" (305 mm) rear clearance to a combustible surface (see Figure 1, Cabinet Clearances). Clearances from non-combustible materials are not part of the ANSI Z21.1 scope and are not certified by CSA. Clearances of less than 12" (305 mm) must be approved by the local codes and / or by the local authority having jurisdiction.

NATURAL GAS OR LP

Thermador All-Gas Pro Grand Ranges are shipped by the factory to operate on natural gas. They must be converted for use with propane. Verify that the type of gas being used at the installation site matches the type of gas used by the appliance. If the location / job site requires conversion from natural gas to propane (LP), utilize the included LP kit. Field conversion must be done by qualified service personnel only. Please refer to the LP Conversion Instructions for further information.

IMPORTANT

We strongly recommend that a Thermador Professional® Wall or Island Hood or Custom Insert be installed with all Thermador Pro Grand Ranges. Downdraft ventilation should not be used. Do not install a microwave-hood combination above the cooktop, as these types of units do not provide the proper ventilation and are not suitable for use with Thermador Pro Grand Ranges. Refer to the Ventilation section or www.Thermador.com for a complete selection of Professional ventilation options, blowers, and accessories.

Due to the 27-inch commercial-depth of Pro Grand Ranges, the PH Professional Series Wall Hoods or Professional Series Custom Inserts would provide the appropriate depth from the wall to correspond to these ranges.

36-INCH CUTOUT AND RANGE DIMENSIONS

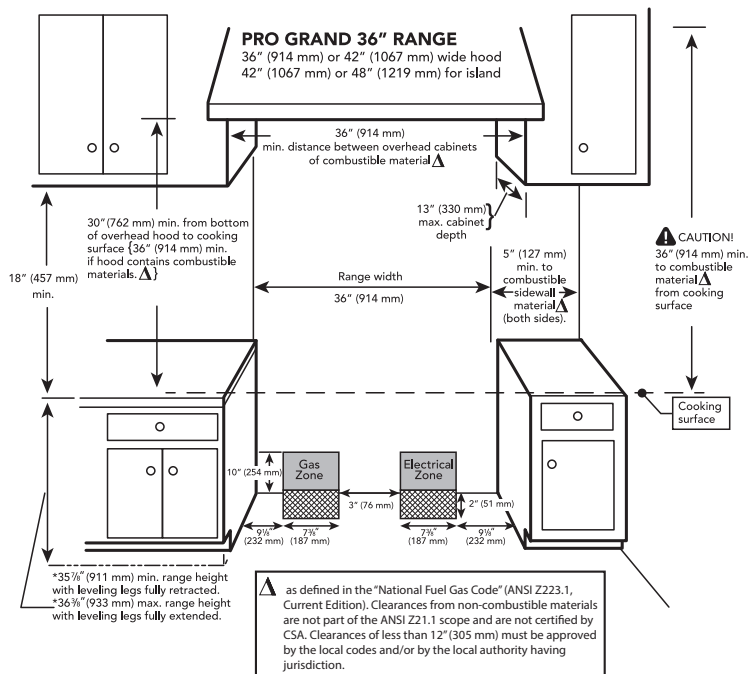

NOTE: A 36-inch minimum clearance is required between the top of the cooking surface and the bottom of an unprotected cabinet. A 30-inch clearance can be used when the bottom of the wood or metal cabinet is protected by not less than 1/4 inch of a flame retardant material covered with not less than No. 28 MSG sheet steel, 0.015 inch (0.4 mm) thick stainless steel, 0.024 inch (0.6 mm) aluminum, or 0.020 inch (0.5 mm) thick copper.

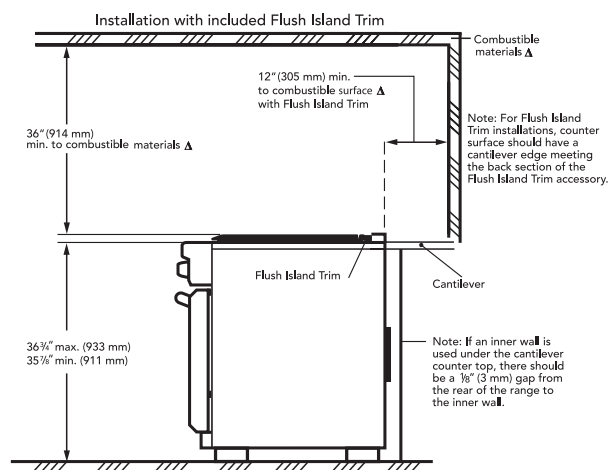
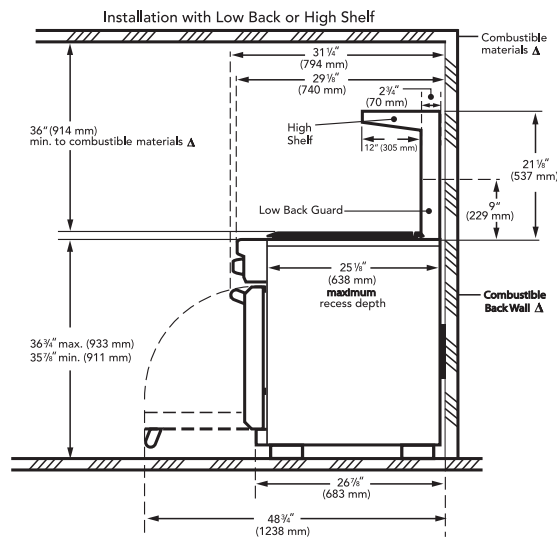

PRO GRAND® RANGES

48-INCH GAS

PRG486JDG / PRL486JDG



PROFESSIONAL

PRG486JDG / PRL486JDG

Natural Gas / Liquid Propane (LP) Gas Commercial-Depth Range, Porcelain Cooktop Surface

SPECIFICATIONS

	PRG486JDG	PRL486JDG
Total Number of Cooktop Burners	6	
Product Width	47 15/16"	
Product Height	35 7/8" – 36 3/4"	
Product Depth	28 1/2"	
Overall Oven Capacity* (cu. ft.)	5.5 / 2.4	
Overall Oven Interior Dimensions (W x H x D)	28" x 15" x 22" (Lg) 12 3/8" x 15" x 22" (Sm)	
Usable Oven Interior Dimensions (W x H x D)	25 1/2" x 11 3/4" x 19 5/8" (Lg) 9 7/8" x 11 3/4" x 19 5/8" (Sm)	
Cutout Width	48"	
Cutout Height	35 7/8" – 36 3/4"	
Cutout Depth	24" – 25 1/8"	
Cooktop Surface	Porcelain	
Gas Cooktop Burners	1 @ 22,000 BTU / 5 @ 18,000 BTU	1 @ 18,000 BTU / 5 @ 15,000 BTU
12" Center Electric Griddle	6-pass, 1,630 Watts	
Oven Bake	17,000 BTU (Lg)	17,000 BTU (Lg)
Oven Broil	30,000 BTU (Sm)	25,000 BTU (Sm)
	9,000 BTU (Lg)	9,000 BTU (Lg)
	15,000 BTU (Sm)	14,000 BTU (Sm)
Total Gas Connection Rating	157,000 BTU	132,000 BTU
LP Convertible	Order LP or NG	
Electrical Supply	120V AC, 60 Hz	
Required Circuit Breaker	20 Amp	
Power Cord	96", 3-Wire	
Shipping Weight (lbs.)	590	

*According to AHAM Standards

ACCESSORIES

 PA48JLBG
9" Low Backguard

 PA12GRILLN
Grill

 PWOKRINGHC
Wok Ring

 PA12CHPBLK
12" Cutting Board

 PA48JHSG
22" High Shelf

 PAGRIDDLE
Griddle

 PAKNOBLUJG
Blue Knob Kit

 PA48JTKG
Toekick

 PA12CVRJ
12" Griddle /
Grill Cover

PRG486JDG / PRL486JDG

INNOVATION

- ★ - Patented Pedestal Star® Burner with QuickClean Base® designed for easy surface cleaning and superior heat spread for any size pan
- ★ - Powerful 22,000 / 18,000 BTU (NG / LP) burner (front right)
- ★ - Precision simmering capabilities as low as 100°F (375 BTU) with 4 ExtraLow® Simmer burners
- ★ - SoftClose® hinges for ultra smooth closing of the oven door
- ★ - Superfast 2-hour self clean in both ovens

PERFORMANCE

- 18,000 / 15,000 BTU (NG / LP) Star® Burners
- Non-stick, rust-proof cast-aluminum griddle and grill with fusion coated surface, removable for easy cleanup
- Electronic oven display interfaces to cook timer, meat probe and preheat status with audible alert
- Full featured small oven with convection, broil, self clean and meat probe
- Powerful, 30,000 / 25,000 BTU bake and 17,000 BTU broil burners in the large oven, 15,000 / 14,000 BTU bake and 9,000 broil in the small (NG / LP)
- Convection Bake offers precise multi-level baking results
- Large oven 5.5 cu. ft. – accommodates commercial sheet pan plus 2.4 cu. ft. in small oven
- Full Access® telescopic racks, integrated easy-grip handle
- Six rack levels in each oven for multiple item cooking
- Star-K certified

DESIGN

- Bold Professional design
- Pinhole and panel lighting concepts provide functional and stylish aesthetics
- Restaurant style metal knobs
- Professional style, continuous cast iron grates
- Continuous porcelain, easy-to-clean cooking surface
- Large oven door window for maximum viewing
- Powerful halogen lighting illuminates the oven cavity
- Signature blue indicator lighting

★ THERMADOR EXCLUSIVE

IMPORTANT NOTE: A 9" Low Backguard, 22" High Shelf or Island Trim is required for installation.

INSTALLATION OPTIONS

Thermador Pro Grand® Ranges feature a bold, professional design and a commercial-depth of 27-inches. These ranges can be installed in a wall or island installation.

BACKGUARDS

Thermador Pro Ranges ship with a flush Island Trim. When installing against a combustible surface, a Thermador 22" High Shelf or 9" Low Backguard must be purchased separately. If the range is installed with the Island Trim, a minimum 12" of clearance is required to a combustible surface. The backguard must be attached to the range before sliding it into the final installed position.

NATURAL GAS OR LP

Thermador All-Gas Pro Grand Ranges are shipped by the factory to operate on natural gas. They must be converted for use with propane. Verify that the type of gas being used at the installation site matches the type of gas used by the appliance. If the location / job site requires conversion from natural gas to propane (LP), utilize the included LP kit. Field conversion must be done by qualified service personnel only. Please refer to the LP Conversion Instructions for further information.

IMPORTANT

We strongly recommend that a Thermador Professional® Wall or Island Hood or Custom Insert be installed with all Thermador Pro Grand Ranges. Downdraft ventilation should not be used. Do not install a microwave-hood combination above the cooktop, as these types of units do not provide the proper ventilation and are not suitable for use with Thermador Pro Grand Ranges. Refer to the Ventilation section or www.Thermador.com for a complete selection of Professional ventilation options, blowers, and accessories.

Due to the 27-inch commercial-depth of Pro Grand Ranges, the PH Professional Series Wall Hoods or Professional Series Custom Inserts would provide the appropriate depth from the wall to correspond to these ranges.

48-INCH CUTOUT AND RANGE DIMENSIONS

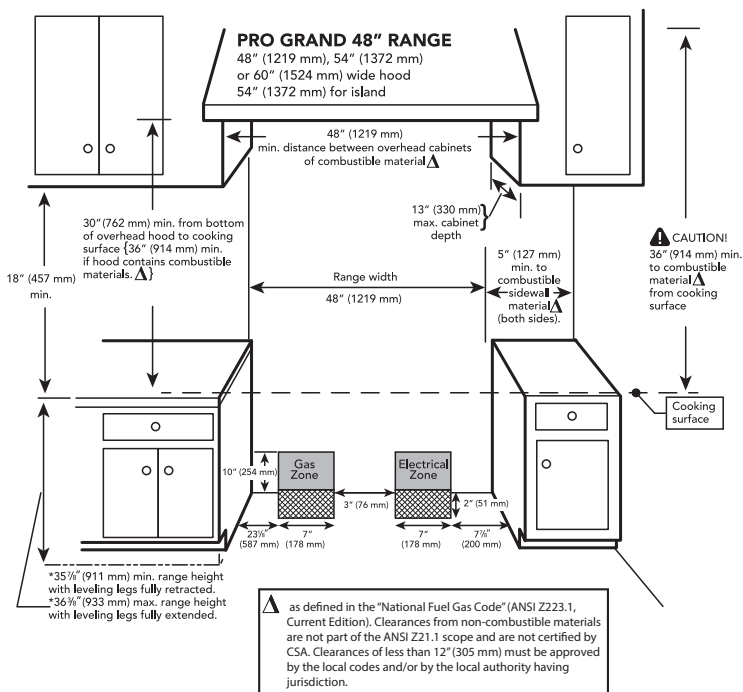

NOTE: A 36-inch minimum clearance is required between the top of the cooking surface and the bottom of an unprotected cabinet. A 30-inch clearance can be used when the bottom of the wood or metal cabinet is protected by not less than 1/4 inch of a flame retardant material covered with not less than No. 28 MSG sheet steel, 0.015 inch (0.4 mm) thick stainless steel, 0.024 inch (0.6 mm) aluminum, or 0.020 inch (0.5 mm) thick copper.

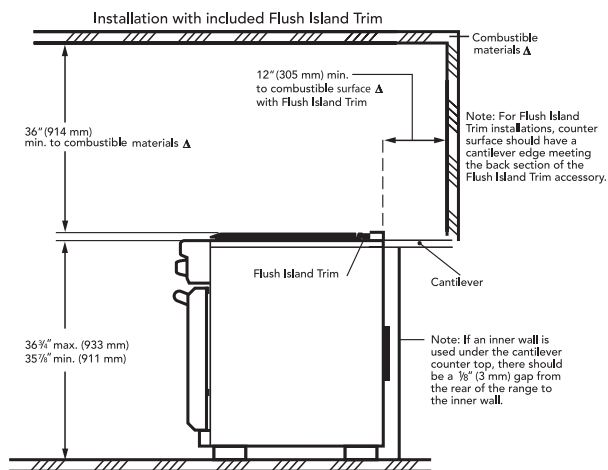
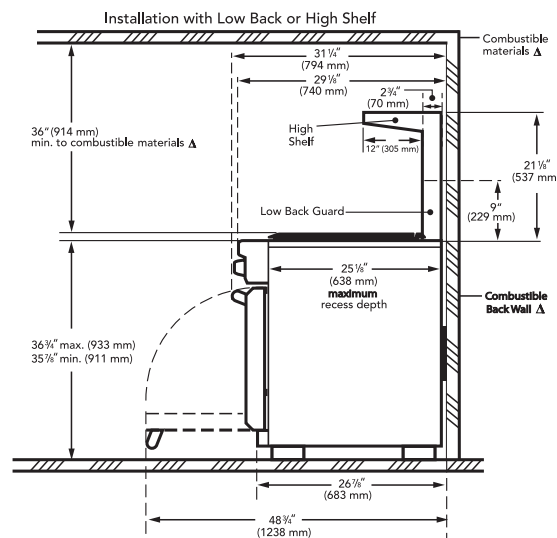

EXPERIENCE THERMADOR®

Thermador is committed to giving you an enjoyable, creative and rewarding cooking experience. Whether you would like to research our products, watch a video of our chef searing the perfect scallop, or have questions on the use and care of your product, simply browse our online resource library at thermador.com

CONNECT WITH US

thermador.com/blog

 [facebook.com](https://www.facebook.com/thermador)

 twitter.com/thermador

 [youtube.com/thermadorhome](https://www.youtube.com/thermadorhome)

 [pinterest.com/thermador](https://www.pinterest.com/thermador)

 [instagram.com/thermadorhome](https://www.instagram.com/thermadorhome)

VISIT THE ABOVE SITES TO SHARE PHOTOS OF
YOUR NEW KITCHEN AND CREATIVE DISHES.

TAKE US WITH YOU

Visit the App Store™ or Google Play™ to download our Innovations app, including the Thermador Kitchen Ideas & Lookbook and the Thermador Kitchen Design and Planning Guide.

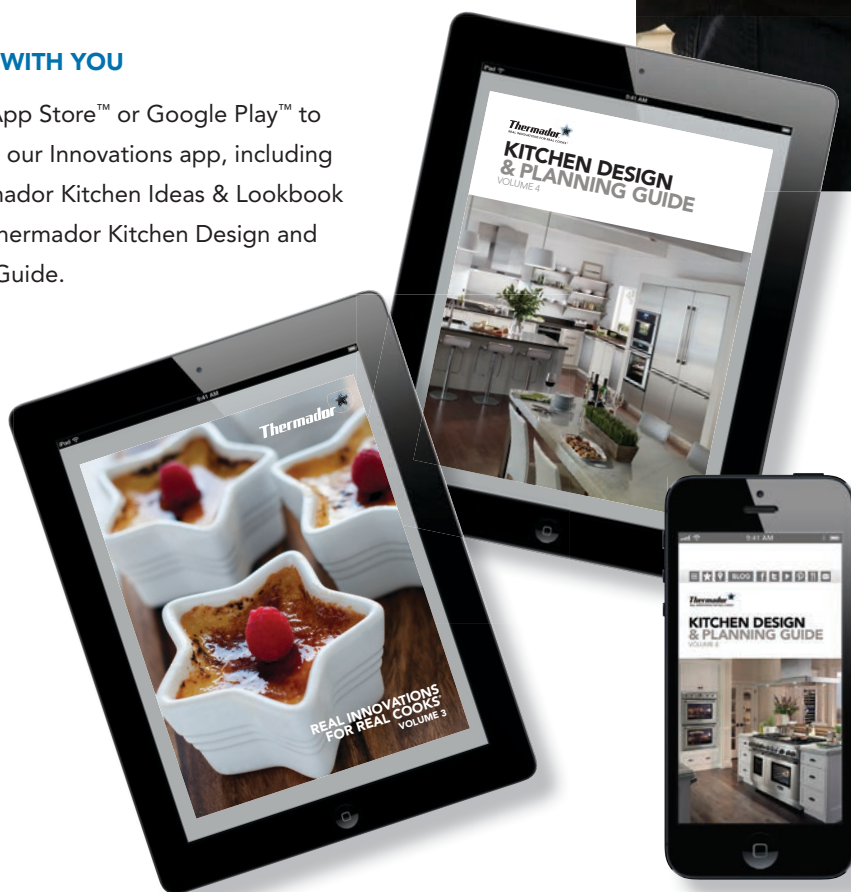

CUSTOMER SERVICE

For dedicated customer service on any Thermador product, please call: 1-800-735-4328 or contact us at thermador.com



1 800 735 4328

USA THERMADOR.COM
CANADA THERMADOR.CA