



1000 CFM Internal Blower
VTN1030N



VTN1030N

- Used with PH Wall Hoods and Pro Custom Inserts
- Internal blower mounted within hood.

825225912750

1000 CFM Internal Blower VTN1030N

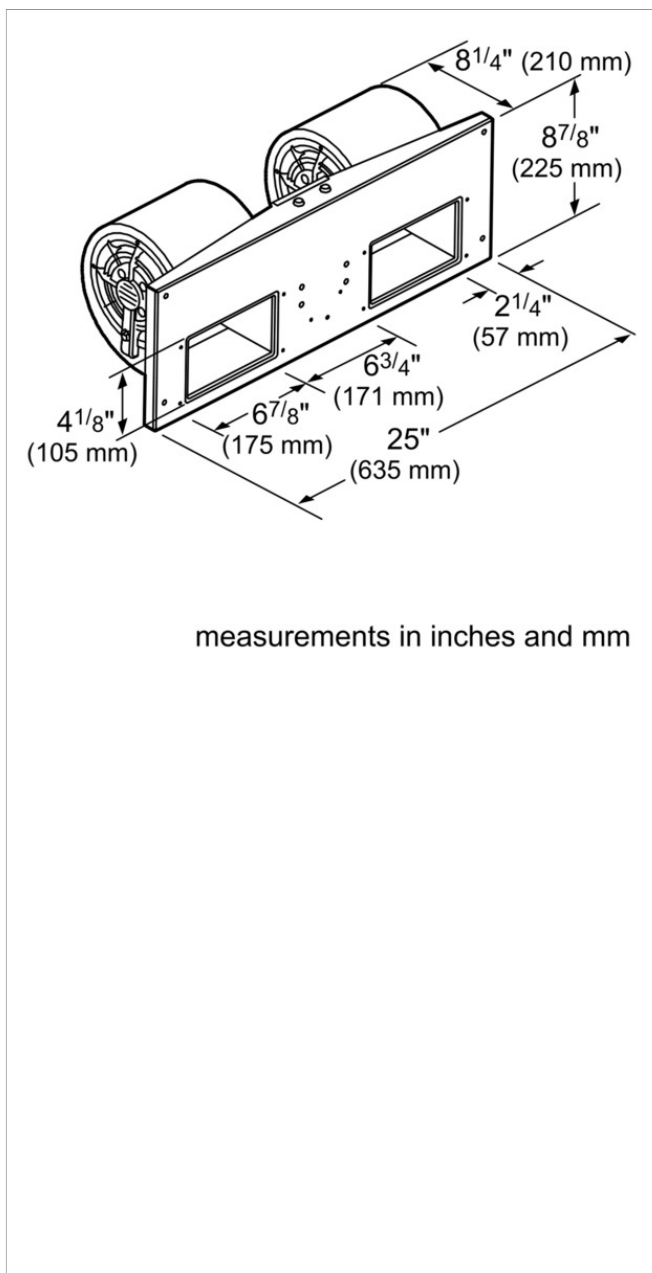

Product Features

Operating Mode: Ducted

Consumption and connection features

UPC code: 825225912750

Material: Stainless steel

Watts (W): 640

Current (A):

Volts (V): 120

Frequency (Hz): 60

Approval certificates: CSA, UL

Power cord length (in):

Power cord length (cm): 150

Plug type: 120V-3 prong

Overall appliance dimensions (HxWxD) (in): 8 1/4" / x 25 1/8" x 8 1/4"

Overall appliance dimensions (HxWxD) (mm): 210 MM x 760 x 210

Product packaging dimensions (HxWxD) (in): 10.62 x 26.37 x 12.99

Adjustable feet:

Height of the chimney (in):

Height of the chimney (mm):

Vertical rise height:

Required distance above cooktop/ranges:

Net weight (lbs): 21

Net weight (kg): 10.0

Gross weight (lbs): 24

Gross weight (kg): 11.0

Motor location: N/A

Maximum CFM: 1000

Diameter of air duct (in) top: 10

Diameter of air duct (in) back:

Discharge direction: vertical

No-return airflow flap: No

2015-03-20