

User's Guide

for Frontload Washers



Original Instructions

Keep These Instructions for Future Reference.

(If this machine changes ownership, this manual must accompany machine.)

FLW1548C_SVG

Front Matter

	WARNING
<p>Failure to install, maintain, and/or operate this machine according to the manufacturer's instructions may result in conditions which can produce bodily injury and/or property damage.</p>	
W030	

	WARNING
<p>For your safety and to reduce the risk of fire or an explosion, do not store or use gasoline or other flammable vapors and liquids in the vicinity of this or any other appliance.</p>	
W022	

NOTE: The **WARNING** and **IMPORTANT** instructions appearing in this manual are not meant to cover all possible conditions and situations that may occur. It must be understood that common sense, caution, and carefulness are factors which cannot be built into these washers. These factors **MUST BE** supplied by the person(s) installing, maintaining, or operating the washer.

Always contact the distributor, service agent, or the manufacturer about any problems or conditions you do not understand.



Read all instructions before using washer.

This product uses FreeRTOS V7.2.0 (www.freertos.org).

Table of Contents

Safety Information.....	5
Explanation of <i>Safety Messages</i>	5
Important Safety Instructions.....	5
Operation.....	7
Before Washing.....	7
Loading the Washer.....	7
Control Panel.....	9
Digital Display.....	9
Cycles.....	9
Selections.....	10
Options.....	10
Status.....	10
To Wash Clothes.....	11
Out of Balance Load.....	12
Cycle Operation.....	13
Common Washer Sounds.....	15
Using Your Dispenser Drawer.....	15
Clothing Care.....	17
Maintenance.....	19
Lubrication.....	19
Cold Weather Care.....	19
Care of Your Washer.....	19
Cleaning Glass Sealing Area.....	19
Replacing Hoses.....	19
Filter Screens.....	19
Vacations and Extended Non-Use.....	19
Reinstallation of Shipping Materials.....	19
Cleaning Foreign Object Trap.....	20
Preventative Maintenance.....	20
Troubleshooting.....	21
Contact Information.....	24

Safety Information

Explanation of Safety Messages

Precautionary statements (“DANGER,” “WARNING,” and “CAUTION”), followed by specific instructions, are found in this manual and on machine decals. These precautions are intended for the personal safety of the operator, user, servicer, and those maintaining the machine.

	DANGER
Indicates an imminently hazardous situation that, if not avoided, will cause severe personal injury or death.	

	WARNING
Indicates a hazardous situation that, if not avoided, could cause severe personal injury or death.	

	CAUTION
Indicates a hazardous situation that, if not avoided, may cause minor or moderate personal injury or property damage.	

Additional precautionary statements (“IMPORTANT” and “NOTE”) are followed by specific instructions.

IMPORTANT: The word “IMPORTANT” is used to inform the reader of specific procedures where minor machine damage will occur if the procedure is not followed.

NOTE: The word “NOTE” is used to communicate installation, operation, maintenance or servicing information that is important but not hazard related.

Important Safety Instructions

Save These Instructions

	WARNING
To reduce the risk of fire, electric shock, serious injury or death to persons when using your washer, follow these basic precautions:	
W023	

- Read all instructions before using the washer.
- Install the washer according to the INSTALLATION INSTRUCTIONS. Refer to the EARTH/GROUND INSTRUCTIONS in the INSTALLATION manual for the proper earth/ground connection of the washer. All connections for water, drain, electrical power and earth/ground must comply with local codes and be made by licensed personnel when required. Do not do it yourself.
- Do not install or store the washer where it will be exposed to water and/or weather.
- Do not add the following substances or textiles containing traces of the following substances to the wash water: gasoline, kerosene, waxes, cooking oils, vegetable oils, machine oils, dry-cleaning solvents, flammable chemicals, thinners or other flammable or explosive substances. These substances give off vapors that could ignite, explode or cause the fabric to catch on fire by itself.
- Under certain conditions, hydrogen gas may be produced in a hot water system that has not been used for two weeks or more. HYDROGEN GAS IS EXPLOSIVE. If the hot water system has not been used for such a period, before using a washing machine or combination washer-dryer, turn on all hot water faucets and let the water flow from each for several minutes. This will release any accumulated hydrogen gas. THE GAS IS FLAMMABLE, DO NOT SMOKE OR USE AN OPEN FLAME DURING THIS TIME.
- To reduce the risk of an electric shock or fire, DO NOT use an extension cord or an adapter to connect the washer to the electrical power source.
- Do not allow children to play on or in the washer. Close supervision of children is necessary when the washer is used near children. This appliance is not intended for use by persons (including children) with reduced physical, sensory or mental capabilities, or lack of experience and knowledge, unless they have been given supervision or instruction concerning the use of the appliance by a person responsible for their safety. This is a safety rule for all appliances.
- Cleaning and user maintenance shall not be made by children without supervision.
- Children less than three years should be kept away unless continuously supervised.
- Do not reach into the washer if the washtub or agitator, if applicable, is moving.
- Never operate the washer with any guards, panels and/or parts removed or broken. DO NOT tamper with the controls or bypass any safety devices.
- DO NOT operate individual units if they have been separated from a stack unit.
- Use your washer only for its intended purpose, washing clothes. Always follow the fabric care instructions supplied by the garment manufacturer.

Safety Information

- Always read and follow manufacturer's instructions on packages of laundry and cleaning aids. To reduce the risk of poisoning or chemical burns, keep them out of the reach of children at all times (preferably in a locked cabinet). Heed all warnings or precautions.
- Do not use fabric softeners or products to eliminate static unless recommended by the manufacturer of the fabric softener or product.
- Loading door **MUST BE CLOSED** any time the washer is to fill, tumble or spin. **DO NOT** bypass the loading door switch by permitting the washer to operate with the loading door open.
- Be sure water connections have a shut-off valve and that fill hose connections are tight. **CLOSE** the shut-off valves at the end of each wash day.
- Keep your washer in good condition. Bumping or dropping the washer can damage safety features. If this occurs, have your washer checked by a qualified service person.
- Do not repair or replace any part of the washer, or attempt any servicing unless specifically recommended in the user-maintenance instructions or in published user-repair instructions that you understand and have the skills to carry out. **ALWAYS** disconnect the washer from electrical supply before attempting any service.
- Disconnect the power cord by grasping the plug, not the cord. If the supply cord is damaged, it must be replaced by the manufacturer, its service agent or similarly qualified persons in order to avoid a hazard.
- Before the washer is removed from service or discarded, remove the lid or door to the washing compartment.
- Failure to install, maintain, and/or operate this washer according to the manufacturer's instructions may result in conditions which can produce bodily injury and/or property damage.

NOTE: The WARNING and IMPORTANT SAFETY INSTRUCTIONS appearing in this manual are not meant to cover all possible conditions and situations that may occur. Common sense, caution and care must be exercised when installing, maintaining, or operating the washer.

Always contact your dealer, distributor, service agent or the manufacturer about any problems or conditions you do not understand.

Operation

Before Washing

Prepare Wash Load

Empty Pockets and Cuffs

Make sure all pockets are empty and turn them inside out. One bobby pin, metal or plastic toy, nail or sharp object in a load can catch laundry, cause tears and plug the pump. Facial tissue left in a pocket will produce extreme "lint". A crayon or lipstick in a wash load may cause stains that cannot be removed. Roll down cuffs and shake out grass, sand and gravel.



TLW1990N_SVG

Mend Rips and Tears

Little holes can become bigger in the washer. Mend holes and tears before placing garments in the washer.

Close Zipper and Fasten Hooks

These can catch on garments in a wash load and tear them. Tie belts and sashes so they won't wind around clothes.

Put Small Items in Bag

Small items such as baby socks may get stuck around the door. Put them inside a mesh garment bag.

Check For Colorfastness

Squeeze a portion of garment in warm or hot sudsy water. If the color bleeds or runs, wash the item separately in cold water.

Sort Items

Different items use different wash cycles and temperatures. Always follow the manufacturer's care label.



TLW1991N_SVG

Proper sorting is easy if you follow a few guidelines:

1. Sort by Color: Separate items into loads of whites, darks, lights and non-colorfast.
2. Sort by Fabric and Construction: Separate items into loads of cottons/linens, permanent press, synthetics/blends/poly knits, and delicates.
3. Sort by Temperature: Separate items into loads that can be washed in cold, warm or hot water.
4. Sort by Type and Amount of Soil: Heavily soiled clothes will need extra treatment. Lightly soiled clothes can become dingy if washed with heavily soiled items.
5. Sort Lint "Shedders" From Lint "Receivers": Some fabrics attract lint and should not be washed with lint-shedding loads. Lint shedders are cottons, terry towels, chenille bedspreads, rugs and clothes that have been heavily bleached. Lint receivers are synthetics, permanent or durable press, knits (including socks), corduroy, and other smooth fabrics.

Pretreat

Pretreat shirt collars and cuffs with a pretreat product or liquid detergent when placing them in the washer. Before washing, treat special stains individually.



WARNING

Do not wash or dry items soiled with vegetable or cooking oils. Some oils may remain after washing and may cause the fabric to catch on fire by itself.

W527

Loading the Washer

Load Articles

- Load items by the amount of space they take up, not by their weight. Mix large and small items in a load to get the best washing results.
- Load items loosely into the wash drum. The bulk of the clothes rather than the weight will determine load size.

Bulky Items

- Use the BULKY cycle for bulky items such as blankets and comforters. The cycle includes gentle agitation to clean items delicately and thoroughly. The Second Rinse Option may be selected to ensure complete removal of soap residue. A final spin extracts the moisture at a lower speed to maintain the load's balance and minimize wear to the articles.

Operation

Load Sizes

- Load sizes vary. Small and large items should be washed together to create a balanced load. If washing a large item, two bath towels should be added to even the load.
- Smaller loads can create an unbalanced condition and cause premature wear on the washer. Do not hesitate to fill the entire inner drum of the washer. The load will compress a great deal when wet. This allows room for proper tumbling.

Water Level

- The washer will automatically adjust the water level to the type and size of the load during any fill.

Wash Temperature

Hot

Hot water is the most effective for cleaning, but it is not recommended for all fabric types (read labels).

Warm

The Warm Wash is useful for providing a thorough cleaning on light and moderately soiled clothing without damaging fabric or adding to color fading. Warm water also reduces wrinkling. Use with non-colorfast or dark colors, permanent press, silks, woolens, nylon, and acrylic.

Cool

The Cool Wash temperature is useful for washing permanent press fabrics.

Cold

The Cold Wash is ideal for delicate items. Although its cleaning abilities are not as great as with hot or warm water, it is useful for colors that bleed easily and for sensitive fabrics.

All rinses use cold water. It is the most beneficial for fabrics. Cold rinses reduce wrinkling and color fading. In addition, cold rinses will save money and energy.

NOTE: In wash temperatures colder than 60°F (16°C), detergents do not dissolve well. This may cause ineffective cleaning, or lint and residue to form.

NOTE: Always follow manufacturer's care labels.

Wash Temperature Guide

Water Temperature	Use	Comments
HOT	<ul style="list-style-type: none"> • Sturdy whites and colorfast items • Work clothes 	<ul style="list-style-type: none"> • Best cleaning for soiled items • Good for sanitizing

Water Temperature	Use	Comments
	<ul style="list-style-type: none"> • Soiled items • Diapers 	
WARM	<ul style="list-style-type: none"> • Light and moderately soiled items • Non-colorfast or dark colors • Permanent press • Silks, woolens, nylon, acrylic 	<ul style="list-style-type: none"> • Reduces wrinkling in permanent press fabrics • Less fading • Reduces shrinking in knits
COOL	<ul style="list-style-type: none"> • Permanent press • Silks, woolens, nylon, acrylic 	<ul style="list-style-type: none"> • Less fading • Reduces shrinking in knits
COLD	<ul style="list-style-type: none"> • Non-colorfast fabrics • Extra delicate clothing 	<ul style="list-style-type: none"> • Saves energy • Reduces color fading • Reduces wrinkling • Reduces shrinking

Energy

You can save energy when washing by following a few guidelines:

1. Heating water accounts for the greatest energy expense when washing. Save on heating water by using warm or cold washes.
2. Wash full loads, but do not overload.
3. Use Soak option for heavily soiled items to reduce the need for higher soil level selections.

Control Panel

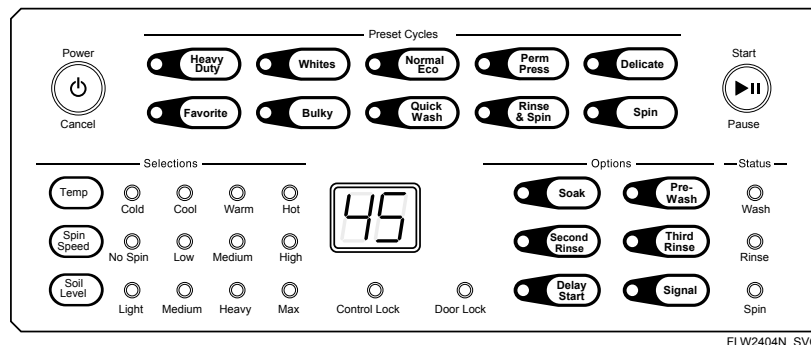

Digital Display

The two-digit display is used to show the time remaining in a cycle.

If the cycle time is over 99 minutes the control will display either 1H, 2H, etc., and then the additional minutes over one or two hours.

The display also shows diagnostic codes.

Idle Mode

If no keypads have been pressed for five minutes after a cycle is finished, the control will enter Idle Mode. A light in the lower right corner of the digital display will flash once each minute. Press the Power/Cancel keypad to exit this mode.

Cycles

The following cycle descriptions will help determine which cycle to choose depending on the type of laundry being washed. The descriptions are standard settings that may be modified using the Selections and Options.

Heavy Duty

Use for sturdy items, like play or work clothes, towels, T-shirts, etc. The cycle includes a longer wash tumble and two rinses. The final spin extracts moisture at a high spin speed.

Whites

This cycle is designed to keep white laundry white. It utilizes a longer, hot water wash tumble and two rinses. The final spin extracts moisture at a high spin speed.

Normal Eco

This cycle includes a wash tumble and two rinses, but uses less water than the other cycles. It also uses less hot water. Only the High Spin Speed is available in this cycle.

This cycle is recommended for washing everyday cottons and linens.

Perm Press

Use for permanent press items and synthetics. This cycle includes a wash tumble and two rinses. The final spin extracts moisture at a low spin speed.

Delicate

Wash delicate items usually washed by hand on this cycle. The cycle includes a wash tumble and two rinses. The final spin extracts moisture at a low spin.

Favorite

The Favorite cycle keypad allows the user to save different cycles, selections and options for later use. After pressing the Favorite keypad, the control will display the cycle and modifier settings for the first Favorite cycle. The 2-digit display will switch between F1 and the cycle time for the selected cycle. Pressing the Favorite keypad again will save the current settings and display the next Favorite cycle, F2. Pressing Start/Pause or Delay Start keypads will also save the current settings. Pressing Power/Cancel keypad will discard the currently selected Favorite cycle setting changes. Nine favorite cycles can be saved.

Bulky

Use this cycle when washing bulky items such as blankets and comforters. The cycle includes a wash tumble and two rinses. A final spin extracts the moisture at a medium speed to maintain the load's balance and minimize wear to the articles.

Quick Wash

Wash lightly soiled items on this cycle. The cycle includes a short wash tumble followed by one rinse. The final spin extracts moisture at a high speed spin.

Rinse & Spin

Use to quickly rinse items. The rinse is followed by a high spin.

Spin

Use this cycle to extract water from wet items. The cycle uses the high spin.

Selections

The following selections can be used to modify the currently chosen cycle. The default selections will be lit after choosing a cycle.

Temp

Press the Temp keypad to change the cycle's wash water temperature from the default selection to Cold, Cool, Warm, or Hot.

	WARNING
Window may be hot in the Hot Wash Cycle.	
W326	

Spin Speed

The Spin Speed selection will change the cycle's final spin from the default speed to No Spin, Low, Medium, or High spin.

Soil Level

Changing the Soil Level keypad will add more wash time to the cycle.

Choose Light, Medium, Heavy or Max according to the amount of soil in the laundry load.

Options

The following options can be used to modify the currently chosen cycle, signal volume and control lock.

Soak

The Soak option adds a 30 minute soak to the beginning of the cycle. During the soak period, the wash basket will rotate every few minutes to tumble the laundry.

Pre-Wash

The Pre-Wash option adds a second wash to the selected cycle.

Second Rinse

This Option will provide an additional rinse to the selected cycle. The water temperature will be cold.

Third Rinse

The Third Rinse Option provides two additional rinses. It is useful for detergent sensitive skin. The water temperature will be cold.

Delay Start

Pressing the Delay Start Option will allow the cycle to begin up to 24 hours after pressing the keypad. Pressing it once will delay the cycle by one hour and 1h will show on the control's display. Press the Delay Start keypad again to increase the time by one hour each press. Press the Start/Pause keypad to begin the countdown.

While setting the Delay Start Option, the cycle time and the Delay Start keypad light will flash (1 second on/off).

After the Delay Start Option is started, the Delay Start keypad light will flash (1 second on/off).

Signal

Pressing the Signal keypad will change the end of cycle signal volume. There are four settings: Off, Low, Medium, High.

Control Lock (Secure keypad)

Pressing and holding the Signal keypad for three seconds will turn on the Control Lock. The Control Lock status light will be lit. While Control Lock is on, no other keypad presses are allowed. Press and hold the Signal keypad again to turn the option off.

Status

The Status lights are lit during the cycle to show what part of the cycle is running.

Wash	The Wash status light is lit during the wash portion of the cycle including Pre-Wash and Soak, if selected.
Rinse	The Rinse status light is lit during the rinse portions of the cycle including Second Rinse and Third Rinse, if selected.
Spin	The Spin status light is lit during the final spin portion of the cycle.
Door Lock	The Door Lock status light is lit whenever the door is locked. The door cannot be opened while it is lit.

While the door is locking, the door lock status light flashes (1 second on/1 second off). While unlocking, the door lock status light stays lit and the cycle time flashes (1 second on/1 second off).

To Wash Clothes

IMPORTANT: Before using your new washer, make sure the washer cord is connected to an appropriate electrical outlet that is properly installed and connected to a protective earth/ground. Make sure the washer hoses are connected to the hot and cold water faucets, and that the faucets are turned on. Be sure the drain hose is not kinked and is inserted into a drain. Refer to the **INSTALLATION INSTRUCTIONS** for details of proper washer installation.

IMPORTANT: Prior to first wash, use an all purpose cleaner, or a detergent and water solution, and a damp cloth to remove shipping dust from inside of wash drum.

1. Get the clothes ready for washing. Empty pockets and cuffs. Sort items into separate loads. Pretreat stains and heavily soiled areas.



TLW1991N_SVG

IMPORTANT: Remove all sharp objects from laundry to avoid tears and rips to items during normal machine operation.

2. Measure and add low sudsing, high efficiency (HE) detergent, fabric softener and bleach to the dispenser drawer. Refer to section on Using Your Dispenser Drawer. Follow instructions on detergent package for amount to use.

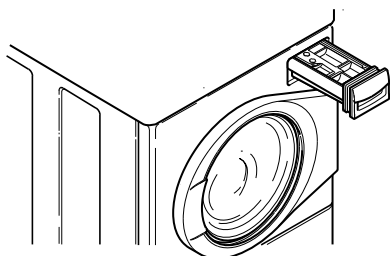

FLW2308N_svg

NOTE: High efficiency (HE) detergents are designed especially for frontload washers to reduce oversudsing and maximize cleaning results. Look for the HE logo or “high efficiency” on the detergent’s label.



IMPORTANT: If using non-HE detergent, avoid oversudsing by using only 1/2 of the detergent manufacturer's recommended amount.

3. Load clothes into wash drum (21 pounds [9.5 kg] maximum dry clothes load). Refer to section on Load Sizes.

NOTE: Small items such as baby socks may get caught around the door. Place these articles inside a mesh garment bag.

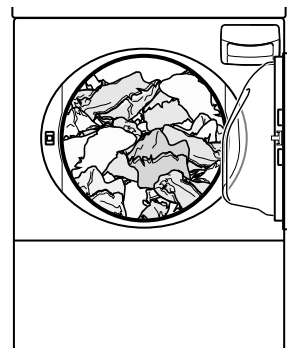

FLW2309N_SVG

4. Close the loading door tightly. The washer will not operate with the loading door open.

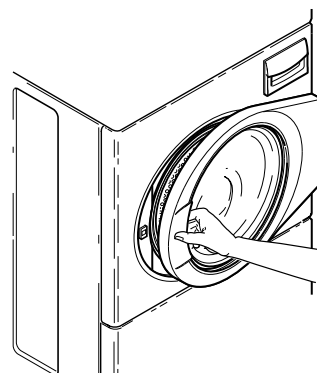

FLW2310N_SVG

	WARNING
<p>To reduce the risk of serious injury, do not bypass the loading door switch by permitting the washer to tumble or spin with the loading door open.</p> <p style="text-align: right;">W095</p>	

5. If not already on (control lights will be lit), turn on the washer. Press the Power button to turn on the washer.

NOTE: You will not be able to press the Start/Pause button to start a cycle until five seconds after turning on the washer. The display will show "--" if Start/Pause button is pressed during this warm-up period.

6. Select the cycle according to the type of fabric being washed. If the selected cycle is not the correct cycle for the fabric being washed, you may change the cycle selection at any time until the first wash fill is complete.

NOTE: The Normal Eco cycle is recommended for everyday cottons and linens.

7. If desired change the Selections and Options settings.
8. Press the Start/Pause button to begin the cycle. The Door Lock light will come on after a short delay and the cycle will begin.

NOTE: If the door is open when trying to start a cycle, the display will show "do" and cycle time (1 second on/1 second off).

If items need to be added or removed after a cycle has started, press the Start/Pause button. The door will unlock allowing the addition or removal of laundry. While a cycle is paused, the display will show the cycle time remaining and "St" to restart the cycle. Close the door and press the Start/Pause button to resume the cycle.

The door lock light will flash while the door re-locks.

Out of Balance Load

If at the end of the cycle the load is dripping wet, the washer has limited the spin speed. This is to prevent damage to the unit if there is a severely unbalanced load.

If this condition occurs, redistribute the load manually and run a SPIN cycle.

If the condition persists, consider steps discussed in the Before Washing section.

Cycle Operation

The cycles of your washer include several different stages. Refer to the table below for what can be expected during the cycles that you select.

The washer operates by gently tumbling the clothing through the water. The wash action consists of a period of tumbling in one direction, a brief pause, and then a reverse tumble in the opposite direction. The pauses are part of the tumble action and add to the unique cleaning capabilities of the washer. They are part of the cycle.

The wash and rinse spins utilize a "ramp spin" action. The wash drum starts rotating clockwise at a low speed and then gradually spins up to higher speeds to efficiently extract water.

The cycle stages are dependent on the cycle, selections and options chosen.

The times listed are approximate and will vary depending on the selections and options chosen.

NOTE: The rinse water temperature will be cold, including when optional rinses are selected.

NOTE: If No Spin is selected, all spin stages are one minute of drain and tumble.

Heavy Duty, Whites, Normal Eco, Perm Press, Bulky and Quick Wash Cycles			
Cycle Stage	Activity	Time (minutes)	Comments
Initial Drain	Drain	0:10	Removes water that might be left over from previous cycle
Wetting	Fill/Tumble	2:30	
Soak	Fill/Tumble/Soak	34:00	Option
Pre-Wash	Fill/Tumble	7:00	Option
Wash	Fill/Tumble	Heavy Duty = 15:00 Whites = 20:00 Perm Press = 12:00 Normal Eco = 14:00 Bulky = 11:00 Quick Wash = 4:00	
Spin	Ramp Spin	4:35	
Rinse	Fill/Tumble	3:25	Not active in Quick Wash Cycle
Spin	Ramp Spin	4:35	Not active in Quick Wash Cycle
Second Rinse	Fill/Tumble	3:25	Option
	Ramp Spin	4:35	Option
Third Rinse	Fill/Tumble	3:25	Option
	Ramp Spin	4:35	Option
	Fill/Tumble	3:25	Option
	Ramp Spin	4:35	Option

Heavy Duty, Whites, Normal Eco, Perm Press, Bulky and Quick Wash Cycles			
Cycle Stage	Activity	Time (minutes)	Comments
Final Rinse	Fill/Tumble	3:25	
Final Spin	Low, Medium or High Spin Speed depending on Selection	Bulky = 8:00 All Other Cycles = 9:00	
Fluff	Tumble	2:20	

Delicate Cycle			
Cycle Stage	Activity	Time (minutes)	Comments
Initial Drain	Drain	0:10	Removes water that might be left over from previous cycle
Wetting	Fill/Tumble	2:30	
Soak	Fill/Tumble/Soak	34:00	Option
Pre-Wash	Fill/Tumble	7:00	Option
Wash	Fill/Tumble/Distribute	8:00	
Rinse	Fill/Tumble/Distribute	4:25	
Second Rinse	Fill/Tumble/Distribute	4:25	Option
Third Rinse	Fill/Tumble/Distribute	4:25	Option
	Fill/Tumble/Distribute	4:25	Option
Final Rinse	Fill/Tumble	3:25	
Final Spin	Low, Medium or High Spin Speed depending on Selection	7:00	
Fluff	Tumble	1:30	

Rinse & Spin and Spin Cycles			
Cycle Stage	Activity	Time (minutes)	Comments
Initial Drain	Drain	0:10	Removes water that might be left over from previous cycle
Soak	Fill/Tumble/Soak	34:00	Option
Pre-Wash	Fill/Tumble	7:00	Option
Second Rinse	Fill/Tumble	3:25	Option

Rinse & Spin and Spin Cycles			
Cycle Stage	Activity	Time (minutes)	Comments
	Ramp Spin	4:35	Option
Third Rinse	Fill/Tumble	3:25	Option
	Ramp Spin	4:35	Option
	Fill/Tumble	3:25	Option
	Ramp Spin	4:35	Option
Final Rinse	Fill/Tumble	3:25	Not active in Spin Cycle
Final Spin	Low, Medium or High Spin Speed depending on Selection	9:00	
Fluff	Tumble	Rinse & Spin = 2:20 Spin = 1:50	

Common Washer Sounds

Sounds	Cause
Accelerating	This sound is heard during the spin portions of every cycle.
Tapping	These sharp sounds may come from metal fasteners, zippers, belt buckles or coins hitting the wash drum or door glass.
Thumping	Washer may be out of balance. Washer is designed to balance the load. If the washer is severely unbalanced, press the Start/Pause button and redistribute the load.
Rumbling	Washer may not be level. Stop washer and adjust leveling legs. Refer to INSTALLATION INSTRUCTIONS for details.

Using Your Dispenser Drawer

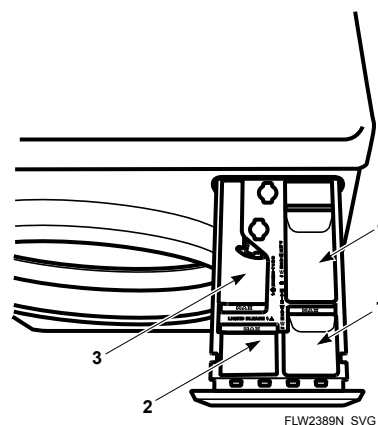

1. Main Wash Detergent
2. Liquid Bleach
3. Fabric Softener
4. Pre-Wash Detergent

Figure 1

Detergent Compartments

The detergent compartments are located on the right side of the dispenser drawer. The front compartment is for detergent used in the main wash. Refer to compartment 1 of illustration. If a pre-wash is selected, liquid wash detergent added to the main wash compartment may run into the load during the prewash. To avoid this, use powdered detergent in the main wash compartment when selecting a prewash. The rear compartment can be filled with deter-

Cycle Operation

gent for the pre-wash if one is selected on the control panel. Refer to compartment 4 of the illustration.

Use low sudsing, high efficiency (HE) powdered or liquid detergents that are recommended for use with frontload washers. Powdered bleach can also be used in the dispenser along with the detergent.

NOTE: High efficiency (HE) detergents are designed especially for frontload washers to reduce oversudsing and maximize cleaning results. Look for the HE logo or “high efficiency” on the detergent’s label.



NOTE: If using non-HE detergent, avoid oversudsing by using only 1/2 of the detergent manufacturer's recommended amount.

When adding detergent, use only the recommended amount. Do not fill the compartment over the maximum level indicated on the drawer. Adding too much detergent or using regular sudsing detergent could result in an oversudsing condition, which would require additional rinsing with cold water. Use care when adding detergent so as not to spill into the other compartments. Detergent mixed with fabric softener can make the softener gummy.

NOTE: The normal level of suds should be below center of the door.

Liquid Bleach Compartment

The bleach compartment is located in the left front corner of the dispenser drawer. Refer to compartment 2 of illustration. It has been designed to prevent the dispensing of undiluted bleach onto the clothes load.

Use liquid bleach in the dispenser. Powdered bleach must not be used in this compartment. Powdered bleach can be used in the detergent compartment only and can be added along with the detergent.

DO NOT use more than the maximum level indicated for the bleach compartment. Adding more than the maximum amount could result in early dispensing of the product and possible damage to fabrics.

Carefully pour recommended amount of bleach into the compartment before starting wash load.

Be careful not to spill undiluted bleach. It is a strong chemical and can damage some fabrics if it is not properly diluted. Follow bleach manufacturer's label for proper use.

Carefully close dispenser drawer. Do not allow bleach to spill into other compartments.

Fabric Softener Compartment

The fabric softener compartment is located in the left rear corner of the dispenser drawer. Refer to compartment 3 of illustration.

Use no more than the maximum level indicated for the fabric softener compartment. Adding more than the maximum amount could result in early dispensing of the product and possible staining of fabrics.

Add fabric softener to compartment before beginning wash load. The fabric softener will be dispensed during the last rinse stage of the cycle.

Carefully close dispenser drawer. Do not allow softener to spill into other compartments.

To Remove the Dispenser Drawer

Pull the drawer out until it stops. Then press the tab under the drawer to release and remove it.

To Clean the Dispenser

Pour hot water into the dispenser drawer, making sure it flushes through each compartment. Use a small brush to thoroughly clean out any residue.

Clothing Care

Clothing Concerns

To keep clothes looking white or bright, use good washing practices at all times to prevent a gradual build-up of soil or water hardness minerals on them. If you notice that your clothes are not as bright as they should be, take corrective measures immediately.

Problem	Cause	Solution
Gray or Dingy Clothes	Insufficient Detergent	Add recommended amount of low-sudsing detergent to dispenser drawer before loading clothes. Mild detergents are not suitable for average soil.
	Improper Sorting	Wash whites separately. Separate light from heavily soiled items. Clothes can pick up soil from dirty wash water.
	Nonphosphate Detergent and Hard Water	Follow package directions. Soften water if possible.
	Water Not Hot Enough	White clothes will stay whiter with hot wash water. Increase temperature.
Yellowed Clothes	Unremoved Soil	Skin soil is hard to remove. Check hem edge of sheets and pillowcases, bottom end of t-shirts, etc. If this portion is white and center is yellow, the fabric contains unremoved soil. Use sufficient detergent and a hot wash. Chlorine bleach may be needed.
	Clothes Stained from Iron in the Water	To test for an iron stain, use a rust remover that is recommended for use with washing machines on a portion of the garment. Follow bottle directions for larger items.
	Older Clothes	Some white fabrics turn yellow with age and cannot be whitened.
Clothes Tearing or Damaged	Improper Use of Chlorine Bleach	No correction for bleach damaged clothes. Always keep level at or below maximum in bleach dispenser compartment.
	Insufficient Pre-care	Fasten all hooks and zippers. Mend tears. Remove objects from pockets.

Problem	Cause	Solution
Excessive Lint	Improper Sorting	Fabrics that shed lint cannot be washed with fabrics that receive lint.
	Insufficient Detergent/Non-phosphate Detergent	Use enough detergent so lint remains suspended in water and flushed out. Do not oversuds the water.
	Mixing Fabric Types	Knits and permanent press attract lint. Wash these only with similar items. Use fabric softener in dispenser drawer.
Wrinkling	Improper Sorting	Heavy items like towels should not be washed with light items like nightgowns.
	Improper Cycle	Make sure cycle selected is appropriate for type of clothes.
	Improper Temperature	Using a warm or cold wash and a cold rinse reduces wrinkling.

Maintenance

Lubrication

All moving parts are sealed in a permanent supply of lubricant or are equipped with oilless bearings. Additional lubrication will not be necessary.

Do not lubricate the door hinge. If the hinge makes noise, replace the hinge.

Cold Weather Care

If the unit is delivered on a cold day (below freezing), or is stored in an unheated room or area during the cold months, do not attempt to operate the washer until it has had a chance to warm up. Water from the previous cycle may remain.

Care of Your Washer

Use only a damp or sudsy cloth for cleaning the control panel. Some cleaning products may harm the finish on the control panel or damage the interior. DO NOT use products that contain alcohol on the control panel. Wipe the panel dry after cleaning.

Wipe the washer cabinet as needed. If detergent, bleach or other washing products are spilled on the cabinet, wipe immediately. Some products will cause permanent damage if spilled on the cabinet.

Do not use scouring pads or abrasive cleansers.

The wash drum will need no particular care although it may need rinsing or wiping after an unusual load has been washed.

The outside of the door window can be cleaned with household window cleaner.

Leave the door and dispenser drawer open slightly when not in use. This will help keep them dry and prevent musty smells.

Running an occasional rinse cycle with bleach will help to avoid a musty smell in the wash drum.

Cleaning Glass Sealing Area

In order to assure that the door properly seals against water leaks, the following surfaces should be wiped off periodically:

- The outside perimeter of the door glass where the seal contacts the glass
- The front surface of the door seal lip

Usually a mild soap solution will work. If there is an extreme build-up of minerals from a hard water supply, the surfaces may need to be cleaned with a lime removal chemical.

Replacing Hoses

Hoses and other natural rubber parts deteriorate after extended use. Hoses may develop cracks, blisters or material wear from the temperature and constant high pressure they are subjected to.

All hoses should be checked on a monthly basis for any visible signs of deterioration. Any hose showing the signs of deterioration listed above should be replaced immediately. All hoses should be replaced every five years.

Filter Screens

Check the filter screens in the fill hoses for debris or damage every six months. Clean or replace them if necessary.

If the washer is filling with water slower than normal, check the filter screens. Clean or replace them if necessary.

Order filter screen Part No. 803615 from the nearest authorized parts distributor.

Vacations and Extended Non-Use

IMPORTANT: To avoid possible property damage due to flooding, turn off the water supply to the washer whenever there will be an extended period of non-use.

Leave the loading door and dispenser drawer open during extended periods of non-use to allow the wash drum and drawer to dry out and avoid a musty smell.

Reinstallation of Shipping Materials

To prevent damage while moving the unit, the shipping materials MUST be reinstalled.

1. Disconnect washer from electrical supply.
2. Remove two screws at bottom of front access panel.
3. Rotate bottom of panel out and remove panel.
4. Attach shipping brace to weight and base using four bolts and washers. Refer to Figure 2.
5. Reinstall front access panel.
6. Go to rear of washer to install rear shipping bolt, washer, spacer assemblies.
7. Insert shipping bolt assemblies into each shipping bolt hole. Refer to Figure 3.
8. Tighten bolt while pressing washer against rear panel to ensure spacer is fully inserted.

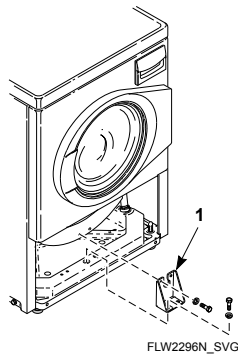

1. Shipping Brace

Figure 2

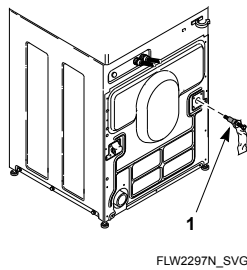

1. Shipping Bolt Assembly

Figure 3

Refer to the Installation instructions for proper procedures whenever the washer is moved.

Cleaning Foreign Object Trap

The washer's pump has a trap that may collect foreign objects. The trap may need to be cleaned if water is draining slower than usual. To clean:

1. Disconnect washer from electrical supply.
2. Remove two screws at bottom of the front access panel.
3. Rotate bottom of panel out and remove panel.

NOTE: The pump may have some water in it. Use a rag or a container to catch water. If the wash drum is full of water, use a wet/dry shop vacuum to catch the water.

4. With rag or vacuum ready, unscrew the cap on the left side of the pump and remove trap.
5. Clean the debris from the trap.
6. Reinstall the trap and access panel.
7. Reconnect washer to electrical supply.

Preventative Maintenance

Follow these guidelines to ensure the washer operates properly. Call for service if you observe any of the following: water of any amount on the floor, an increase in operating noise or water remaining in the wash basket after a cycle.

Frequency	Maintenance Procedure
Monthly	<ol style="list-style-type: none"> 1. Check all hoses and the drain for leaks. 2. Check the door lock for proper operation. 3. Clean the dispenser drawer. Refer to Using Your Dispenser Drawer. 4. Check to make sure the washer is level.
Every six months	<ol style="list-style-type: none"> 1. Clean the filter screens in the fill hoses. 2. Clean the door gasket with a bleach and water solution.
Every five years	<ol style="list-style-type: none"> 1. Have a qualified service technician conduct general preventative maintenance on the washer to ensure it operates properly. 2. Replace the fill hoses.

Troubleshooting

Try these troubleshooting tips before making a service call. They may save you time and money.

Washer Symptom	Possible/Cause Solution
Won't Fill	<ul style="list-style-type: none"> • Make sure power cord is plugged all the way into the electrical outlet. • Make sure hot and cold water faucets are turned on. • Make sure that the fill hoses are not kinked or twisted. • Press Start/Pause button to start washer. • Make sure that the controls are properly set. • Make sure that the loading door is closed tightly. • Check the laundry room fuse or circuit breaker. • Clean the screens in the water mixing valve and the filter screens located at the faucet end of the fill hoses. (Owner is responsible for service calls regarding cleaning of the screens.)
Won't Start	<ul style="list-style-type: none"> • Make sure that the loading door is closed tightly. • Press Start/Pause button to start washer. • Make sure power cord is plugged all the way into the electrical outlet. • Make sure that the controls are properly set. • Check the laundry room fuse or circuit breaker. • Make sure door latch is properly adjusted relative to door lock.
Won't Spin/Tumble	<ul style="list-style-type: none"> • Make sure that the loading door is closed tightly. • Press Start/Pause button to start washer. • Make sure power cord is plugged all the way into the electrical outlet. • Make sure that the controls are properly set. • Check the laundry room fuse or circuit breaker. • Broken drive belt. Call the service person. • Foreign object trap in pump may be clogged. Clean the trap. Refer to Maintenance section.
Stops/Pauses During Cycle	<ul style="list-style-type: none"> • Pauses are part of the washer's normal operation. • Check the laundry room fuse or circuit breaker. • Wash load may be unbalanced. Washer will stop and then re-start spin automatically. If the washer is severely unbalanced, press the Start/Pause button and redistribute the load.
Won't Drain	<ul style="list-style-type: none"> • Make sure drain hose is not kinked or twisted. • Make sure drain hose is not clogged. • Make sure drain receptacle is not clogged. • Refer to the Installation instructions to make sure that the drain hose has been properly installed. • Foreign object trap in pump may be clogged. Clean the trap. Refer to Maintenance section.

Washer Symptom	Possible/Cause Solution
Water Leaks	<ul style="list-style-type: none"> • Check that fill hoses are properly installed on the faucets and the washer's water mixing valve. • Check the condition of the fill hoses. Replace fill hoses every five years. • Check the condition of the rubber door gasket for tears or holes. • Make sure drain receptacle is not clogged. • Check laundry room plumbing. • Laundry load may be oversudsing. Make sure you are using low-sudsing, high efficiency (HE) detergent. • Laundry load may be overloaded. Make sure you are using proper load sizes. • Make sure outside perimeter of the door glass where seal contacts glass is clean.
Too Many Soap Suds	<ul style="list-style-type: none"> • Laundry load may be oversudsing. Make sure you are using low-sudsing, high efficiency (HE) detergent. • Make sure you are using the amount of detergent recommended on the detergent's label. If using non-HE detergent, use only 1/2 of the detergent manufacturer's recommended amount. • Laundry load may be overloaded. Make sure you are using proper load sizes.
Vibrates/Moves Slightly	<ul style="list-style-type: none"> • Make sure washer is level. Uneven leveling can cause vibration. • Make sure washer is installed on a solid, sturdy and level floor. The washer should not be installed on carpeting, soft tile or other weakly supported structures. • Make sure rubber feet are installed on all four leveling legs. Refer to Position and Level the washer. • Try placing the washer near a corner of the room or near an external structural support wall.
Is Noisy	<ul style="list-style-type: none"> • Make sure washer is level. Uneven leveling can cause vibration. • Some sounds may be a part of normal operation for a frontload washer, such as clicking noise when door locks and clicking noise from balance ring during agitate part of cycle.
Load is Too Wet	<ul style="list-style-type: none"> • Wash load may be unbalanced. The washer may have limited the spin speed to prevent damage to the machine. Redistribute the load and run a Spin cycle. • Load is too small. Add items to make full load.
Wrong Water Temperature	<ul style="list-style-type: none"> • Make sure that the controls are properly set. • Check fill hoses. Make sure hot faucet hose is connected to hot mixing valve (indicated with "H" on the valve bracket) and cold faucet is connected to cold mixing valve (indicated with "C" on the valve bracket). • Make sure laundry room water heater is adjusted properly.

Washer Symptom	Possible/Cause Solution
Control not responding to keypad selections	<ul style="list-style-type: none"> • Make sure Control Lock feature is off. If on, Control Lock light will be lit. • Press and hold Signal Keypad for three seconds to turn off.
Er, do on digital display	<ul style="list-style-type: none"> • The control senses that the door is open during a running cycle. • Unplug the machine to clear this code.
Er, dL on digital display	<ul style="list-style-type: none"> • The control senses that the door has unlocked during a running cycle. • Unplug the machine to clear this code.
Er, dr on digital display	<ul style="list-style-type: none"> • This code indicates that water is still in the washer at the end of the cycle. • Check the drain hose and drain receptacle to make sure they are installed properly and not blocked. • Foreign object trap in pump may be clogged. Clean the trap. Refer to Maintenance section. • Unplug the machine for 15 seconds to clear this code.
Er, FL on digital display	<ul style="list-style-type: none"> • This code will appear if the washer has not reached the fill level after 30 minutes during a wash or rinse fill. • Make sure hot and cold water faucets are turned on. • Make sure that the fill hoses are not kinked or twisted. • Clean the screens in the water mixing valve and the filter screens located at the faucet end of the fill hoses. • Unplug the machine for 15 seconds to clear this code.
Er, nF on digital display	<ul style="list-style-type: none"> • The washer has not filled to the proper water level. • No or very little change in water level has been sensed within 5 minutes of the current fill. • Make sure hot and cold water faucets are turned on. • Make sure that the fill hoses are not kinked or twisted. • Clean the screens in the water mixing valve and the filter screens located at the faucet end of the fill hoses. • Unplug the machine for 15 seconds to clear this code.
Er, OF on digital display	<ul style="list-style-type: none"> • This code indicates the washer has filled to the overflow level. • The machine will begin to attempt to pump water out if the door is closed and locked. • Foreign object trap in pump may be clogged. Clean the trap. Refer to Maintenance section. • If the code does not clear, unplug the machine and call for service.
Er, PS on digital display	<ul style="list-style-type: none"> • The control has detected trouble sensing the water fill level. • Unplug the machine and call for service.
Er, dU on digital display	<ul style="list-style-type: none"> • The control senses that the door will not unlock. • Unplug the machine for three minutes to unlock the door. • If the code appears again, call for service.

Washer Symptom	Possible/Cause Solution
Er, dl on digital display	<ul style="list-style-type: none"> • This code indicates that the door has not locked. • Make sure the door is closed all the way and try to start the cycle. • Open the door or unplug the machine to clear the code. • If this code continues, call for service.
Er, ub on digital display	<ul style="list-style-type: none"> • This code indicates that the wash load was unbalanced. • The unbalanced load may have limited the spin speed. • Be sure to use proper load sizes. • Open the door or press the Power/Cancel keypad to clear this code.
PF on digital display	<ul style="list-style-type: none"> • This code will be displayed if the control was in Delay Start Mode when a power failure occurred. • The delayed start will be canceled. • Press the Power/Cancel Pad to clear the code.
Er, SL on digital display	<ul style="list-style-type: none"> • This code will be displayed after a cycle for one minute, or until the Power/Cancel keypad is pressed, and indicates an oversudsing condition. • Laundry load may be oversudsing. Make sure you are using low sudsing, high efficiency (HE) detergent. If using non-HE detergent, use only 1/2 of the detergent manufacturer's recommended amount. • Laundry load may be overloaded. Make sure you are using proper load sizes.
Sr, cycle time remaining on digital display	<ul style="list-style-type: none"> • The control has detected an oversudsing condition and is running a special routine to remove the excess suds.

Contact Information

If service is required, contact the nearest Factory Authorized Service Center. To find the nearest service center, visit us online at www.speedqueen.com.

If you are unable to locate an authorized service center or are unsatisfied with the service performed on your unit, contact:

Speed Queen
Shepard Street
P.O. Box 990
Ripon, Wisconsin 54971-0990
www.speedqueen.com
Phone: (920)748-3121

Date Purchased _____

Model Number _____

Serial Number _____

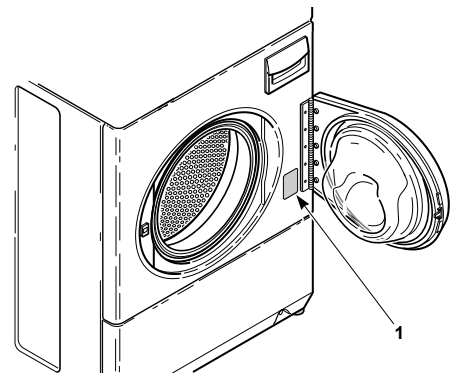

1. Serial Plate

When contacting us about your washer, PLEASE GIVE THE MODEL AND SERIAL NUMBERS. The model and serial numbers are located on the serial plate. The serial plate will be in the location shown. Please include a copy of your bill of sale and any service receipts you have.

If replacement parts are required, contact the source from where you purchased your washer or visit us online at www.speed-queen.com.



WARNING

To reduce the risk of serious injury or death, DO NOT repair or replace any part of the unit or attempt any servicing unless specifically recommended in the user-maintenance instructions or in published user-repair instructions that you understand and have the skills to carry out.

W329

