

Operating Instructions

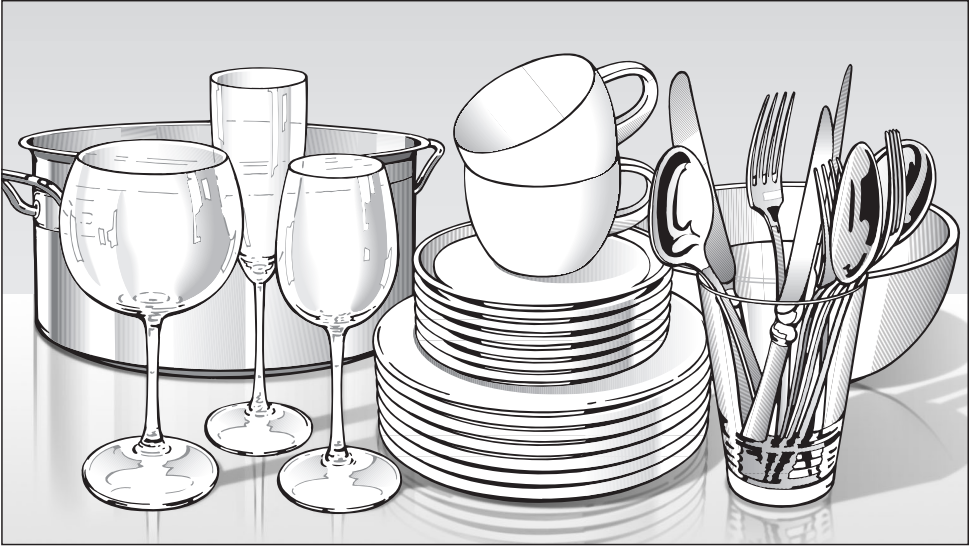

Commercial Dishwasher PG 8083 SCVi

To prevent accidents
and machine damage
read these instructions

before
installation or use.

en - US

M.-Nr. 09 501 400

Contents

Guide to the manual	5
IMPORTANT SAFETY INSTRUCTIONS	6
Guide to the commercial dishwasher	11
Overview	11
Control panel	12
Help to protect the environment	13
Before using for the first time	15
Opening the door	15
Closing the door	15
Display	16
Basic settings	17
Language	17
Water hardness	17
Filling the salt container	18
Refill salt indicator	20
Rinse aid	21
Adding rinse aid	21
Rinse aid indicator	21
Loading the dishwasher	22
Items not recommended for dishwashing:	23
Typical load for 10 place settings with cutlery tray	24
Typical load for 16 place settings with cutlery tray	25
Upper basket	26
Foldable spikes	26
Jumbo cup rack	27
Universal support bar	27
Adjusting the upper basket	28
Lower basket	29
Removable MultiComfort insert	30
Glass rack	30
Glass rack	31
Foldable spikes	31
Bottle holder	31
Cutlery	32
Split cutlery tray	32
Optional accessories	33



Use	34
Detergent	34
Adding detergent	35
Turning the dishwasher on	36
Selecting a program	36
Starting a program	36
Time display	37
Standby	37
End of program	38
Turning the dishwasher off	38
Unloading the dishwasher	38
Preparing your appliance for an extended vacation	38
Interrupting a program	39
Changing a program	39
Program guide	40
Additional options	45
Extra drying	45
Delay start	46
BrilliantLight	47
Settings	48
Opening the Settings menu	48
Language ^h	48
Water hardness	49
Rinse aid	50
Buzzer	50
AutoOpen	51
Optimize Standby	51
Refill messages	52
Brightness	52
Contrast	52
Filter check	52
External DOS	52
Detergent dosage	53
Venting the DOS system	53
High temp rinse	54
Water plus	54

Contents

Factory default	55
Select last program	55
Temp. display	55
To close the Settings menu	55
Cleaning and care	56
Cleaning the wash cabinet	56
Cleaning the door and the door seal	56
Cleaning the light guide.	56
Cleaning the control panel and exterior	57
Triple filter system	58
Cleaning the filters	58
Cleaning the spray arms	60
Frequently asked questions	61
Technical faults	61
Faults in the water intake or water drain	63
General problems with the dishwasher	65
Noises	67
Poor cleaning results	68
User maintenance instructions	71
Cleaning the water supply screen	71
Cleaning the drain pump and non-return valve	72
After sales service	73
Electrical connection	74
Plumbing	76
The Miele waterproof system	76
Connection to the water inlet	76
Water drainage	77
Technical data	78
Noise measurement	79
General requirements for measuring noise	79
Installation requirements for measuring noise	79

Warnings and notes

Warnings

-  Warnings marked like this contain safety information concerning potential injury and damage.
-  Read the warnings carefully and follow the instructions and directions.

Notes

Notes contain information that is particularly important to follow.

Additional information and comments

Additional information and comments are contained in a simple frame. They are not imperative.

Operating steps

Specially marked instructions indicate the steps for operating the dishwasher. They explain the procedure step by step. Operating steps are identified by a black square.

Example:

- Select the desired setting and press the centre button to confirm.

Display

The information is displayed in a special character font like that in the display.

Example:

When the display shows the message  End or **AutoOpen**
....

IMPORTANT SAFETY INSTRUCTIONS

WARNING -

When using your dishwasher follow basic precautions, including the following:

This dishwasher is intended for household and commercial applications.

Only use the machine for its intended purpose. Any other use, conversion or modification is dangerous.

This dishwasher complies with current safety requirements. Improper use of the machine can lead to personal injury and material damage.

Read all instructions before installing or using this machine.

Keep these operating instructions in a safe place and pass them on to any future user.

Intended use

▶ This dishwasher has short runtimes with heavy duty cleaning power and is intended for use in offices, lunch rooms, clubhouses, workshops, large kitchens and similar commercial environments.

This dishwasher can also be used in households and similar environments such as agricultural estates, hotels, motels, B&Bs and other typical domestic environments.

▶ This dishwasher is not intended for constant use.

▶ This dishwasher is not suitable for processing medical products.

▶ Use this commercial dishwasher only for dishwashing as defined in the Operating instructions, i.e. for cleaning dishes and cutlery. Any other use, conversion or modification is not permissible and possibly hazardous.

▶ This dishwasher is intended for stationary indoor use.

▶ The special inserts are to be used for their specific purpose only.

▶ Persons who lack physical, sensory or mental abilities, or experience with the machine should not use it without supervision or instruction by a responsible person.

IMPORTANT SAFETY INSTRUCTIONS

Proper installation

- ▶ Do not use the machine until properly installed.
- ▶ Do not install the machine in an area where a danger of explosion or of freezing temperatures may be present.
- ▶ To ensure the stability of undercounter dishwashers, they must only be installed beneath a continuous countertop that is bolted to the adjacent cabinetry.
- ▶ In order to reduce the risk of damage from condensation, the furniture in the area around the appliance should be designed for commercial use.

Technical safety

- ▶ Installation and repair work should be performed by a qualified and trained service technician in accordance with local and national safety regulations. Work by unqualified persons could be dangerous and may void the warranty.
- ▶ Before installation or service, disconnect the power supply to the work area by unplugging the unit, "tripping" the circuit breaker or removing the fuse.
- ▶ When work has been performed on the supply plumbing, the supply line to the commercial dishwasher must be bled. Otherwise, the water softening system may be damaged.

- ▶ Untrained personnel must not be permitted to operate the commercial dishwasher. Operating personnel must receive regular training.
- ▶ Before using the appliance, check for visible external damage. Never operate a damaged dishwasher. A damaged dishwasher can jeopardize your safety!
- ▶ Do not install or use a damaged dishwasher. A damaged machine is dangerous. Unplug the machine and call your Miele dealer or the Miele Technical Service Department.
- ▶ The appliance should only be repaired by Miele Customer Service, an authorized Miele dealer or an appropriately qualified technician. Otherwise the warranty becomes null and void.
- ▶ Defective components must be replaced with genuine Miele spare parts only. Only these parts are guaranteed by Miele to comply with safety requirements.
- ▶ Do not connect the appliance to the electrical power supply until all the installation work has been completed, including adjustment of the door spring.
- ▶ Be certain this machine is properly installed and grounded by an authorized technician. To guarantee the electrical safety of this machine, continuity must exist between the machine and an effective grounding system. It is imperative that this basic safety requirement be met. If there is any doubt, have the electrical system checked by a qualified technician.

IMPORTANT SAFETY INSTRUCTIONS

▶ Be sure to follow the installation instructions in this manual and in the installation diagram.

▶ Before connecting the appliance, ensure that the connection data on the data plate (voltage, frequency and fuse rating) match the building's electrical supply.

▶ **WARNING - Fire hazard!** Do not cover or crush the plug of the appliance. Ensure that the cabinet opening for the dishwasher provides ample space for the plug and cord. Installing the dishwasher in a tight space may crimp the power cord or put pressure on the plug which could cause overheating.

▶ Do not use an extension cord to connect this machine to electricity. Extension cords do not guarantee the required safety of the machine (e.g. danger of overheating).

▶ If the power cord is damaged it must only be replaced by a qualified Service technician with a genuine Miele power cord.

▶ Do not install this dishwasher beneath a cooking surface, oven or any appliance that radiates heat. High temperatures from these units may damage the dishwasher

▶ Do not open the appliance housing. Any interference with connections carrying voltage or changes in the electrical or mechanical set up, will endanger you and may impair the functioning of the appliance.

▶ Before servicing the appliance, disconnect it from the power supply.

▶ The plastic housing of the water connection contains an electric valve. The housing must not be immersed in water.

▶ The intake hose contains electrical wires. Therefore, do not shorten the hose.

▶ The built-in waterproof system offers reliable protection against water damage if the following conditions are met:

- proper installation,
- repair the appliance or replace parts when damaged,
- close the water supply during longer absences (e.g. vacation).

▶ The waterproof system also works when the commercial dishwasher is turned off. But it must not be disconnected from the power supply.

IMPORTANT SAFETY INSTRUCTIONS

Proper use

▶ The dishwasher is designed only for operation with water and the appropriate cleaning agents. **Organic solvents must not be used in the machine.** An explosion or machine corrosion could occur with the use of organic solvents.

Follow the instructions and relevant safety procedures carefully.

▶ Only use standard household mechanical dishwasher detergents in this unit. Keep all cleaning agents out of the reach of children. Use of unsuitable cleaning agents could adversely affect the components of the machine.

▶ To avoid corrosion damage ensure that solutions or steam containing hydrochloric acid do not come into contact with the steel outer casing of the machine.

▶ **BURN AND SCALD HAZARD**
This dishwasher reaches very high temperatures. Take care when unloading the unit. Let baskets and inserts cool before touching them. Any water which may remain in containers will be very hot and should be emptied into the wash cabinet.

▶ Under certain conditions, hydrogen gas may be produced in a hot water system that has not been used for two weeks or more. **HYDROGEN GAS IS EXPLOSIVE.** If the hot water system has not been used for such a period, turn on all hot water faucets and let water flow from each for several minutes before using the dishwasher. This will release any accumulated hydrogen gas. Do not smoke or use an open flame during this time.

▶ The water in the machine must not be used as drinking water.

▶ Pre-treatments with detergents can create suds, as can certain rinsing agents. For pre-treatment and / or cleaning only, use low-sudsing detergents. Suds can have an adverse effect on the cleaning process.

▶ Suds escaping from the wash cabinet can damage the appliance. If any suds are escaping, cancel the program immediately!

▶ Always follow the instructions of the chemical manufacturer when using detergents and special application chemicals. Only use such chemicals for the purpose and in the situation specified to avoid such dangers as chemical reactions and material damage.

▶ Do not sit or lean on the open door. This could cause the machine to be damaged.

▶ Do not leave the dishwasher door open when the machine is not in use. You could hurt yourself on the open door.

IMPORTANT SAFETY INSTRUCTIONS

- ▶ Avoid inhaling detergent. If swallowed, it can cause burning in the mouth and throat or inhibit breathing.
- ▶ Observe the detergent manufacturer's directions for storage, use and dosage of cleaning agents.
- ▶ Never clean the machine or near its vicinity with a water or high pressure hose.
- ▶ Be aware of the potential for injury when utensils with sharp, pointed ends are placed upright. Position them so they cannot cause injury.
- ▶ Remove all large food and liquid residues from the tableware before loading.

Children

- ▶ Always supervise any children in the vicinity of the appliance. Never allow children to play with the appliance. Among other hazards, children run the risk of locking themselves in the dishwasher!
- ▶ Do not allow children to play in or around the dishwasher, or to operate it.
- ▶ Keep detergents away from children! If detergents are ingested, they can cause chemical burns in the mouth and throat, or even suffocation. Therefore, keep children away from the dishwasher when open. There may still be detergent residues in the appliance. Seek medical help immediately if a child has ingested any detergent.

Accessories

- ▶ Only specific additional equipment, made by Miele or approved by Miele, should be used with this machine. Consult Miele on the type and application of such equipment.

Disposal of the old machine

- ▶ When disposing of your old dishwasher first make it unusable. Disconnect it from the mains power supply, cut off the cable and plug from the cable.
- ▶ For environmental and safety reasons ensure the machine is completely drained of any residual water and detergent. (Observe safety regulations and wear safety goggles and gloves).
- ▶ Remove the door to the washing compartment, so that children cannot accidentally shut themselves in. Make appropriate arrangements for the safe and environmentally responsible disposal of the machine.

For tank system machines ensure that all water is emptied out the tank.

SAVE THESE INSTRUCTIONS

Guide to the commercial dishwasher

Overview

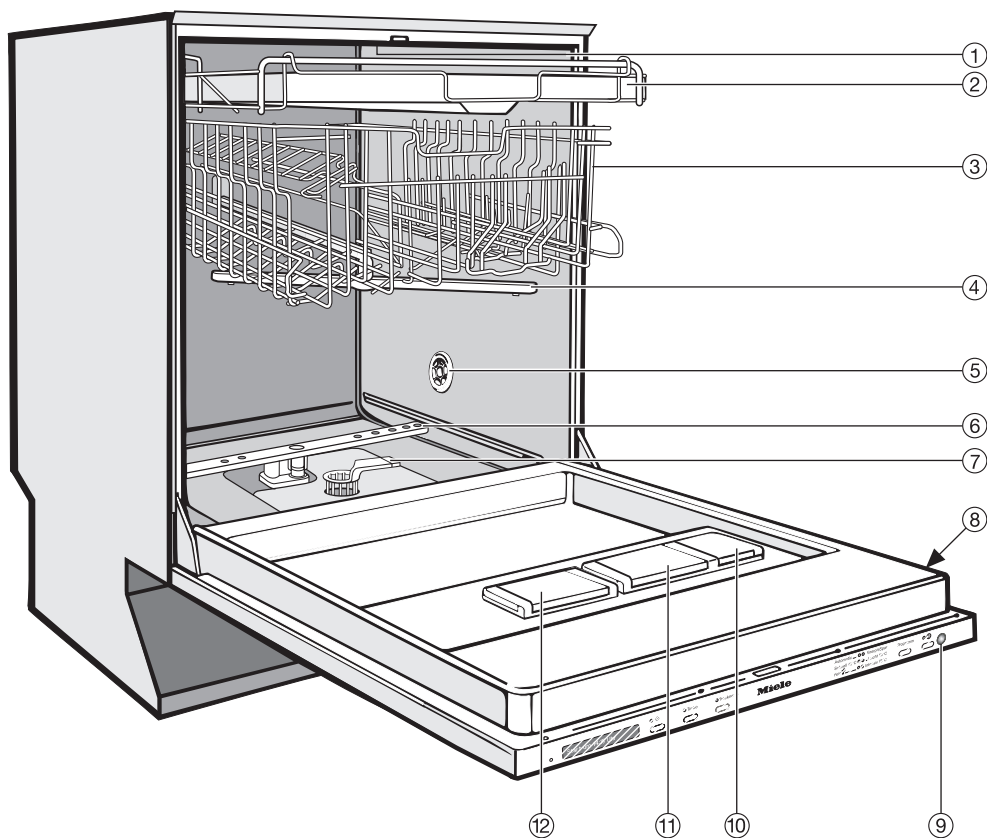

① Upper spray arm (not visible)

② Cutlery tray

③ Upper basket

④ Middle spray arm

⑤ Air inlet for drying

⑥ Lower spray arm

⑦ Filter combination

⑧ Data plate

⑨ Optical interface

⑩ Rinse aid reservoir



⑪ Dual-compartment detergent dispenser

⑫ Reservoir for regenerating salt

Guide to the commercial dishwasher

Control panel



- ① Display
- ②  > button, (other programs) with indicator light
- ③ Delay start button with indicator light
- ④ Extra drying button with indicator light
- ⑤ Program selection
- ⑥ Program button for program selection
- ⑦  button (On/Off) with indicator light
- ⑧ Optical interface

Disposal of the packing material

The cardboard box and packaging protect the appliance during shipping. These materials are biodegradable and recyclable. Please recycle.

Ensure that any plastic wrappings, bags etc. are disposed of safely and kept out of the reach of children.
Danger of suffocation!

Disposal of an old machine

Old appliances may contain materials that can be recycled. Please contact your local recycling authority about the possibility of recycling these materials.

Ensure that the appliance presents no danger to children while being stored for disposal. Before discarding an old appliance, unplug it from the outlet, cut off its power cord and remove any doors to prevent hazards. See "IMPORTANT SAFETY INSTRUCTIONS".

Help to protect the environment

Energy saving washing

This dishwasher is exceptionally economical in the use of water and electricity. For best results follow these tips:

- You may connect the commercial dishwasher to a hot water line. This is particularly suitable with energy-saving water heating sources such as solar energy systems. If the hot water system is electrically heated and if loads comprise primarily glassware we recommend connecting the appliance to the cold water line.
- For fastest possible wash times, with slightly higher energy consumption, connect the dishwasher to a hot water source.
- Make full use of the baskets without overloading for the most economical washing.
- Choose a program that best suits the degree of soiling and the type of dishes being washed.
- Use the Normal program for energy saving dishwashing. From the aspect of combined energy and water consumption, this program is the most efficient for washing normally soiled dishes.
- Observe the detergent manufacturer's recommendations for detergent dosage.
- When using powder or gel detergent, reduce the amount to $\frac{1}{3}$ of the normal amount when washing a small load.

Before using for the first time

Opening the door

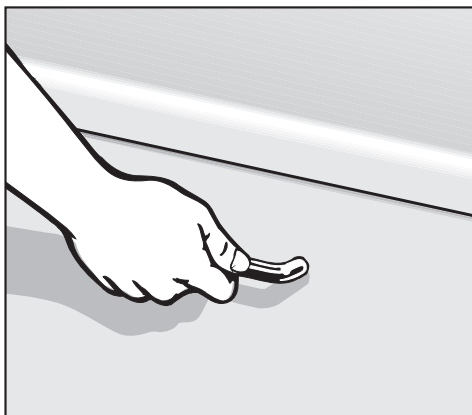

At the end of programs with a drying cycle (see Program guide) the door will automatically open a little in order to improve the drying.

You can cancel this function (see Settings menu - AutoOpen drying).

- Pull the handle to open the door.

If the door is opened during operation the dishwasher will automatically stop running.

 Do not block the area in which the door opens.

Closing the door

- Push the baskets in.
- Push the door until it clicks shut.

 Keep your fingers off the door frame. Risk of injury!

Before using for the first time

Display

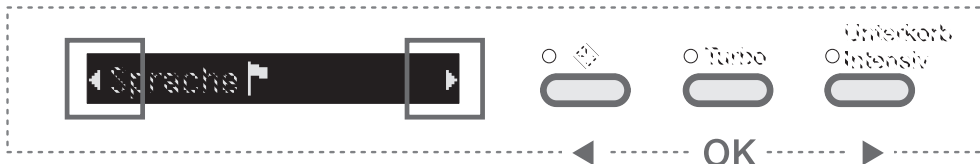

General

The following functions can be selected or set with the display:

- the wash program
- the Delay start time
- the settings

The following appears in the display while a program is running:

- the present program step
- the remaining runtime
- any faults or other messages

In order to save energy, the display will turn off within a few minutes if no program is running and no button is pressed. After several more minutes it switches off completely (see Use - Standby).

To turn the dishwasher back on, press the  button.

Settings menu

The Settings menu allows you to set the dishwasher to suit your requirements. See "Settings" for more information.

The normal functions of the buttons next to the display are not active with the Settings menu, allowing you to select and confirm menu items using these buttons.

The left and right arrows in the display indicate that additional selections are available. You can choose these selections with the left or right button below the display.

Use the center button below the display to confirm messages or settings and to switch to the next menu or submenu.

The currently selected setting is marked with a check .

Before using for the first time

Basic settings

- Press the  button to turn the dishwasher on.

If the dishwasher is being turned on for the first time, the welcome screen will appear.

Language

The display automatically switches to the language setting.

See "Display" for details.

- Select the desired language and press the center button to confirm.

The selected language is marked with a ✓.

Water hardness

The display changes to the water hardness setting.

- The dishwasher must be programmed to exactly match the hardness of your water.
- Your local water authority can tell you the water hardness level in your area.
- Where the water hardness fluctuates [e.g. 18 - 26 gr/gal (17 - 25 °d)], always program the dishwasher to the higher value [(in this example 26 gr/gal (25 °d)].

It is useful to know your water hardness so that you can provide the service technician with this information in the event of any service calls.



Please note your water hardness below:

_____ °d (gr/gal)

The water hardness factory setting is 15 °d (16 gr/gal).

- Select the hardness of your water supply and confirm with the center button.

See "Settings menu - Water hardness" for more information.

If the display now shows  **Add rinse aid** or  **Add salt**, press any button to confirm. The display changes to the main menu.

These basic settings are saved after the first full program cycle is completed.

The Welcome screen is no longer displayed after the first full program cycle is completed.

Before using for the first time

Every dishwasher is tested before leaving the factory. Any water remaining in the machine is from the final factory test and does not indicate that the machine has been used.

If the hardness of your water is always **below 4 °d (4 gr/gal)**, you do not need any salt.

However, you must still program your dishwasher for your water hardness.

Filling the salt container

To achieve good cleaning results, the dishwasher needs soft water (water that is low in minerals). Hard water results in calcium deposits on dishware and in the dishwasher.

Therefore, tap water with a hardness of 4 °d (4 gr/gal) or more must be softened. This takes place automatically in the integrated water softener. The water softener requires reactivation salt. The water softener is suitable for a water hardness of up to 36 °d (37 gr/gal).

See "Settings - Water hardness" for setting the water softener.

 Inadvertently filling the salt container with dishwashing detergent (including liquid detergent) will damage the water softener.

 Only use water softener salt specially formulated for dishwashers. Other salts may contain insoluble additives which can impair the water softener.

Before using for the first time

- Only open the door **half way** when adding salt to avoid spilling it.

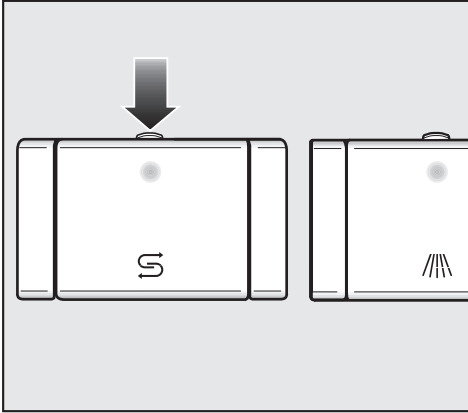

- Press the button on the top of the salt reservoir in the direction of the arrow. The cover will pop open.

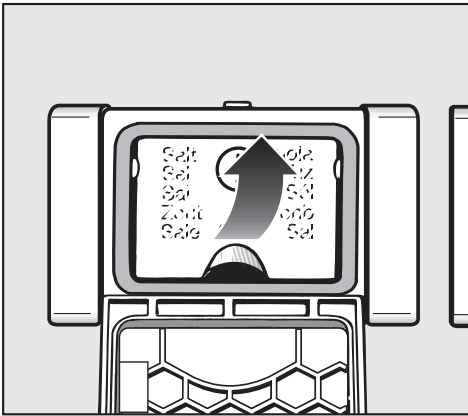

- Open the funnel.

Do **not** fill water into the salt reservoir!

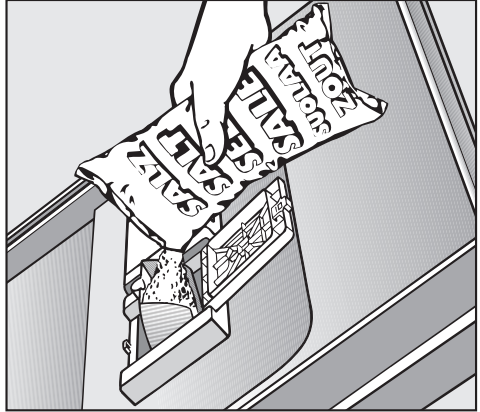

- Only add just enough salt to fill the reservoir. Depending on the type of salt, the reservoir will hold up to approx. 2.2 lbs (1 kg).

Never fill with more than 2.2 lbs (1 kg) of salt.

Displaced water may run out as the reservoir is being filled.

- Clean any excess salt from the filling area and close the cover of the reservoir.
- Immediately run the Pre-wash program without a load in order to remove any traces of salt from the chamber.

Before using for the first time

Refill salt indicator

- Refill the salt reservoir as soon as the  **Refill salt** message is displayed.
- Press the center button to confirm.

The Refill salt indicator goes out.

If a sufficiently high concentration of salt has not yet formed, Refill salt may continue to be displayed after adding the salt.

In this case, confirm again with the center button.

The Refill salt message is turned off if you have programmed the dishwasher to a water hardness below 4 °d (4 gr/gal).

 Immediately after each refill run the Pre-wash or Short program without a load in order to remove any traces of salt from the cabinet.

Before using for the first time

Rinse aid

Rinse aid helps to prevent spotting on dishes and glassware and speeds up the drying process.

The rinse aid is filled into the reservoir and the set amount will be automatically dispensed.

 Use rinse aid only. Never fill the rinse aid reservoir with regular dishwashing detergent or cleaning agent. This will damage the rinse aid reservoir.

Adding rinse aid

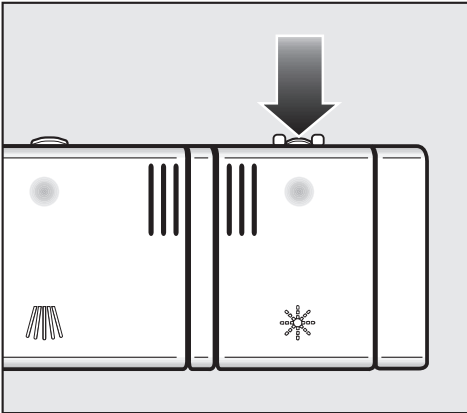

- Press the button on top of the rinse aid reservoir in the direction of the arrow. The cover will pop open.

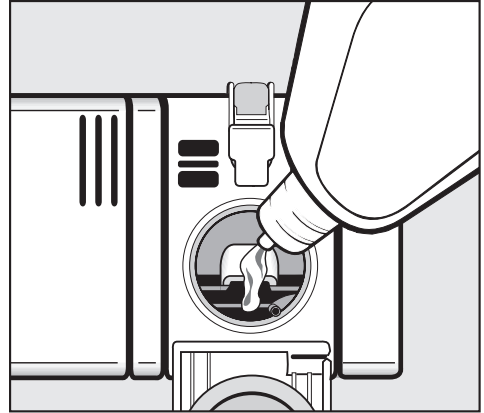

- Pour rinse aid into the reservoir until it is visible in the opening.

The rinse aid reservoir holds approximately 3.7 fl. oz. (110 ml).

- Close the cover until you hear it click shut, otherwise water might enter the reservoir during the wash program.
- Wipe up any spilled rinse aid to prevent over-foaming during the next wash program.

You can adjust the rinse aid dosage to optimize the results (see "Settings - Rinse aid").

Rinse aid indicator

When the  **Refill rinse aid** message appears, the reservoir only contains enough rinse aid for 2 - 3 wash programs.

- Add rinse aid soon.
 - Press the center button to confirm.
- The Refill rinse aid message goes out.

Loading the dishwasher

Tips:

Remove coarse food residues from the dishware.

There is no need to rinse items before loading into the dishwasher.

 Do not wash items soiled with ash, sand, wax, grease or paint in the dishwasher. These materials damage the dishwasher.

All items can be placed anywhere in the baskets. However, note the following:

- Do not place dishes or cutlery inside other pieces. They will cover each other.
- Load dishes so that water can reach all the surfaces. This ensures that the items will be properly cleaned!
- Make sure that all items are securely positioned.
- Hollow items such as cups, glasses and pots should be placed upside down in the baskets.
- Place tall, narrow, hollow items, e.g. champagne glasses, in the center of the basket rather than in the corners. This ensures good water coverage.

- Concave items such as mugs or bowls should be placed at an angle so that the water can run off.
- Ensure that the spray arms are not blocked by items that are too tall or that hang through the baskets. Check clearance by manually rotating the spray arms.
- Place very small items such as lids in the cutlery tray or basket (depending on the model) so they do not fall to the bottom of the wash cabinet.

Some foods, e.g. carrots, tomatoes and ketchup, may contain natural dyes. Plastic items may discolor permanently if they come in contact with food dyes. This discoloration does not affect the stability of the plastic items.

Items not recommended for dishwashing:

- Wooden cutlery and dishes or items with wooden parts: they discolor and fade. In addition, the glue used in these items is not dishwasher-proof. Result: wooden handles may come loose.
- Hand-crafted items, antiques, valuable vases and decorative glassware: these items are not dishwasher-proof.
- Plastic items which are not heat resistant: these items may become deformed.
- Copper, brass, tin and aluminium items: these may discolor or become dull.
- Colors painted over a glaze: these may fade after a number of washes.
- Fine glassware and crystal: they may become cloudy over time.

We recommend:

- When purchasing dishes and cutlery, make sure they are dishwasher-safe.
- Drinking glasses may become cloudy over time. Fine glassware should only be washed at low temperatures (see "Program guide") This reduces the risk of clouding.

Silver and aluminum:

- Silver or aluminum items may tarnish.
- Silverware previously cleaned with a silver polish may be damp or spotted at the end of a program where water has adhered to the polish. This can be rubbed off with a soft, dry cloth. Silver that has been cleaned in an immersion dip is usually dry at the end of a program, but may tarnish.
- If left to dry, foods containing sulfur can discolor silver. These include egg yolk, onions, mayonnaise, mustard, fish and marinades.
- Silverware may tarnish or pit if washed next to stainless steel. Leave space between these metals

 Aluminum components (e.g. grease filters) must not be washed with caustic alkaline commercial or industrial cleaning agents in the dishwasher. These may damage the material. In extreme cases they can cause a severe chemical reaction.

Loading the dishwasher

Typical load for 10 place settings with cutlery tray

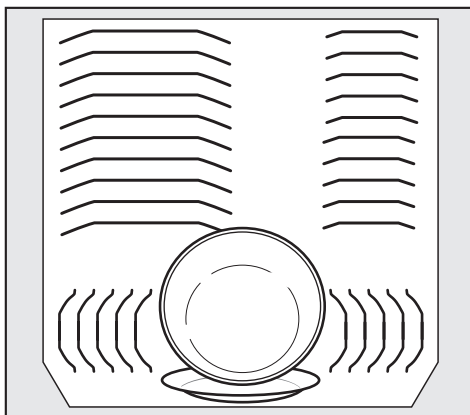
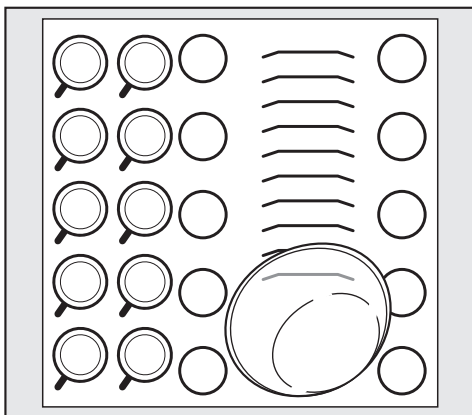

Upper basket

Lower basket

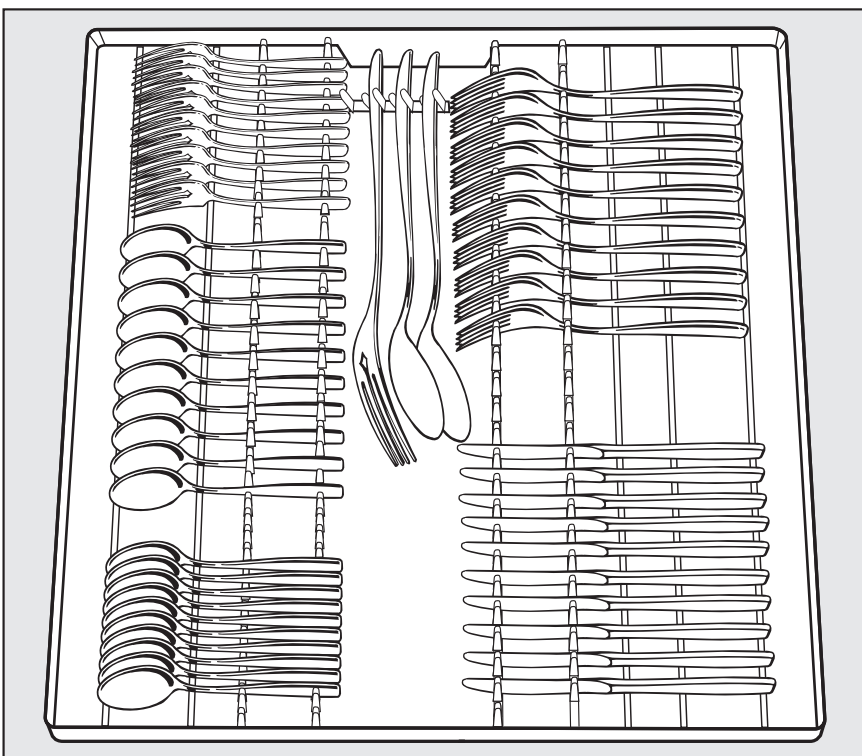

Cutlery tray

Loading the dishwasher

Typical load for 16 place settings with cutlery tray

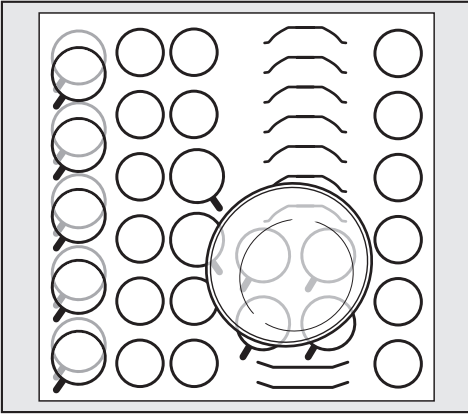

Upper basket

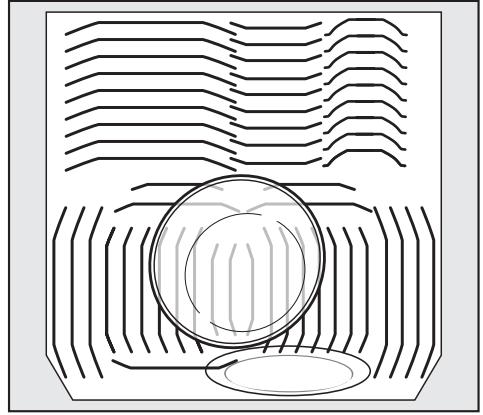

Lower basket

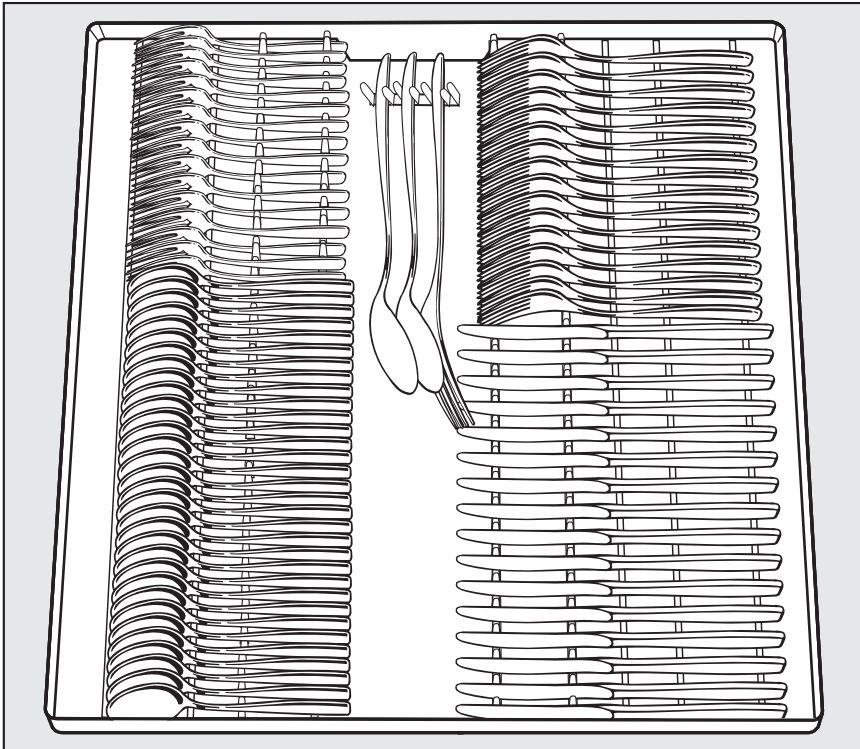

Cutlery tray

Loading the dishwasher

Upper basket

 Always use the dishwasher with the upper and lower basket inserted.

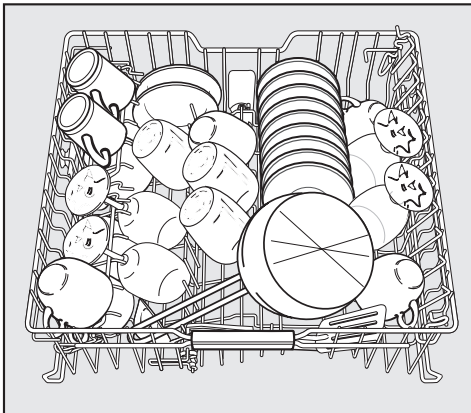

- Load the upper basket with small, lightweight, or delicate items such as cups, saucers, glasses, dessert bowls, etc.
Shallow pans can also be placed in the upper basket.
- Long items such as soup ladles, mixing spoons and long knives should be placed lying down across the front of the upper basket.

Foldable spikes

The rows of spikes can be lowered to make more room for larger items, such as casserole dishes.

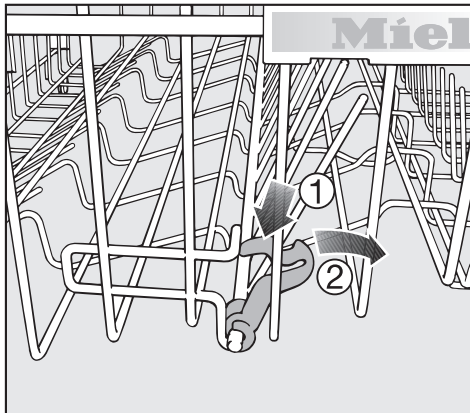

- Press the yellow lever down ① and fold the spikes down ②.

Hinged cup rack

- To make room for tall items, raise the rack upwards.

Glasses can be arranged along the cup rack to give them some support during the program.

- Lower the cup rack and lean the glasses against it.

Loading the dishwasher

Jumbo cup rack

The cup rack can be set to two different widths so that it can also accommodate large cups.

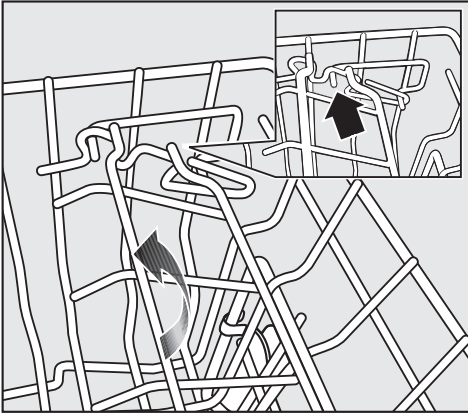

- Pull the cup rack upwards and click it back into position at the required width.

Universal support bar

The support bar will hold tall glasses and stemware securely.

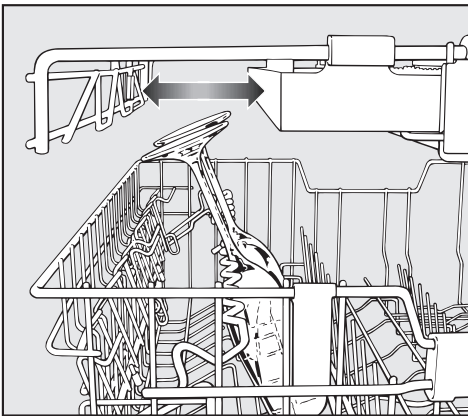

- Fold the support bar down and lean the glasses against it.

- If necessary, move one of the side inserts in the cutlery tray to make room for tall glasses.

Adjusting the height:

You can set the support bar to two different heights.

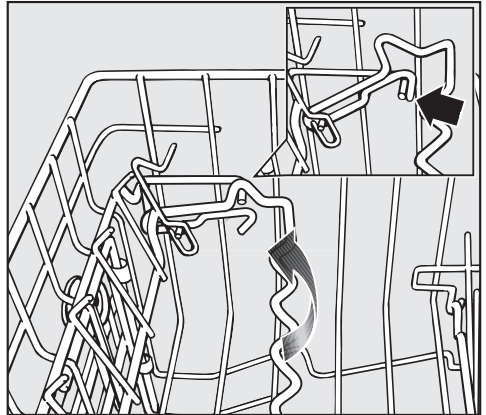

- Pull the support bar upwards and click it back into position at the required height.

Use the low setting for small glasses and tumblers.

Use the high setting for tall glasses and stemware.

Loading the dishwasher

Adjusting the upper basket

In order to gain more space for taller items in the lower or upper basket, the upper basket can be adjusted to three levels of about 2 cm height difference between each level.

The upper basket can also be set at an angle with one side high and the other side low to improve water drainage. However, make sure that the basket can slide smoothly in and out of the cabinet.

- Pull the upper basket out.

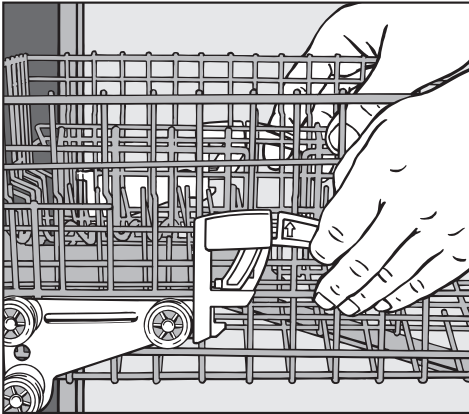

To adjust the upper basket upwards:

- Lift the basket up until it clicks into place.

To adjust the upper basket downwards:

- Pull upwards on the levers at the sides the basket.
- Adjust the basket to the desired height and then push the levers securely back down into position.

Depending on the setting of the upper basket, the following plate dimensions can be accommodated.

Dishwasher with a cutlery tray

Upper basket level	Plate dimension	
	Upper basket	Lower basket
Top	7 1/2" (19 cm)	12 1/4" (31 cm)
Middle	8 1/4" (21 cm)	11 7/16" (29 cm)
Bottom	9 1/16" (23 cm)	10 5/8" (27 cm)

Loading the dishwasher

Lower basket

- Place larger and heavier items such as plates, serving platters, saucepans, bowls, etc. in the lower basket. It can also be used for glasses, cups, small plates and saucers.

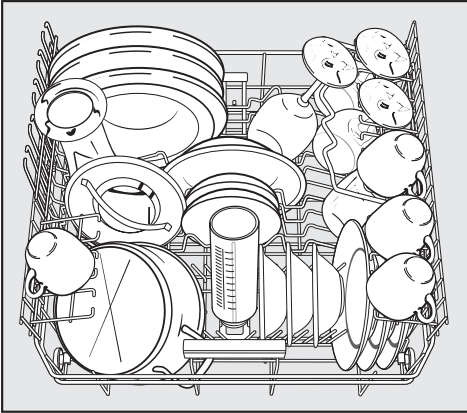

Commercial dishwasher with cutlery tray

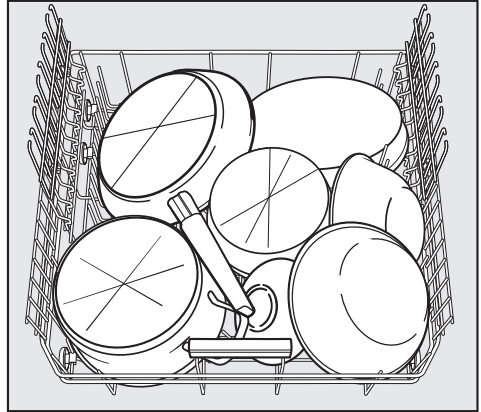

Heavily soiled items

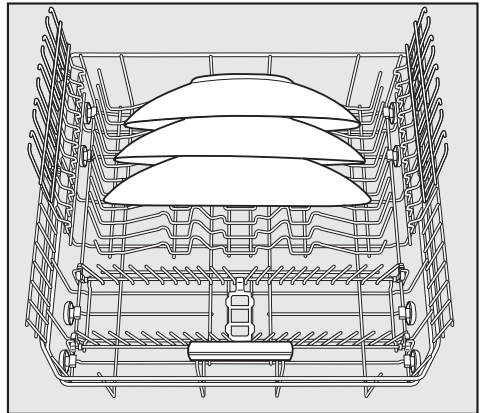

- Place very large plates in the center of the lower basket.

When tilted, plates up to 13 3/4" (35 cm) in diameter can be accommodated.

Loading the dishwasher

Removable MultiComfort insert

The rear section of the lower basket is used for cups, glasses, plates, pots and pans.

You can remove the MultiComfort insert to make more space for larger items such as pots and pans.

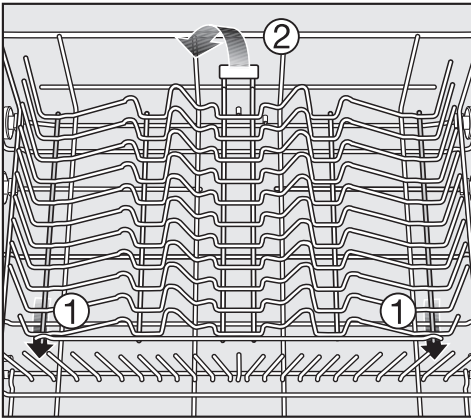

To remove the insert ①

- Press the yellow handle forwards and remove the insert.

To replace the insert ②

- Slide the hooks of the insert under the cross wire of the lower basket.
- Push down on the insert to snap it into position.

Glass rack

- The glass rack can be folded up to make more room for tall items.
- Stemware, e.g. wine, champagne and beer glasses, can be leaned against the glass rack or suspended from it.

The height of the glass rack is adjustable.

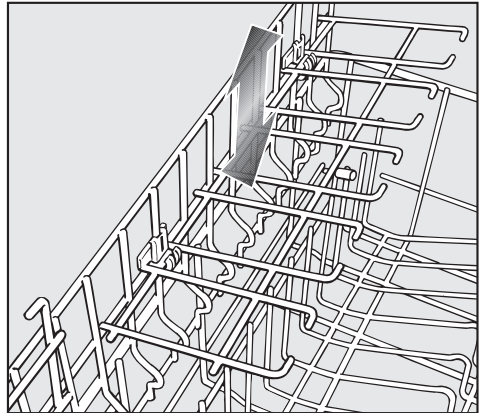

- Slide the glass rack to the desired height until the catches click into place at the top and rest on the bottom.

Loading the dishwasher

Glass rack

The glass rack can hold tall glasses and stemware securely.

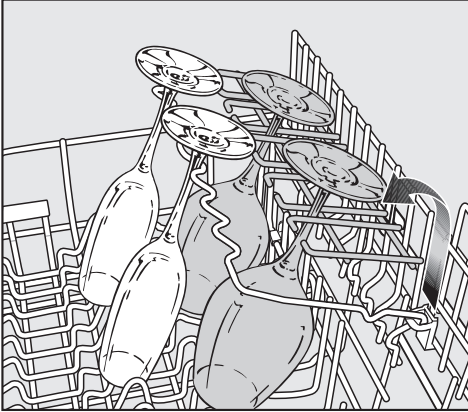

- Fold the support bar down and lean the glasses against it.

Foldable spikes

The spikes at the front are used for plates, soup bowls, platters, desert bowls, and saucers.

Both rows of spikes can be folded down to create more room for larger dishware, e.g. pots, pans and bowls.

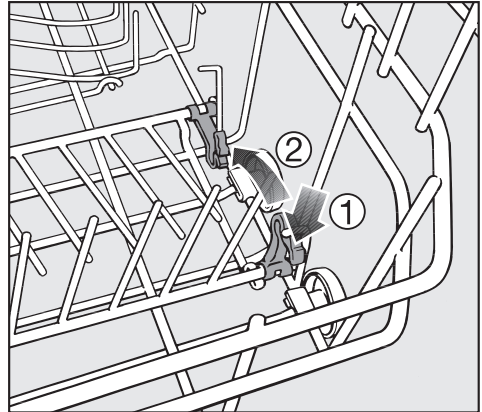

- Press the yellow lever down ① and fold the spikes down ②.

Bottle holder

The bottle holder is for washing narrow items e.g. for milk bottles or baby bottles.

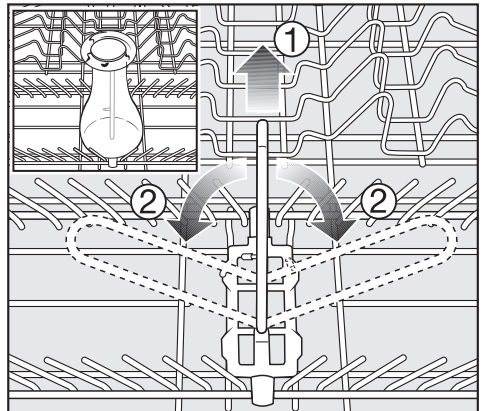

- Pull the bottle holder up ① and fold it sideways ② when it is not in use.

Loading the dishwasher

Cutlery

Split cutlery tray

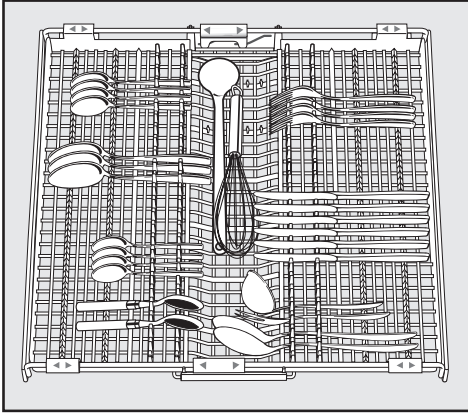

- Arrange the cutlery in the tray as shown.

To make unloading much easier, cutlery can be grouped in zones, one for knives, one for forks, one for spoons, etc.

Spoon heads should be placed in contact with at least one of the serrated retainers on the base of the cutlery tray to ensure that the water runs off them.

Make sure that large items (e.g. cake servers, etc.) do not block the upper spray arm!

The side inserts of the tray can be moved into the middle to accommodate tall items in the upper basket.

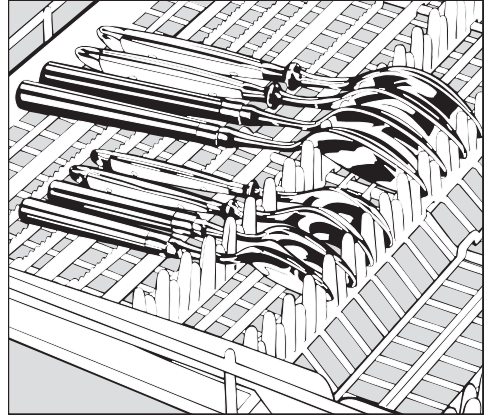

If spoon handles do not fit between the holders, put them the other way round.

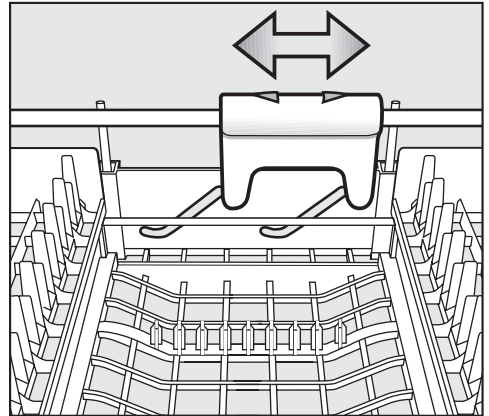

To make more room for larger items of cutlery, you can use the yellow slider to adjust the height of the middle section of the cutlery tray.

Optional accessories

Optional dishwasher accessories are available from your Miele dealer, Miele or Mieleusa.com (depending on your model some may already be supplied with your machine as standard).

If you would like to...

the following accessory will need to be ordered...

...wash a Miele Cappuccinatore

... a Cappuccinatore insert for the upper basket.

...wash additional items of cutlery

... a cutlery basket for the lower basket.

...wash long-stemmed glassware

... a glassware rack for the lower basket.

MieleCare Collection

Miele branded cleaning and care products, including dishwasher salt, detergent and rinse aid, are available to order from your Miele dealer, Miele or the on-line Miele store www.mieleusa.com

Use

Detergent

 Avoid inhaling powder detergents. Avoid swallowing dishwasher detergent! Detergents can cause chemical burns to nose, mouth and throat. Consult a doctor immediately if detergent has been swallowed or inhaled.

 Always keep detergent out of the reach of children. Keep children away from the dishwasher when the door is open. There could still be detergent residues in the cabinet. Fill the detergent dispenser just before starting the program and lock the door with the child safety lock.

Dishwasher detergents contain irritant and corrosive ingredients.

Use only the recommended amount of detergent. Continued use of too much detergent may cause machine damage.

Never use detergent tablets. The tabs do not dissolve completely during the short program runtimes.

Whether you use powder or liquid detergent, always observe the manufacturer's instructions.

Powder detergents

Use only powder detergent in the dispenser in the door.

- Pour powder detergent into the compartments of the detergent dispenser.

Detergent dosage

- Unless otherwise specified, depending on the degree of soiling, pour approximately 1 ¼ and 2 tablespoons (20 and 30 ml) of powder detergent into compartment II.
For heavily soiled dishware, pour a small amount of detergent into compartment I (see Program guide).

Adding detergent

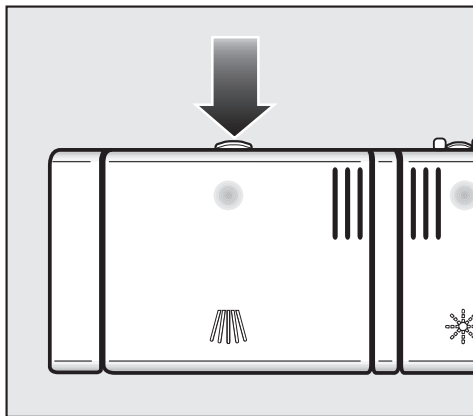

- Press the button on top of the detergent dispenser. The cover will pop open.

The cover is always open at the end of a program.

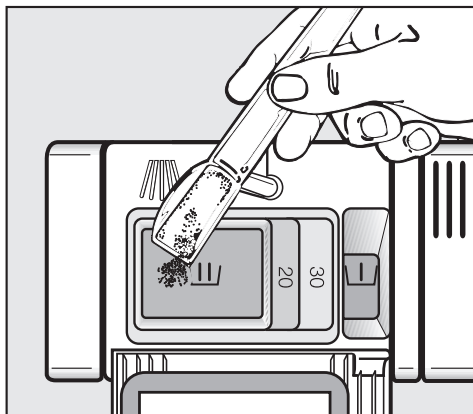

- Add detergent to the compartments and close the cover.
- Do not forget to close the detergent container. Otherwise, the detergent might clump.

Detergent dosing aid

Compartment I holds a maximum of 2 teaspoons (10 ml), compartment II holds a maximum of 3.5 tablespoons (50 ml) of detergent.

The horizontal marks in compartment II indicate the levels of approximately 1 ¼ and 2 tablespoons (20 and 30 ml) respectively. The marks indicate the approximate fill level in ml when the door is open in a horizontal position.

Use

Turning the dishwasher on

- Open the water supply if it is closed.
- Open the door.
- Make sure the spray arms can rotate freely.
- Press the  button to turn the dishwasher on.

The factory-set ECO program will appear in the display and the matching indicator light will come on.

After a short while, the estimated time for the selected program will appear in the display.

You can also change the setting to the program you last used (see "Settings - Program preselection").



Selecting a program

Choose the program according to the type of dishware and soiling.

See the **Program guide** for a description of the programs and their applications.

- Use the  button to select the desired program.

The indicator light for the selected program comes on.

When the indicator light next to  lights up, you can select additional programs using the  > button.

You can now select additional options (see Additional options).

Starting a program

- Close the door to start the program.

The optical interface lights up to confirm the start of a program sequence.

If additional functions are selected, the corresponding indicator lights will also come on.







Cancel a program only in the first few minutes.

Otherwise important program steps (e.g. water softening) may be canceled.

Time display

Before the program starts, the time display shows the runtime of the selected program in hours and minutes. The remaining time is displayed during the program.

Symbols will appear to indicate the stage of the program:

-  Pre-wash
-  Main wash
-  Interim rinse
-  Final rinse
-  Drying
-  End

The time that is displayed may vary for the same program. It depends on the temperature of the incoming water, the reactivation cycle and the quantity of dishes.

When a program is selected for the first time, the display shows an average program time for warm water.

Standby

A few minutes after the last button is pressed or a few minutes after the end of the program the dishwasher will switch to Standby mode to save energy. The display and the indicator lights are turned off and only the  indicator light flashes slowly.

- Press the  button to turn the indicator lights back on.

If you do not turn off the dishwasher after the program ends, it will automatically turn off completely after a few minutes in Standby mode (see "Settings - Optimize Standby").

If Refill salt, Refill rinse aid or a fault is displayed during a program, the dishwasher will not switch to Standby mode.

The refill messages can be turned off to let the dishwasher go into Standby mode without first refilling (see "Settings - Refill messages"). However, fault messages cannot be turned off.

Use

End of program

At the end of a program, the optical interface flashes with the door closed.

The program has finished when  **End** or **AutoOpen** is displayed and the door is slightly ajar.

If Extra drying was selected and AutoOpen is active, the drying fan will run for a few minutes after the program has ended.

- Open the door all the way to reset the door latch.
- Unload the dishwasher.

If the door is closed, the optical interface goes out 10 minutes after the program has ended.

 If if the AutoOpen function is deactivated (see Settings menu - AutoOpen) and you want to open the door after the program has ended, open the door all the way. Otherwise steam from the dishwasher could damage the edge of the countertop because the fan is no longer running.

Turning the dishwasher off

At the end of a program:

- Open the door.
- Press the  button to turn the dishwasher off.

The dishwasher will continue to use electricity until it is turned off with the  button.

Unloading the dishwasher

Dishes tend to break and chip more easily when they are hot.

Leave the dishes in the dishwasher until they are cool enough to handle before unloading them.

The dishes will cool much faster if you open the door when the program has ended.

Unload the lower basket first, then the upper basket and then the cutlery tray (depending on model).

This will prevent water from the upper basket and cutlery tray from dripping onto dishes in the lower basket.

Preparing your appliance for an extended vacation

If you elect to turn off the water to your home for an extended period of time, please note that this may not be enough to reduce the risk of a leak.

To be completely safe, you must turn off the water supply to each individual appliance. This means under the sink for a dishwasher, at the laundry bib for your washer, etc.

Interrupting a program



A program will be interrupted as soon as the door is opened. When the door is closed again, the program will continue from where it was interrupted.

 Water in the dishwasher is hot. Danger of scalding. Only open the door if absolutely necessary and exercise extreme caution when doing so. Before closing the door again, leave it ajar for approx. 20 seconds. This will enable the temperature in the wash cabinet to settle. Close the door firmly until it clicks into place.

Changing a program

If the detergent dispenser cover has already opened, powder detergent must be added for the new program unless liquid detergent is being dispensed.

If a program has already started and you wish to change it:

- Open the door.
- Press the  button to turn the dishwasher off.
- Press the  button to turn the dishwasher back on.
- Use the program button to select the desired program.
- Close the door to start the program.

The optical interface lights up to confirm the start of a program sequence.

Program guide

Program	Application	Detergent	
		Follow the detergent manufacturer's instructions	
		Compartment I ¹⁾	Compartment II ¹⁾
ProSpeed	For fresh, non-sticky food residues		1 oz
Universal	For normal, slightly dried food residues		1 oz
Pots & Pans	For burned-on, very adherent, very dry, starchy or albuminous ¹⁾ food residues.	1/3 oz	1 oz
China & Crystal	Special glassware program		1 oz
Sanitize	Special hygiene program for dishware requiring a high degree of hygiene.		1 oz
Plastics	Special plastics program		1 oz

¹⁾ see "Use - Detergent"

Program sequence								
Pre-rinse	Main wash	Interim rinse I	Interim rinse II ²⁾	Final rinse	Drying	Extra drying	Auto Open	Water plus
	X 149°F (65°C) 1 min	X 10 s	(X)	X 149°F (65°C) ³⁾ 30 s		(X)	⁴⁾	(X)
	X 149°F (65°C) 10 min	X 3 min	(X)	X 149°F (65°C) ³⁾ 1.5 min		(X)	(X)	(X)
X 8 min	X 167°F (75°C) 10 min	X 3 min	(X)	X 149°F (65°C) ³⁾ 1.5 min		(X)	(X)	(X)
	X 122°F (50°C) 1 min	X 3 min	(X)	X 122°F (50°C) 1 min		(X)	(X)	(X)
X 8 min	X 167°F (75°C) 10 min	X 3 min	(X)	X 158°F (70°C) ³⁾ 3 min	X 30 min		(X)	(X)
X 10 min	X 122°F (50°C) 1 min	X 5 min		X 140°F (60°C) 30 s	X 45 min		(X)	

X = part of the program

(X) = additional, optional program steps

²⁾ Interim rinse II, must be programmed by a Miele service technician.

³⁾ Optional temperature increase to 167°F (75°C).

⁴⁾ No AutoOpen at the program end because of the short program runtime.

⁵⁾ Without rinse aid and with cold water.

Program guide

Program	When to use	Detergent	
		Follow the detergent manufacturer's instructions	
		Compartment I ¹⁾	Compartment II ¹⁾
Glass no rinse aid (beer glasses)	Special program without rinse aid, recommended for beer glasses. (The glasses do not dry through their own heat after the program has ended and might have to be dried by hand).		1 oz
Normal *)	Program for completely washing a full load of normally soiled dishware. Standard program for washing normally soiled dishes.		1 oz
Pre-rinse	For rinsing off very soiled dishware, e.g. to remove soiling in advance or to prevent residues from drying on the dishware when it is not worth running an entire program.		

*) From the combined aspect of energy and water consumption, this program is the most efficient for this type of dishes. (this program sequence cannot be changed)

¹⁾ see "Use - Detergent"

Program sequence								
Pre-rinse	Main wash	Interim rinse I	Interim rinse II ²⁾	Final rinse	Drying	Extra drying	Auto Open	Water plus
	X 122°F (50°C) 1 min	X 3 min		X — ⁵⁾ 1 min				
	X 103°F (41.5°C) 47 min	X 3 min		X 106°F (49.5°C) 5 min	X 45 min		(X)	
	X Cold 8 min							

X = part of the program

(X) = additional, optional program steps

²⁾ Interim rinse II, must be programmed by a Miele service technician.

³⁾ Optional temperature increase to 167°F (75°C).

⁴⁾ No AutoOpen at the program end because of the short program runtime.

⁵⁾ Without rinse aid and with cold water.

Program guide

Program	Consumption ⁶⁾			Time ⁶⁾	
	Electrical energy		Water	Water cold 15°C	Water hot 55°C
	Water cold 15°C	Water hot 55°C			
ProSpeed	1.7 kWh	0.9 kWh	17 l	35 min ⁷⁾	25 min ⁷⁾
Universal	1.7 kWh	1.0 kWh	17 l	48 min ⁷⁾	38 min ⁷⁾
Pots & Pans	2.0 kWh	1.0 kWh	23 l	64 min ⁷⁾	52 min ⁷⁾
China & Crystal	1.1 kWh	0.4 kWh	17 l	29 min ⁷⁾	20 min ⁷⁾
Sanitize	2.3 kWh	1.3 kWh	23 l	101 min	89 min
Plastics	1.4 kWh	0.5 kWh	23 l	94 min	81 min
Glass no rinse aid	0.7 kWh	0.4 kWh	17 l	24 min	19 min
Normal *)	1.2 kWh	0.5 kWh	17 l	124 min	115 min
Rinse & Hold	0.03 kWh	0.03 kWh	5 l	11 min	11 min

*) From the combined aspect of energy and water consumption, this program is the most efficient for this type of dishes. (this program sequence cannot be changed)

⁶⁾ Values are calculated for a connected load of 4.2 kW. Significant differences may occur due to varying conditions. The displayed time reflects your household conditions.

⁷⁾ Wash time only (without drying time).

Extra drying

For better drying results and to reduce the amount of steam that escapes when the door is opened, the Extra drying function extends the fan runtime at the end of the program.

This function is not available for all programs.

When Extra drying is selected, the total program runtime will increase by approx. 20-30 minutes, depending on the program.

- Open the door.
- Press the  button to turn the dishwasher on.

The  indicator light comes on.

- Select the desired program.
- Press the Extra Drying button.

Extra Drying indicator lights up if this function is available for the selected program.

- Close the door to start the program.

Additional options

Delay start

The start time of a program can be delayed from 30 minutes to 24 hours. The delay is set in 30 minute increments.

When using the Delay start function, make sure that the detergent compartment is dry before adding detergent. Wipe dry if necessary. Otherwise the detergent could clump and not rinse out completely.

- Open the door.
- Press the  button to turn the dishwasher on.

The  indicator light comes on.

- Use the Program button to select the desired program.
- Press the Delay start button.

The last Delay start time will appear in the display. The Delay Start indicator light comes on.

- Set the desired Delay start time using the Delay Start button.

If you press and hold the Delay Start button, the time will increase automatically to **24:00 h**. Then press the Delay Start button twice to start at 30 minutes again.

- Close the door.



If you don't close the door within a few seconds after you have set the Delay start time, the program runtime will again appear in the display. You will have to set the Delay start time again.

The time starts counting down in minutes until the program start time.

When the set time is reached, the selected program will start automatically. The optical interface lights up.

Starting a program before Delay start has elapsed:

A program can be started before the Delay start time has elapsed. Just do the following:

- Open the door.
- Press the  button to turn the dishwasher off.
- Press the  button to turn the dishwasher back on.
- Use the Program button to select the desired program.
- Close the door to start the program.

The optical interface lights up to confirm the start of a program sequence.

BrilliantLight

The commercial dishwasher is equipped with interior lighting. The lighting switches off automatically when the door is open for longer than 15 minutes.

You can permanently switch off the interior lighting.

- Swing the door of the dishwasher halfway open and closed quickly three times. Move the door far enough that the interior lighting goes on and off.





This permanently switches off the interior lighting.

- Do the same again to reactivate the lighting.

Settings

Settings menu for changing standard settings

Opening the Settings menu

- If the dishwasher is on, press the  button to turn it off.
- Press and hold the  button.
- Press the  button to turn the dishwasher on, and hold the  button down for at least 4 more seconds.

The first option of the Settings menu appears in the display and all the indicator lights comes on.

See the "Display functions" section for details.

- Select the menu setting you wish to change.

The selected options in the submenu are marked with a check .

Language

The display can be set to different languages.

The displayed language can be changed in the **Language ** submenu.

- Select the desired language and press the center button to confirm.

The flag after the word **Language** serves as a guide if an unfamiliar language is set. In this case, select the menu option with a flag until the **Language ** submenu is displayed.

Water hardness

Your dishwasher comes with with a water softener.

You must set the system to the water hardness level of your water supply.

- The dishwasher must be programmed to exactly match the hardness of your water.
- Your local waterworks can tell you the water hardness level in your area.
- Where the water hardness fluctuates always program the dishwasher to the higher value.

The set water hardness is marked with a check ✓.

- Select the hardness of your water and press the center button to confirm.

°d	gr/gal	Setting in display
1	1	1
2	2	2
3	3	3
4	4	4
5	5	5
6	6	6
7	7	7
8	8	8
9	9	9
10	10	10
11	11	11
12	12	12
13	13	13
14	14	14
15	15	15
16	16	16
17	17	17
18	18	18
19	19	19
20	20	20
21	21	21
22	22	22
23	23	23
24	25	24
25	26	25
26	27	26
27	28	27
28	29	28
29	30	29
30	31	30
31	32	31
32	33	32
33	34	33
34	35	34
35	36	35
36	37	36

Settings

Rinse aid

For best results the rinse aid dosage can be adjusted. The dosage can be set between 0-6 ml. The factory setting is 3 ml of rinse aid.

- Use a higher setting if spots appear on dry glassware.
- Use a lower setting if streaking appears on dishes or glasses.
- Select the desired amount of rinse aid and press the center button to confirm.

Buzzer

If activated, the buzzer sounds at the end of a program and when a fault occurs.

Buzzer at the end of a program

The buzzer at the end of a program sounds at intervals of four times with a brief break in between. The buzzer sounds if you do not turn off the dishwasher beforehand.

Buzzer sounds for a fault

The fault buzzer sounds at intervals of four times without pausing.

The buzzer for a fault cannot be turned off.

Setting the buzzer volume

There are seven different volume settings for the buzzer. The buzzer is deactivated if no volume setting is selected.

- Select the desired volume and press the center button to confirm.

AutoOpen

To improve drying, the door automatically opens a little at the end of a program, except for Pre-rinse, Short and Beer glasses (see Program guide).

With the Universal, Intensive and Glassware programs, AutoOpen can only be activated by selecting Extra drying (see "Additional options - Extra drying").

You can also deactivate this function.

- Select the desired setting and press the center button to confirm.

 If you have deactivated the AutoOpen function but would still like to open the door at the end of a program, make sure that you open the door completely. Otherwise steam from the dishwasher could damage the edge of the countertop because the fan is no longer running.

Optimize Standby

A few minutes after the last button is pressed or a few minutes after the end of the program the dishwasher will switch to Standby mode to save energy. The display and the indicator lights are turned off and only  flashes slowly.

If you do not turn the dishwasher off when the program has ended, it will switch off automatically after several minutes in Standby.

You can also deactivate the Optimize Standby function. The display and the indicator lights do not go out, and the dishwasher turns off 6 hours after the end of the program.

This results in higher energy consumption.

- Select the desired setting and press the center button to confirm.

If Refill salt, Refill rinse aid or a fault is displayed during a program, the dishwasher will not switch to Standby mode.

Settings

The refill messages can be turned off without first refilling to let the dishwasher go into Standby mode. But the fault messages cannot be turned off.

Refill messages

If you want the dishwasher to switch to Standby mode in spite of a refill message, you can switch both indicator lights off together.

- Select the desired setting and press the center button to confirm.

Brightness

There are seven different brightness levels for the display.

- Select the desired brightness and press the center button to confirm.

Contrast

There are seven different contrast levels for the display.

- Select the desired contrast and press the center button to confirm.

Filter check

You can set the length of the interval between filter checks as a reminder. You can set an interval between 30 and 60 wash cycles.

The factory setting is an interval of 50 wash cycles.

You can also deactivate this function.

- Select the desired setting and press the center button to confirm.

External DOS

Activate automatic dispensing of liquid detergent if you have installed a optional external dosing module.

Please check with Miele Technical Service if a suitable external dosing module is available for your voltage configuration.

- Select the desired setting and press the center button to confirm.

The setting will remain active until you deactivate External DOS.

Detergent dosage

This function becomes visible when External DOS is activated.

You can set the detergent dosage in milliliters or percent according to the manufacturer's instructions for liquid detergent.

- **Unit of measurement in ml**
The factory setting is 30 ml.
The dosage can be set from 10 - 100 ml in 2 ml increments.
- **Unit of measurement in percent**
The factory setting is 0.50%.
The dosage can be set from 0.17 - 1.67% in increments of 0.03 - 0.04%.

Setting the dosage:

Set the dosage according to the detergent manufacturer's recommendations.

The dishwasher uses approx. 6.5 l of water for the main wash cycle.

Example:

The detergent manufacturer recommends 4 ml (or 0.07%) of detergent per litre of water.

$6.5 \text{ l} \times 4 \text{ ml/l} = 26 \text{ ml}$.

$(6.5 \text{ l} \times 0.07 \text{ %/l} = 0.455\%)$.

- Select the desired amount of detergent or the dosage concentration and press the center button to confirm.

Venting the DOS system

The DOS system will not dispense reliably if there is air in the system.

The DOS system must be vented

- if it is being used for the first time,
- if the liquid detergent reservoir was not refilled on time and the DOS system was sucked empty.

 To ensure that the DOS system functions properly, prior to venting make sure that the detergent container is full enough and that the dispensing lances are firmly attached to the containers.

- Select **Start venting** and press the center button to confirm.

The venting process begins. The remaining time appears in the display.

The Pre-rinse program is offered directly after the venting process is finished. Start the program in order to dilute and drain any detergent that escaped into the wash cabinet.

Settings

High temp rinse

For better drying, the rinse temperature can be increased. This function is not available for all programs (see "Program guide").

- Select the desired setting and press the center button to confirm.

Water plus

When selected, more water will be used for the wash cycle. This function is not available for all programs (see "Program guide").

- Select the desired setting and press the center button to confirm.

Factory default

You can reset all settings back to the factory default settings. An activated External Dos and its respective amount of detergent or dosage concentration will not be reset.

- Select **Reset** and press the center button to confirm.

Select last program

You can chose whether to preset the Normal program or the last selected program.

- Select the desired setting and press the center button to confirm.

Temp. display

During a program the current temperature is displayed as factory default setting.

If the temperature display is turned off the remaining run time is being displayed during a program.

- Select the desired setting and press the centre button to confirm.

To close the Settings menu

You can close the Settings menu with **Finish**.

- Select **Finish** and press the center button to confirm.

The last selected program is displayed briefly and the respective indicator light comes on.

After a short while, the estimated program runtime is displayed.

Cleaning and care

Check the overall condition of your dishwasher regularly (approx. every 4 - 6 months). This will help to prevent problems.

 The outer surfaces of the dishwasher are susceptible to scratching. Contact with unsuitable cleaning agents can alter or discolor the outer surfaces.

Cleaning the wash cabinet

The wash cabinet is largely self-cleaning, provided that the correct amount of detergent is used.

If, however, there are limescale or grease deposits in the cabinet, these can be removed with a special dishwasher cleaner (available from Miele).

Washing at low temperatures can allow germs and odors to build up inside the appliance. To prevent this, run an intensive program with detergent after approx. 20 program cycles with low temperatures.

Cleaning the door and the door seal

- Wipe the door seals regularly with a damp cloth to remove food deposits.
- Wipe food and drink residues off the dishwasher door. These surfaces are outside the wash cabinet and are not reached by water from the spray arms.

Cleaning the light guide

The light guide for the optical interface is located in the cover plate under the counter.

- If necessary, clean the light guide with a moist cloth or a household cleaner that is safe for plastics.

Cleaning the control panel and exterior

 Remove any soiling immediately. Otherwise it might become impossible to remove and could cause an alteration or discoloration of the surfaces.

- Clean the control panel with a moist cloth **only**.
- Clean the front of the appliance with a clean sponge, liquid dish soap and warm water. Then wipe dry with a soft cloth.
To clean, you can also use a clean, damp microfiber cloth without detergent.

Glass cleaners may be used to clean the exterior. However **do not** allow them to sit or "puddle", this can cause damage to the surface.

Remove the cleaner promptly.

To better maintain your appliance avoid the following:

- cleaners containing soda, ammonia, thinners, or chlorides
- cleaners containing descaling agents or lime removers,
- abrasive cleaners,
- stainless steel cleaners,
- dishwasher soap (powder),
- caustic (oven) cleaners,
- scouring pads, steel wool, hard brushes,
- metal scrapers,
- steam cleaning products.

Cleaning and care

Triple filter system

The triple filter system in the base of the wash cabinet retains coarse dirt from the suds solution, preventing it from reaching the circulation system and re-entering the cabinet through the spray arms.

 The dishwasher must not be used without all the filters in place.

Collection of coarse dirt may cause the filters to clog. The level of soiling and time it takes before the filters need cleaning will vary depending on your household use.

The message **Check filters** will appear in the display after every 50 program cycles (factory default setting).

The filter check frequency can be set from 30 and 60 program cycles (see "Settings, filter check").

- Check the triple filter system.
- Clean the triple filter, if necessary.
- Confirm the message with the center button.

The last selected program is displayed briefly and the respective indicator light comes on.

After a short while, the estimated program time is displayed.

Cleaning the filters

- Turn the dishwasher off.

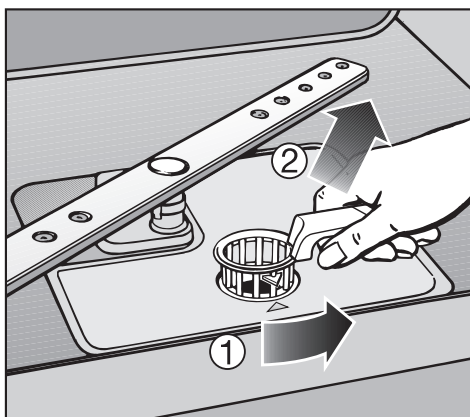

- Turn the handle counter-clockwise to release the triple filter system ①.
- Take the filter combination out ②, remove any coarse particles and rinse the filter well under running water. Use a brush if necessary.

 Make sure that when cleaning the filters, no coarse dirt falls into the circulation system, causing a blockage.

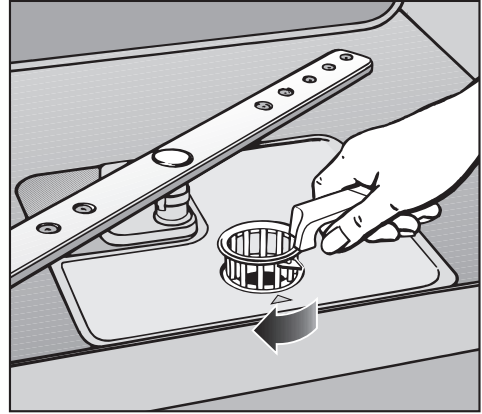
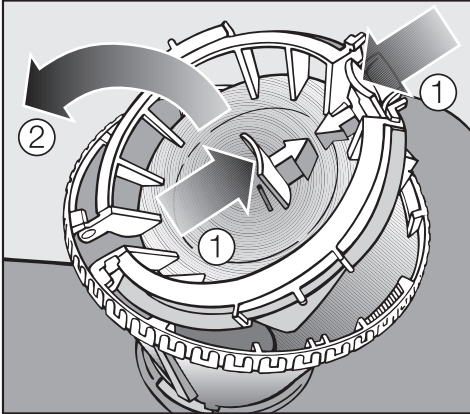

The cover must be opened to clean the inside of the filter:

- Push the clips together in the direction of the arrows as shown ①, and open the cover ②.
- Clean all parts under running water.
- Close the cover so that the lock engages.

- Replace the triple filter so it lies flat in the base of the wash cabinet.
- Lock the filter by turning the handle clockwise, until the arrows point to each other.

 The triple filter system must be inserted correctly and locked. Otherwise large particles could get into the circulation system and cause a blockage.

Cleaning and care

Cleaning the spray arms

Particles of food can get stuck in the spray arm jets and bearings. The spray arms should therefore be checked regularly (approx. every 4 - 6 months).

- Turn the dishwasher off.

Remove the spray arms as follows:

- Pull out the cutlery tray (if present).

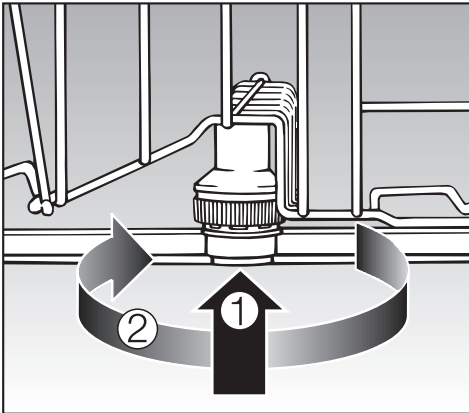

- Push the **upper** spray arm up to engage the inner ratchet and unscrew the spray arm.
- Lift the **middle** spray arm up ① to engage the ratchet and unscrew the spray arm ②.

- Remove the lower basket.

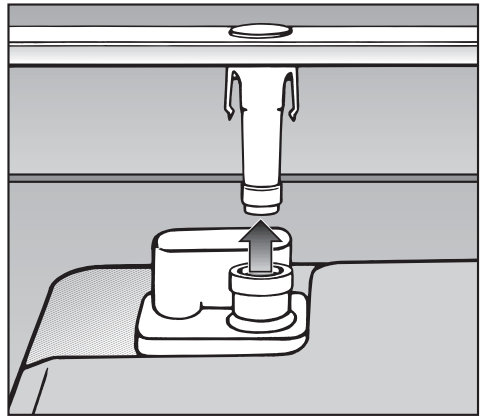

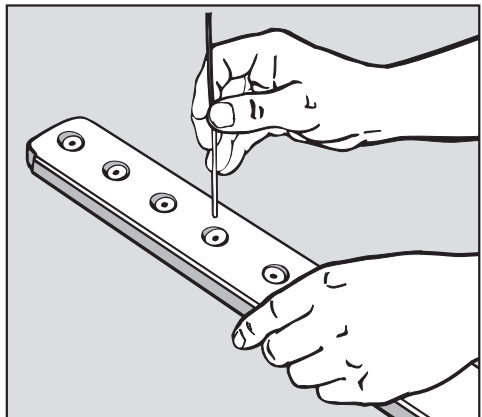

- Pull the **lower** spray arm firmly upwards to remove.





- Use a pointed object to push the food particles that are stuck in the spray arm jets into the spray arm.
- Rinse the spray arms thoroughly under running water.
- Replace the spray arms and check that they rotate freely.

Frequently asked questions



 Repairs should only be carried out by a qualified and trained person in accordance with local and national safety regulations. Unauthorized repairs could cause personal injury or machine damage.

Technical faults		
Problem	Possible fault	Solution
The dishwasher does not start.	The door is not properly closed.	Push the door firmly closed.
	The dishwasher is not plugged in.	Insert the plug.
	The circuit breaker has tripped.	<ul style="list-style-type: none">– Reset the circuit breaker. See the data plate for minimum amperage.– If the circuit breaker trips again, contact Miele.
	The dishwasher is not turned on.	Press the  button and select a program.
The dishwasher stops during a program.	The circuit breaker has tripped.	<ul style="list-style-type: none">– Reset the circuit breaker (see data plate for the correct fuse rating).– If the circuit breaker trips again, contact Miele.
The optical interface does not light up after program start.	The light guide was not installed correctly.	Install the light guide correctly (see the installation diagram).



Frequently asked questions

Problem	Possible fault	Solution
The optical interface flashes fast. The buzzer sounds. One of the following fault messages is displayed:		Before fixing the fault: – Press the  button to turn the dishwasher off.
 Fault FXX	There may be a technical fault.	After a few seconds: – Turn the dishwasher on. – Select the desired program. – Close the door. If the error message is displayed again, there is a technical fault. – Contact Miele.
 Waterproof	The waterproof system has activated.	– Turn off the water supply. – Contact Miele.







Frequently asked questions

Faults in the water intake or water drain		
Problem	Possible fault	Solution
<p>The optical interface flashes fast. The buzzer sounds. One of the following fault messages is displayed:</p>		
 Open the water supply	The water supply is closed.	Open the water supply all the way.
 Water intake		Before fixing the fault: <ul style="list-style-type: none"> – Press the  button to turn the dishwasher off.
	There is a problem with the water intake.	<ul style="list-style-type: none"> – Open the water supply all the way. – Check the screen in the water supply valve and clean it if necessary (see "User maintenance instructions"). – The water pressure at the water connection is less than 30 kPa (0.3 bar). Consult a plumber.

Frequently asked questions

Problem	Possible fault	Solution
<p>The optical interface flashes fast. The buzzer sounds. One of the following fault messages is displayed:  Water drain</p>	<p>Fault in the water drainage. There might be water in the wash cabinet.</p>	<p>Before fixing the fault:</p> <ul style="list-style-type: none">– Press the  button to turn the dishwasher off. <p>Fault in the water drainage:</p> <ul style="list-style-type: none">– Clean the triple filter system (see "Cleaning and care").– Clean the drain pump (see "User maintenance instructions").– Clean the non-return valve (see "User maintenance instructions").– Remove any kinks or high loops in the drain hose.

Frequently asked questions

General problems with the dishwasher		
Problem	Possible fault	Solution
The indicator lights and the display are dark. Only the indicator light  flashes slowly.	The indicators and the display turn off automatically to save energy (Standby).	Press the  button to come out of Standby mode.
The interior lighting does not come on when the door is opened.	The interior lighting was permanently turned off.	Turn the interior lighting back on (see "Additional options - BrilliantLight").
The following fault message is displayed:  Salt reservoir cover The buzzer sounds and the optical interface flashes during the program sequence.	The salt reservoir cover is not properly closed.	<ul style="list-style-type: none"> – Close the salt reservoir cover. If the salt reservoir cover opened during a program: <ul style="list-style-type: none"> – Push the  button to turn the dishwasher off (even if it appears to be off) and on again. – Re-start the program.
The buzzer sounds during the program. The following fault message is displayed:  Spray arm blocked	The middle spray arm is blocked by dishware.	Open the dishwasher door and rearrange items blocking the spray arms.
	The spray arm jets of the middle arm are clogged.	<ul style="list-style-type: none"> – Press the  button to turn the dishwasher off. Then: <ul style="list-style-type: none"> – Clean the spray arm (see "Cleaning and care").

Frequently asked questions

Problem	Possible fault	Solution
There are detergent residues in the dispenser at the end of a program.	The dispenser was wet when detergent was added.	Make sure the dispenser is dry before adding detergent.
The detergent dispenser cover will not close.	Detergent residue is blocking the latch.	Remove the detergent residue.
The inside of the door and/or the interior walls are wet after a program has finished.	This is normal!	None. The moisture evaporates after some time.
There is water in the wash cabinet at the end of a program.		Before fixing the fault: – Press the  button to turn the dishwasher off.
	The filter combination in the wash cabinet is clogged.	Clean the filter combination (see "Cleaning and care").
	The drain pump or non-return valve is blocked.	Clean the drain pump or the non-return valve (see "User maintenance instructions").
	There is a kink in the drain hose.	Remove the kink.
Some programs run for a long time.	No fault! Certain programs have a long runtime.	Select a different program (see "Program guide").
Although AutoOpen is selected, the door remains closed at the end of the Short program. Therefore the dishware is still moist.	No fault! Because of the program's short runtime, the AutoOpen function is not available for the Short program.	To improve the drying, raise the rinse temperature (see "Settings - High temp rinse").

Frequently asked questions

Noises		
Problem	Possible fault	Solution
There is a knocking noise in the wash cabinet.	A spray arm is hitting the dishware.	Interrupt the program and rearrange items blocking the spray arms.
There is a rattling noise in the wash cabinet.	Dishware is moving around in the wash cabinet.	Interrupt the program and rearrange loose pieces.
	A foreign object has become lodged in the drain pump.	Remove the foreign object from the drain pump (see: "Cleaning the drain pump and non-return valve")
There is a knocking noise from the water pipe	This may be caused by the installation or the diameter of the water pipe.	This has no effect on the functioning of the dishwasher. If in doubt, contact a plumber.

Frequently asked questions

Poor cleaning results		
Problem	Possible fault	Solution
The dishes are not clean.	The dishes were not loaded correctly.	See "Loading the dishwasher".
	The program was not suitable for the requirements.	Select a more suitable program (see "Program guide").
	Not enough detergent was dispensed.	Use more detergent, or switch to another detergent.
	The spray arms are blocked by dishware.	Check by turning the spray arms and rearrange the dishes if necessary.
	The filter combination in the wash cabinet is clogged or not correctly inserted. The spray arm jets might be clogged as a result.	Clean the filter combination or insert it correctly. Clean the spray arm jets, if necessary (see "Cleaning and care").
	The non-return valve is stuck in the open position. Dirty wash water will run back into the wash cabinet.	Clean the drain pump and the non-return valve (see "User maintenance instructions").
There are streaks on the glasses and cutlery. The glasses take on a bluish sheen; the deposits can be wiped off.	The rinse aid dosage is set too high.	Reduce the dosage (see "Settings - Rinse aid").

Frequently asked questions

Problem	Possible fault	Solution
Dishes are not dry, or glasses and cutlery are spotty.	The rinse aid dosage is set too low or the rinse aid reservoir is empty.	Refill the reservoir, increase the dosage, or switch the rinse aid product when refilling (see "Rinse aid").
	The dishes were taken out too soon.	Leave the dishes in longer (see "Use").
White residue is visible on the dishware. Clouding occurs on glassware and cutlery; the deposit can be wiped off.	The rinse aid dosage is too low.	Increase the dosage (see "Settings - Rinse aid").
	The salt reservoir is empty.	Refill the salt reservoir (see: "Before using for the first time - Filling the salt reservoir").
	The water softener setting is too low.	Increase the water softener setting (see "Settings - Water softener").

Frequently asked questions

Problem	Possible fault	Solution
Glasses have a brownish-blue discoloration; the deposit cannot be wiped off.	Detergent deposits.	Switch to another detergent right away.
Glasses are dull and discolored; the deposit cannot be wiped off.	The glasses are not dishwasher-safe. Surface changes occur.	There is no remedy. Use only dishwasher-safe glasses.
Tea or lipstick stains have not been completely removed.	The wash temperature of the selected program was too low.	Select a program with a higher wash temperature.
	The bleaching effect of the detergent is too low.	Switch to another detergent.
Plastic parts are discolored.	Natural dyes, e.g. from carrots, tomatoes or ketchup, may be the cause. Not enough detergent was used or the bleaching effect of the detergent is too low.	Use more detergent (see "Use - Detergent"). This discoloration is permanent.
There are rust stains on the cutlery.	The affected items are not corrosion resistant.	There is no remedy. Use only dishwasher-safe cutlery.
	No program was started after refilling salt. Salt residues entered the wash cycle.	Always start the "Pre-rinse" program without a load after refilling salt.

Cleaning the water supply screen

There is a screen in the screw connection of the water inlet hose to protect the water inlet valve. The screen must be cleaned when dirty, otherwise insufficient water will flow into the wash cabinet.

 The plastic housing of the water connection contains an electric valve. The housing must not be immersed in water.

Recommendation

If the water supply contains a large amount of insoluble substances, we recommend fitting a large-area filter between the tap and the water inlet hose.

This filter is available from Miele.

To clean the screen:

- Disconnect the dishwasher from the electric power supply. Always switch the appliance off before unplugging it.
- Turn off the water supply.
- Unscrew the water supply valve.



- Take the seal ring out of the screw connection.
- Use needlenose pliers to pull out the screen, then clean it.
- When removing the screen, take care not to pull out or displace the flow regulator behind it.
- Replace the screen and seal. Make sure they are positioned correctly.
- Reconnect the water supply valve to the tap. Make sure not to cross-thread the connection.
- Turn the water supply back on. If the connection leaks it might be too loose or cross-threaded. Unscrew and reconnect the water supply valve correctly.

User maintenance instructions

Cleaning the drain pump and non-return valve

If there is still some water in the wash cabinet at the end of a program, the water was not pumped out properly. The drain pump or the non-return valve might be clogged. However, they are easy to clean.

- Disconnect the dishwasher from the electrical power supply. Always turn the appliance off before unplugging it.
- Remove the triple filter system from the wash cabinet (see "Cleaning and care - Cleaning the filters").
- Scoop the water out of the cabinet using a small container.

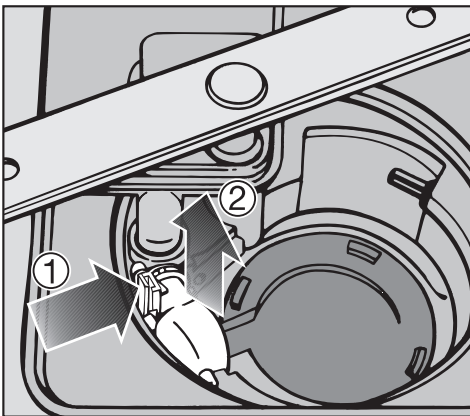

- Press the catch for the non-return valve inwards ①.
- Pull the non-return valve out ② and rinse it thoroughly under running water.
- Remove all foreign objects from the non-return valve.

The drain pump is located beneath the non-return valve (arrow).

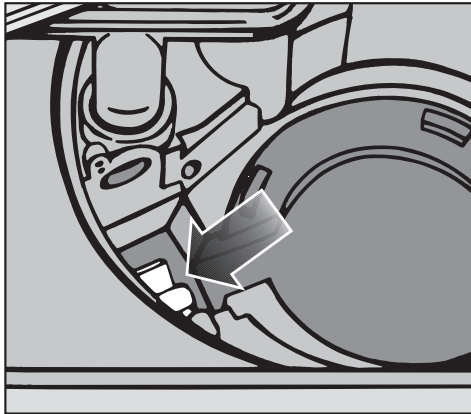

- Remove all foreign objects from the drain pump (glass splinters are particularly difficult to see). Turn the drain pump impeller by hand to check for objects. It is normal that the rotation of the impeller feels jerky.
- Carefully replace the non-return valve.

⚠ Make sure the catch engages correctly!

Be careful not to damage any components when cleaning the drain pump and the non-return valve.

Repairs

In the event of a fault which you cannot correct yourself please contact the Miele Service Department at the phone number on the back of this booklet.

- Please quote the model type and number of your appliance.

These can be found on the data plate along the right edge of the door.

PC Update

The Program Correction (PC) allows a technician to update the dishwasher to make use of new technology.

When, for example, technological developments offer advanced modifications to your existing program cycles a service technician will be able to input these into your machine controls via the indicator light marked PC. Miele will provide information when such possibilities become available.

Electrical connection

 All electrical work must be performed by a qualified service technician in accordance with local and national safety regulations.

- The electrical connection is made through a plug and outlet according to national requirements. The outlet has to be easily accessible after installation. This facilitates access for electrical safety checks, for example when the appliance is being repaired or serviced.
- If the appliance is hard wired, a multiple-pole circuit breaker must be installed. The contact opening at the main breaker must be at least 3 mm wide and lockable in the open position.
- If necessary, an equalization of the potentials must be carried out.
- A damaged power cord must only be replaced with a genuine Miele cord by a Miele service technician..
- For technical data, see the data plate or the attached wiring diagram.

The appliance must only be operated with the voltage, frequency and fuse rating shown on the **data plate**.

A **conversion** may only be performed according to the attached conversion diagram **and** wiring diagram.

Subsequent conversions may result in longer program runtimes and higher energy consumption. The specified label values are only met with the factory settings.

The **data plates** are at the back of the appliance and along the right edge of the open door.

The **wiring diagram** comes with the appliance.

The **conversion diagram** is attached to the base panel behind the plastic base cover.

Removing the base cover

The electrical terminal is located behind the front cover in the middle of the dishwasher base.

 Disconnect the dishwasher from the electrical power supply.

- Unscrew the 2 screws (left and right) and remove the base panel.
- Screw the base panel back on when work on the connection is finished.

Follow the installation diagram included with the dishwasher!

Grounding connection

The ground lead must be connected to the screw connection point (marked with the ground symbol \downarrow) at the back of the machine.

WARNING
THIS APPLIANCE MUST
BE GROUNDED

The PG 8083 SCVi comes equipped with a 14/3 AWG cord for connection to a standard AC 120 V, 60 Hz power outlet with a NEMA 5-15P plug or with a 10/4 AWG cord for connection to a 2N AC 208/240 V, 60 Hz power supply with a NEMA Type 14-30P plug.

	120V	208-240V
Rated Load (kW)	1.3	5.0
Fuse Rating	15A	30A

Plumbing

The Miele waterproof system

Providing the dishwasher was installed correctly by a qualified technician, the waterproof system will protect you from water damage throughout the lifetime of the machine.

Connection to the water inlet

This machine must be connected to the water supply in accordance with all national and local plumbing codes.

 Water in the machine is not suitable for drinking.

- The machine must be connected to the water supply in accordance with local and national regulations.
- The water being used should have drinking water quality. A high iron content can lead to rust at the items to be cleaned and at the machine.
- The water pressure (flow pressure at the water connection) must be between 4.35 and 145 psi. If the water pressure is lower, the message Water intake is displayed (see "Frequently asked questions"). If the water pressure is higher, a pressure reducer must be installed.

- Valves with 3/4" male thread are to be provided on site. Faucets and drain connections should be situated as close to the machine as possible, and be easily accessible.
- The water inlet hose is a pressure hose (DN 10) approx. 4' 11" (1.5 m) long with a 3/4" thread. A 1.5 m extension hose is available (flexible metal hose certified for a pressure of 2030 psi). The dirt screen and the flow regulator in the threaded water connection must not be removed.

 To prevent damage to the dishwasher, make sure all air has been bled from the supply line.

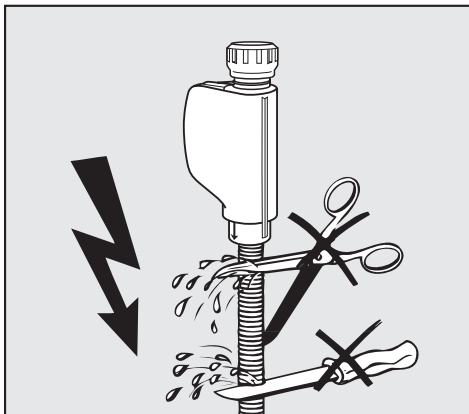

 The inlet hose must **not** be shortened or damaged in any way because it contains electrical wires (see illustration).

Water drainage

- The drain is equipped with a non-return valve which prevents waste water from flowing back into the dishwasher through the drain hose.
- The dishwasher drain hose should be connected to a **separate** drain for the dishwasher only.
If no separate drain is available, we recommend connecting it to a dual-chamber siphon.
- The flexible drain hose is 4' 7" (1.4 m) long and has an internal diameter of $\frac{7}{8}$ " (22 mm). Do not cut the drain hose.
Hose clamps are supplied for securing it into position.
- The on-site drain connection point should be located between 1 ft. (0.3 m) and 3' 3". (1 m) **above the lower edge of the machine**.
If it is lower than 1 ft. (0.3 m), bend the hose in a curve to a height of at least 1 ft. (0.3 m).
The drainage system must be able to take a minimum drainage flow of 4.5 gal/min (16 l/min).
- The drain hose must not be shortened.

 Make sure the hose is not kinked or pulled too tight.

See also the installation diagram supplied.

Venting the drainage system

The drain must be vented if the connection to the building's drainage system is lower than the roller guides for the lower basket in the door. Otherwise the water inside the dishwasher may siphon out during the wash program.

For venting:

- Open the dishwasher door completely.
- Pull the lower spray arm up to remove.

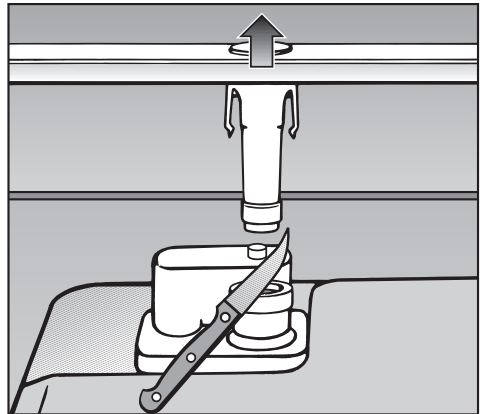

- Cut off the cover of the vent valve in the wash cabinet.

Technical data

Model

PG 8083 SCVi

Commercial dishwasher

Height	33 1/4" (84.5 cm) [adjustable +2 9/16" (6.5 cm)]
Installation height	min. 33 1/4" (84.5 cm) [+2 9/16" (6.5 cm)]
Width	23 3/16" (59.8 cm)
Installation width	23 5/8" (60 cm)
Depth	22 7/16" (57 cm)
Weight	127 lbs (57.5 kg)
Voltage	
Connected load	see data plate
Fuse rating	
Power consumption when off	0.30 W
Power consumption when not off	2.00 W
Water pressure (flow pressure)	4.35 - 145 psi
Cold or hot water supply	max. 140°F (60°C)
Water hardness	max. 37.5 gr/gal (36°d)
Drainage pumping height	max. 3' 3" (1 m)
Drain hose length	max. 13' 1 1/2" (4 m)
Power cord	approx. 6' (1.7 m)
Capacity	16 standard table settings
Noise emissions	
Sound power level LwA	49 dB (A)
Sound pressure level LpA	38 dB (A)
Manufacturer's address	Miele & Cie. KG, Carl-Miele-Str. 29, 33332 Gütersloh, Germany

General requirements for measuring noise

The dishwasher must be loaded with **16 place settings** and the **Normal** program must be used.

Installation requirements for measuring noise

The dishwasher must be installed as follows:.

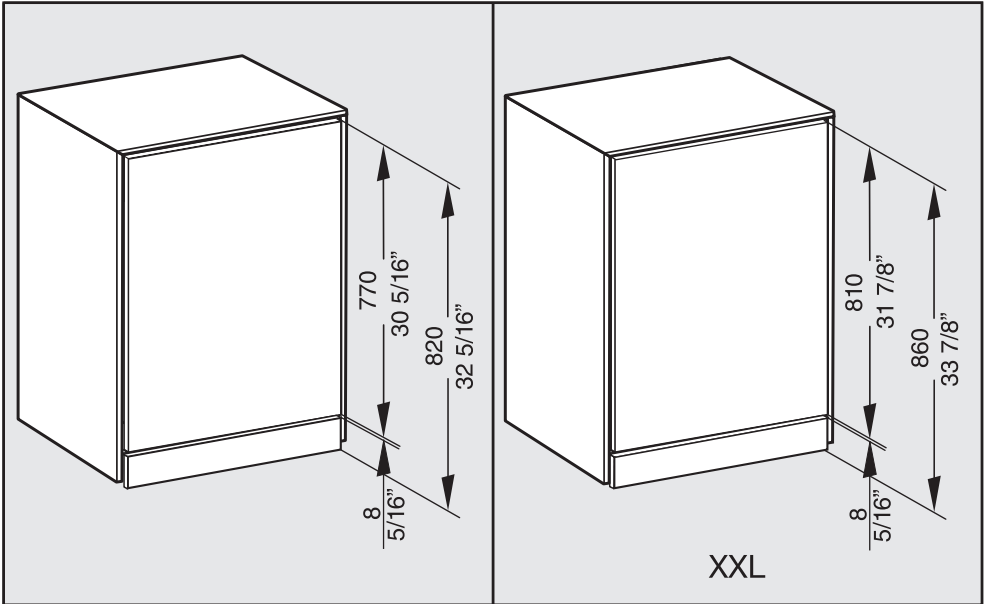

- Install the dishwasher into an appropriate housing unit.
- Secure the front panel.

Noise measurement

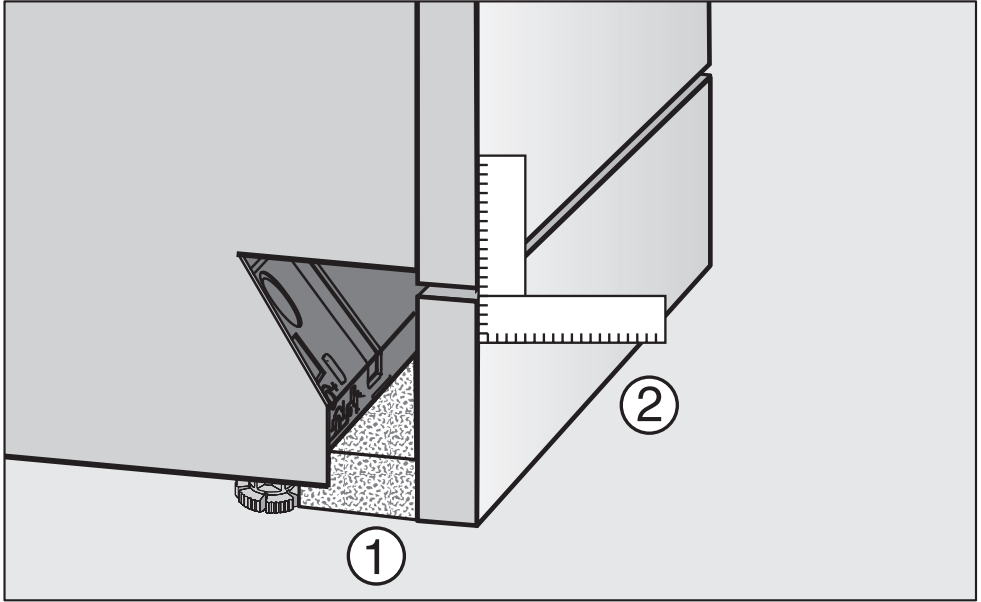

- Push the insulation mat supplied (depending on model) under the plinth until it is up against the appliance feet ①.
- Attach the toe-kick so that it is flush with the door front ②.

**Please have the model and serial number
of your appliance available before
contacting Technical Service.**



**U.S.A.
Miele, Inc.**

National Headquarters

9 Independence Way
Princeton, NJ 08540
Phone: 800-991-9380
609-419-9898
Fax: 609-419-4241
www.mieleusa.com

**Technical Service & Support
Nationwide**

Phone: 800-991-9380
Fax: 800-220-1348

proservice@mieleusa.com