

RH29H8000SR

29 cu. ft. Side-by-Side Refrigerator with Food ShowCase Fridge Door

Features

- Large Capacity – 29 cu. ft.
- Food ShowCase Fridge Door
- High-Efficiency LED Lighting
- External Filtered Water and Ice Dispenser
- Automatic In-Door Ice Maker
- Fingerprint Resistant Coating
- ENERGY STAR® Compliant
- Power Freeze and Power Cool Options
- Tempered Glass Shelves
- 2 Crisper Drawers

Convenience

- Cool Tight Door
- Dispenser Light
- Door Alarm
- Water Filter Indicator
- Child Lock



ENERGY STAR® Rated:
CEE Tier 1: More Efficient
(20% more efficient than Federal Standard)
740 kWh/yr



Food ShowCase Fridge Door



External Filtered Water and Ice Dispenser

Available Color



Stainless Steel

Signature Features

FOOD SHOWCASE FRIDGE DOOR

- Door-in-door storage gives you easy reach of key items that are most often used, all visible in one glance.

EXTRA LARGE CAPACITY

- Our 29 cu. ft. extra large capacity Side-by-Side has enough room to fit up to 29 bags of groceries.*

*Grocery comparison based on each cubic foot of usable space equaling one paper bag.

HIGH-EFFICIENCY LED LIGHTING

- High-efficiency design beautifully lights up the interior so you're able to quickly spot what you want.
- Sleek design saves more space than traditional incandescent light bulbs.



Ranked **“Highest in Customer Satisfaction with Refrigerators”**
by J.D. Power and Associates.

SAMSUNG

RH29H8000SR

29 cu. ft. Side-by-Side Refrigerator with Food ShowCase Fridge Door

Installing Your Refrigerator

1. Measure the height, width and depth of the opening, making sure to include baseboards, molding tile, countertop overhang, etc. Check to be sure there is enough room to open the door (consider walls, islands or other obstacles when measuring).
2. Refer to illustration below to determine dimensions.
3. Allow 2" of clearance on hinge side of refrigerator when installing next to a wall where handle may make contact.
4. Allow 1" minimum clearance at rear for proper air circulation and water/electrical connections. Allow a 3/8" minimum clearance at sides and top for ease of installation.
5. Ensure each door and entry way in the home is wide enough for the refrigerator to be moved through easily.

Please note: The following dimension and cutout information is for planning purposes only. For complete installation details consult manual packed with product, or download manual on-line at samsung.com.



Dimensions

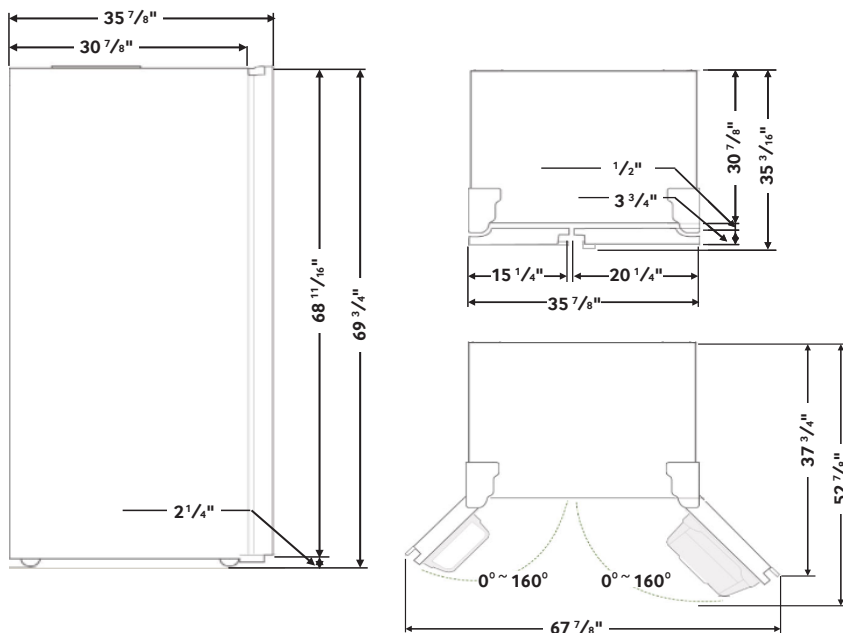

Total Capacity: 28.5 cu. ft.

Refrigerator: 18.4 cu. ft.

- Food ShowCase Fridge Door
 - 1 Tilting Door Bin
 - 4 Fixed Door Bins
- 2 Crisper Drawers
- 4 Tempered Glass Shelves
- 5 Door Bins
- LED Lighting

Freezer: 10.1 cu. ft.

- 4 Tempered Glass Shelves
- 2 Clear Drawers
- Automatic In-Door Ice Maker
- LED Lighting

Accessories

HAF-CIN/EXP Water Filter

Warranty

One (1) Year Parts and Labor on Refrigerator

Five (5) Years Parts and Labor on Sealed Refrigeration System Only*

Ten (10) Years Parts and Five (5) Years Labor on Digital Inverter Compressor

*Compressor, evaporator, condenser, drier, connecting tubing

Product Dimensions & Weight

Dimensions (WxHxD with hinges, handles and doors): 35 7/8" x 69 3/4" x 35 3/16"

Dimensions (WxHxD without hinges and door): 35 7/8" x 68 11/16" x 30 7/8"

Dimensions (WxHxD with hinge and door, no handle): 35 7/8" x 69 3/4" x 35 3/16"

Weight: 357.1 lbs.

Shipping Dimensions & Weight (WxHxD)

Dimensions: 38 1/4" x 75 3/16" x 39 3/16"

Weight: 388 lbs.

Color

Model #

UPC Code

Stainless Steel

RH29H8000SR

887276028811

SAMSUNG

Samsung received the highest numerical score for refrigerators in the proprietary J.D. Power and Associates 2012 Kitchen Appliance Study.SM Study based on 12,615 total responses measuring 17 brands and measures opinions of consumers about their refrigerator obtained new in the past 24 months. Proprietary study results are based on experiences and perceptions of consumers surveyed in January-February 2012. Your experiences may vary. Visit jdpower.com.

Actual color may vary. Design, specifications, and color availability are subject to change without notice. Non-metric weights and measurements are approximate.

©2014 Samsung Electronics America, Inc. 85 Challenger Road, Ridgefield Park, NJ 07660. Tel: 800-SAMSUNG. samsung.com. Samsung is a registered trademark of Samsung Electronics Co. Ltd.