



FRIEDRICH

1883

DUCTLESS SPLIT SYSTEMS

**ALL NEW LINE
FOR 2014**



THE EXPERTS IN ROOM AIR CONDITIONING

The Next Generation of Ductless Split Systems

Three indoor unit types.



WALL-MOUNTED
Cool only and heat pump models



CEILING CASSETTE
Heat pumps



CONCEALED DUCT
Heat pumps

All of the advantages of ductless systems and Friedrich quality.

ENERGY STAR® models

All Friedrich ductless models exceed the federal 13.0 SEER requirements. Of the 146 total possible single and multizone configurations, 102 models meet ENERGY STAR® published minimums with SEERS up to 25.0 and EERs up to 14.0.

Inverter variable capacity advantages

Inverter technology allows each system to adjust capacity and cooling output to provide only the amount of cooling needed at a given time. For example, an 18000 Btu system will operate even more efficiently at 15500 Btu or less if that's all that's needed, reducing energy consumption and improving comfort.

Optimized airflow

The indoor unit's 4-way air swing quickly disperses cool air to all four corners of the room to provide comfort throughout the room within a few minutes. The 'Air Burst' feature moves air at an even higher speed for rapid cooling.

Zero duct loss

The DOE reports that ducted systems lose an average of 25-40% in performance due to leaks, cracks or disconnections in ductwork. No ductwork means that ductless systems do not experience duct loss, saving energy and money.

Zone cooling flexibility

Independently condition up to (4) separate zones using only a single outdoor unit. Achieve the ultimate in comfort and energy control by cooling or heating only the zones that are in use. And, because each zone is independent of the others, comfort settings can vary.

No dirty air ducts*

Now there's no need to clean dirty air ducts that can harbor dust, germs and allergens that are eventually blown into your home or office.

Friedrich has up to 131 multizone configurations utilizing wall-mounted, ceiling cassette and concealed duct models.

Zone Cooling and Heating

Occupants have the ability to set the temperature of each zone to their preferred comfort level. The system will run as needed to maintain desired temperature.

Occupants may also turn off units in unoccupied rooms without affecting other zones.

That's the beauty- and efficiency of a Friedrich multizone system.

Enjoy the flexibility to mix and match wall-mounted, ceiling cassette and concealed duct systems to fit your application.



Friedrich's highest energy efficiencies ever. Up to 25.0 SEER

DIAMON GOLD
Advanced Corrosion Protection™

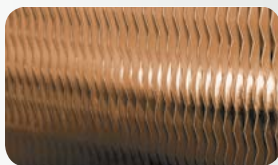

Protects the outdoor coil against deterioration and extends the life of the unit especially in harsh coastal environments.

*Ductless wall-mounted and ceiling cassette models



No other system matches the efficiency and performance of Friedrich's Precision Inverter™

CONVENTIONAL SYSTEMS run at a single capacity, turning on and off to reach the desired set point. This means they run at full speed each time, resulting in high energy consumption.

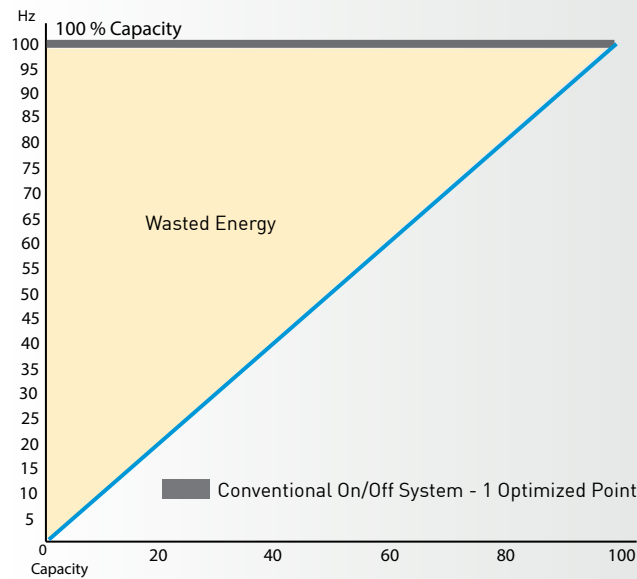

TWO-STAGE AIR CONDITIONERS won't significantly reduce your energy use. These units only run at 2 speeds, 50% and 100%, also resulting in high energy consumption.

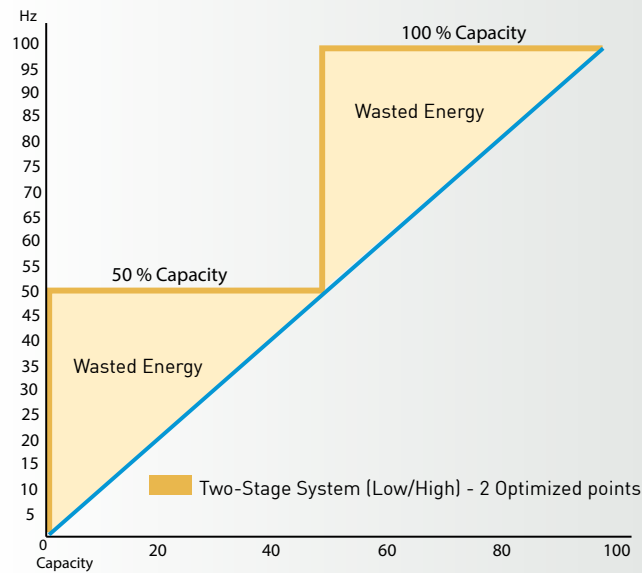

TYPICAL INVERTER SYSTEMS make changes in 7Hz increments allowing the unit to run at variable speeds, delivering a more precise heating-cooling solution.

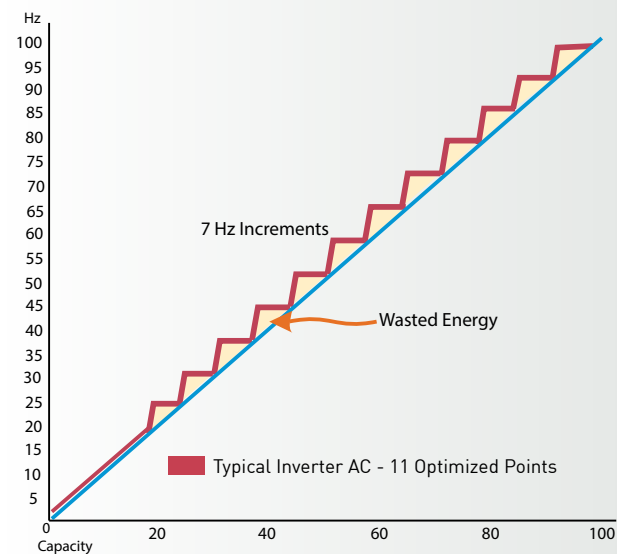

Friedrich's Precision Inverter™ accomplishes better energy efficiency by using 1Hz increments.

This allows the unit to produce only the output necessary to reach the desired temperature. The result is optimal performance and increased energy efficiency.

Inverter technology varies the compressor, the outdoor and the indoor fan speeds, eliminating constant compressor start-ups/shut-downs that traditional systems require to maintain the set temperature.

This is especially beneficial in multizone systems where room temperature set points vary and some indoor units may be turned off in unoccupied rooms.



Each system can adjust capacity and cooling output to provide only the amount of cooling needed at a given time. The result is optimal comfort with low energy costs.

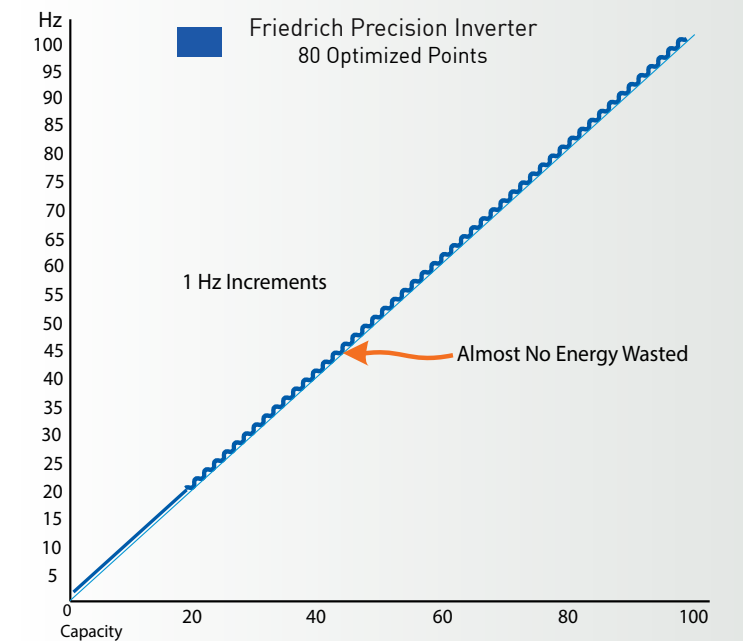

The Advantages of Friedrich's Precision Inverter System

TRADITIONAL SYSTEM	INVERTER SYSTEM
At initial start up, fixed capacity system slowly reaches the set temperature.	At initial start up, utilizes variable capacity to quickly reach the set temperature.
Complete shutdown once set temperature is achieved.	Reduces capacity as set temperature is achieved.
Temperature within the space rises until 2nd system start up.	Variable capacity maintains set temperature keeping space comfortable with reduced energy consumption.
System works at full capacity to again reach set temperature.	
System cycles on and off continually to maintain the set temperature.	

Attractive and high efficiency options for cooling and heating residential and light commercial spaces.



Wall-mounted models mount high on the wall.

The attractive, neutral finish blends well with just about any decor.



Residential Applications

- Room additions/renovations
- Homes without ductwork
- Bedrooms and family rooms
- Garage workshops
- Sunrooms
- Guest quarters
- Wine cellars

Commercial Applications

- Hotels and other lodging
- Computer rooms/server rooms
- Restaurant kitchen and prep areas
- Offices in warehouse spaces
- Storage facilities
- Buildings where security concerns prevent the use of window units
- Internal areas without exterior wall access



Indoor units can be used individually or as part of a multizone system to condition multiple spaces or a large area.

Features you'll find with Friedrich Ductless Systems:

System Type	Wall-mounted Single Zone	Wall-mounted Multizone	Cassette Single Zone	Cassette Multizone	Concealed Duct Single Zone	Concealed Duct Multizone
Installation	Wall	Wall	Ceiling	Ceiling	Ceiling	Ceiling
Cool only	Y	N	N	N	N	N
Heat pump	Y	Y	Y	Y	Y	Y
115 volt models	Y	N	N	N	N	N
Inverter compressor	Y	Y	Y	Y	Y	Y
SEER	Up to 25.0	Up to 21.7	Up to 19	Up to 16.5	Up to 17.6	Up to 16.5
Auto changeover	Y	N	Y	N	Y	N
Low ambient operation*	Y	Y	Y	Y	Y	Y
24- Hr. Programmable timer	Y	Y	Y	Y	N	N
Remote control	Y	Y	Y	Y	N	N
Wall controller option	Y	Y	Y	Y	Y	Y
7-Day Programmability (with wall control)	Y	Y	Y	Y	Y	Y
Auto restart when power is interrupted	Y	Y	Y	Y	Y	Y
Continuous 'Air Sweep'	Y	Y	Y	Y	N	N
Washable, antimicrobial air filters	Y	Y	Y	Y	Y	Y
Auto shut flaps when unit is off	Y	Y	Y	Y	N	N
Louver Position (Fan/Cool/Heat)	6 / 6 / 6	6 / 6 / 6	4 / 5 / 4	4 / 5 / 4	N	N

*Refer to specification tables for low ambient capabilities.

Powerful airflow for faster heating and cooling.

Optimum air flow

Air is directed downward in heating mode and angled upward during cooling mode so the room feels more comfortable, faster.

Large fans

Powerful fans move the air across the room—up to 39 feet away. That means faster cooling and heating and you feel comfortable sooner no matter where you are in the room.

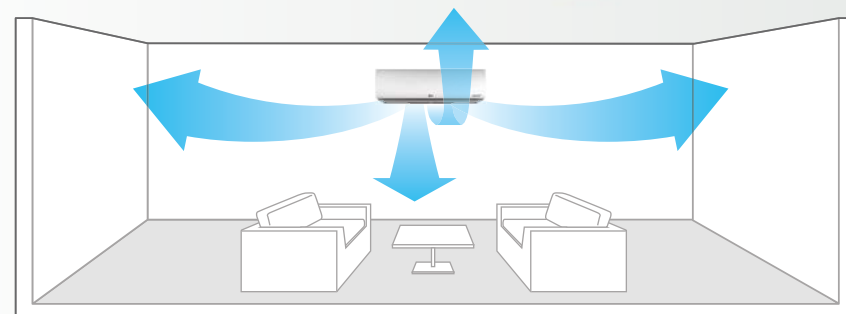
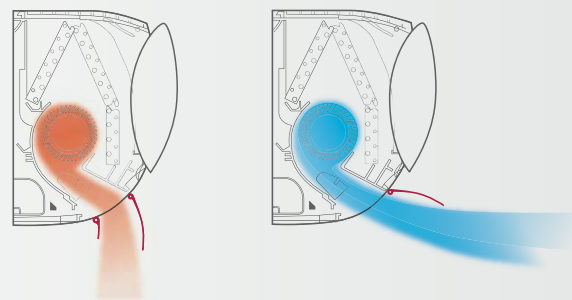

Features you'll find with Friedrich Ductless Systems:

DiamonGold Advanced Corrosion Protection™

Protects the outdoor coil against deterioration and extends the life of the unit especially in harsh coastal environments.

Auto dry

Indoor blower runs to dry out indoor coil after system is shutdown.

Surge cool/heat

Allows quick cooling/heating. In this mode the unit will operate at 100% for 30 minutes to cool/heat the room rapidly.

Dehumidifying mode

The system will adjust set point for maximum dehumidification.

Auto restart

Auto restart function allows system to resume with previous settings in the event of a power shutdown. (Power supply must be restored)

Auto changeover

When this function is selected system will adjust between Cooling and Heating mode based on room temperature

Built-in low ambient standard

Allows unit's operation down to 14°F in cooling mode.

4-Way auto swing

Louvers will automatically move up/down and left /right to maintain a uniform room temperature.

Friedrich's ductless line incorporates a cross-flow fan and a low vibration compressor to provide ultra quiet operation.

Ultra quiet cross-flow fan

The cross-flow design of the indoor fan creates an ultra quiet, yet powerful air flow into the room.

Low vibration, twin-rotary compressor

Friedrich's twin-rotary compressor has a unique design that reduces vibration for reduced sound levels outdoors.

BLDC fan motor

With accurate speed control that makes the electrical and mechanical operation smoother.

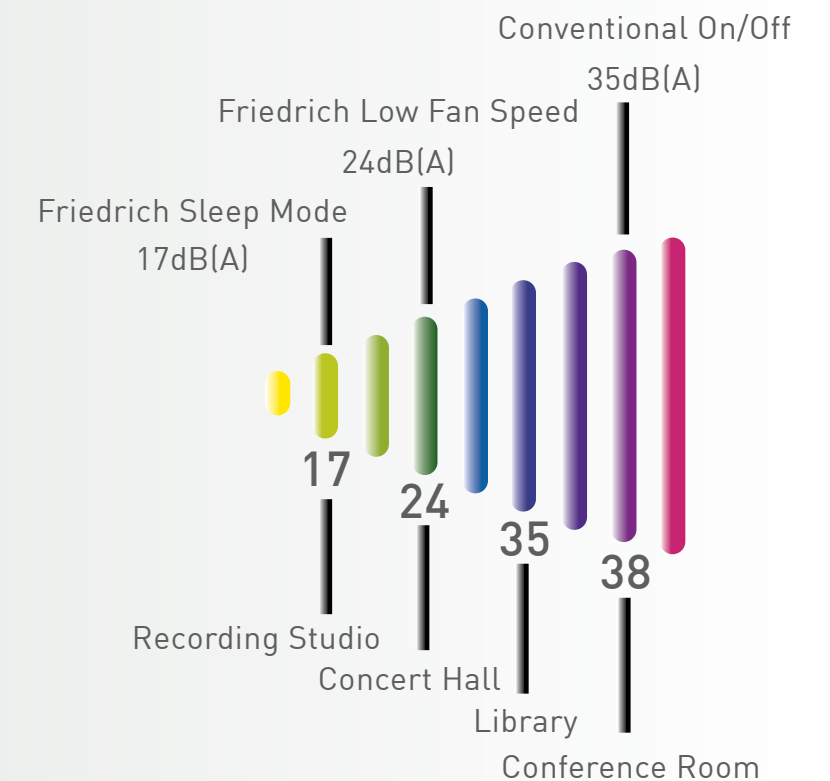

EASE OF INSTALLATION

New ductless line with convenient installation features that will get your ductless running in no time.

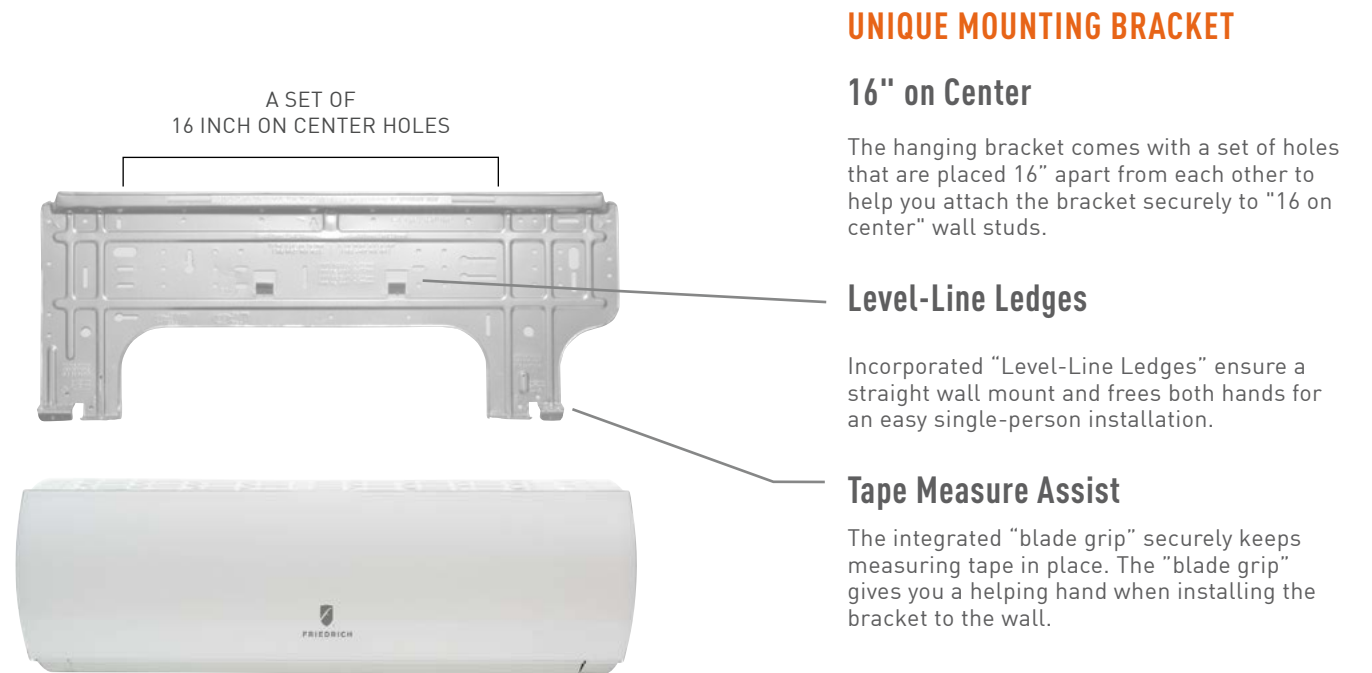

UNIQUE MOUNTING BRACKET

16" on Center

The hanging bracket comes with a set of holes that are placed 16" apart from each other to help you attach the bracket securely to "16 on center" wall studs.

Level-Line Ledges

Incorporated "Level-Line Ledges" ensure a straight wall mount and frees both hands for an easy single-person installation.

Tape Measure Assist

The integrated "blade grip" securely keeps measuring tape in place. The "blade grip" gives you a helping hand when installing the bracket to the wall.



Wall Standoff Bracket

The clip keeps sufficient space between the unit and the wall creating more room for installation.

Spacious Tubing Area

Ample space was created to facilitate tubing installation and placement.

Low Installation Access Panel

By lowering the access panel to eye-level we have created a hassle-free access to electrical connections.



Secure Grip Screws

"Grip Screws" firmly secure wall-mounted unit to wall bracket providing a stable setup.

OPTIONAL ACCESSORIES

Refrigeration Line Sets

USED WITH	Length Ft.	Liquid	Suction	Kit#
9000 and 12000 Btu indoor units	15'	1/4"	3/8"	T32150
	35'	1/4"	3/8"	T32350
18000 BTU indoor units	15'	1/4"	1/2"	T42150
	35'	1/4"	1/2"	T42350
24000, 30000 and 36000 Btu indoor units	15'	3/8"	5/8"	T53150
	35'	3/8"	5/8"	T53350

Low Ambient Wind Baffle Kit

Wind baffle allows operation down to 0 degrees Fahrenheit (Available for Wall-Mounted Single Zone)

WIND BAFFLE	USED WITH
DLAWB1	9000 - 12000 Btu wall-mounted single zone models
DLAWB2	18000 - 36000 Btu wall-mounted single zone models

Thermostat

DWC1-Wired Wall Thermostat (Available for all models)

Ceiling Cassette Grilles

Required decorative grille for ceiling cassette models

DECORATIVE GRILLE	USED WITH
DCG1218	MC24Y3J- 24000 Btu model
DCG2436	MC36Y3J- 36000 Btu model

Friedrich's Ductless Split systems are compatible with aftermarket drain pumps and condensate sensors.

For more information visit the following sites:

Condensate Pumps

Rectorseal/Aspen Pumps: <http://airtec.rectorseal.com/pumpselector>.

Condensate Sensors

Rectorseal, Safe-T-Switch® SS610E: www.rectorseal.com

Aqua guard, AG-9300-U: www.rctus.com/product

Adapter

Adapter part number 67270018 is available through Friedrich parts distributors.

All R410A models have 1/2"-20 UNF (5/16" SAE) X 1/4" SAE thread per inch charging and vacuuming ports. An adapter must be used for 1/4" gauges.



Single Zone

WALL-MOUNTED COOL ONLY

9000-24000 Btu. Cool only models with features for convenient operation, care-free comfort and years of dependability.

Features

- Inverter technology (variable speed compressor)
- High efficiency for low operating cost
- DiamonGold Advanced Corrosion Protection™
- Auto dry indoor coil
- Cooling/Fan mode
- Surge cool
- Natural air flow
- 4-Way auto swing
- Ultra quiet operation
- Sleep mode
- Dehumidifying mode
- Auto restart
- Built-in low ambient standard, down to 14°F (Cooling Mode)
- 24-hour on-off timer
- Condensate sensor connection
- Multiple ease of installation features (see p.10)



MW09C1J, MW12C1J



MW18C3J, MW24C3J



MR09C1J, MR12C1J



MR18C3J



MR24C3J



SPECIFICATIONS

PERFORMANCE RATINGS	Single Wall Mounted - Cool Inv				
		9k	12k	18k	24k
SYSTEM MODEL NO.		M09CJ	M12CJ	M18CJ	M24CJ
INDOOR MODEL		MW09C1J	MW12C1J	MW18C3J	MW24C3J
OUTDOOR MODEL		MR09C1J	MR12C1J	MR18C3J	MR24C3J
SPECIFICATIONS					
CAPACITY COOLING (RATED)	Btu	9,000	11,200	17,000	22,000
CAPACITY COOLING (MIN-MAX)	Btu	3,070~12,120	3,070~13,660	3,070~20,470	3,070~26,270
CAPACITY HEATING (RATED)	Btu	N/A	N/A	N/A	N/A
CAPACITY HEATING (MIN-MAX)	Btu	N/A	N/A	N/A	N/A
COOLING AMPS		6	8.4	7	8.7
HEATING AMPS		N/A	N/A	N/A	N/A
SENSIBLE HEAT RATIO		.89	.83	.79	.81
SEER		21.5	21.5	18.0	20.0
EER		13.3	12.5	12.0	10.8
HSPF		N/A	N/A	N/A	N/A
ENERGY STAR		YES	YES	YES	No
MOISTURE REMOVAL	Pts/h	2.6	3.0	5.3	6.0
AIRFLOW (QUIET, LOW, MED, HIGH)	CFM	124/212/272/335	124/212/272/335	300/399/509/622	300/424/629/742
SOUND RATING - INDOOR	dB-A	19 / 24 / 33 / 38	19 / 24 / 33 / 39	29 / 35 / 40 / 45	29 / 35 / 40 / 46
SOUND RATING - OUTDOOR	dB-A	45	45	53	54
OPERATING RANGE WIND BAFFLE)	°F	14(0)~118	14(0)~118	14(0)~118	14(0)~118
OPERATING RANGE (HEATING)	°F	N/A	N/A	N/A	N/A
EST. YEARLY OPERATING COST	\$	61	81	127	183
ELECTRICAL DATA					
POWER SOURCE	V	115/60/1	115/60/1	208/230/60/1	208/230/60/1
MINIMUM AMPACITY	A	12	12	19	19
COOLING WATTS	W	677	896	1416	2037
MAX. TD FUSE/BREAKER	A	20	20	25	25
POWER AND COMMUNICATION CABLE	No. x AWG	4 x 18	4 x 18	4 x 18	4 x 18
REFRIGERATION SYSTEM					
REFRIGERANT		R410A	R410A	R410A	R410A
COMPRESSOR TYPE		Inverter	Inverter	Inverter	Inverter
CONNECTIONS		Flare	Flare	Flare	Flare
LIQUID LINE O.D.	in	1/4	1/4	1/4	3/8
SUCTION LINE O.D.	in	3/8	3/8	1/2	5/8
FACTORY PRECHARGE	ft	41	41	25	25
REFRIGERANT CHARGE	oz	36	36	48	64
MIN./MAX. LINE LENGTH	ft	7~66	7~66	10~66	10~98
MAX. HEIGHT DIFFERENCE	ft	33	33	33	49
DIMENSIONS & WEIGHT					
INDOOR UNIT					
W X H X D	in	35-1/4x 11-1/4x 8-5/16	35-1/4x 11-1/4x 8-5/16	40-5/8x 12-7/8x 9-5/8	40-5/8x 12-7/8x 9-5/8
NET WEIGHT	lbs	23	23	31	32
SHIPPING WEIGHT	lbs	27	27	35	37
OUTDOOR UNIT					
W X H X D	in	30-5/16x 21-5/16x 11-5/16	30-5/16x 21-5/16x 11-5/16	34-5/16x 25-7/8x 12-5/8	34-5/16 x 31-1/2 x 12-5/8
NET WEIGHT	lbs	75	75	108	122
SHIPPING WEIGHT	lbs	79	79	115	130
TOTAL NET WEIGHT	lbs	97	97	139	154
TOTAL SHIPPING WEIGHT	lbs	106	106	150	167

Your operating costs will depend on your utility rates and use. The estimated operating cost is based on a electricity cost of \$.115 per kWh. For more information, visit www.ftc.gov/energy.

Due to continuing research in new energy-saving technology, specifications are subject to change without notice.



Single Zone

25.0 SEER WALL-MOUNTED HEAT PUMP

12000 Btu. Our most efficient unit ever! Features for comfort and convenience year 'round. In heating mode, unit efficiently heats by using approximately 1/4 of the energy required by electric heat.

Features

- Inverter technology (variable speed compressor)
- High efficiency for low operating cost
- DiamondGold Advanced Corrosion Protection™
- Auto dry indoor coil
- Surge Cool/Heat
- Natural air flow
- Ultra quiet operation
- Sleep mode
- Auto restart
- Auto changeover
- BLDC Motor
- Low ambient operation down to 14°F (Cooling Mode)
- 24-hour on-off timer
- ENERGY STAR® qualified model
- Hidden display (only visible during operation)
- Multiple ease of installation features (see p.10)



MWH12Y3J



MRH12Y3J



SPECIFICATIONS

PERFORMANCE RATINGS		Single Wall Mounted - H/P Inv (High SEER)
		12k
SYSTEM MODEL NO.		HM12YJ
INDOOR MODEL		MWH12Y3J
OUTDOOR MODEL		MRH12Y3J
SPECIFICATIONS		
CAPACITY COOLING (RATED)	Btu	12,000
CAPACITY COOLING (MIN-MAX)	Btu	3070~14660
CAPACITY HEATING@17°F (RATED)	Btu	13,600
CAPACITY HEATING (MIN-MAX)	Btu	3070~20470
COOLING AMPS		3.8
HEATING AMPS		4.3
SENSIBLE HEAT RATIO		.84
SEER		25.0
EER		14.0
HSPF		11.0
ENERGY STAR		Yes (Most Efficient)
MOISTURE REMOVAL	Pts/h	1.7
AIRFLOW (QUIET, LOW, MED, HIGH)	CFM	177 / 283 / 417 / 494
SOUND RATING - INDOOR	dB-A	42 / 36 / 25 / 17
SOUND RATING - OUTDOOR	dB-A	51
OPERATING RANGE (COOLING)	°F	14~118
OPERATING RANGE (HEATING)	°F	14~75
EST. YEARLY OPERATING COST	\$	77
ELECTRICAL DATA		
POWER SOURCE	V	208/230/60/1
MINIMUM AMPACITY	A	10
COOLING WATTS	W	857
HEATING WATTS	W	960
MAX. TD FUSE/BREAKER	A	15
POWER AND COMMUNICATION CABLE	No. x AWG	4 x 18
REFRIGERATION SYSTEM		
REFRIGERANT		R410A
COMPRESSOR TYPE		Twin Rotary
CONNECTIONS		Flare
LIQUID LINE O.D.	in	1/4
SUCTION LINE O.D.	in	3/8
FACTORY PRECHARGE	ft	25
REFRIGERANT CHARGE	oz	44
MIN./MAX. LINE LENGTH	ft	10~49
MAX. HEIGHT DIFFERENCE	ft	23
DIMENSIONS & WEIGHT		
INDOOR UNIT		
W X H X D	in	34-7/16 x 11-5/8 x 9-1/4
NET WEIGHT	lbs	25
SHIPPING WEIGHT	lbs	29
OUTDOOR UNIT		
W X H X D	in	34-5/16 x 25-7/8 x 12-5/8
NET WEIGHT	lbs	95
SHIPPING WEIGHT	lbs	100
TOTAL NET WEIGHT	lbs	119
TOTAL SHIPPING WEIGHT	lbs	128

Your operating costs will depend on your utility rates and use. The estimated operating cost is based on a electricity cost of \$.115 per kWh. For more information, visit www.ftc.gov/energy.

Due to continuing research in new energy-saving technology, specifications are subject to change without notice.



Single Zone

WALL-MOUNTED HEAT PUMPS

9000-18000 Btu. Features for comfort and convenience year 'round. In heating mode, units efficiently heat by using approximately 1/4 of the energy required by electric heat.

Features

- Inverter technology (variable speed compressor)
- High efficiency for low operating cost
- DiamonGold Advanced Corrosion Protection™
- Auto dry indoor coil
- Cooling/Heating/Fan mode
- Surge Cool/Heat
- Natural air flow
- 4-Way auto swing
- Ultra quiet operation
- Sleep mode
- Dehumidifying mode
- Auto restart
- Auto changeover
- Built-in low ambient standard, down to 14°F (Cooling Mode)
- 24-hour on-off timer
- Condensate sensor connection
- Multiple ease of installation features (see p.10)



MW09Y3J, MW12Y3J



MW18Y3J



MR09Y3J, MR12Y3J



MR18Y3J



SPECIFICATIONS

PERFORMANCE RATINGS	Single Wall Mounted - H/P Inv			
		9k	12k	18k
SYSTEM MODEL NO.		M09YJ	M12YJ	M18YJ
INDOOR MODEL		MW09Y3J	MW12Y3J	MW18Y3J
OUTDOOR MODEL		MR09Y3J	MR12Y3J	MR18Y3J
SPECIFICATIONS				
CAPACITY COOLING (RATED)	Btu	9,000	11,200	17,000
CAPACITY COOLING (MIN-MAX)	Btu	3,070-12,620	3,070-14,660	3,070-20,470
CAPACITY HEATING @17°F (RATED)	Btu	10,800	13,300	20,200
CAPACITY HEATING (MIN-MAX)	Btu	3,070-17,060	3,070-20,470	3,070-30,700
COOLING AMPS		3	4.2	7
HEATING AMPS		3.7	4.9	7.8
SENSIBLE HEAT RATIO		.88	.81	.78
SEER		21.5	21.5	18.0
EER		13.3	12.5	12.0
HSPF		11.0	11.0	9.7
ENERGY STAR		YES	YES	YES
MOISTURE REMOVAL	Pts/h	2.6	3.0	5.3
AIRFLOW (QUIET, LOW, MED, HIGH)	CFM	124/212/272/335	124/212/272/335	300/399/509/622
SOUND RATING - INDOOR	dB-A	19 / 24 / 33 / 38	19 / 24 / 33 / 39	29 / 35 / 40 / 45
SOUND RATING - OUTDOOR	dB-A	45	45	53
OPERATING RANGE (COOLING)(WIND BAFFLE)	°F	14(0)-118	14(0)-118	14(0)-118
OPERATING RANGE (HEATING)	°F	-4-75	-4-75	-4-75
EST. YEARLY OPERATING COST	\$	61	81	127
ELECTRICAL DATA				
POWER SOURCE	V	208/230/60/1	208/230/60/1	230/208/60/1
MINIMUM AMPACITY	A	10	10	19
COOLING WATTS	W	677	896	1416
MAX. TD FUSE/BREAKER	A	15	15	20
POWER AND COMMUNICATION CABLE	No. x AWG	4 x 18	4 x 18	4 x 18
REFRIGERATION SYSTEM				
REFRIGERANT		R410A	R410A	R410A
COMPRESSOR TYPE		Inverter	Inverter	Inverter
CONNECTIONS		Flare	Flare	Flare
LIQUID LINE O.D.	in	1/4	1/4	1/4
SUCTION LINE O.D.	in	3/8	3/8	1/2
FACTORY PRECHARGE	ft	41	41	25
REFRIGERANT CHARGE	oz	36	36	48
MIN./MAX. LINE LENGTH	ft	7-66	7-66	10-66
MAX. HEIGHT DIFFERENCE	ft	33	33	33
DIMENSIONS & WEIGHT				
INDOOR UNIT				
W X H X D	in	35-1/4 x 11-1/4 x 8-1/4	35-1/4 x 11-1/4 x 8-1/4	40-5/8 x 12-7/8 x 9-5/8
NET WEIGHT	lbs	23	23	31
SHIPPING WEIGHT	lbs	27	27	36
OUTDOOR UNIT				
W X H X D	in	30-5/16x21-5/16x11-5/16	30-5/16x21-5/16x11-5/16	34-5/16x25-7/8x12-5/8
NET WEIGHT	lbs	75	75	108
SHIPPING WEIGHT	lbs	79	79	115
TOTAL NET WEIGHT	lbs	98	98	139
TOTAL SHIPPING WEIGHT	lbs	107	107	150

Your operating costs will depend on your utility rates and use. The estimated operating cost is based on a electricity cost of \$.115 per kWh. For more information, visit www.ftc.gov/energy.

Due to continuing research in new energy-saving technology, specifications are subject to change without notice.



Single Zone

WALL-MOUNTED HEAT PUMPS

24000-36000Btu. Extensive features for comfort and convenience year 'round. In heating mode, units efficiently heat by using approximately 1/4 of the energy required by electric heat.

Features

- Inverter technology (variable speed compressor)
- High efficiency for low operating cost
- DiamonGold Advanced Corrosion Protection™
- Self-cleaning indoor coil
- Cooling/Heating/Fan mode
- Surge Cool/Heat
- Natural air flow
- 4-Way auto swing
- Ultra quiet operation
- Sleep mode
- Dehumidifying mode
- Auto restart
- Auto changeover
- Built-in low ambient standard, down to 14°F (Cooling Mode)
- 24-hour on-off timer
- Condensate sensor connection
- Multiple ease of installation features (see p.10)



MW24Y3J, MW30Y3J, MW36Y3J



MR24Y3J, MR30Y3J, MR36Y3J

SPECIFICATIONS

PERFORMANCE RATINGS	Single Wall Mounted - H/P Inv			
	24k	30k	36k	
SYSTEM MODEL NO.	M24YJ	M30YJ	M36YJ	
INDOOR MODEL	MW24Y3J	MW30Y3J	MW36Y3J	
OUTDOOR MODEL	MR24Y3J	MR30Y3J	MR36Y3J	
SPECIFICATIONS				
CAPACITY COOLING (RATED)	Btu	22,000	30,000	33,000
CAPACITY COOLING (MIN-MAX)	Btu	3,070-30,030	3,070-34,000	3,070-34,000
CAPACITY HEATING @17°F (RATED)	Btu	27,600	32,000	35,200
CAPACITY HEATING (MIN-MAX)	Btu	3,070-38,898	3,070-38,900	3,070-38,900
COOLING AMPS		7.9	13.4	17.0
HEATING AMPS		10.7	13.9	16.2
SENSIBLE HEAT RATIO		.66	.61	.67
SEER		21.0	18.5	16.5
EER		12.5	10.0	8.2
HSPF		11.0	10.0	10.0
ENERGY STAR		YES	No	No
MOISTURE REMOVAL	Pts/h	6.8	10.7	10.7
AIRFLOW (QUIET, LOW, MED, HIGH)	CFM	300/389/512/600	459/530/706/848	459/530/706/848
SOUND RATING - INDOOR	dB-A	33 / 39 / 43 / 46	33 / 39 / 44 / 49	37 / 40 / 44 / 49
SOUND RATING - OUTDOOR	dB-A	54	55	55
OPERATING RANGE (COOLING)(WIND BAFFLE)	°F	14(0)-118	14(0)-118	14(0)-118
OPERATING RANGE (HEATING)	°F	-4-75	-4-75	-4-75
EST. YEARLY OPERATING COST	\$	158	270	395
POWER AND COMMUNICATION CABLE	No. x AWG	4 x 18	4 x 18	4 x 18
ELECTRICAL DATA				
POWER SOURCE	V	208/230/60/1	208/230/60/1	230/208/60/1
MINIMUM AMPACITY	A	19	19	19
COOLING WATTS	W	1760	3000	4024
MAX. TD FUSE/BREAKER	A	25	25	25
REFRIGERATION SYSTEM				
REFRIGERANT		R410A	R410A	R410A
COMPRESSOR TYPE		Inverter	Inverter	Inverter
CONNECTIONS		Flare	Flare	Flare
LIQUID LINE O.D.	in	3/8	3/8	3/8
SUCTION LINE O.D.	in	5/8	5/8	5/8
FACTORY PRECHARGE	ft	25	25	25
REFRIGERANT CHARGE	oz	78	78	78
MIN./MAX. LINE LENGTH	ft	10-164	10-164	10-164
MAX. HEIGHT DIFFERENCE	ft	98	98	98
DIMENSIONS & WEIGHT				
INDOOR UNIT				
W X H X D	in	46-7/8 x 13-5/8 x 10-3/8	46-7/8 x 13-5/8 x 10-3/8	46-7/8 x 13-5/8 x 10-3/8
NET WEIGHT	lbs	40	40	40
SHIPPING WEIGHT	lbs	46	46	46
OUTDOOR UNIT				
W X H X D	in	34-5/16 x 31-1/2 x 12-5/8	34-5/16 x 31-1/2 x 12-5/8	34-5/16 x 31-1/2 x 12-5/8
NET WEIGHT	lbs	108	108	108
SHIPPING WEIGHT	lbs	115	115	115
TOTAL NET WEIGHT	lbs	148	148	148
TOTAL SHIPPING WEIGHT	lbs	160	160	160

Your operating costs will depend on your utility rates and use. The estimated operating cost is based on a electricity cost of \$.115 per kWh. For more information, visit www.ftc.gov/energy.

Due to continuing research in new energy-saving technology, specifications are subject to change without notice.



Single Zone

CEILING CASSETTE HEAT PUMPS

24000 and 36000 Btu. Ceiling cassette models install nearly flush with a drop ceiling for a clean and efficient installation.

Features

- Inverter technology (variable speed compressor)
- Internal condensate pump included with 31-1/2" lift
- Natural air flow
- 4-Way cooling
- Surge Cool/Heat
- Cooling mode
- Dehumidifying mode
- Night Quiet Operation
- Built-in low ambient standard, down to 14°F (Cooling mode)
- Fan mode
- Independent vane control
- 5 Fan speeds
- Evaporator frost control
- 24-hour on-off timer
- Auto restart
- Auto changeover
- Temperature display on remote
- Ultra-quiet turbo fan
- DiamonGold Advanced Corrosion Protection™
- Clean, modern look
- Flexible installation
- ENERGY STAR® qualified models
- Precise air distribution

Low profile indoor unit is recessed into the ceiling for a clean look and greater clearance.



MC24Y3J



MRC24Y3J



MC36Y3J



MRC36Y3J

SPECIFICATIONS

PERFORMANCE RATINGS	Single Zone Cassette H/P		
	24k	36k	
SYSTEM MODEL NO.	C24YJ	C36YJ	
INDOOR MODEL	MC24Y3J	MC36Y3J	
OUTDOOR MODEL	MRC24Y3J	MRC36Y3J	
SPECIFICATIONS			
CAPACITY COOLING (RATED)	Btu	24,000	36,000
CAPACITY COOLING (MIN-MAX)	Btu	9,700-26,700	14,000-42,000
CAPACITY HEATING @17°F (RATED)	Btu	27,000	40,000
CAPACITY HEATING (MIN-MAX)	Btu	10,900-30,000	14,500-45,000
COOLING AMPS		15.1	20.2
HEATING AMPS		15.1	20.8
SENSIBLE HEAT RATIO		.77	.76
SEER		17.0	19.0
EER		12.5	13.5
HSPF		9.7	9.5
ENERGY STAR *		Yes	Yes
MOISTURE REMOVAL	Pts/h	5.1	7.7
AIRFLOW (LOW, MED, HIGH)	CFM	459 / 530 / 600	918 / 989 / 1,060
SOUND RATING - INDOOR	dB(A)	57	65
SOUND RATING - OUTDOOR	dB(A)	62	67
OPERATING RANGE (COOLING)	°F	5-118	5-118
OPERATING RANGE (HEATING)	°F	-4-64	-4-64
EST. YEARLY OPERATING COST	\$	172	240
ELECTRICAL DATA			
POWER SOURCE	V	208/230/60/1	208/230/60/1
MINIMUM AMPACITY	A	18.1	24.5
COOLING WATTS	W	1910	Pen2970ding
MAX. TD FUSE/BREAKER	A	30	40
POWER AND COMMUNICATION CABLE	No. x AWG	4 x 18	4 x 18
REFRIGERATION SYSTEM			
REFRIGERANT		R410A	R410A
COMPRESSOR TYPE		Twin Rotary	Twin Rotary
CONNECTIONS		Flare	Flare
LIQUID LINE O.D.	in	3/8	3/8
SUCTION LINE O.D.	in	5/8	5/8
FACTORY PRECHARGE	ft	25	25
REFRIGERANT CHARGE	oz	71	120
MIN./MAX. LINE LENGTH	ft	25-164	25-246
MAX. HEIGHT DIFFERENCE	ft	98	98
DIMENSIONS & WEIGHT			
INDOOR UNIT			
W X H X D	in	33-1/16 x 8-1/16 x 33-1/16	33-1/16 x 11-3/8 x 33-1/16
NET WEIGHT	lbs	45	54
SHIPPING WEIGHT	lbs	58	65
INDOOR UNIT GRILLE** W X H X D	in	37-3/8 x 15/16 x 37-3/8	37-3/8 x 15/16 x 37-3/8
INDOOR UNIT GRILLE** NET WEIGHT	lbs	11	20
OUTDOOR UNIT			
W X H X D	in	37-7/16 x 32-7/8 x 13	37-13/32 x 54-3/8 x 13
NET WEIGHT	lbs	132	203
SHIPPING WEIGHT	lbs	146	227
TOTAL NET WEIGHT	lbs	178	257
TOTAL SHIPPING WEIGHT	lbs	203	293

Your operating costs will depend on your utility rates and use. The estimated operating cost is based on a electricity cost of \$.115 per kWh. For more information, visit www.ftc.gov/energy.

*System meets ENERGY STAR® published minimums.

**Models require grille. Grille sold separately.

Due to continuing research in new energy-saving technology, specifications are subject to change without notice.



Single Zone

CONCEALED DUCT HEAT PUMPS

24000 and 36000 Btu. Indoor unit is installed in the ceiling or furr down for unobtrusive installation.

Features

- Inverter technology (variable speed compressor)
- Internal condensate pump included with 31-1/2" lift
- Cooling mode
- Dehumidifying mode
- 3 Fan speeds+
- 24-hour on-off timer
- Auto restart
- Auto changeover
- Sleep mode
- Control lock function
- External Static Pressure Range(ESP)
 - 24,000 (0.1 - 0.78) WC
 - 36,000 (0.15 - 0.6) WC



MD24Y3J, MD36Y3J



MRD24Y3J



MRD36Y3J

SPECIFICATIONS

PERFORMANCE RATINGS	Single Zone Concealed Ducted H/P		
	24k	36k	
SYSTEM MODEL NO.	D24YJ	D36YJ	
INDOOR MODEL	MD24Y3J	MD36Y3J	
OUTDOOR MODEL	MR24UY3J	MR36U3J	
SPECIFICATIONS			
CAPACITY COOLING (RATED)	Btu	24,000	36,000
CAPACITY COOLING (MIN-MAX)	Btu	9,700~26,700	16,000~41,400
CAPACITY HEATING @17°F (RATED)	Btu	27,000	40,000
CAPACITY HEATING (MIN-MAX)	Btu	10,900~30,000	17,500~48,000
COOLING AMPS		15.1	20.8
HEATING AMPS		15.1	21.4
SENSIBLE HEAT RATIO		.68	.67
SEER		17.0	17.6
EER		12.0	12.1
HSPF		10.0	9.2
ENERGY STAR		No	No
MOISTURE REMOVAL	Pts/h	7.0	10.6
AIRFLOW (LOW, MED, HIGH)	CFM	530 / 618 / 688	706 / 953 / 1,130
SOUND RATING - INDOOR	dB(A)	56	56
SOUND RATING - OUTDOOR	dB(A)	62	67
OPERATING RANGE (COOLING)	°F	5~118	5~118
OPERATING RANGE (HEATING)	°F	-4~64	-4~64
EST. YEARLY OPERATING COST	\$	180	268
ELECTRICAL DATA			
POWER SOURCE		208/230/60/1	208/230/60/1
MINIMUM AMPACITY	A	18.1	24.5
COOLING WATTS	W	2000	2910
MAX. TD FUSE/BREAKER	A	30	40
POWER AND COMMUNICATION CABLE	No. x AWG	4 x 18	4 x 18
REFRIGERATION SYSTEM			
REFRIGERANT		R410A	R410A
COMPRESSOR TYPE		Twin Rotary	Twin Rotary
CONNECTIONS		Flare	Flare
LIQUID LINE O.D.	in	3/8	3/8
SUCTION LINE O.D.	in	5/8	5/8
FACTORY PRECHARGE	ft	25	25
REFRIGERANT CHARGE	oz	71	120
MIN./MAX. LINE LENGTH	ft	25~164	25~246
MAX. HEIGHT DIFFERENCE	ft	98	98
DIMENSIONS & WEIGHT			
INDOOR UNIT			
W X H X D	in	46-9/16 x 11-3/4 x 17-3/4	48-1/2 x 15 x 23-1/4
NET WEIGHT	lbs	73	125
SHIPPING WEIGHT	lbs	95	139
OUTDOOR UNIT			
W X H X D	in	37-7/16 x 32-7/8 x 13	37-7/16 x 54-3/8 x 13
NET WEIGHT	lbs	132	203
SHIPPING WEIGHT	lbs	146	227
TOTAL NET WEIGHT	lbs	205	327
TOTAL SHIPPING WEIGHT	lbs	240	366

Your operating costs will depend on your utility rates and use. The estimated operating cost is based on a electricity cost of \$.115 per kWh. For more information, visit www.ftc.gov/energy.

Due to continuing research in new energy-saving technology, specifications are subject to change without notice.



Multizone

WALL-MOUNTED HEAT PUMPS

High efficiency heat pumps with features for comfort and convenience year 'round. In heating mode, units efficiently heat by using approximately 1/4 of the energy required by electric heat.

Features

- Inverter technology (variable speed compressor)
- High efficiency for low operating cost
- DiamonGold Advanced Corrosion Protection™
- Self-cleaning indoor coil
- Cooling/Heating/Fan mode
- Surge Cool/Heat
- Natural air flow
- 4-Way auto swing
- Ultra quiet operation
- Sleep mode
- Dehumidifying mode
- Auto restart
- Auto changeover
- Built-in low ambient standard, down to 14°F (Cooling Mode)
- 24-hour on-off timer
- Condensate sensor connection
- Built-in kick stand



MW09Y3J, MW12Y3J



MW18Y3J



MR24DY3JM



MR36TQY3JM

SPECIFICATIONS

PERFORMANCE RATINGS	Multi Zone Wall Mounted			
	9k	12k	18k	
INDOOR MODEL	MW09Y3J	MW12Y3J	MW18Y3J	
SPECIFICATIONS				
CAPACITY COOLING (RATED)	Btu	9,000	11,200	17,000
CAPACITY HEATING (RATED)	Btu	10,800	13,300	20,200
MOISTURE REMOVAL	Pts/h	2.6	3.0	5.3
AIRFLOW (QUIET, LOW, MED, HIGH)	CFM	124/212/272/335	124/212/272/335	300/399/509/622
SOUND RATING - INDOOR	dB-A	19 / 24 / 33 / 38	19 / 24 / 33 / 39	29 / 35 / 40 / 45
ELECTRICAL DATA				
POWER SOURCE	V, Ø, Hz	230/208-60-1	230/208-60-1	230/208-60-1
REFRIGERATION SYSTEM				
CONNECTIONS		Flare	Flare	Flare
LIQUID LINE O.D.	in	1/4	1/4	1/4
SUCTION LINE O.D.	in	3/8	3/8	1/2
DIMENSIONS & WEIGHT				
W X H X D	in	35-1/4 x 11-1/4 x 8-1/4	35-1/4 x 11-1/4 x 8-1/4	40-5/8 x 12-7/8 x 9-5/8
NET WEIGHT	lbs	23	23	31
SHIPPING WEIGHT	lbs	27	27	35

PERFORMANCE RATINGS	Multi Outdoor		
	24k	36k	
OUTDOOR MODEL	MR24DY3JM	MR36TQY3JM	
SPECIFICATIONS			
POWER SOURCE	208/230/60/1		
EST. YEARLY OPERATING COST	\$	122-125	170-245
RUNNING CURRENT COOLING MIN.-RATED-MAX.	A	2.8-6.6-14.0	3.3-11.8-17.0
RUNNING CURRENT HEATING MIN.-RATED-MAX.	A	3.0-10.2-14.1	4.9-15.5-17.8
POWER INPUT COOLING MIN.-RATED-MAX.	W	390-1430-3090	770-2720-3920
POWER INPUT HEATING MIN.-RATED-MAX.	W	420-2210-3100	1120-3580-4100
POWER AND COMMUNICATION CABLE	No. x AWG	4 X 18	4 X 18
DIMENSIONS W X H X D	inch	34-1/4 x 31-7/8 x 12-5/8	35-7/16 x 45-7/8 x 14-5/8
NET WEIGHT	lbs	130	209
SHIPPING WEIGHT	lbs	139	223
REFRIGERATION SYSTEM			
REFRIGERANT	R410A		
FACTORY PRECHARGE	ft	74	98
REFRIGERANT CHARGE	oz	74	124
LIQUID LINE O.D.	in	1/4	1/4
SUCTION LINE O.D.	in	3/8	3/8
MIN./MAX. LINE LENGTH (EACH)	ft	10-82	10-82
MIN./MAX. LINE LENGTH (TOTAL)	ft	75-246	75-246
MAX. HEIGHT DIFFERENCE	ft	49	49
SOUND PRESSURE LEVEL COOLING	A	51	57
SOUND PRESSURE LEVEL HEATING	A	51	57
OPERATING RANGE COOLING MIN. ~ MAX.	°F DB	14 ~ 114	14 ~ 114
OPERATING RANGE HEATING MIN. ~ MAX.	°F WB	5 ~ 64	5 ~ 64
MINIMUM AMPACITY	A	15	17
MAX. TD FUSE/BREAKER	A	25	25

Your operating costs will depend on your utility rates and use. The estimated operating cost is based on a electricity cost of \$.115 per kWh. For more information, visit www.ftc.gov/energy.

Due to continuing research in new energy-saving technology, specifications are subject to change without notice.



Multizone

CEILING CASSETTE HEAT PUMPS

Ceiling cassette models install nearly flush with a drop ceiling for a clean and efficient installation.

Features

- Inverter technology (variable speed compressor)
- Internal condensate pump included with 31-1/2" lift
- Natural air flow
- 4-Way cooling
- Surge Cool/Heat
- Cooling mode
- Dehumidifying mode
- Night Quiet Operation
- Built-in low ambient standard, down to 14°F (Cooling mode)
- Fan mode
- Independent vane control
- 5 Fan speeds
- Evaporator frost control
- 24-hour on-off timer
- Auto restart
- Auto changeover
- Temperature display on remote
- Ultra-quiet turbo fan
- DiamonGold Advanced Corrosion Protection™
- Clean, modern look
- Flexible installation
- ENERGY STAR® qualified models
- Precise air distribution



MC12Y3JM, MC18Y3JM



MR24DY3JM



MR36TQY3JM



SPECIFICATIONS

PERFORMANCE RATINGS	Multi Zone Cassette		
	MC12Y3JM	MC18Y3JM	
INDOOR MODEL	MC12Y3JM	MC18Y3JM	
SPECIFICATIONS			
CAPACITY COOLING (RATED)	Btu	12,000	18,000
MOISTURE REMOVAL	Pts/h	4.2	4.2
AIRFLOW (LOW, MED, HIGH)	CFM	247 / 283 /335	388 / 424 / 459
SOUND RATING - INDOOR	dB-A	32/35/38	34/37/38
ELECTRICAL DATA			
POWER SOURCE	V, Ø, Hz	208/230, 1, 60	208/230, 1, 60
POWER AND COMMUNICATION CABLE	No. x AWG	4C x 18	4C x 18
REFRIGERATION SYSTEM			
CONNECTIONS			
LIQUID LINE O.D.	in	1/4	1/4
SUCTION LINE O.D.	in	3/8	1/2
DIMENSIONS & WEIGHT			
W X H X D	in	22-7/16 x 8-7/16 x 22-7/16	22-7/16 x 10-3/32 x 22-7/16
NET WEIGHT	lbs	31	33
SHIPPING WEIGHT	lbs	36	42
NDOOR UNIT GRILLE* W X H X D	in	27-9/16 x 7/8 x 27-9/16	27-9/16 x 7/8 x 27-9/16
INDOOR UNIT GRILLE* NET WEIGHT	lbs	6.6	6.6

PERFORMANCE RATINGS	Multi Outdoor		
	24k	36k	
OUTDOOR MODEL	MR24DY3JM	MR36TQY3JM	
SPECIFICATIONS			
POWER SOURCE	208/230/60/1	208/230/60/1	
EST. YEARLY OPERATING COST	\$	122-125	170-245
RUNNING CURRENT COOLING MIN.-RATED-MAX.	A	2.8~6.6~14.0	3.3~11.8~17.0
RUNNING CURRENT HEATING MIN.-RATED-MAX.	A	3.0~10.2~14.1	4.9~15.5~17.8
POWER INPUT COOLING MIN.-RATED-MAX.	W	390~1430~3090	770~2720~3920
POWER INPUT HEATING MIN.-RATED-MAX.	W	420~2210~3100	1120~3580~4100
POWER AND COMMUNICATION CABLE	No. x AWG	4 X 18	4 X 18
DIMENSIONS W X H X D	inch	34-1/4 x 31-7/8 x12-5/8	35-7/16 x 45-7/8 x14-5/8
NET WEIGHT	lbs	130	209
SHIPPING WEIGHT	lbs	139	223
REFRIGERATION SYSTEM			
REFRIGERANT		R410A	R410A
FACTORY PRECHARGE	ft	74	98
REFRIGERANT CHARGE	oz	74	124
LIQUID LINE O.D.	in	1/4	1/4
SUCTION LINE O.D.	in	3/8	3/8
MIN./MAX. LINE LENGTH (EACH)	ft	10~82	10~82
MIN./MAX. LINE LENGTH (TOTAL)	ft	75~246	75~246
MAX. HEIGHT DIFFERENCE	ft	49	49
SOUND PRESSURE LEVEL COOLING	A	51	57
SOUND PRESSURE LEVEL HEATING	A	51	57
OPERATING RANGE COOLING MIN. ~ MAX.	°F DB	14 ~ 114	14 ~ 114
OPERATINGRANGE HEATING MIN. ~ MAX.	°F WB	5 ~ 64	5 ~ 64
MINIMUM AMPACITY	A	15	17
MAX. TD FUSE/BREAKER	A	25	25

*Models require grille. Grille sold separately.

Your operating costs will depend on your utility rates and use. The estimated operating cost is based on a electricity cost of \$.115 per kWh. For more information, visit www.ftc.gov/energy.

Due to continuing research in new energy-saving technology, specifications are subject to change without notice.



Multizone

CONCEALED DUCT HEAT PUMPS

Indoor unit is installed in the ceiling or furr down for unobtrusive installation.

Features

- Inverter technology (variable speed compressor)
- Internal condensate pump included with 31-1/2" lift
- Cooling mode
- Dehumidifying mode
- 3 Fan speeds+
- 24-hour on-off timer
- Auto restart
- Auto changeover
- Sleep mode
- Control lock function
- External Static Pressure Range(ESP)
 - 12,000 (0.0 - 0.16) WC
 - 18,000 (0.0 - 0.16) WC

Fresh air can be easily introduced to the conditioned space whenever required.



MD12Y3JM, MD18Y3JM



MR24DY3JM



MR36TQY3JM

SPECIFICATIONS

PERFORMANCE RATINGS	Multi Zone Concealed Ducted		
	MD12Y3JM	MD18Y3JM	
INDOOR MODEL	MD12Y3JM	MD18Y3JM	
SPECIFICATIONS			
CAPACITY COOLING (RATED)	Btu	12,000	18,000
MOISTURE REMOVAL	Pts/h	2.5	4.2
AIRFLOW (LOW, MED, HIGH)	CFM	265 / 300 / 335	406 / 477 / 530
SOUND RATING - INDOOR	dB-A	26/31/33	29/31/34
ELECTRICAL DATA			
POWER SOURCE		208/230, 1, 60	208/230, 1, 60
POWER AND COMMUNICATION CABLE	No. x AWG	4C x 18	4C x 18
REFRIGERATION SYSTEM			
CONNECTIONS		Flare	Flare
LIQUID LINE O.D.	in	1/4	1/4
SUCTION LINE O.D.	in	3/8	1/2
DIMENSIONS & WEIGHT			
W X H X D	in	32-9/32 x 7-15/32 x 22-5/8	43-5/16 x 7-15/32 x 22-5/8
NET WEIGHT	lbs	45	58
SHIPPING WEIGHT	lbs	51	65

PERFORMANCE RATINGS	Multi Outdoor		
	24k	36k	
OUTDOOR MODEL	MR24DY3JM	MR36TQY3JM	
SPECIFICATIONS			
POWER SOURCE		208/230/60/1	208/230/60/1
EST. YEARLY OPERATING COST	\$	122-125	170-245
RUNNING CURRENT COOLING MIN.-RATED-MAX.	A	2.8~6.6~14.0	3.3~11.8~17.0
RUNNING CURRENT HEATING MIN.-RATED-MAX.	A	3.0~10.2~14.1	4.9~15.5~17.8
POWER INPUT COOLING MIN.-RATED-MAX.	W	390~1430~3090	770~2720~3920
POWER INPUT HEATING MIN.-RATED-MAX.	W	420~2210~3100	1120~3580~4100
POWER AND COMMUNICATION CABLE	No. x AWG	4 X 18	4 X 18
DIMENSIONS W X H X D	inch	34-1/4 x 31-7/8 x 12-5/8	35-7/16 x 45-7/8 x 14-5/8
NET WEIGHT	lbs	130	209
SHIPPING WEIGHT	lbs	139	223
REFRIGERATION SYSTEM			
REFRIGERANT		R410A	R410A
FACTORY PRECHARGE	ft	74	98
REFRIGERANT CHARGE	oz	74	124
LIQUID LINE O.D.	in	1/4	1/4
SUCTION LINE O.D.	in	3/8	3/8
MAX. LINE LENGTH	ft	246	246
MAX. HEIGHT DIFFERENCE	ft	49	49
SOUND PRESSURE LEVEL COOLING	A	51	57
SOUND PRESSURE LEVEL HEATING	A	51	57
OPERATING RANGE COOLING MIN. ~ MAX.	°F DB	14 ~ 114	14 ~ 114
OPERATINGRANGE HEATING MIN. ~ MAX.	°F WB	5 ~ 64	5 ~ 64
MINIMUM AMPACITY	A	15.4	16.8
MAX. TD FUSE/BREAKER	A	25	25

Your operating costs will depend on your utility rates and use. The estimated operating cost is based on a electricity cost of \$.115 per kWh. For more information, visit www.ftc.gov/energy.

Due to continuing research in new energy-saving technology, specifications are subject to change without notice.



Remote Controls

Wired and wireless controllers.

Wireless Controller



Cassette & All Wall-mounted Models

Wired Controllers

Wall control thermostat with infrared sensor that enables communication between the remote control and the thermostat.



Concealed Ducted
D24YJ, D36YJ
MD12Y3JM, MD18Y3JM



DWC1- Optional
All Ductless Models

PROGRAMMABLE SETTINGS

- Simple program (1 to 7 hour) ON/OFF
- Sleep program ON/OFF at set time
- ON at set time
- OFF at set time
- 7 Day schedule
- Vacation at user set time ON/OFF

Multizone

Mix and match wall-mounted, concealed duct and ceiling cassette models.



131

MULTIZONE
COMBINATIONS

Enjoy the flexibility to mix and match systems to fit your application.

DIAMONGOLD
Advanced Corrosion Protection™



5YR.
PARTS
WARRANTY

7YR.
COMPRESSOR
WARRANTY

PRECISION
INVERTER™

SPECIFICATIONS

24K		Combination of Indoor Units (kBtu/h Class)														
Indoor Units	Wall Mounted			Ducted		Cassette		Capacity			Efficiency					
	9K	12K	18K	12K	18K	12K	18K	Min	Nominal	Max	SEER	EER	HSPF	COP	E-STAR*	
2	◆◆							10798	17000	19800	19	12.6	7.7	3.0	—	
	◆	◆						11100	17000	23100	19	12.8	7.7	3.1	—	
	◆		◆					11400	19200	27500	19	13.1	8.2	3.3	YES	
	◆			◆				10798	18600	23100	16.7	12.1	7.8	3.1	—	
	◆				◆			10798	18600	27500	16.7	12.3	8.2	3.3	YES	
	◆					◆		10798	18600	23100	19.0	12.8	7.7	3.1	—	
	◆						◆	10798	18600	27500	19.0	13.1	8.2	3.3	YES	
		◆◆							11400	19200	25500	19	13.1	8.2	3.3	YES
		◆	◆						11400	19200	27500	19	13.1	8.2	3.3	YES
		◆		◆					11400	18600	25500	16.7	12.3	8.2	3.3	YES
		◆			◆				11400	18600	27500	16.7	12.3	8.2	3.3	YES
		◆				◆			11400	18600	25500	19	13.1	8.2	3.3	YES
		◆					◆		11400	18600	27500	19	13.1	8.2	3.3	YES
			◆	◆					11400	18600	25500	16.7	12.3	8.2	3.3	YES
		◆			◆			11400	18600	27500	19	13.1	8.2	3.3	YES	
			◆◆					12300	18600	25500	14.4	11.5	8.1	3.3	—	
						◆◆		12300	18600	25500	19	13.1	8.2	3.3	YES	
3	◆◆◆							11700	19200	28800	21.7	13.4	9.4	3.5	YES	
	◆◆	◆						11700	19200	28800	21.7	13.4	9.4	3.5	YES	
	◆◆			◆				11700	18600	28800	19.5	12.6	9.0	3.5	YES	
	◆◆					◆		11700	18600	28800	21.7	13.4	9.4	3.5	YES	
	◆	◆◆						11700	19200	28800	21.7	13.4	9.4	3.5	YES	
	◆			◆◆				11700	18600	28800	19.05	12.6	9.0	3.5	YES	
	◆					◆◆		11700	18600	28800	21.7	13.4	9.4	3.5	YES	
	◆	◆		◆				11700	18600	28800	19.05	12.6	9.0	3.5	YES	
	◆	◆				◆		11700	18600	28800	21.7	13.4	9.4	3.5	YES	
36K		Combination of Indoor Units (kBtu/h Class)														
Indoor Units	Wall Mounted			Ducted		Cassette		Capacity			Efficiency					
	9K	12K	18K	12K	18K	12K	18K	Min	Nominal	Max	SEER	EER	HSPF	COP	E-STAR*	
2	◆◆							10798	18000	19800	13.5	9.5	9.3	2.9	—	
	◆	◆						12597	21000	23100	14.1	10.0	8.9	2.8	—	
	◆		◆					16197	27000	29700	15.8	11.2	10.0	3.1	—	
	◆			◆				10798	34000	36300	13.8	9.7	8.9	2.8	—	
	◆				◆			10798	34000	36300	15.4	10.9	9.5	3.1	—	
	◆					◆		10798	34000	36300	14.1	10.0	8.9	2.8	—	
	◆						◆	10798	34000	36300	15.8	11.2	10.0	3.1	—	
		◆◆							14397	24000	26400	14.7	10.3	10.0	3.1	—
		◆	◆						17996	30000	33000	16.4	11.5	10.0	3.1	—
		◆		◆					17996	34000	36300	14.3	10.1	9.5	3.1	—
		◆			◆				17996	34000	36300	16	11.3	9.5	3.1	—
		◆				◆			17996	34000	36300	14.7	10.3	10	3.1	—
		◆					◆		17996	34000	36300	16.4	11.5	10	3.1	—
		◆						◆	17996	34000	36300	17.1	11.5	10.1	3.2	—
			◆◆						19796	33000	36300	17.1	11.5	10.1	3.2	—
			◆	◆					19796	34000	36300	16	11.3	9.5	3.1	—
			◆		◆				19796	34000	36300	15.8	11.2	9.6	3.1	—
			◆			◆			19796	34000	36300	17.1	11.5	10.1	3.2	—
			◆				◆		19796	34000	36300	16	11.3	9.5	3.1	—
			◆					◆	19796	34000	36300	15.8	11.2	9.6	3.1	—

*Systems meet ENERGY STAR® published minimums.

SPECIFICATIONS

36K		Combination of Indoor Units (kBtu/h Class)														
Indoor Units	Wall Mounted			Ducted		Cassette		Capacity			Efficiency					
	9K	12K	18K	12K	18K	12K	18K	Min	Nominal	Max	SEER	EER	HSPF	COP	E-STAR*	
3			◆					19796	34000	36300	16.4	11.5	10.0	3.1	—	
			◆				◆	19796	34000	36300	17.1	11.5	10.1	3.2	—	
				◆◆				14397	24000	26400	13.9	9.9	9.0	3.0	—	
				◆	◆			17996	30000	33000	15.5	11.1	9.0	3.0	—	
				◆		◆		14397	24000	26400	14.3	10.1	9.5	3.1	—	
				◆			◆	17996	30000	33000	16.0	11.3	9.5	3.1	—	
					◆◆			19796	33000	36300	15.4	11.0	9.0	3.0	—	
					◆	◆			19796	33000	36300	16.0	11.3	9.5	3.1	—
					◆		◆		19796	33000	36300	15.8	11.2	9.6	3.1	—
							◆◆		14397	24000	26400	14.7	10.3	10.0	3.1	—
							◆	◆	17996	17996	17996	16.4	11.5	10.0	3.1	—
								◆◆	19796	33000	36300	17.1	11.5	10.1	3.2	—
	◆◆◆								16197	27000	29700	15.8	11.2	10.0	3.1	—
	◆◆	◆							17996	30000	33000	16.4	11.5	10.0	3.1	—
	◆◆		◆						20396	34000	37400	17.5	12.5	10.5	3.4	YES
	◆◆			◆					10798	34000	37400	16	11.3	9.5	3.1	—
	◆◆				◆				10798	34000	37400	17	12.3	10.0	3.3	YES
	◆◆						◆		10798	34000	37400	16.4	11.5	10.0	3.1	—
	◆◆							◆	10798	34000	37400	17.5	12.5	10.5	3.4	YES
	◆	◆◆							20396	34000	37400	17.1	12.0	10.4	3.3	YES
	◆	◆	◆						20396	34000	37400	17.5	12.5	10.4	3.4	YES
	◆	◆		◆					10798	34000	37400	16.7	11.8	9.8	3.2	—
	◆	◆			◆				10798	34000	37400	17.0	12.3	10.0	3.3	YES
	◆	◆					◆		10798	34000	37400	17.1	12.0	10.4	3.3	YES
	◆	◆						◆	10798	34000	37400	17.5	12.5	10.5	3.4	YES
	◆	◆							10798	34000	37400	17.5	12.5	10.5	3.4	YES
	◆		◆◆						20396	34000	37400	17.5	12.5	10.5	3.4	YES
	◆		◆	◆					10798	34000	37400	17.0	12.3	10.0	3.3	YES
	◆		◆			◆			10798	34000	37400	17	12.3	10.0	3.3	YES
	◆		◆				◆		10798	34000	37400	17.5	12.5	10.5	3.4	YES
	◆		◆					◆	10798	34000	37400	17.5	12.5	10.5	3.4	YES
		◆◆◆							20396	34000	37400	17.5	12.5	10.5	3.4	YES
		◆◆	◆						20396	34000	37400	17.5	12.5	10.5	3.4	YES
		◆◆		◆					20396	34000	37400	17	12.3	10	3.3	YES
	◆◆			◆				20396	34000	37400	17	12.3	10	3.3	YES	
	◆◆				◆			20396	34000	37400	17	12.3	10	3.3	YES	
	◆◆					◆		20396	34000	37400	17.5	12.5	10.5	3.4	YES	
	◆◆						◆	20396	34000	37400	17.5	12.5	10.5	3.4	YES	
	◆	◆◆						20396	34000	37400	17.5	12.5	10.5	3.4	YES	
	◆	◆	◆					20396	34000	37400	17.0	12.3	10.0	3.3	YES	
	◆	◆			◆			20396	34000	37400	17.0	12.3	10.0	3.3	YES	

*Systems meet ENERGY STAR® published minimums.

SPECIFICATIONS

36K		Combination of Indoor Units (kBTU/h Class)														
Indoor Units	Wall Mounted			Ducted		Cassette		Capacity			Efficiency					
	9K	12K	18K	12K	18K	12K	18K	Min	Nominal	Max	SEER	EER	HSPF	COP	E-STAR*	
3		◆	◆			◆		20396	34000	37400	17.5	12.5	10.5	3.4	YES	
		◆	◆				◆	20396	34000	37400	17.5	12.5	10.5	3.4	YES	
		◆		◆	◆			20396	34000	37400	17	12.3	10	3.3	YES	
		◆		◆		◆		20396	34000	37400	17	12.3	10	3.3	YES	
		◆				◆	◆	20396	34000	37400	17.5	12.5	10.5	3.4	YES	
			◆◆	◆				20396	34000	37400	17	12.3	10	3.3	YES	
			◆◆			◆		20396	34000	37400	17.5	12.5	10.5	3.4	YES	
			◆	◆		◆		20396	34000	37400	17	12.3	10	3.3	YES	
			◆		◆	◆		20396	34000	37400	17	12.3	10	3.3	YES	
				◆◆◆				20396	34000	37400	16.5	12	9.5	3.2	YES	
				◆◆	◆			20396	34000	37400	16.5	12	9.5	3.2	YES	
				◆◆		◆		20396	34000	37400	17	12.3	10	3.3	YES	
				◆◆			◆	20396	34000	37400	17	12.3	10	3.3	YES	
				◆	◆◆			20396	34000	37400	16.5	12	9.5	3.2	YES	
				◆			◆◆	20396	34000	37400	17	12.3	10	3.3	YES	
					◆◆	◆		20396	34000	37400	17	12.3	10	3.3	YES	
					◆	◆◆		20396	34000	37400	17	12.3	10	3.3	YES	
						◆◆◆		20396	34000	37400	17.5	12.5	10.4	3.4	YES	
						◆◆	◆	20396	34000	37400	17.5	12.5	10.4	3.4	YES	
						◆	◆◆	20396	34000	37400	17.5	12.5	10.4	3.4	YES	
4	◆◆◆◆							20396	34000	37400	17.5	12.5	10.4	3.4	YES	
	◆◆◆◆	◆						20396	34000	37400	17.5	12.5	10.4	3.4	YES	
	◆◆◆◆		◆					20396	34000	37400	17.5	12.5	10.4	3.4	YES	
	◆◆◆◆			◆				10798	34000	37400	17	12.3	10	3.3	YES	
	◆◆◆◆				◆			10798	34000	37400	17	12.3	10	3.3	YES	
	◆◆◆◆					◆		10798	34000	37400	17.5	12.5	10.4	3.4	YES	
	◆◆◆◆						◆	10798	34000	37400	17.5	12.5	10.4	3.4	YES	
	◆◆	◆◆						20396	34000	37400	17.5	12.5	10.4	3.4	YES	
	◆◆			◆◆				10798	34000	37400	17	12.3	10	3.3	YES	
	◆◆					◆◆		10798	34000	37400	17.5	12.5	10.4	3.4	YES	
	◆◆	◆		◆				10798	34000	37400	17	12.3	10	3.3	YES	
	◆◆	◆				◆		10798	34000	37400	17.5	12.5	10.4	3.4	YES	
	◆	◆◆◆						20396	34000	37400	17.5	12.5	10.4	3.4	YES	
	◆			◆◆◆				10798	34000	37400	17	12.3	10	3.3	YES	
	◆					◆◆◆		10798	34000	37400	17.5	12.5	10.4	3.4	YES	
		◆◆◆◆						20396	34000	37400	16.5	12.0	9.5	3.2	YES	
		◆◆		◆◆				20396	34000	37400	17	12.3	10	3.3	YES	
		◆◆				◆◆		20396	34000	37400	17.5	12.5	10.4	3.4	YES	
				◆◆◆◆				20396	34000	37400	17	12.3	10	3.3	YES	
				◆◆		◆◆		20396	34000	37400	17	12.3	10	3.3	YES	
					◆◆◆◆		20396	34000	37400	17.5	12.5	10.4	3.4	YES		

NOMENCLATURE

¹ M	² RH	³ 36	⁴ D	⁵ Y	⁶ 3	⁷ J	⁸ M
¹ Series	² Model Type	³ Capacity	⁴ Application	⁵ Refrigeration Cycle	⁶ Voltage	⁷ Marketing Model	⁸ Installation Type
Mini-split	W= Wall mounted C= Cassette D= Concealed Ducted R= Outdoor component WH= Wall mounted High SEER RH= Outdoor high SEER	9 = 9,000 BTU/h 12 = 12,000 BTU/h 18 = 18,000 BTU/h 24 = 24,000 BTU/h 30 = 30,000 BTU/h 36 = 36,000 BTU/h	Empty = Single D = Dual Zone T = Tri-Zone Q = Quad Zone U = Universal	C = Cool Only Y = Heat Pump	1 = 115V/60hz/1 3 = 230V/60hz/1	(Internal Use)	M = Multi Zone

Refrigeration Line Sets-Minimum/Maximum Lengths

Single Zone			
System Model	Outdoor	Indoor	Min./Max. in Feet
M09YJ	MR09Y3J	MW09Y3J	7 / 66
M12YJ	MR12Y3J	MW12Y3J	7 / 66
M18YJ	MR18Y3J	MW18Y3J	10 / 66
M09CJ	MR09C1J	MW09C1J	7 / 66
M12CJ	MR12C1J	MW12C1J	7 / 66
M18CJ	MR18C3J	MW18C3J	10 / 66
M24CJ	MR24C3J	MW24C3J	10 / 98
M24YJ	MR24Y3J	MW24Y3J	10 / 164
M30YJ	MR30Y3J	MW30Y3J	10 / 164
M36YJ	MR36Y3J	MW36Y3J	10 / 164
HM12YJ	MHR12Y3J	MHW12Y3J	10 / 49
C24YJ	MR24UY3J	MC24Y3J	25 / 164
C36YJ	MR36UY3J	MC36Y3J	25 / 246
D24YJ	MR24UY3J	MD24Y3J	25 / 164
D36YJ	MR36UY3J	MD36Y3J	25 / 246

Multizone Outdoor		
System Model	System Model	
MR24DY3JM	MR36TQY3JM	
75 / 246	75 / 246	Min./Max. Total
25 / 82	25 / 82	Min./Max. Each
10 Ft	10 Ft	Minimum Each

*Systems meet ENERGY STAR® published minimums.



FRIEDRICH

1 8 8 3