

33" French Door Bottom-Freezer

800 Series – Stainless Steel B22FT80SNS



B22FT80SNS
Stainless Steel

The standard-depth French Door refrigerator offers large storage capacity and keeps your produce fresh longer.

Features & Benefits

The LED lighting shines exceptionally bright and saves energy.

Clean exterior design for a perfect built-in look.

Spill-proof glass shelves prevent liquids from running off shelves.

Hidden hinges for clean design, sturdy support and easy opening.

The internal water dispenser delivers filtered and chilled water.

General Properties	
Reversible door hinge	N/A
Water filter	Yes
Lighting	LED
Defrost process refrigerator section	Frost-free
Number of shelves - refrigerator	5
Adjustable shelves - refrigerator	4 half-width
Shelf material - refrigerator	Tempered glass
Type of shelves - refrigerator	Spill-proof glass
Gallon storage bins	Yes
Humidity control drawer	2
Defrost process freezer section	Automatic
Number of drawers - freezer	2
Adjustable shelves - freezer	N/A
Shelf material - freezer	Metal
Type of shelves - freezer	Wire
Ice maker	Yes
Quick ice	No
Capacity	
Total unit gross capacity (cu. ft.) - AHAM	21.8 cu. ft.
Refrigerator gross capacity (cu. ft.)	16.27 cu. ft.
Freezer gross capacity (cu. ft.)	5.52 cu. ft.

Technical Details	
Current (A)	7.10 A
Volts (V)	110-120 V
Frequency (Hz)	60 Hz
Power cord length (in.)	62"
Plug type	120V-3 prong
Dimensions & Weight	
Appliance dimensions (H x W x D) (in.)	70 1/8" x 32 5/8" x 34 1/2"
Required cutout size (H x W x D) (in.)	70 5/8" x 33 7/8" x 32 7/8"
Net weight (lbs)	280 lbs
Efficiency	
ENERGY STAR® qualified	No
Energy consumption (kWh/yr)	640 kWh



For help and assistance with Bosch accessories please visit: www.bosch-eshop.com/eshop/bosch/us or call 1-800-944-2904 Mon-Fri 5am to 6pm PST Sat 6am to 3pm PST

Notes: All height, width and depth dimensions are shown in inches. Please refer to installation instructions prior to making cutout. BSH reserves the absolute and unrestricted right to change product materials and specifications, at any time, without notice. Consult the product's installation instructions for final dimensional data and other details. Applicable product warranty can be found in accompanying product literature or you may contact your account manager for further details.

Warranties: Bosch warrants that the Product is free from defects in materials and workmanship for a period of three hundred and sixty-five (365) days from the date of purchase. The foregoing timeline begins to run upon the date of purchase, and shall not be stalled, tolled, extended, or suspended, for any reason whatsoever. This Product is also warranted to be free from cosmetic defects in material and workmanship (such as scratches of stainless steel, paint/porcelain blemishes, chip, dents, or other damage to the finish of the Product, for a period of thirty (30) days from the date of purchase or closing date for new construction. This cosmetic warranty excludes slight color variations due to inherent differences in painted and porcelain parts, as well as differences caused by kitchen lighting, product location, or other similar factors. This cosmetic warranty specifically excludes any display, floor, "As Is", or "B" stock appliances.

For more information on our entire line of products, go to www.bosch-home.com/us or call 1-800-944-2904

© BSH Home Appliances Corporation. All rights reserved. Bosch is a registered trademark of Robert Bosch GmbH.

33" French Door Bottom-Freezer

800 Series – Stainless Steel B22FT80SNS



Installation Details

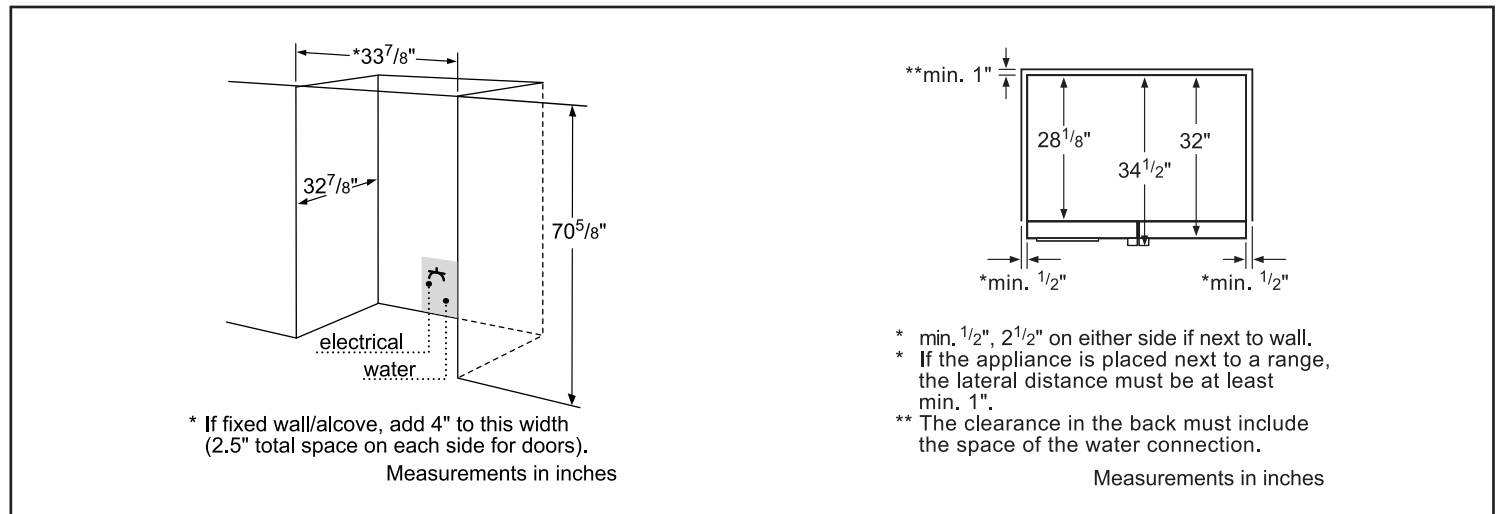
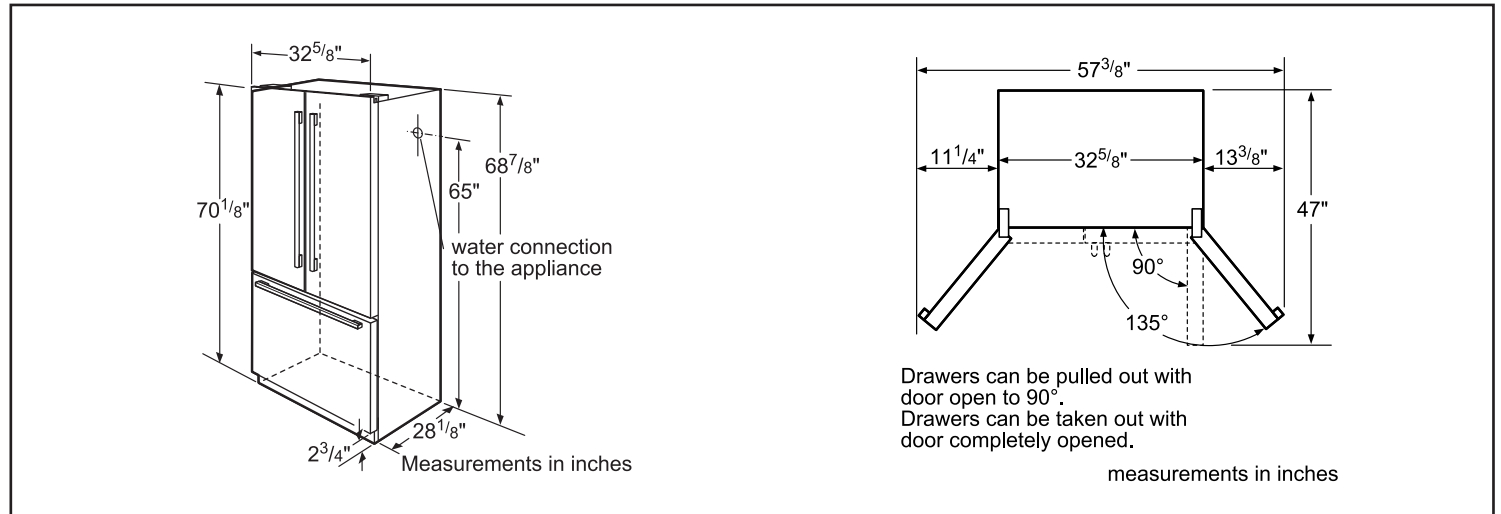

For help and assistance with Bosch accessories please visit: www.bosch-eshop.com/eshop/bosch/us or call 1-800-944-2904 Mon-Fri 5am to 6pm PST Sat 6am to 3pm PST

Notes: All height, width and depth dimensions are shown in inches. Please refer to installation instructions prior to making cutout. BSH reserves the absolute and unrestricted right to change product materials and specifications, at any time, without notice. Consult the product's installation instructions for final dimensional data and other details. Applicable product warranty can be found in accompanying product literature or you may contact your account manager for further details.

Warranties: Bosch warrants that the Product is free from defects in materials and workmanship for a period of three hundred and sixty-five (365) days from the date of purchase. The foregoing timeline begins to run upon the date of purchase, and shall not be stalled, tolled, extended, or suspended, for any reason whatsoever. This Product is also warranted to be free from cosmetic defects in material and workmanship (such as scratches of stainless steel, paint/porcelain blemishes, chip, dents, or other damage to the finish of the Product, for a period of thirty (30) days from the date of purchase or closing date for new construction. This cosmetic warranty excludes slight color variations due to inherent differences in painted and porcelain parts, as well as differences caused by kitchen lighting, product location, or other similar factors. This cosmetic warranty specifically excludes any display, floor, "As Is", or "B" stock appliances.

For more information on our entire line of products, go to www.bosch-home.com/us or call 1-800-944-2904

© BSH Home Appliances Corporation. All rights reserved. Bosch is a registered trademark of Robert Bosch GmbH.