

THE EXPERTS
IN ROOM AIR CONDITIONING



FRIEDRICH
1883

COMMERCIAL GRADE
AND
RESIDENTIAL GRADE
MODELS



THRU-THE-WALL AIR CONDITIONER GUIDE

WHEN SHOULD YOU INSTALL A SOLID SIDE SLEEVE?

A solid-side wall sleeve allows for installation in thick exterior walls where the installation of room air units with side vents would effect performance and may even void the warranty.

ROOM AIR CONDITIONER
Blocked side vents restrict air flow.

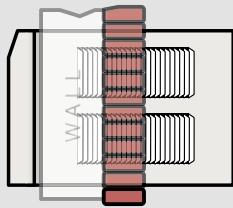

FRIEDRICH THRU-THE-WALL
Solid-side sleeve (no side vents) can be installed in thicker walls. Sleeve can be positioned flush with exterior wall.

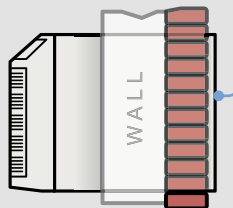

Or with minimum intrusion into the room.

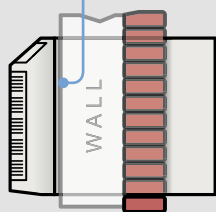

		THRU-THE-WALL MODELS	
		WallMaster®	Uni-Fit®
OVERVIEW	Sleeve size	Fits 27" sleeves	Fits sleeves from 24 1/2" to 27"
	Applications	RESIDENTIAL OR LIGHT COMMERCIAL	RESIDENTIAL OR LIGHT COMMERCIAL
COMFORT & CONVENIENCE	Perfect fit for Fedder's 27" sleeves	Y	—
	Top-mounted controls	Y	—
	Electronic controls	Y	Y
	Programmable timer	24 hr.	24 hr.
	Remote control	Y	Y
	Auto-restart when power is interrupted	Y	Y
	Smart Fan auto adjusting fan	Y	—
	Upward angled air discharge	Y	—
	Air flow direction control	4-way	6-way
	Fan speeds	3	3
SOUND REDUCTION TECHNOLOGY	Steel inner wall and extra dense insulation	Y	Steel inner wall
	Vibration-isolating design and components	Y	Y
	Superior airflow design	Y	—
EARTH FRIENDLY	ENERGY STAR® models	Y	Y
	Environmentally friendly R-410A	Y	Y
	Energy saver switch	Y	Y
HEALTH	Washable, antimicrobial air filter	Y	Y
	Stale air exhaust	—	Y
SAFETY	EntryGard™ anti-intrusion protection	Y	—
	Insect barrier	Y	—
INSTALLATION	Slideout chassis	Y	Y
	Power cord direction	Left	Right
	Concealed power cord option	Y	—
	Internal drain kit option	Y	—
	Baffle adapter kit (for installation in Fedders 'B' sleeves)	Y	—
	Condensate drain kit	Y	—

THRU-THE-WALL AIR CONDITIONERS



WALLMASTER®. A PERFECT FIT IN FRIEDRICH AND COMPETITOR'S 27" SLEEVES.

Commercial grade quality unit is ideal for installation in new construction, retrofits and remodels.

Perfect fit in 27" wall sleeves, including Fedders A and B* sleeves.



COOL



COOL & HEAT

WallMaster®
7800-15600 Btu
Up to 9.9 EER

WallMaster®
Electric Heat
COOLING
9500-15600 Btu
Up to 9.6 EER
ELECTRIC HEAT
9100-11000 Btu

WallMaster®
Heat Pump
COOLING
9300-12000 Btu
Up to 9.4 EER
HEATING
7300-9350 Btu

Select MODE, FAN SPEED, adjust TEMPERATURE and set the TIMER.

NOTE: Chassis requires WSD sleeve for new installations (sold and shipped separately)

WSD wall sleeve ships with weather panels and grille.

Sleeve is shown at right with standard galvanized steel inner panel, painted steel outer panel and standard grille



Inner steel weather panel.



WSD sleeve.



Outer weather panel



Standard grille

Fits Fedders A & B sleeves. *B sleeve installations require BAK accessory, baffle adapter kit.

Comfort & Convenience

- Easy-to-reach, top mount controls
- Remote control
- 24-hour timer
- Smart Fan auto-adjusts fan speed to maintain desired temperature
- 3-speed fan
- Auto restart
- Electronic defrost control
- Reversible louver allows a second airflow option

Energy Management and Compliance

- Money Saver® setting saves money by operating the fan only when needed
- ENERGY STAR® qualified models
- R-410A refrigerant

Health and IAQ

- Washable, antimicrobial filter

Durability & Quality

- Rotary compressors provide quiet, dependable performance
- Premium aluminum exterior grille
- Dense blower insulation
- Rifled copper tubing
- Impact resistant front cover
- High tech fins with sine wave lanced louvers increase energy efficiency by increasing surface area for heat exchange



Rifled copper tubing



Sine wave lanced louvers

Maintenance and Installation Features

- Mounts flush with the exterior wall for a neat appearance
- Ideal for thicker wall installations, where side fins don't fit
- Reversible louver allows for a second airflow option
- A high efficiency replacement for 27" sleeves including Fedders A and B*. Sleeve measures 27" W x 16 3/4" H

Accessories

- WSD sleeve, ships with inside and outside weather panel and standard grille
- AG architectural grille for use with WSD sleeve
- Baffle adapter kit for use with deep sleeve installations
- Drain kit for condensate disposal
- Internal drain kit for new construction applications where condensate drain system is built-in

Safety & Security

- EntryGuard™ anti-intrusion protection secures chassis to sleeve to deter 'kick-in' intrusion
- Power cord current leakage protected
- Insect barrier



Angled air discharge for superior air distribution when the unit is installed low on a wall. Reversible louver for a second air flow option.



Sleeve can be installed flush with the exterior wall. Optional AG architectural grille shown.

WallMaster® fits existing Fedders sleeves.

Sleeve Dimensions	Friedrich WSD Sleeve	Fedders A Sleeve	Fedders B Sleeve*
Height (inches)	16 3/4	16 3/4	16 3/4
Width (inches)	27	27	27
Depth (inches)	16 3/4	16 3/4	19 3/4

Chassis requires WSD sleeve (sold and shipped separately)

*Installation in Fedders B sleeve requires a baffle kit. See BAK accessory under accessories.



THRU-THE-WALL AIR CONDITIONERS

UNI-FIT® UNIVERSAL FIT FOR EASY REPLACEMENT IN EXISTING 24 1/2", 26" OR 27" SLEEVES.

Residential grade quality for installation in new construction, retrofits and remodels.



FITS SLEEVES
24 1/2", 26" AND 27" WIDE



Select MODE, FAN SPEED,
adjust TEMPERATURE and set
the TIMER.



COOL



COOL & HEAT

Uni-Fit®

8000-13000 Btu
Up to 9.6 EER

Uni-Fit® Electric Heat

COOLING
8000-11500 Btu
Up to 9.6 EER

ELECTRIC HEAT
3850-11200 Btu

USC wall sleeve ships with weather panels and grille.

Sleeve is shown at right with
standard painted steel inner
panel, painted steel outer
panel and standard grille



Inner weather panel



USC sleeve



Outer weather panel



Standard grille

NOTE: Chassis requires USC sleeve for new installations (sold and shipped separately)

UNI-FIT® FEATURES

Comfort & Convenience

- 6-way air flow control
- Remote control
- 24-hour timer
- 3-speed fan
- Auto restart
- Defrost control

Energy Management and Compliance

- Money Saver® setting saves money by conserving energy
- ENERGY STAR® qualified models
- R-410A refrigerant

Health and IAQ

- Washable antimicrobial filter
- Stale air exhaust

Durability & Quality

- Rotary compressors provide quiet, dependable performance
- Seacoast protection for corrosion resistance in harsh environments

Installation and Maintenance Features

- Universal fit trim ring
- Chassis designed to fit 24 1/2" to 27" sleeves
- USC sleeve fits standard 26" sleeve opening. See installation manual for exact dimensions.

Accessories

- USC sleeve ships with expanded aluminum grille
- Replacement grille ships with US/UE chassis for use in existing sleeves when a grille is needed

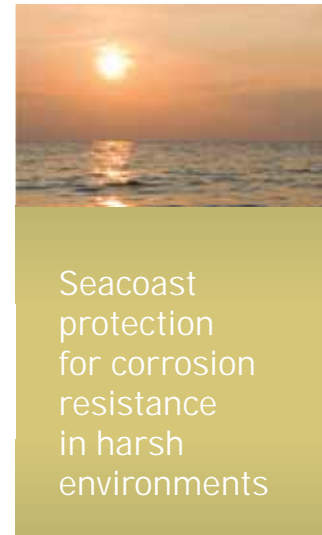

Seacoast protection for corrosion resistance in harsh environments

IMPORTANT: 1" gap on sides and 1/2" gap at top, which allows installation into varying sleeve sizes, can be covered by two-piece trim ring that fits over the chassis front. Trim ring comes standard with chassis.

Uni-Fit® installs in many existing sleeves.

Sleeve Dimensions	Friedrich USC Sleeve	Amana	Carrier (51S Series)	Fedders/Emerson/Friedrich WSD	Emerson/Fedders	GE/Hot-point	Whirlpool	White-Westinghouse/Frigidaire/Carrier (52F Series)
Height (inches)	15 1/2	15 5/8	16 7/8	16 3/4	15 3/4	15 5/8	16 1/2	15 1/4
Width (inches)	25 7/8	26	25 3/4	27	26 3/4	26	25 7/8	25 1/2
Depth (inches)	16 3/4	16 7/8	18 5/8	16 3/4 or 19 3/4	15	16 7/8	17 1/8 or 23	16, 17 1/2 or 22

NOTE: Chassis requires USC sleeve for new installations (sold and shipped separately)



THRU-THE-WALL OPTIONAL ACCESSORIES

WallMaster® 27" Sleeve Exterior Grilles



WSD SLEEVE
Standard Grille
Premium, stamped galvanized steel grille with powder coat paint. Ships with sleeve. Galvanized steel inner and outer weather panels also ship with sleeve.



WSD SLEEVE
Optional Architectural Grille- AG
Premium brushed aluminum grille.

IMPORTANT:

Operating the air conditioner with incorrect rear grille or without Baffle Adapter Kit (on 19 3/4" deep sleeve) will recirculate discharge air and cause compressor overload to trip.

This will cause the unit to shut down temporarily and may lead to premature compressor failure.

CORRECT Vertical Louvers

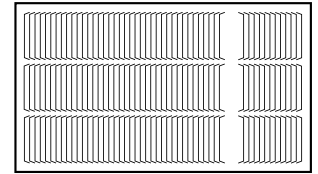

INCORRECT Horizontal Louvers

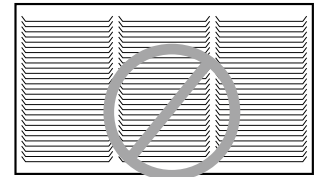

Installation Accessories (27" sleeve models only)

DK / Drain Kit

Installed at the back of the unit and allows for attachment to condensate disposal system, if necessary or desired.



IDK / Internal Drain Kit

New construction applications where a condensate drain system has been built into the wall interior.



BAK / Baffle Adapter Kit

Necessary when installing in a sleeve deeper than 16 3/4" deep, such as Fedders B sleeve (19 3/4" deep).



Uni-Fit® 26" Sleeve Exterior Grilles



USC Sleeve Standard Grille



Sleeve shown with Replacement Grille

STANDARD GRILLE – Ships with USC sleeve
Expanded aluminum grille designed for use with USC sleeve.

REPLACEMENT GRILLE – Ships with US/UE chassis
Black plastic for use on existing sleeves without any grille.

IMPORTANT:

When installing into an existing sleeve, consult Installation Section of your Installation/Operation Manual to determine whether or not the grille needs to be replaced and/or a baffle adapter should be used.

Sleeve/Chassis Dimensions

Model	Height	Width	Depth	Depth with Front	Minimum Extension Into Room	Minimum Extension Outside	Thru-the-wall Finished Hole		
							Height	Width	Max. Depth
WallMaster®									
WSD Sleeve	16 3/4"	27"	16 3/4"	23"	7 1/2"	9/16"	17 1/4"	27 1/4"	15 5/16"
Chassis	15 3/4"	26 1/2"	21"	22"	-	-	-	-	-
Uni-Fit®									
USC Sleeve	15 1/2"	25 7/8"	16 3/4"	20 1/2"	-	1/2"	15 3/4"	26 1/8"	16 1/4"
US Chassis	14 3/8"	24"	18 1/2"	20 1/8"	3 3/4"	-	-	-	-
UE Chassis	14 3/8"	24 5/8"	18"	19 5/8"	3 1/2"	-	-	-	-

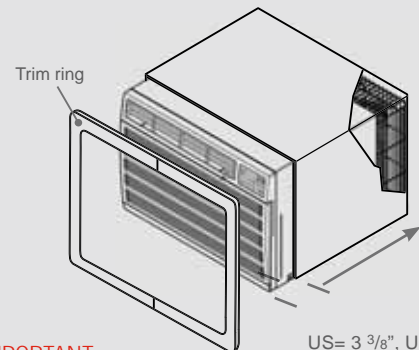

IMPORTANT:

US chassis w/front fully installed into USC sleeve extends into room 3 3/8". UE chassis w/front fully installed into USC sleeve extends into room 2 7/8". 1" gap on sides and 1/2" gap at top can be covered by two-piece trim ring that fits over the chassis front

SPECIFICATIONS

★ ENERGY STAR® models

Model	Cooling Btu	Heating Btu	Volts Rated	Cooling Amps	Cooling Watts	Heating Amps	Heating Watts	Energy Efficiency Ratio EER	Estimated Yearly Operating Cost	Moisture Removal Pints/HR	CFM	Sleeve	Net Weight Lbs.	Ship Weight Lbs.
WALLMASTER®														
<i>Cool only</i>														
★ WS08C10	7800	NA	115	7.1	788	NA	NA	9.9	†	1.2	250	WSD	93	97
★ WS10C10	9700	NA	115	10.0	1032	NA	NA	9.4	\$82	2.4	260	WSD	103	107
★ WS12C10C	11500	NA	115	11.5	1223	NA	NA	9.4	\$98	3.1	320	WSD	112	116
★ WS10C30	9500/9200	NA	230/208	4.5/4.7	989/958	NA	NA	9.6/9.6	\$79	1.5	300	WSD	101	105
★ WS12C30	11500/11200	NA	230/208	5.5/6.0	1223/1191	NA	NA	9.4/9.4	\$98	3.0	320	WSD	109	113
WS16C30	15600/15000	NA	230/208	8.3/8.9	1835/1765	NA	NA	8.5/8.5	\$144	4.2	290	WSD	119	123
<i>Heat Pump</i>														
★ WY09C33	9300/9000	7300/7300	230/208	4.4/4.7	989/957	3.8/4.0	839/793	9.4/9.4	\$79	2.1	250	WSD	103	107
WY12C33	12000/11800	9350/9200	230/208	6.1/6.4	1395/1372	4.8/5.1	1062/1010	8.6/8.6	\$111	2.6	275	WSD	111	115
<i>Cool with Electric Heat</i>														
WE10C33	9500/9200	11000/9100	230/208	4.5/4.7	989/957	16.0/14.7	3550/2950	9.6/9.6	\$79	1.5	300	WSD	121	125
WE12C33	11500/11200	11000/9100	230/208	5.5/6.0	1123/1191	16.0/14.7	3550/2950	9.4/9.4	\$98	3.0	320	WSD	107	111
WE16C33	15600/15000	11000/9100	230/208	8.3/8.9	1835/1765	16.0/14.7	3550/2950	8.5/8.5	\$140	4.2	290	WSD	116	120
UNI-FIT®														
<i>Cool Only</i>														
★ US08D10	8000	-	115	7.5	830	-	-	9.6	\$66	2.2	260	USC	73	79
★ US10D10	9800	-	115	9.6	1040	-	-	9.4	\$83	3.2	285	USC	78	84
★ US12D10	11500	-	115	11.2	1220	-	-	9.4	\$97	3.8	290	USC	80	87
★ US10D30A	10000/9800	-	230/208	4.7/5.2	1060/1040	-	-	9.4/9.4	\$85	3.2	285	USC	78	84
★ US12D30	11500/11200	-	230/208	5.6/6.0	1220/1190	-	-	9.4/9.4	\$97	3.8	290	USC	80	87
US14D30A	13000/12600	-	230/208	7.0/7.5	1520/1480	-	-	8.5/8.5	\$121	4.0	310	USC	94	97
<i>Cool with Electric Heat</i>														
UE08D11	8000	3850	115	7.5	830	10.7	1230	9.6	\$66	2.2	260	USC	73	79
UE10D33	10000/9800	11200/9200	230/208	4.7/5.2	1060/1040	15.3/14.0	3500/2900	9.4/9.4	\$85	3.2	285	USC	78	84
UE12D33	11500/11200	11200/9200	230/208	5.6/6.0	1220/1190	15.3/14.0	3500/2900	9.4/9.4	\$97	3.8	290	USC	80	87

WallMaster Heat Pump heating information (shown in red) indicates heat pump heating performance. WallMaster Electric Heat heating information (shown in red) indicates electric heat strip performance. For WallMaster Heat Pump electric heating performance refer to corresponding WallMaster Electric Heat model.

WALLMASTER HEAT PUMP

HEATING PERFORMANCE: Change-over from heat pump operation to resistance operation on models indicated is automatic at a preset outside ambient temperature of approximately 35°F.



Calculate the heat loss of the space to be heated. As long as the heat loss does not exceed the resistance heating capacity rating of the unit, the heating performance will be satisfactory.

Note: all models will produce condensate. If condensate disposal is desired, an optional drain kit is available.

DEFROST CONTROL: Initiated at 30°F (outdoor coil temperature) and terminated at 43°F (outdoor coil temperature). During defrost, the compressor stops and the electric heat starts, then operates with the fan to maintain indoor comfort. Below 43°F, the unit remains in electric heat mode.

DEFROST DRAIN: Drain automatically opens at approximately 50°F to prevent condensate from freezing inside drain pan.

Plug Face/ Circuit Rating

WallMaster® Model Number	Uni-Fit® Model Number	Circuit Rating Breaker or T-D Fuse	Plug Face (NEMA#)	Power Cord Length (ft.)	Wall Outlet Appearance
WS08C10, WS10C10, WS12C10C	US08D10, UE08D11 US10D10, US12D10	125V - 15A	5 - 15P	6	
WS10C30, WS12C30, WS16C30	US10D30A, US12D30, US14D30A	250V - 15A	6 - 15P	4	
WE10C33, WE12C33, WE16C33, WY09C33, WY12C33	UE10D33, UE12D33	250V - 20A	6 - 20P	4	

Power cords are located on front left of WallMaster models and on front right of Uni-Fit models.

Due to continuing research in new energy-saving technology, specifications are subject to change without notice. As an ENERGY STAR® partner, Friedrich Air Conditioning Co. has determined that the selected ENERGY STAR® models meet the ENERGY STAR® guidelines for energy efficiency.

Your operating costs will depend on your utility rates and use. The estimated operating cost is based on a electricity cost of \$.1065 per kWh. For more information, visit www.ftc.gov/energy.

† The estimated yearly operating cost of this model was not available at the time the range was published.

Model	Carton Dimensions INCHES		
	Height	Width	Depth
WallMaster®			
WSD Sleeve	18"	27 1/4"	18"
Chassis	18 1/2"	30 1/2"	29"
Uni-Fit®			
USC Sleeve	17 7/8"	28"	19 1/4"
US Chassis	17 1/4"	27 3/4"	22 1/4"
UE Chassis	17 1/4"	27 3/4"	22 1/4"



Friedrich Air Conditioning Co. | 10001 Reunion Place, Suite 500 | San Antonio, TX 78216 | 877.599.5665 | www.friedrich.com

