

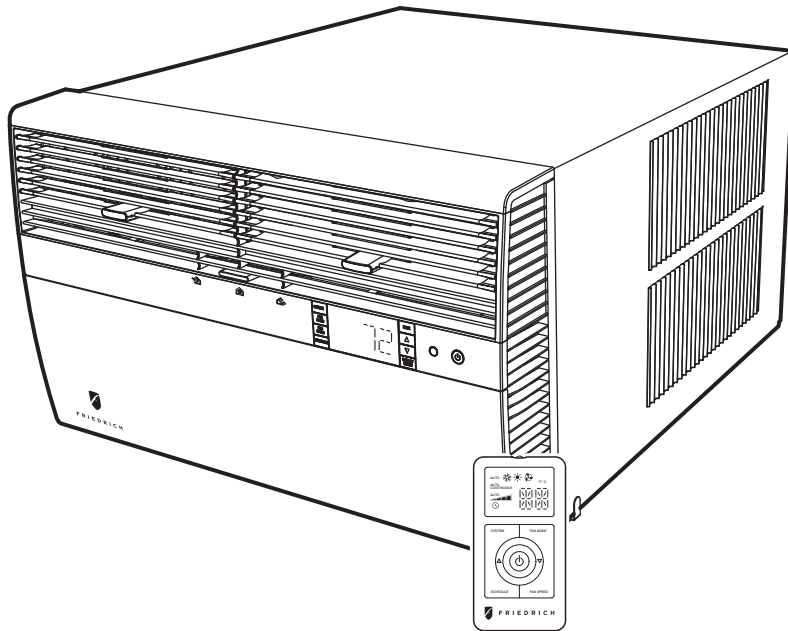

F R I E D R I C H

Room Air Conditioners



Standard Chassis R-410A Models

Cool Only

K ü h l

115-Volt: SS08M10, SS10M10, SS12M10, SS14M10
208-230-Volt: SS12M30, SS15M30, SM18M30, SM21M30
SM24M30, SL28M30, SL36M30

Cool with Electric Heat

K ü h l +

Electric Heat

208-230-Volt: ES12M33, ES15M33, EM18M34, EM24M35, EL36M35

Heat Pump with Electric Heat

K ü h l +

Heat Pump

208-230-Volt: YS12M33, YM18M34, YL24M35

Heat Pump

115-Volt: YS10M10

Table Of Contents

Important Safety Information	2-4
Introduction	5
Model and Serial Number Location	5
Unit Identification	6
Performance Data and Specifications	7
Installation Information/Sleeve Dimensions/Circuit Rating	8
Electrical Data	9
Before Operating the Unit	10
Control Panel Operation	11
Alerts	12-14
Remote Control Operation	15-16
Electronic Control System Maintenance Operation	17-20
Unit Operation	21
Cool-Heat Set Points	22
Electronic Control Sequence of Operation	23-29
Unit Operation with a Wall-Stat	29
Removing the Front Cover and Unit Chassis	30
Replacing the ID Coil Thermistor	31
Replacing the Control Board	31
Low Voltage Interface Connector	32
Replacing the ID Coil Thermistor	31
Remote Wall Thermostat	32-33
Airflow Selection and Adjustment	33
Components Testing	34-35
Refrigeration Sequence of Operation	36-37
Sealed Refrigeration System Repairs	38-41
Hermetics Components Check	42
Reversing Valve Description/Operation	43
Testing the Coil	44
Checking the Reversing Valve	44-45
Compressor Checks	46-47
Compressor Replacement	48-49
Routine Maintenance / Battery Check / Change	50-53
Service and Assistance	54
Performance Test Data Sheet and Sizing Guide	55
Error Codes and Alarm Status	56
Troubleshooting	57-66
Electronic Control Board Components Identification	67
Wiring Diagrams	68-75
Thermistors' Resistance Values	76
Remote Control Replacement Instructions	77-78
User Interface Service Kit	79
Instructions for Using Cooling Load Estimate Form	80
Cooling Load Estimate Form	81
Heat Load Form	82-83
Warranty	84

IMPORTANT SAFETY INFORMATION

The information contained in this manual is intended for use by a qualified service technician who is familiar with the safety procedures required for installation and repair, and who is equipped with the proper tools and test instruments required to service this product.

Installation or repairs made by unqualified persons can result in subjecting the unqualified person making such repairs as well as the persons being served by the equipment to hazards resulting in injury or electrical shock which can be serious or even fatal.

Safety warnings have been placed throughout this manual to alert you to potential hazards that may be encountered. If you install or perform service on equipment, it is your responsibility to read and obey these warnings to guard against any bodily injury or property damage which may result to you or others.

Your safety and the safety of others are very important.

We have provided many important safety messages in this manual and on your appliance. Always read and obey all safety messages.



This is a Safety Alert symbol.

This symbol alerts you to potential hazards that can kill or hurt you and others.

All safety messages will follow the safety alert symbol with the word "WARNING" or "CAUTION". These words mean:



You can be killed or seriously injured if you do not follow instructions.



You can receive minor or moderate injury if you do not follow instructions.

All safety messages will tell you what the potential hazard is, tell you how to reduce the chance of injury, and tell you what will happen if the instructions are not followed.



A message to alert you of potential property damage will have the word "NOTICE". Potential property damage can occur if instructions are not followed.

PERSONAL INJURY OR DEATH HAZARDS

ELECTRICAL HAZARDS:

- Unplug and/or disconnect all electrical power to the unit before performing inspections, maintenance, or service.
- Make sure to follow proper lockout/tag out procedures.
- Always work in the company of a qualified assistant if possible.
- Capacitors, even when disconnected from the electrical power source, retain an electrical charge potential capable of causing electric shock or electrocution.
- Handle, discharge, and test capacitors according to safe, established, standards, and approved procedures.
- Extreme care, proper judgment, and safety procedures must be exercised if it becomes necessary to test or troubleshoot equipment with the power on to the unit.

- Do not spray or pour water on the return air grille, discharge air grille, evaporator coil, control panel, and sleeve on the room side of the air conditioning unit while cleaning.
- Electrical component malfunction caused by water could result in electric shock or other electrically unsafe conditions when the power is restored and the unit is turned on, even after the exterior is dry.
- Never operate the A/C unit with wet hands.
- Use air conditioner on a single dedicated circuit within the specified amperage rating.
- Use on a properly grounded outlet only.
- Do not remove ground prong of plug.
- Do not cut or modify the power supply cord.
- Do not use extension cords with the unit.
- Follow all safety precautions and use proper and adequate protective safety aids such as: gloves, goggles, clothing, adequately insulated tools, and testing equipment etc.
- Failure to follow proper safety procedures and/or these warnings can result in serious injury or death.

REFRIGERATION SYSTEM REPAIR HAZARDS:

- Use approved standard refrigerant recovering procedures and equipment to relieve pressure before opening system for repair.
- Do not allow liquid refrigerant to contact skin. Direct contact with liquid refrigerant can result in minor to moderate injury.
- Be extremely careful when using an oxy-acetylene torch. Direct contact with the torch's flame or hot surfaces can cause serious burns.
- Make sure to protect personal and surrounding property with fire proof materials.
- Have a fire extinguisher at hand while using a torch.
- Provide adequate ventilation to vent off toxic fumes, and work with a qualified assistant whenever possible.
- Always use a pressure regulator when using dry nitrogen to test the sealed refrigeration system for leaks, flushing etc.
- Make sure to follow all safety precautions and to use proper protective safety aids such as: gloves, safety glasses, clothing etc.
- Failure to follow proper safety procedures and/or these warnings can result in serious injury or death.

MECHANICAL HAZARDS:

- Extreme care, proper judgment and all safety procedures must be followed when testing, troubleshooting, handling, or working around unit with moving and/or rotating parts.
- Be careful when, handling and working around exposed edges and corners of the sleeve, chassis, and other unit components especially the sharp fins of the indoor and outdoor coils.
- Use proper and adequate protective aids such as: gloves, clothing, safety glasses etc.
- Failure to follow proper safety procedures and/or these warnings can result in serious injury or death.

PROPERTY DAMAGE HAZARDS

FIRE DAMAGE HAZARDS:

- Read the Installation/Operation Manual for the air conditioning unit prior to operating.
- Use air conditioner on a single dedicated circuit within the specified amperage rating.
- Connect to a properly grounded outlet only.
- Do not remove ground prong of plug.
- Do not cut or modify the power supply cord.
- Do not use extension cords with the unit.
- Be extremely careful when using acetylene torch and protect surrounding property.
- Failure to follow these instructions can result in fire and minor to serious property damage.

WATER DAMAGE HAZARDS:

- Improper installation, maintenance or servicing of the air conditioner unit can result in water damage to personal items or property.
- Insure that the unit has a sufficient pitch to the outside to allow water to drain from the unit.
- Do not drill holes in the bottom of the drain pan or the underside of the unit.
- Failure to follow these instructions can result in damage to the unit and/or minor to serious property damage.

INTRODUCTION

This service manual is designed to be used in conjunction with the installation and operation manuals provided with each air conditioning system.

This service manual was written to assist the professional RAC (Room Air Conditioner) service technician to quickly and accurately diagnose and repair malfunctions.

This manual will deal with subjects in a general nature.

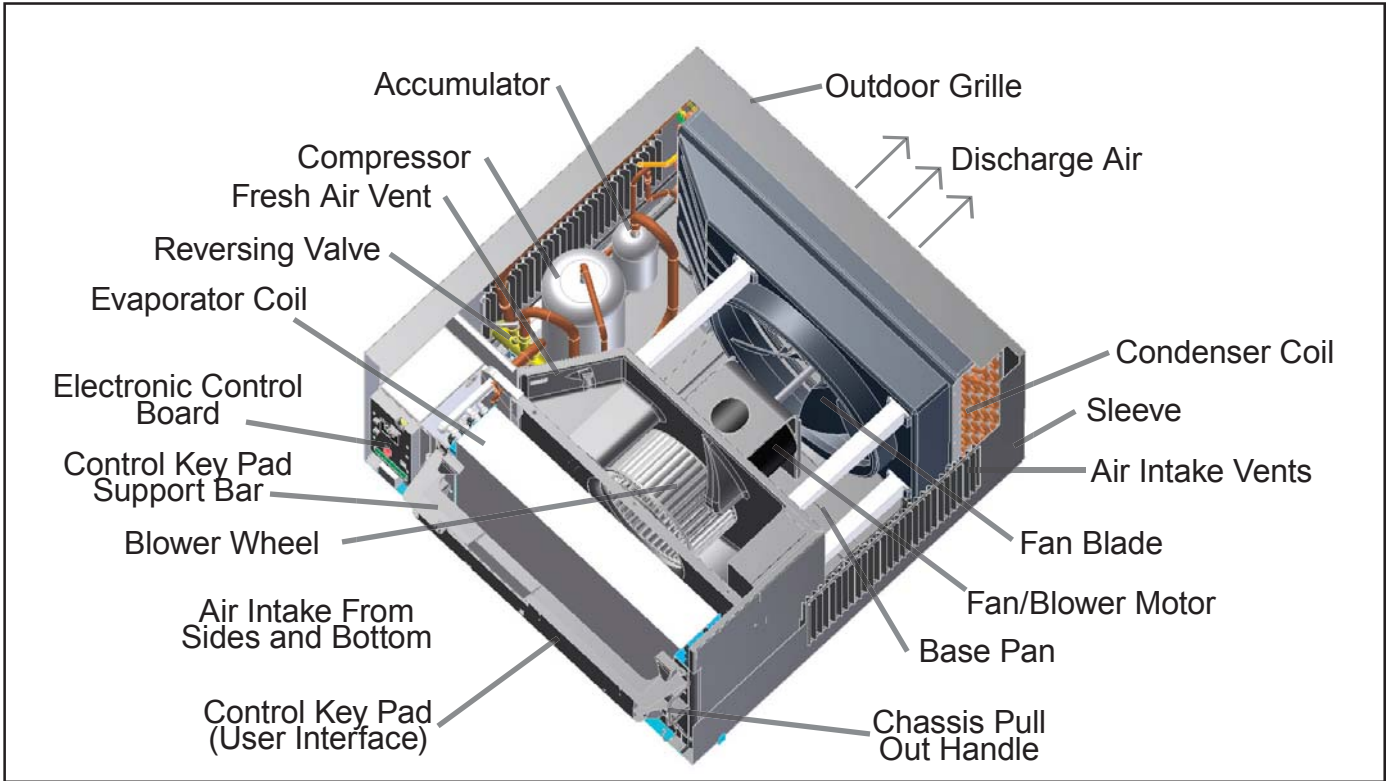

IMPORTANT: It will be necessary for you to accurately identify the unit you are servicing, so you can be certain of a proper diagnosis and repair (See Unit Identification code on page 6).

MODEL AND SERIAL NUMBER LOCATION

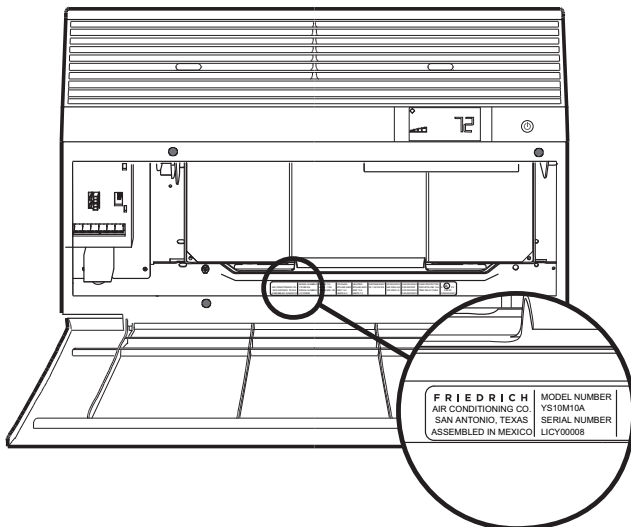

Register the air conditioner

Model information can be found on the name plate behind the front cover.

For your future convenience, record the model information here.

MODEL NUMBER

SERIAL NUMBER

PURCHASE DATE

UNIT IDENTIFICATION

Model Number Code

S S 08 M 1 0 A

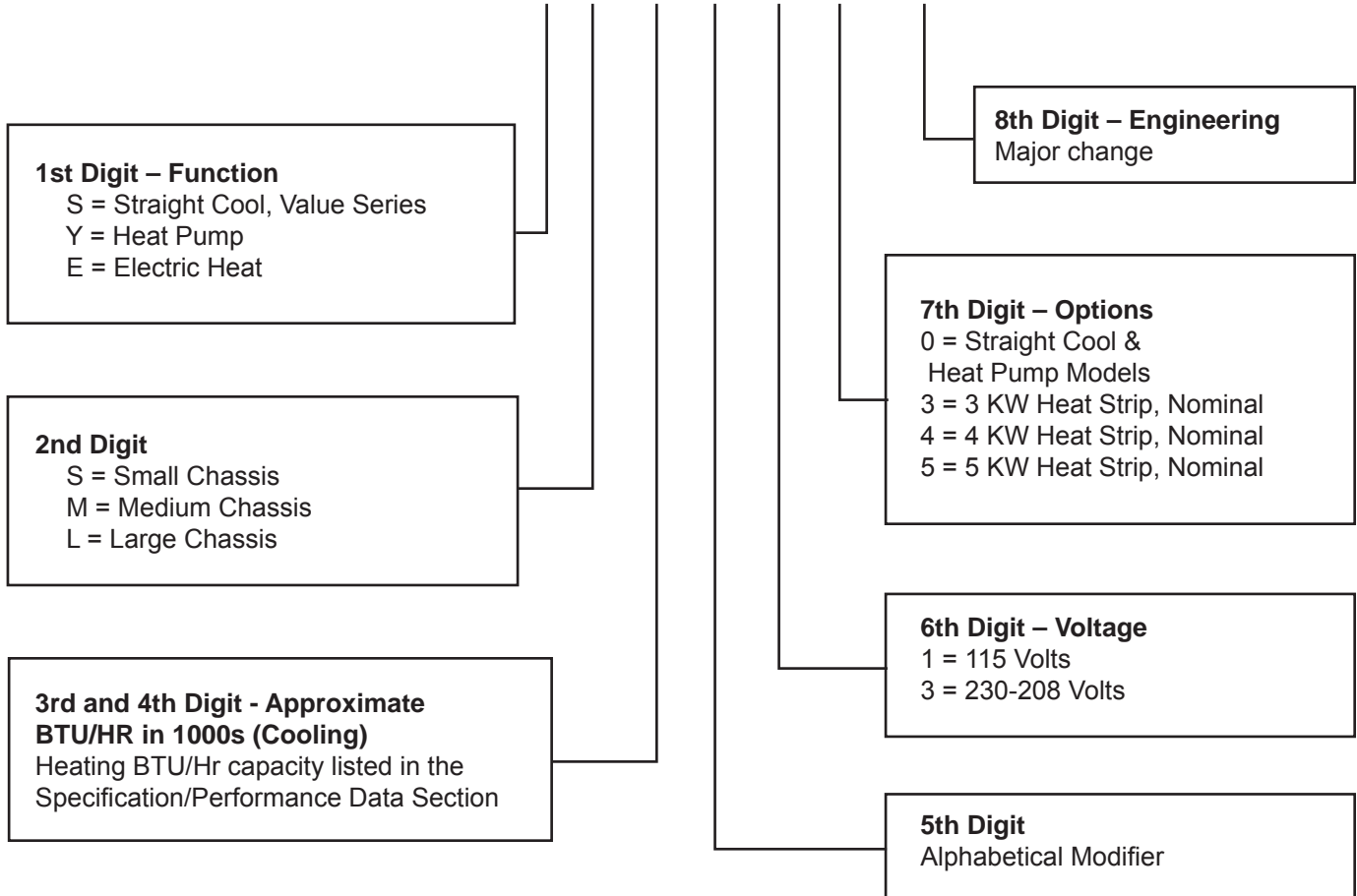

RAC Serial Number Identification Guide

Serial Number Decade Manufactured L=0 C=3 F=6 J=9 A=1 D=4 G=7 B=2 E=5 H=8	A	K	A	R	00001 Production Run Number
Year Manufactured A=1 D=4 G=7 K=0 B=2 E=5 H=8 C=3 F=6 J=9					Product Line R = RAC
Month Manufactured A=Jan D=Apr G=Jul K=Oct B=Feb E=May H=Aug L=Nov C=Mar F=Jun J=Sept M=Dec					

PERFORMANCE DATA

COOLING PERFORMANCE DATA*	EVAP. AIR TEMP. DEG. F		CONDENSER TEMP DEG. F	Discharge Temp	Suction Temp	Super Heat	Sub-Cooling	OPERATING PRESSURES		ELECTRICAL RATINGS			R-410A REF. Charge in OZ.	Voltage	BREAKER FUSE 60 Hertz Amps
	Discharge Air	Temp. Drop F.						Suction	Discharge	Amps Cool	Amps Heat	Locked Rotor Amps			
SS08M10-A	53	27	115	157	62	12	31	151	400	6.1		32.0	24.0	115	15
SS10M10-A	52	28	119	150	65	15	28	145	455	8.0		50.0	51.0	115	15
SS12M10-A	50	30	118	163	60	12	23	137	435	10.0		57.0	35.0	115	15
SS14M10-A	49	31	121	170	56	10	22	132	425	12.0		63.0	29.0	115	15
YS10M10-A	56	24	114	150	64	12	14	152	395	7.8	7.6	34.5	33.0	115	15
SS12M30-A	49	31	116	158	62	13	21	142	405	4.8		30.0	33.0	230/208v	15
ES12M33-A	51	29	115	158	62	13	18	140	400	4.8	16.0	30.0	33.0	230/208v	15
YS12M33-A	49	31	116	167	65	16	21	140	455	5.2	5.1	26.0	34.5	230/208v	15
SS15M30-A	53	27	121	171	62	14	28	138	430	6.4		32.0	32.5	230/208v	15
ES15M33-A	53	27	121	171	62	14	28	138	430	6.4	16.0	32.0	32.5	230/208v	15
SM18M30-A	54	26	122	160	62	9	31	145	450	7.4		42.0	55.0	230/208v	15
EM18M34-A	54	26	122	160	62	9	31	145	450	7.4	19.5	42.0	55.0	230/208v	30
YM18M34-A	50	30	118	168	60	15	24	130	410	8.5	8.5	44.0	49.5	230/208v	15
SM21M30-A	48	32	124	170	55	10	28	137	455	9.4		46.0	55.0	230/208v	15
SM24M30-A	46	34	129	179	55	12	34	123	495	11.0		47.0	40.0	230/208v	20
EM24M34-A	46	34	129	179	55	12	34	123	495	11.0		47.0	40.0	230/208v	30
YL24M34-A	56	24	121	176	62	18	25	135	480	11.1	12.2	47.0	74.0	230/208v	30
SL28M30-A	47	33	126	181	58	12	26	133	430	13.5		60.0	78.5	230/208v	20
SL36M30-A	51	29	129	188	56	12	31	122	470	19.0		96.0	77.0	230/208v	30

*Rating Conditions: 80 degrees F, room air temp. & 50% relative humidity, with 95 degree F, outside air temp & 40% relative humidity, all systems use R-410A.

SPECIFICATIONS

★ ENERGY STAR® qualified

Model	Cooling Capacity Btu	Heating Capacity Btu	Volts Rated	Cooling Amps	Cooling Watts	Heating Amps	Heating Watts	COP	Energy Efficiency Ratio EER	Estimated Yearly Operating Cost	Moisture Removal Pints/HR	Room Side Air Circulation CFM	Net Weight Sleeve Lbs
Kühl													
★ SS08M10	7900	—	115	6.1	677	—	—	—	11.7	\$54	1.0	265	S 99
★ SS10M10	9500	—	115	7.7	848	—	—	—	11.2	\$68	2.0	260	S 106
★ SS12M10	12000	—	115	10.0	1071	—	—	—	11.2	\$86	3.0	300	S 112
SS14M10	14000	—	115	12.0	1444	—	—	—	9.7	\$115	3.5	325	S 116
★ SS12M30	11700/11200	—	230/208	4.8/4.9	1026/982	—	—	—	11.4/11.4	\$82	2.8	275	S 112
SS15M30	14500/14300	—	230/208	6.4/6.8	1405/1385	—	—	—	10.3/10.3	\$112	3.5	360	S 116
★ SM18M30	17500/17200	—	230/208	7.4/8.0	1635/1617	—	—	—	10.7/10.7	\$131	4.6	350	M 140
★ SM21M30	20800/20700	—	230/208	9.4/10.3	2080/2070	—	—	—	10.0/10.0	\$166	6.0	425	M 132
★ SM24M30	23500/23300	—	230/208	11.2/11.9	2500/2479	—	—	—	9.4/9.4	\$200	10.0	390	M 152
★ SL28M30	27800/27000	—	230/208	13.5/14.4	2865/2812	—	—	—	9.7/9.6	\$229	8.5	600	L 193
SL36M30	36000/35700	—	230/208	19.0/20.5	4235/4200	—	—	—	8.5/8.5	\$338	12.0	725	L 212
Kühl + Heat Pump													
★ YS10M10*	9500	7500	115	7.8	812	7.6	743	3.0	11.7	\$65	1.9	285	S 109
★ YS12M33	12100/12100	9400/9000	230/208	5.2/5.4	1120/1120	5.6/5.8	1132/1139	2.4	10.8/10.8	\$89	3.0	265	S 115
★ YM18M34	18200/17800	15500/15400	230/208	8.5/8.9	1838/1798	8.5/8.7	1833/1761	2.6	9.9/9.9	\$147	5.4	370	M 141
★ YL24M35	24000/23600	23500/23200	230/208	11.1/12.0	2474/2433	12.2/14.3	2610/2575	2.6	9.7/9.7	†	7.0	600	L 197
Kühl + Electric Heat													
ES12M33	11700/11200	10700/8900	230/208	4.8/4.9	1026/982	16.0/14.7	3500/2900	3.3	11.4/11.4	\$82	2.8	275	S 113
ES15M33	14500/14300	10700/8900	230/208	6.4/6.8	1405/1385	16.0/14.7	3500/2900	3.0	10.3/10.3	\$112	3.5	360	S 117
EM18M34	17500/17200	13000/10600	230/208	7.4/8.0	1635/1617	19.5/17.0	4200/3500	3.1	10.7/10.7	\$131	4.6	350	M 141
EM24M34	23500/23300	13000/10600	230/208	11.2/11.9	2500/2479	19.5/17.0	4200/3500	3.1	9.4/9.4	\$200	10.0	390	M 153
EL36M35	36000/35700	17300/14300	230/208	19.0/20.5	4235/4200	24.0/22.4	5500/4650	2.5	8.5/8.5	\$338	12.0	725	L 213

* Operates on 115 volt and is not equipped with supplemental heat. Will not provide heat at temperatures below 40°F. Friedrich room air conditioners are designed to operate in outdoor temperatures from 60° F to 115° F.

Due to continuing research in new energy-saving technology, specifications are subject to change without notice.

As an ENERGY STAR® partner, Friedrich Air Conditioning Co. has determined that the selected ENERGY STAR® (★) models meet the ENERGY STAR® guidelines for energy efficiency.

The consumer- through the AHAM Room Air Conditioner Certification Program- can be certain that the AHAM Certification Seal accurately states the unit's cooling and heating capacity rating, the amperes and the energy efficiency ratio.

Estimated yearly operating cost based on a 2007 national average electricity cost of 10.65 cents per kWh. † The estimated yearly operating cost of this model was not available at the time the range was published.

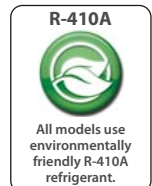

Installation Information / Sleeve Dimensions





Sleeve	Height	Width	Depth with Front	Shell Depth to Louvers	Minimum Extension Into Room*	Minimum Extension Outside*	Window Width		Thru-the-wall Installation Finished Hole		
			A	B			Minimum**	Maximum	Height	Width	Max. Depth C
S	15 15/16"	25 15/16"	29"	8 3/4"	5 3/4"	16 15/16"	27 3/8"	42"	16 3/16"	26 3/16"	7 3/8"
M	17 15/16"	25 15/16"	29"	8 3/4"	5 3/4"	16 15/16"	27 3/8"	42"	18 3/16"	26 3/16"	7 3/8"
L	20 3/16"	28"	35 1/2"	16 1/2"	5 3/8"	18 15/16"	29 7/8"	42"	20 3/8"	28 1/4"	15 1/8"

* Minimum extensions when mounted in a window.

** Minimum widths achieved using one side curtain assembly as opposed to both in a standard installation.

NOTE: S, M and L sleeves may be installed in window with no side kits if properly installed.

Circuit Rating/ Breaker

Model	Circuit Rating Breaker or T-D Fuse	Plug Face (NEMA#)	Power Cord Length (ft.)	Wall Outlet Appearance
SS08M10, SS10M10, SS12M10 and SS14M10. YS10M10.	125V - 15A	5 - 15P	6	
SS12M30, SS15M30, SM18M30 and SM21M30.	250V - 15A	6 - 15P	4	
SM24M30, SL28M30. ES12M33, ES15M33. YS12M33	250V - 20A	6 - 20P	4	
SL36M30. EM18M34, EM24M34, EL36M35. YM18M34 and YL24M35	250V - 30A	6 - 30P	4	

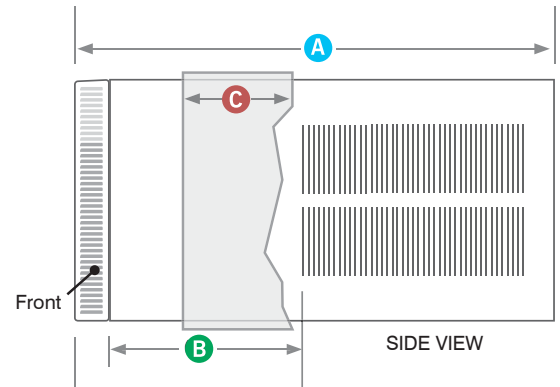

For the best cooling performance and highest energy efficiency

Keep the filter clean

Make sure that your air conditioner is always in top performing condition by cleaning the filter regularly.

Provide good air flow

Make sure the airflow to and from the unit is clear. Your air conditioner puts the conditioned air out at the top of the unit, and takes in unconditioned air at the bottom. Airflow is critical to good operation. It is just as important on the outside of the building that the airflow around the unit exterior is not blocked.

Unit placement

If your air conditioner can be placed in a window or wall that is shaded by a tree or another building, the unit will operate even more efficiently. Using drapes or blinds on the sunny side of the dwelling will also add to your unit's efficiency.

Insulation

Good insulation will be a big help in maintaining desirable comfort levels. Doors should have weather stripping. Be sure to caulk around doors and windows.

Proper installation of seal gasket

Make sure the seal gasket has been installed properly to minimize noise and improve efficiency. If the seal gasket has not been installed, please refer to the installation instructions.

ELECTRICAL DATA

⚠ WARNING	
	<p>ELECTRIC SHOCK HAZARD</p> <p>Turn off electric power before service or installation.</p> <p>All electrical connections and wiring MUST be installed by a qualified electrician and conform to the National Electrical Code and all local codes which have jurisdiction.</p> <p>Failure to do so can result in personal injury or death.</p>

NOTICE	
<p>FIRE HAZARD</p> <p>Not following the above WARNING could result in fire or electrically unsafe conditions which could cause moderate or serious property damage.</p> <p>Read, understand and follow the above warning.</p>	

- | | |
|----------------------|---|
| Wire Size | Use ONLY wiring size recommended for single outlet branch circuit. |
| Fuse/Circuit Breaker | Use ONLY the correct HACR type and size fuse/circuit breaker. Read electrical ratings on unit's rating plate. Proper circuit protection is the responsibility of the homeowner. |
| Grounding | Unit MUST be grounded from branch circuit through service cord to unit, or through separate ground wire provided on permanently connected units. Be sure that branch circuit or general purpose outlet is grounded. |
| Receptacle | The field supplied outlet must match plug on service cord and be within reach of service cord. Do NOT alter the service cord or plug. Do NOT use an extension cord. Refer to the table above for proper receptacle and fuse type. |



The consumer - through the AHAM Room Air Conditioner Certification Program - can be certain that the AHAM Certification Seal accurately states the unit's cooling and heating capacity rating, the amperes and the energy efficiency ratio.



*HACR: Heating Air Conditioning and Refrigeration

WARNING: Before Operating Your Unit

⚠ WARNING



Electrical Shock Hazard

Make sure your electrical receptacle has the same configuration as your air conditioner's plug. If different, consult a Licensed Electrician.

Do not use plug adapters.
Do not use an extension cord.
Do not remove ground prong.

Always plug into a grounded 3 prong outlet. Failure to follow these instructions can result in death, fire, or electrical shock.

Make sure the wiring is adequate for your unit.

If you have fuses, they should be of the time delay type. Before you install or relocate this unit, be sure that the amperage rating of the circuit breaker or time delay fuse does not exceed the amp rating listed in Table 1.

DO NOT use an extension cord.

The cord provided will carry the proper amount of electrical power to the unit; an extension cord may not.

Make sure that the receptacle is compatible with the air conditioner cord plug provided.

Proper grounding must be maintained at all times. Two prong receptacles must be replaced with a grounded receptacle by a certified electrician. The grounded receptacle should meet all national and local codes and ordinances. You must use the three prong plug furnished with the air conditioner. Under no circumstances should you remove the ground prong from the plug.

Test the power cord

All Friedrich room air conditioners are shipped from the factory with a Leakage Current Detection Interrupter (LCDI) equipped power cord. The LCDI device on the end of the cord meets the UL and NEC requirements for cord connected air conditioners.

To test your power supply cord:





1. Plug power supply cord into a grounded 3 prong outlet.
2. Press RESET (See Figure 1).
3. Press TEST, listen for click; the RESET button trips and pops out.
4. Press and release RESET (Listen for click; RESET button latches and remains in). The power cord is ready for use.

NOTICE

Do not use the LCDI device as an ON/OFF switch.

Failure to adhere to this precaution may cause premature equipment malfunction.

Once plugged in, the unit will operate normally without the need to reset the LCDI device. If the LCDI device fails to trip when tested or if the power supply cord is damaged, it must be replaced with a new power supply cord from the manufacturer. Contact our Technical Assistance Line at (800) 541-6645. To expedite service, please have your model number available.

MODEL	CIRCUIT RATING OR TIME DELAY FUSE		REQUIRED WALL RECEPTACLE	
	AMP	VOLT	NEMA NO.	
SS08M10, SS10M10, SS12M10, SS14M10, YS10M10	15	125	5-15R	
SS12M30, SS15M30, SM18M30, SM21M30	15	250	6-15R	
SL25M30, SL28M30, ES12M33, ES15M33, YS12M33	20	250	6-20R	
SL36M30, EM18M34, EL25M35, EL36M35, YM18M34, YL24M35	30	250	6-30R	

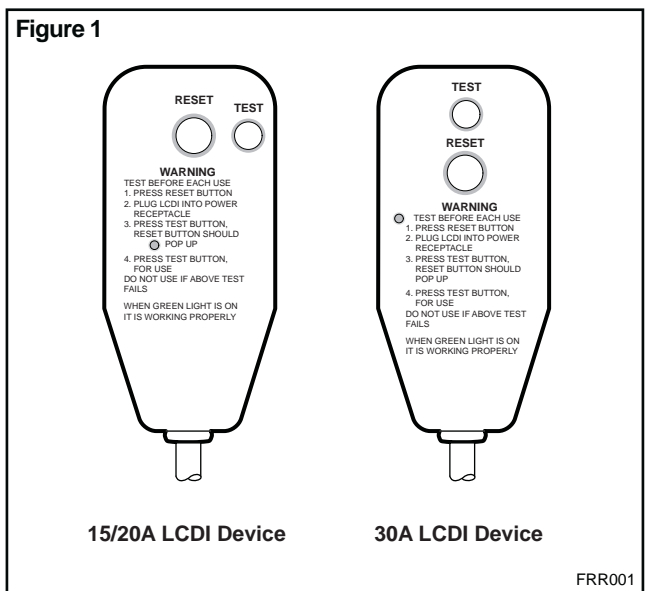

Control Panel Operation

Let's check out how to control your air conditioner. On the control panel, just to the left of the POWER (⏻), is a liquid crystal display (LCD). All of the control panel function buttons and mode icons can be viewed in Figure 1.

Power On – Press the (⏻) button to turn on the air conditioner. The power button will illuminate to indicate the power is on. The backlight on the power switch will automatically dim to 20% intensity after 120 seconds of inactivity. The remote control can also be used to turn power ON / OFF (See Remote Control).

Display – The display is a high efficiency LCD with a built-in white back light. The back light has an automatic two (2) step dim function. After 120 seconds of inactivity, the display dims to 20% intensity. After an additional 120 seconds, the display switches off. Touching buttons will automatically bring the display to full brightness.

There are four control push buttons on each side of the display.

SYSTEM Button – Allows the user to sequentially select, **AUTO** Cool ❄️, **HEAT** 🔥, and **FAN ONLY** 🌀 operation. Press the **SYSTEM** button and the display advances to the next mode. A new icon appears. At the same time, the mode displays for two (2) seconds, then returns the display to the temperature set point for modes other than FAN. Note that on cool only units, there are no **HEAT** 🔥 and **AUTO** modes.

FAN MODE Button – Selects between automatic **AUTO** or **CONTINUOUS** operation. In the **AUTO** mode, the fan only turns on and off when the compressor operates or the heat function is enabled.

In the **SYSTEM FAN ONLY Mode**, **AUTO** is not available. In the **CONTINUOUS** mode, fans speed is determined by your selection on the **FAN SPEED** button.

FAN SPEED Button – Used to sequentially select between fan speeds. Depending on your model, you can select between LOW, MED, HIGH, and MAX and AUTO. Max setting not available on SL and Kuhl+ models. When the **FAN SPEED** button is pressed, the fan speed is temporarily displayed in the display window, plus a fan speed icon (triangle) changes to indicate the new speed level. When auto is selected, fan speed automatically varies depending on the set temperature on the control panel and the actual room temperature. Let me explain. Say for example you're working in your garage and you need to open the big door for several minutes. The air conditioner will sense a wide difference between the set temperature and the actual room temperature when this occurs the system fan speed increases to MAX. The fan speed decreases (in step) as the temperature difference decreases. When the set point temperature is reached the FAN speed returns to the original setting.

SCHEDULE Button – The **SCHEDULE** button turns the schedule function on and off. The current day of the week is indicated as a dot underneath the day symbol. Pressing the **SCHEDULE** button a second time turns the schedule function off. The schedule function comes preprogrammed with recommended energy savings values (Addendum 1). The values may be changed through the schedule program function (See Programmable Thermostat).

UP and DOWN arrows – Pressing either **▲** (UP) or **▼** (DOWN) button changes the desired room temperature. The factory preset lower and upper limits are 63° F (16° C) and 99° F (37° C). These buttons are also used to navigate between function options when using the User Menu or Maintenance Mode.

BACK Button – This button is used after a menu item has been selected. It takes the user back to the previous menu level and to save and exit.



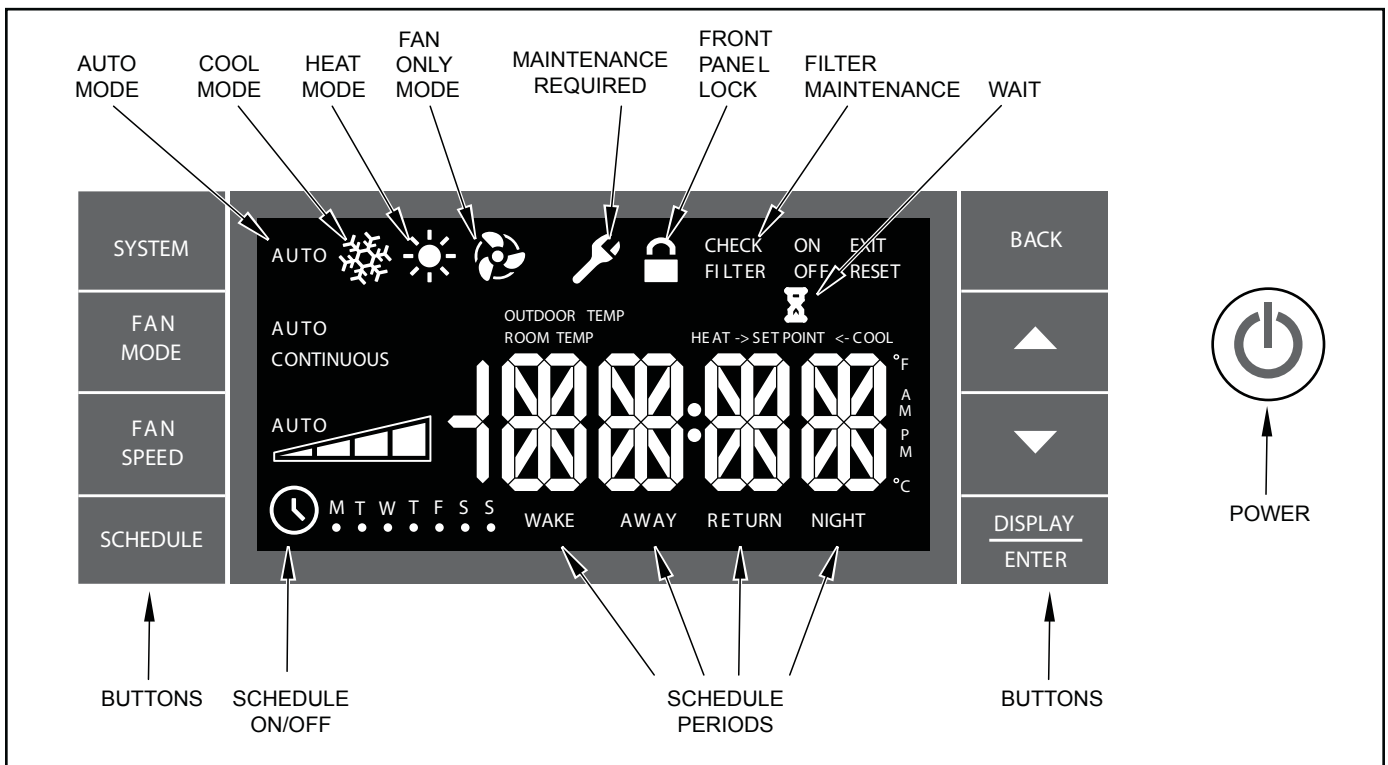

DISPLAY/ENTER Button – This button is used in conjunction with User Menu and Maintenance Mode operation to select items. This button may also be used to alternatively display the ROOM TEMPERATURE, OUTDOOR TEMPERATURE, and TIME. If the display is left inactive for 10 seconds it will reset to the TEMPERATURE SET POINT.



Figure 1



ALERTS (The control system has five (5) customer alerts)

CHECK FILTER – When the filter needs to be checked, an icon  appears on screen. The word “RESET” appears next to the **BACK** button. The **CHECK FILTER** alert is issued when the fan run time is greater than 500 hours. This alert may be reset by the user (Refer to Special Functions, Filter Reset).



Maintenance Required – When maintenance is required, a service icon  appears on screen. This icon will not be dismissed until maintenance has been performed. If the service icon  flashes, maintenance is required and must only be performed by qualified service personnel. When the icon  is on standby the system has sensed an abnormal condition. For example: The air in/out louvers may be blocked. Once proper air flow is established the service icon  goes away.

Wait – The WAIT icon  illuminates when the compressor lockout is active. Whenever the compressor shuts off, system pressures must be allowed to equalize. At this time, an internal timer begins a count-down from up to 240 seconds. If a demand for heat or cool occurs during this count-down the WAIT icon  displays letting you know that the compressor will not operate until the count-down has completed. This timer prevents damage to the unit if it tries to start too quickly after it stops running. Normally the WAIT icon  is off. Once the timer has cleared, the air conditioner will heat or cool based on the temperature setting. Electric heat is not affected by this timer.

Protection Alert (Freeze) – If the room freeze protection is active, the display indicates this by showing Room Freeze Protection “FRZ”. Once the condition is satisfied, the “FRZ” display is removed. If the room temperature is less than 40° F (4° C), and the air conditioner is equipped with electric heat, the room freeze protection will activate. The air conditioner will run high fan and electric heat until the room temperature reaches 46° F (8° C). Pressing the **BACK** button delays the freeze protection function for five (5) minutes.



Low Battery – When the battery is low a warning display **BATT** will be inserted before other messages such as “COOL”. If the Low Battery **BATT** alert is on, the battery in the control unit must be changed. Refer to the changing the battery procedure. Once the battery is changed, the alert message will go off. Refer to Troubleshooting Tips. Under normal conditions the battery life should be greater than 7 years.

Special Functions



Panel Lock  – The front panel push buttons can be locked to prevent inadvertent operation. To lock the front panel, press and hold the **SCHEDULE** + **DISPLAY ENTER** buttons for three (3) seconds. A double beep indicates your mode change was successful and a  icon appears on the display. To unlock the display, press and hold the **SCHEDULE** + **DISPLAY ENTER** buttons for three (3) seconds. The  icon will no longer be visible.

Filter Reset – If the **CHECK FILTER** icon displays, the timer may be reset by pressing and holding the **BACK** button for three (3) seconds. A beep indicates the **CHECK FILTER** system timer was reset and the **CHECK FILTER** icon and the word “RESET” will no longer be visible.



User Menu Functions – The User Menu Functions allows you to change the following selections: Set TIME, 12/24 Hour Clock Format, BEEP ON / OFF, DIM ON / OFF, Emergency Heat (EMTH) ON / OFF, Auto BAND Adjust, F / C Select, FRZ ON / OFF, Temp Offset (TO) and the Automatic Temperature Sensing Feature (ATSF).

To enter the User Menu, press and hold **DISPLAY ENTER** for 3 seconds, the TIME selection appears. Use the  (UP) or  (DOWN) buttons to scroll through the User Menu. Press the **DISPLAY ENTER** button to enter the displayed function. If left inactive for 15 minutes the User Menu display will no longer be visible and it returns to normal operation mode display. To manually exit the User Menu, press the **BACK** button.





The hour digits flash first. The user presses the  or  to change the hours. To change AM-PM, the hours must be advanced 12 hours. Press the **DISPLAY ENTER** key to change to the minutes. To exit the selection process, user presses the **BACK** key which will go to the time screen.









The minutes digits flash. The user presses the  or  to change the minutes. Press the **DISPLAY ENTER** key to change the days. To exit the selection process, the user presses the **BACK** key which will go to the time screen.







The dot underneath the days of the week begins to blink to indicate which day it is. If the user has not set the date before, the dot starts on Monday. If the user is making a correction to previously set information the dot appears under whichever day the unit thinks it is. The user can press  or  to move the dot left or right (respectively) along the week. The user presses **DISPLAY ENTER** to loop back to the hours setting. To exit the selection process, the user presses the **BACK** key which will go to the time screen.



Tuesday has been selected. The user presses **DISPLAY ENTER** to loop back to the hours setting. To exit the selection process and accept the changes, the user presses the **BACK** key which will go to the time screen.

Time Setting – When in the User Menu, on the Control Panel, use the  (UP) and  (DOWN) to select TIME. Push **DISPLAY ENTER**, the hours segment flashes. Use the  (UP) and  (DOWN) to set the hour, then push **DISPLAY ENTER**. The minutes segment flashes. Use the  (UP) and  (DOWN) to set the minutes, then push **DISPLAY ENTER**.

NOTE: If the AM or PM indicator is incorrect, push **DISPLAY ENTER** until the hours segment flashes, use the  (UP) or  (DOWN) to advance the hour segment 12 hours, then push **DISPLAY ENTER**. The day of the week displays. Use the  (UP) or  (DOWN) to select the current day. Press the **BACK** key to save and go back to the TIME screen. Press  (UP) to go to the next menu 1224.

NOTE: Pressing the **BACK** button again will exit the user menu function mode. Or simply leave the control inactive for 15 minutes and the control will return back to normal operation.



User presses ▲ or ▼ to toggle the format between 12HR and 24HR display. To exit the selection process and accept the change, press the BACK key.

Clock Type – You may select between a 12 hr and 24 hr clock. When 1224 is displayed press the DISPLAY ENTER key then press ▲ (UP) or ▼ (DOWN) to toggle between 12 hr and 24 hr clock. To accept the change, press the BACK key to return to the 1224 screen. Press the ▲ (UP) to go to the next menu BEEP.



User presses ▲ or ▼ to toggle between Beep On and Beep Off. Press the BACK key to accept the change and exit the selection process.

Audible Alerts – You can select to have the control beep when entering menus. When BEEP is displayed press the DISPLAY ENTER key then press ▲ (UP) or ▼ (DOWN) to toggle between ON and OFF. To accept the change, press the BACK key to return to the BEEP screen. Press the ▲ (UP) to go to the next menu EMHT on Kühl+ models or F C for Kühl models.



User presses ▲ or ▼ to select between AUTO, DM 20, OFF. Press the BACK key to accept the change and exit the selection process.

The Dim Auto automatically dims the display to 20% and then turns it off after a period of time. The Dim 20 setting behavior is similar to AUTO, but prevents the display from turning off. Minimum brightness is 20%. The Dim Off setting forces the display to run at full brightness.



User presses ▲ or ▼ to toggle between Emergency Heat On and Emergency Heat Off. Press the BACK key to accept the change and exit the selection process.

Emergency Heat – The Kühl+ heat pump models (YS, YM, YL) have a special feature that is designed to keep the unit providing heat. When EMHT is displayed press the DISPLAY ENTER key then press ▲ (UP) or ▼ (DOWN) to toggle between ON and OFF.

To accept the change, press the BACK key to return to the EMHT screen. Press the ▲ (UP) to go to the next menu BAND.

In the unlikely event of a compressor failure, the heat pump unit may be switched to operate in the electric heat mode only until repairs can be made.



The menu allows the user to adjust the minimum spread between the Auto Cool set point and the Auto Heat set point. Press the ▲ or ▼ key to adjust. The adjust range is 3 to 10.

Auto Changeover 'Dead Band' – A buffer Zone between heating and cooling in which no conditioning occurs. For Kühl+ models with the auto changeover feature you can select the temperature band between heating and cooling. From the factory the band is set at 3° F (-16° C). The band is adjustable from 3° F (-16° C) to 10° F (-12° C). When BAND is displayed press the DISPLAY ENTER key then press ▲ (UP) or ▼ (DOWN) to toggle between 3 and 10. To accept the change, press the BACK key to return to the BAND screen. Press the ▲ (UP) to go to the next menu F C.



User presses ▲ or ▼ at the same time to toggle between Fahrenheit or Celsius as their temperature unit of choice. Press the BACK key to accept the change and exit the selection process.

Fahrenheit / Celsius Selection – You may select between displaying temperature in F or C. When F C is displayed press the DISPLAY ENTER key then press ▲ (UP) or ▼ (DOWN) to toggle between F and C. To accept the change, press the BACK key to return to the F C screen. Press the ▲ (UP) to go to the next menu FRZ.



User presses ▲ or ▼ to select between Freeze Protection On & Freeze Protection Off. Press the BACK key to accept the change and exit the selection process.

Freeze Protection – The Kühl+ models have a special feature that is designed to keep the interior space above freezing by energizing the electric heater anytime the indoor room temperature falls to 40° F (4° C). With the freeze protection feature turned on, when the unit senses the indoor temperature fall to 40° F (4° C) the unit will run the heater and high fan until the space reaches 46° F (8° C) When FRZ is displayed press the DISPLAY/ENTER key then press ▲ (UP) or ▼ (DOWN) to toggle between ON and OFF. To accept the change, press the BACK key to return to the FRZ screen. Press the ▲ (UP) to go to the next menu TO.



User presses ▲ or ▼ to increment/decrement the temperature offset (TO) for the room temperature sensor. (Maximum offset = +/- 8 degrees F). Press the BACK key to accept the change and exit the selection process

Temperature Offset – In some cases the built in thermostat on the unit may not display the temperature as it is felt in the room. This can be caused by many things including the size of the unit, the heat load on the room or other factors. Friedrich allows you to select the appropriate temperature offset to make the temperature readout as accurate as possible for your application. In many cases the factory 0° F (-18° C) offset will provide an accurate temperature readout. To change the offset follow these instructions. When TO is displayed press the DISPLAY/ENTER key then press ▲ (UP) or ▼ (DOWN) to toggle between 0° F (-18° C) and 8° F (-13° C). In most instances an offset from 0° F (-18° C) to 2° F (-17° C) is all that is necessary. To accept the change, press the BACK key to return to the TO screen. Press the ▲ (UP) to go to the next menu ATSF.

You may cycle through the menus using the ▲ (UP) or ▼ (DOWN) keys to access any of the menus.



User presses ▲ or ▼ to select between ATSF On or Off. Press the BACK key to accept the change and exit the selection process.



Automatic Temperature Sampling Feature - The automatic temperature sampling feature maintains a balanced temperature throughout the room by circulating the air for 30 seconds once every 9 minutes that the unit is not running when it is set to cooling or heating mode. By circulating the air the unit can detect hot or cold areas in the room and operate the unit to cool or warm the room as necessary. This function is only available when the fan mode is set to 'AUTO' or in COOL or HEAT Mode. (Heating function only available on Kuhl+ units)



For display only. No user selectable options.



Firmware Version - When VER is displayed press Display / Enter key. The firmware version is displayed as left digit (Major) and right digit (Minor). This version number should be used along with Model and Serial numbers for service.

DIGITAL CONTROL PANEL'S ACCESS CODES SUMMARY

Key Sequence	Action
Filter Reset	Press BACK key for 3 sec+ play double beep (🔔)
Enter User Menu	Press DISPLAY/ENTER key for 3 sec+ play double beep (🔔)
Enter Maintenance Menu	Press SYSTEM + SCHEDULE + BACK + DISPLAY/ ENTER for 3 sec+ play double beep (🔔)
Schedule ON/OFF	Press SCHEDULE once each time
Enter & Exit Schedule Programming	Press SCHEDULE for 3 sec+ play double beep (🔔)
Reset Error Codes & Error History	Press ▲ + ▼ for 3 sec+ play double beep (🔔)
Lock Control Panel	Press SCHEDULE + DISPLAY/ENTER for 3 sec+ play double beep (🔔)



Remote Control Operation

Remote Control – Refer to Figures 11 and 12 during operation description.

Getting Started – Install two (2) AAA batteries in the battery compartment located on the back of the unit.

Operation – The remote control should be within 25 feet of the air conditioner for operation (Refer to Figure 10 for effectiveness). Press the  button to turn the remote on. The remote will automatically power off after 15 seconds if the buttons are not being pressed. The remote must be on to control the unit.

POWER Button – Turns remote and unit on and off.



SYSTEM Button – Allows the user to sequentially select, **AUTO** Cool , **HEAT** , and **FAN ONLY**  operation. When the button is pressed, the display indicates which mode has been selected via a display message. Note that when the heating function is not available, the system will automatically skip the HEAT and AUTO modes.

FAN MODE Button – Selects between automatic (**AUTO**) or **CONTINUOUS** operation. In the AUTO mode, the fan only turns on and off when the compressor operates or the heat function is enabled.

NOTE: AUTO is not available in the FAN ONLY Mode, the display indicates **CONTINUOUS**. In the **CONTINUOUS** mode, fan speed is determined by your selection on the **FAN SPEED** button.

FAN SPEED Button – Used to sequentially select new fan speed, plus AUTO operation. When the **FAN SPEED** button is pressed, the fan speed is temporarily displayed in the display window, plus a fan speed icon (triangle) changes to indicate the new speed level. Fan speed automatically varies depending on the set temperature on the control panel and the actual room temperature. Let me explain. Say for example you're working in your garage and you need to open the big door for several minutes. Since there is a big difference between your set temperature and the actual room temperature the system fan speed increases to MAX. It remains at this speed until the room temperature matches the set temperature.

SCHEDULE Button – The **SCHEDULE** button turns the schedule function on and off. Pressing the **SCHEDULE** button a second time turns the schedule function off. Only the schedule icon  will be displayed.

UP and DOWN Arrows – Pressing either the  (UP) or  (DOWN) button changes the desired room temperature. The factory preset lower and upper limits are 60° F (16° C) and 99° F (37° C). These buttons are also used to navigate between function options when using the User Menu or Maintenance Mode.

Remote Effectiveness

Hand Held Remote – Has an operating range of up to 25 ft. The infrared remote control signal must have a clear path to transmit the command to the air conditioning unit. The remote signal has some ability to "bounce" off of walls and furniture similar to a television remote control. The diagram below shows the typical operating range of the control in a standard room with 8 ft high ceilings.

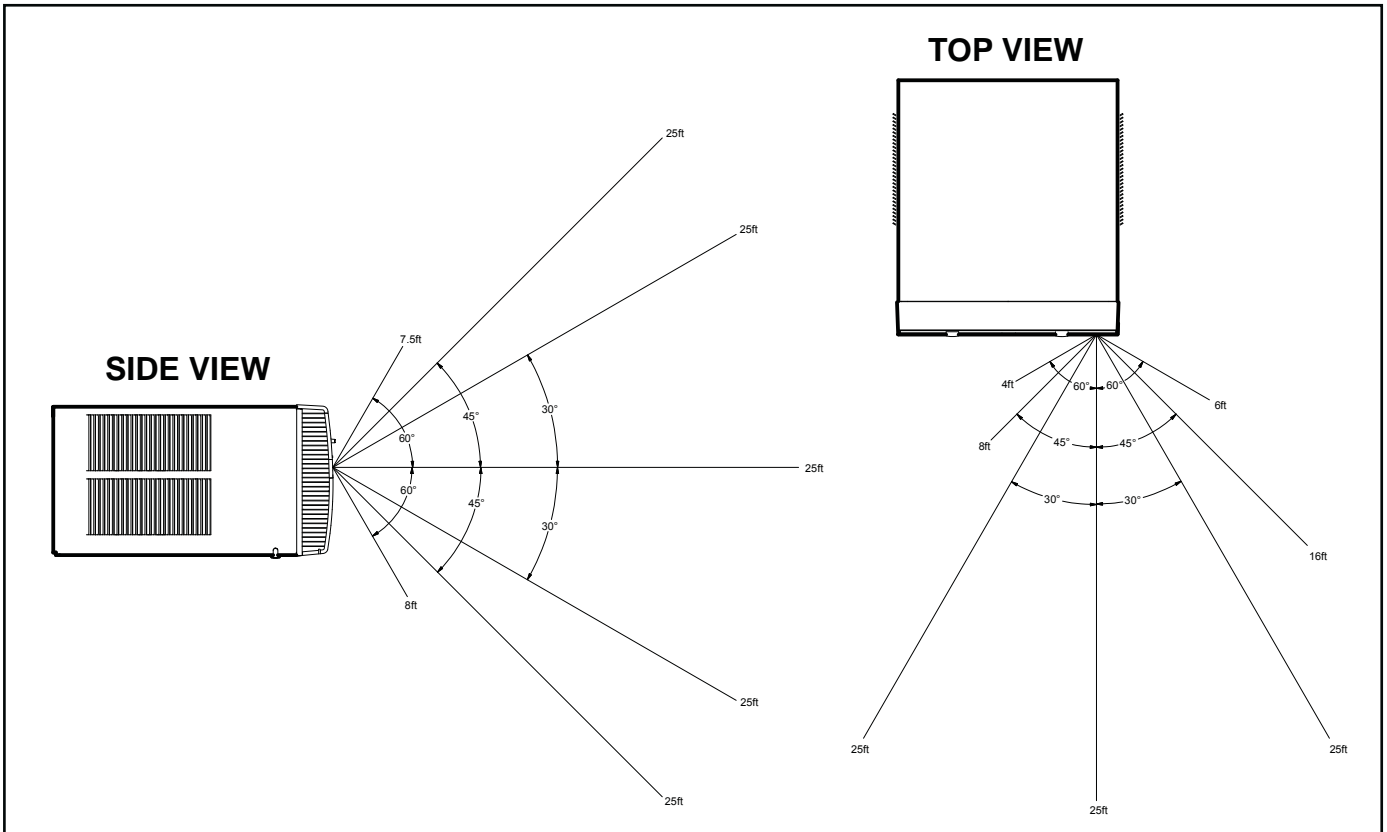

Changing Temperature from F° (Fahrenheit) To C° (Celsius) or Reverse

Be within 25' of unit with the remote control. Press the SYSTEM and FAN MODE buttons at the same time and hold for 3 seconds. The display will show the temperature in Celcius. Do the same to reverse temperature to F° (Fahrenheit).

Remote Control Operation (Continued)

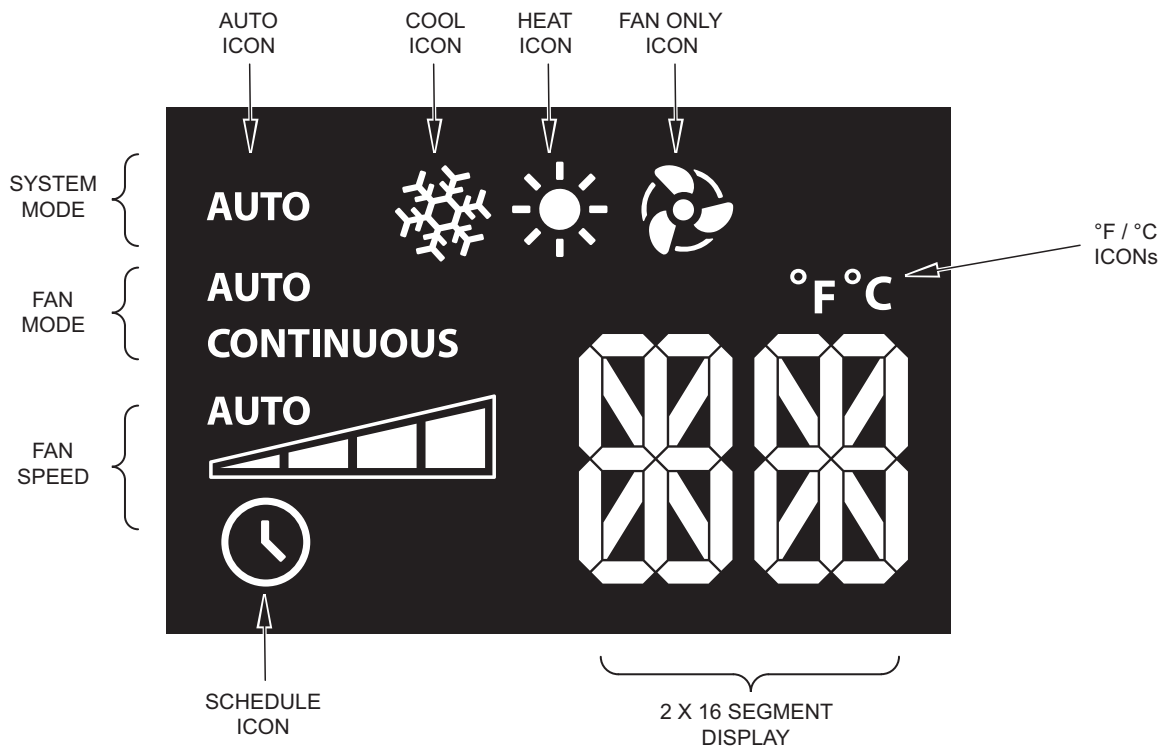
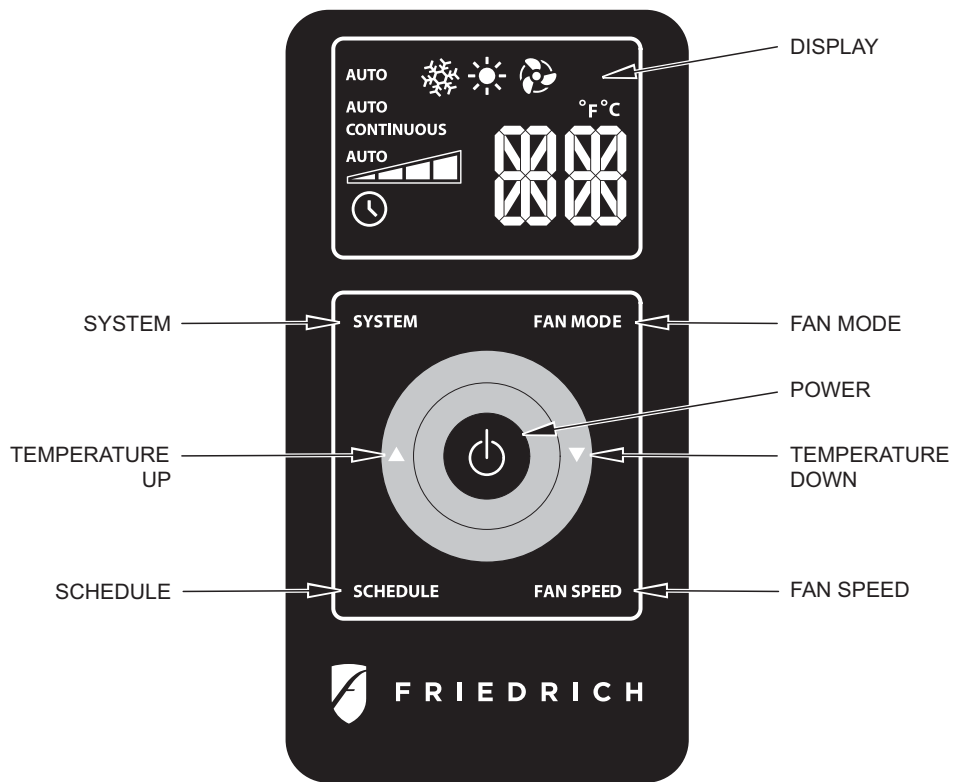

ELECTRONIC CONTROL SYSTEM MAINTENANCE

Introduction

This section contains information on the maintenance alerts, temperature limiting, diagnostic test and how to access. The electronic control system has a built in maintenance sub system which works constantly behind the scenes to help identify problems with the air conditioner or control system. When maintenance is required, a service icon appears on the display screen.

This icon  will not be dismissed until maintenance has been performed or the problem cleared.

Note: The wrench icon may be on steady or flash, depending on severity. Maintenance should only be performed by qualified service personell.

Display

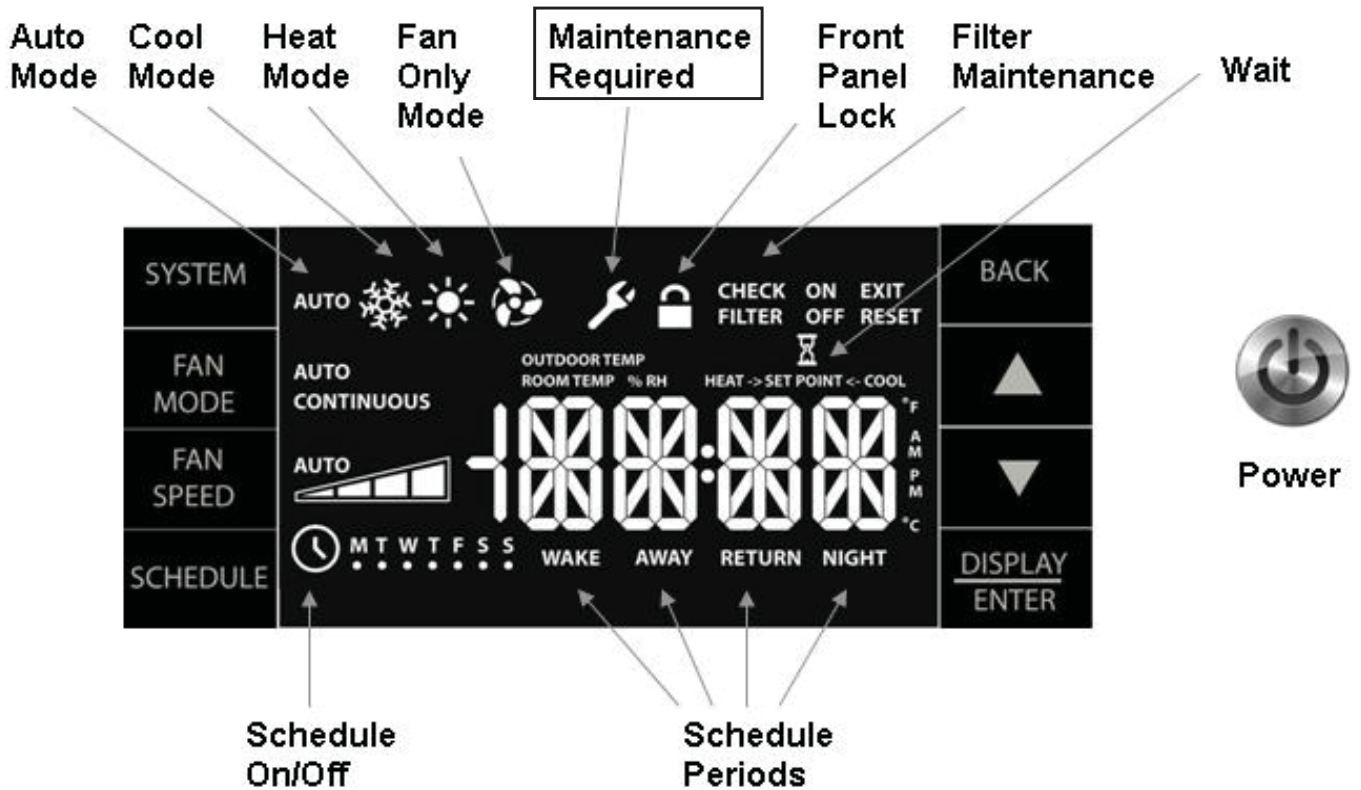

Testing the Display

Press the FAN MODE and FAN SPEED buttons at the same time for 3 seconds. All of the display's icons and functions should light up. If any of them do not light up, the display should be replaced. When the buttons are released, the display reverts to the original display.

Electronic Control System Maintenance Operation

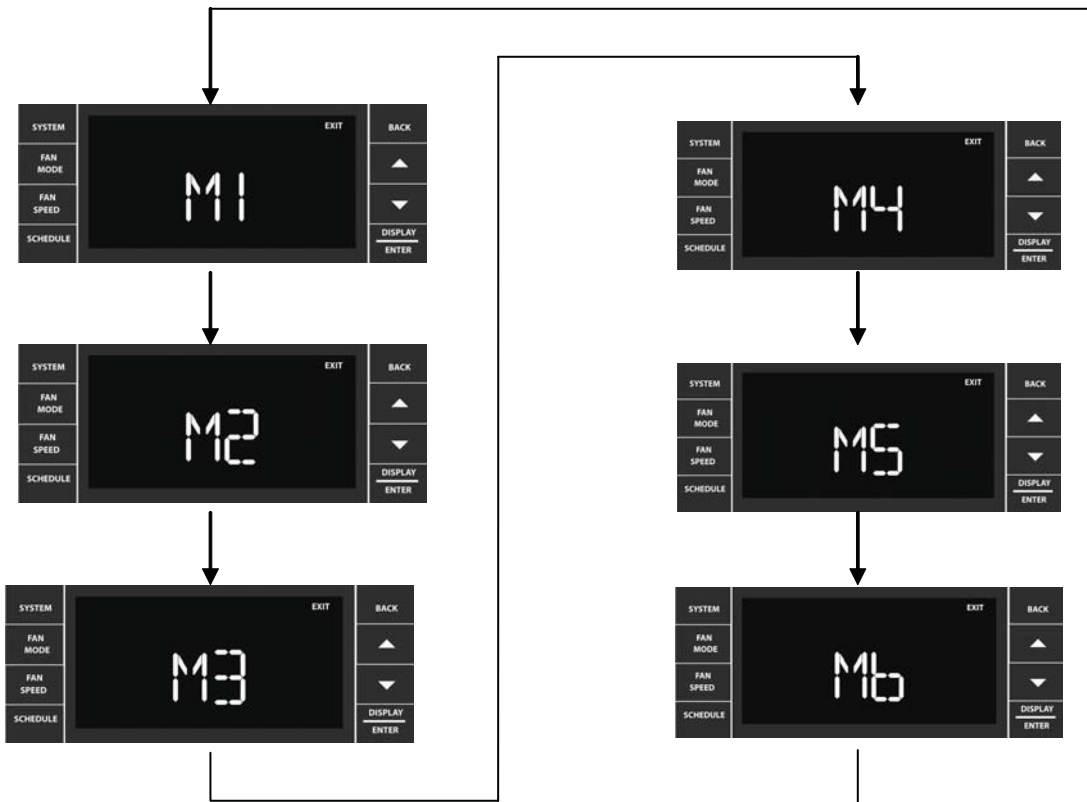

To Enter the Maintenance Section:

Press **SYSTEM+SCHEDULE+BACK+DISPLAY/ENTER** for 6 seconds.

There are 5 maintenance sub-menus **M1** through **M5**.

Maintenance Sub-Menus

- M1 – Temperature High Limit
- M2 – Temperature Low Limit
- M3 – Test Mode Access
- M4 – Provision Switch Setting & State
- M5 – Alarms & History
- M6 – Factory Use Only

Access

- Service Only
- Service Only
- Service Only
- Factory Use Only
- Service Only
- Factory Use Only

Pressing the ▼ or ▲ key cycles through the sub-menus. Press DISPLAY/ENTER to enter a sub-menu. The BACK key is used to exit the menu. **Extreme care must be taken when modifying parameters in the maintenance menus.**

Temperature High Limit

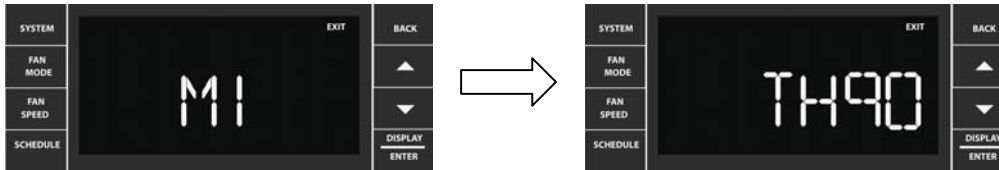

Maintenance function 1 is ready to be selected. Press DISPLAY/ENTER to access the function.

User presses ▲ or ▼ to increment or decrement the upper temperature limit. 99°F is the maximum upper limit. The current stored high limit is displayed when the screen is selected. Press the BACK key to accept the value, and exit the sub-menu to the M1 screen.

Temperature Low Limit

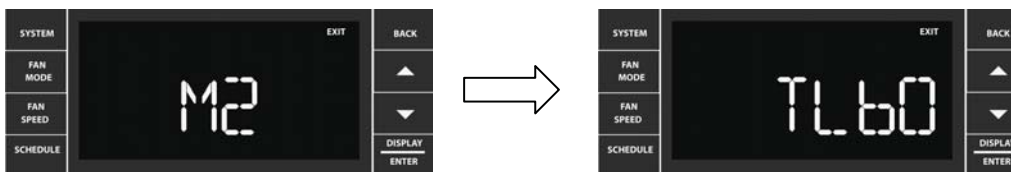

Maintenance function 2 is ready to be selected. Press DISPLAY/ENTER to access the function.

User presses ▲ or ▼ to increment or decrement the lower temperature limit. 60°F is the minimum lower limit. The current stored lower limit must be displayed when the screen is selected. Press the BACK key to accept the value, and exit the sub-menu to the M2 screen.

M3 – Test Mode Access

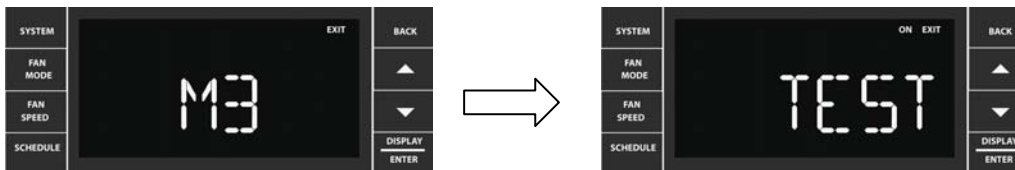

Maintenance function 3 is ready to be selected. Press DISPLAY/ENTER to access the function.

User presses the ▼ or ▲ key to toggle the Test Mode ON/OFF. Press the BACK key to accept the change and exit the sub-menu to the M3 screen.

This test selects the system mode of operation directly.

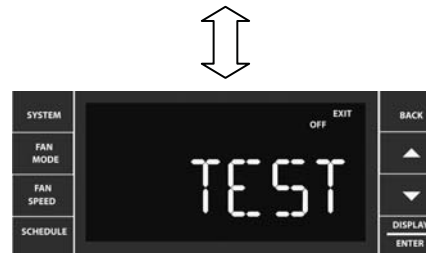

The Following functions Can be Tested

1. System Mode: Cool/Heat Pump Compressor, Electric Heat, Fan Only
2. Fan operation and speeds

Test mode Bypasses:

1. Compressor lock out (time delay)
2. All relay switch's delays
3. All thermistors delay
4. Automatic heat/cool changeover delay
5. System settings

If M3 switch is left ON it will reset to OFF automatically after 15 minutes of inactivity.

M4 – Switch Access (Unit Configuration)

FACTORY USE ONLY



M5 – Error Codes & History

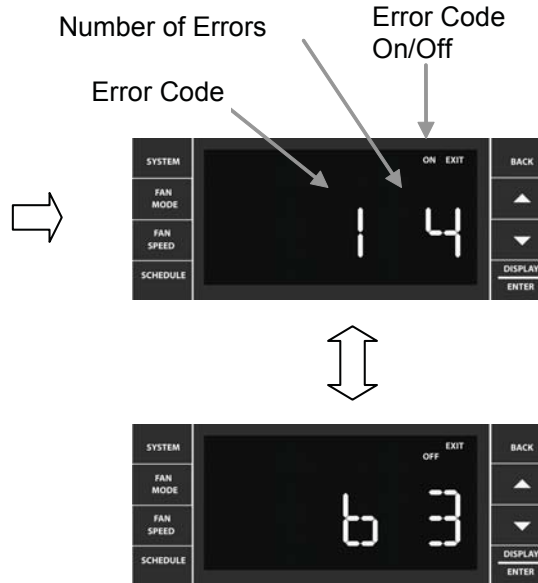

Maintenance function 5 is ready to be selected. Press DISPLAY/ENTER to access the function.

The error code display shows the error code number on the left, and the error code history on the right. User presses the ▲ or ▼ keys to cycle through the error codes. The current state of the error code is shown with the On/Off icon. To exit the maintenance sub-menu, press the BACK key to return to the M5 screen. Shown on this display is error code 1 with 4 occurrences. The current state is on. The error code display shows the error code number on the left, and the error code history on the right. User presses the ▲ or ▼ keys to cycle through the error codes. The current state of the error code is shown with the On/Off icon. To exit to the maintenance sub-menu, press the BACK key to return to the M5 screen. Shown on this display is error code 6 with 3 occurrences. The current state is off.

To Clear Error Codes' History:

Hold the ▲ or ▼ keys simultaneously for 3 seconds. See page 56 for alarm status and error codes.

M6 – Factory Use Only



UNIT OPERATION

There are two basic ways to operate the unit - Front Panel and Wallstat. The Front Panel and Wallstat are never active at the same time. Switching between these modes is controlled via the (FP) jumper on the Wallstat connector. When the jumper is ON, the mode = Front Panel.

Front Panel

System Mode Sequence (SCHEDULE = OFF)

There are two system modes of operation. One for a cool only unit (see figure 1) and one for a heat-cool unit (see figure 2). System parameters for each system mode are saved when exiting a system mode, and retrieved when entering a new system mode.

Figure 1

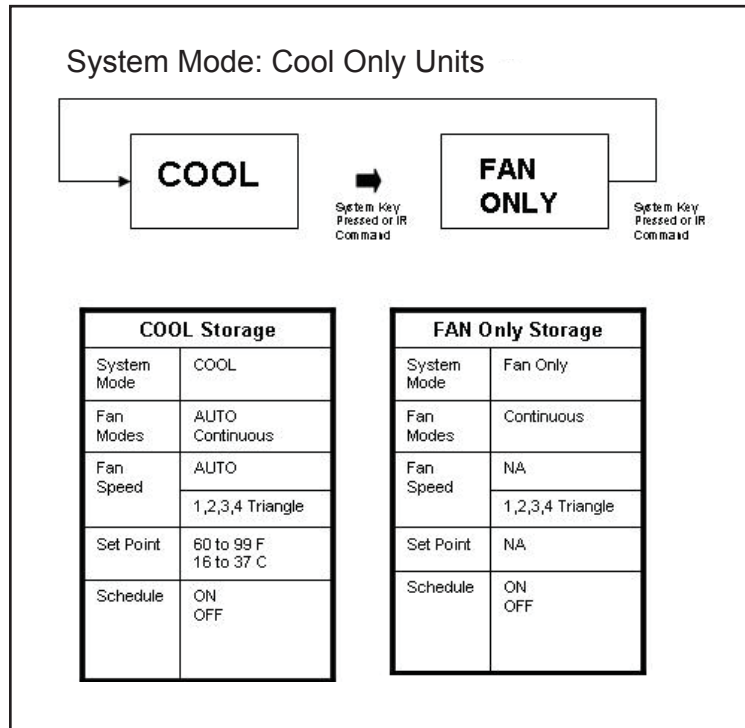
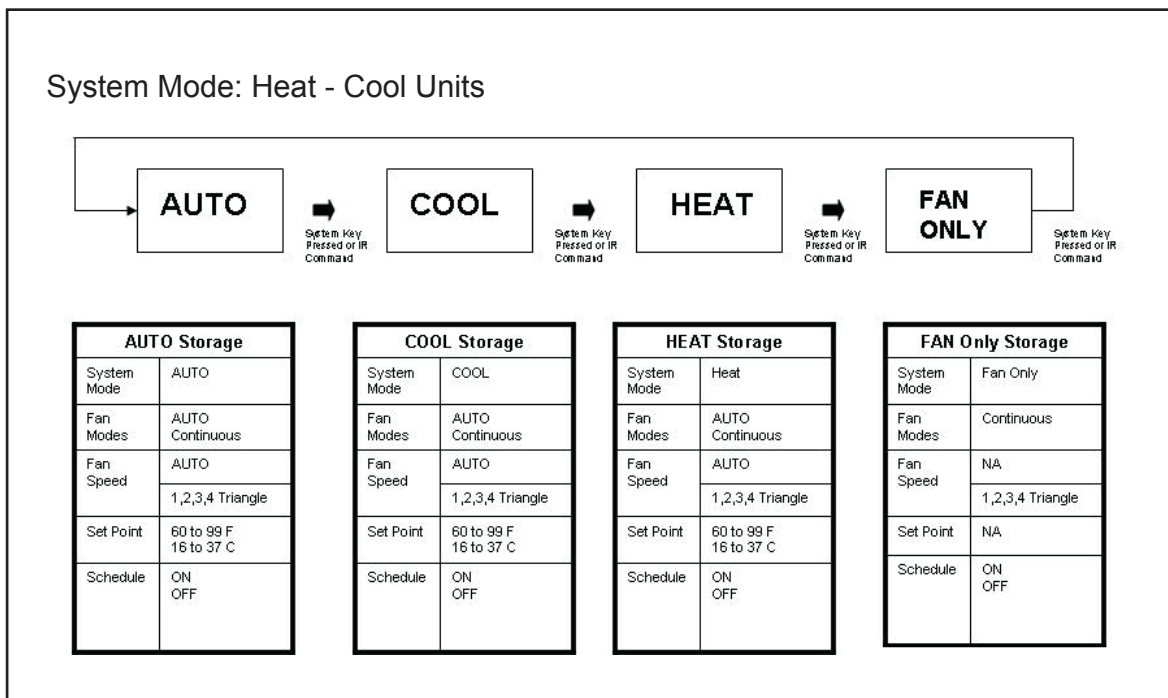

Figure 2



COOL-HEAT SET POINTS

The air conditioner control system is designed to control different product configurations with a select set of features. Some models just cool, some cool and heat with electric heat, and others cool and heat with a heat pump and/or electric heat.

The system set points are mapped to the internal controls as shown below.

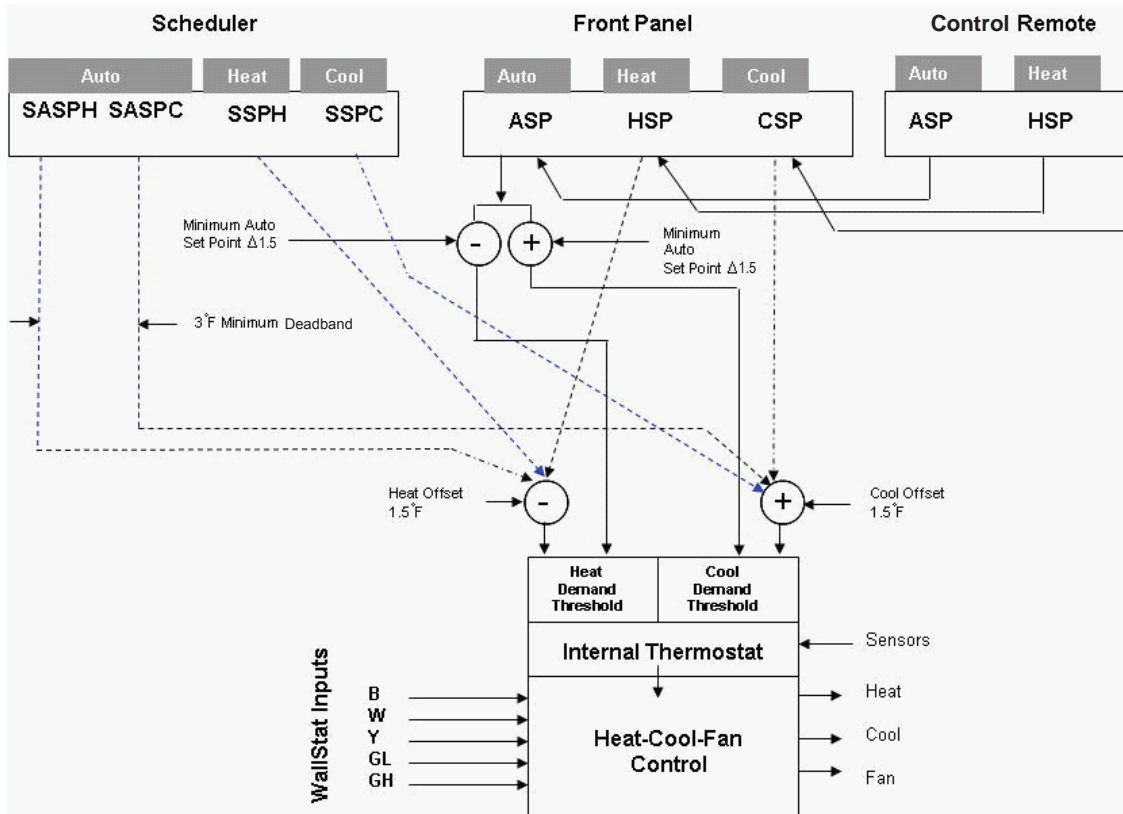

System Set Point Mapping Figure

There are 8 stored & variable set points in the system:

- 1 - ASPC: Auto Set Point Cool
- 2 - ASPH: Auto Set Point Heat
- 3 - CSP: Cool Only Set Point
- 4 - HSP: Heat Only Set Point
- 5 - SASPC: Scheduler Auto Set Point Cool
- 6 - SASPH: Scheduler Auto Set Point Heat
- 7 - SSPC: Scheduler Set Point Cool Only
- 8 - SSPH: Scheduler Set Point Heat Only

ELECTRONIC CONTROL SEQUENCE OF OPERATION

Compressor and Reversing Valve Control

Active Mode	Compressor	Reversing Valve State *
Cooling	On	De-Energized
Heat - Heat Pump	On	Energized
Heat - Electric	Off	*
Fan Only	Off	*

* The Reversing valve stays in the last state until a call for heat or cooling (see figure below)

Compressor Operation:

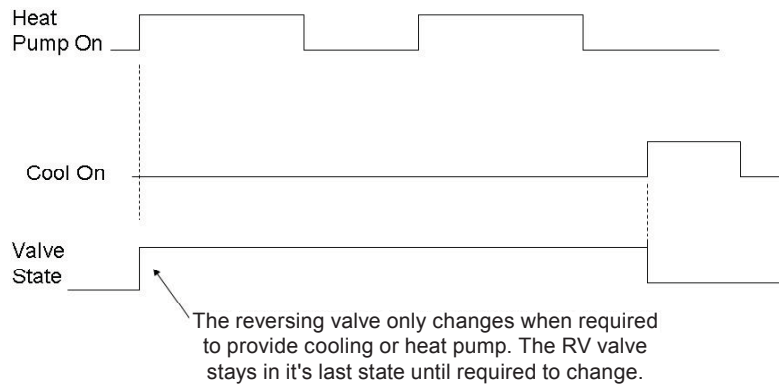

Reversing Valve Operation

Cooling Mode

Once the ambient temperature rises past the cool demand threshold (Cool Set Point + 1.5 °F) (see figure below), and the compressor is not locked out, the cooling cycle begins. As shown in the figure below, the fan is started 5 seconds prior to the compressor. Once the ambient temperature has been lowered to the cool set point (Cool Set Point minus .25 °F), the cooling cycle starts to terminate by shutting off the compressor. After a 30 seconds delay, the fan is shut off. (See figure below for graphic details)

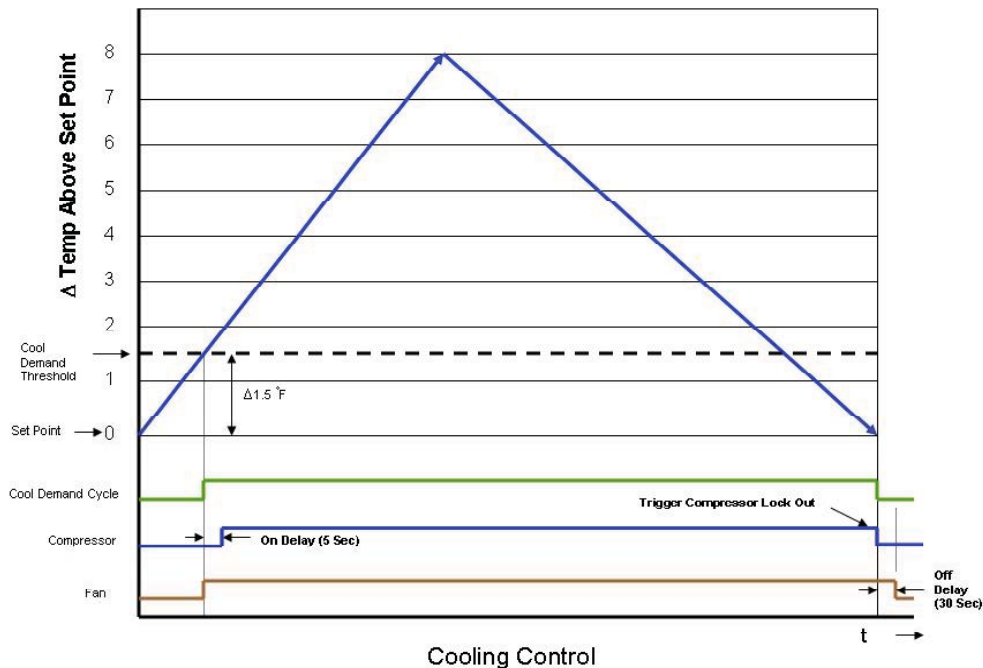

Heating Mode Control Operation

There are two heating methods: Heat Pump and Electric Resistance Heat.

There are 3 types of units that provide heating: Heat Pump Only (Model YS10M10)

Heat Pump with Electric Heat and Cool with Electric Heat.

Heat Control Operation Heat Pump Only

Once the ambient temperature falls below the Heating Demand Threshold

(1.5 °F Below the Heat Set Point Temperature), the heating cycle begins. The fan is turned on 5 seconds later. Once the ambient temperature has been raised to the Heat Satisfied Point (Set point + .25 °F), the compressor is turned off. The fan is turned off 30 seconds later. The figure below illustrates the basic heat pump operation.

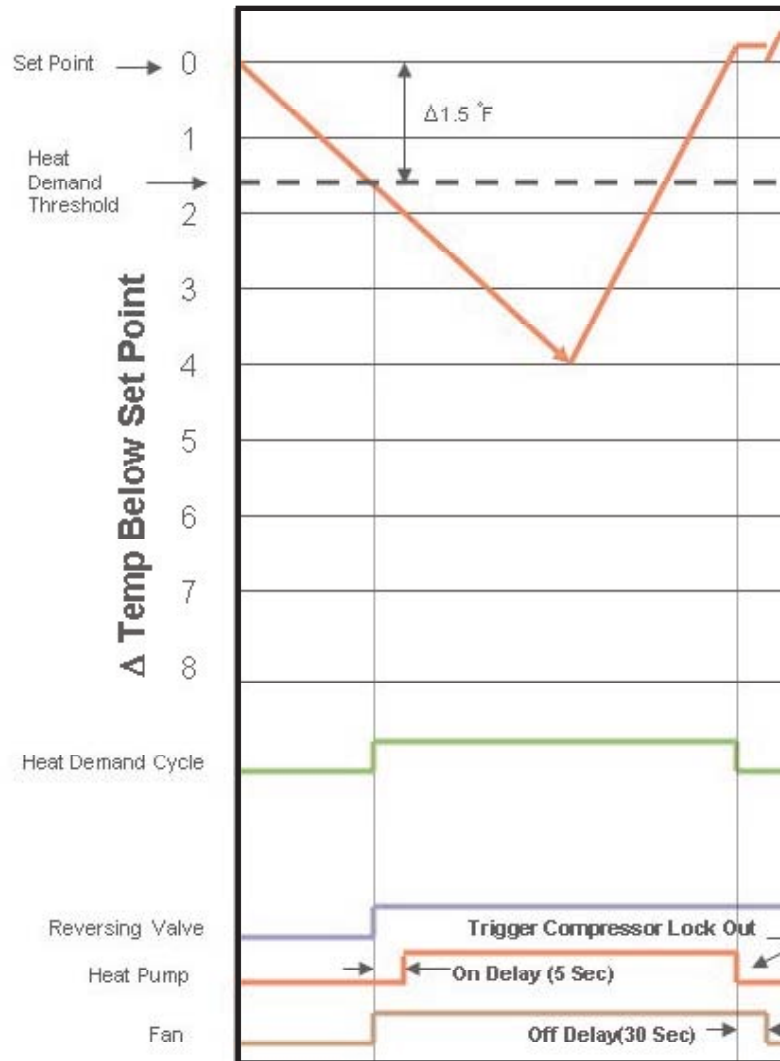

Heat Control (Heat Pump Only)

Heat Pump With Electric Heat Operation

This heating is more complex due to the possibility of two heating methods. If the ambient indoor temperature is below the heat demand threshold (1.5°F below the heat set point temperature), and the compressor is not locked out, turn on compressor. If the ambient indoor temperature is 0.25°F above the heat set point turn off the compressor.

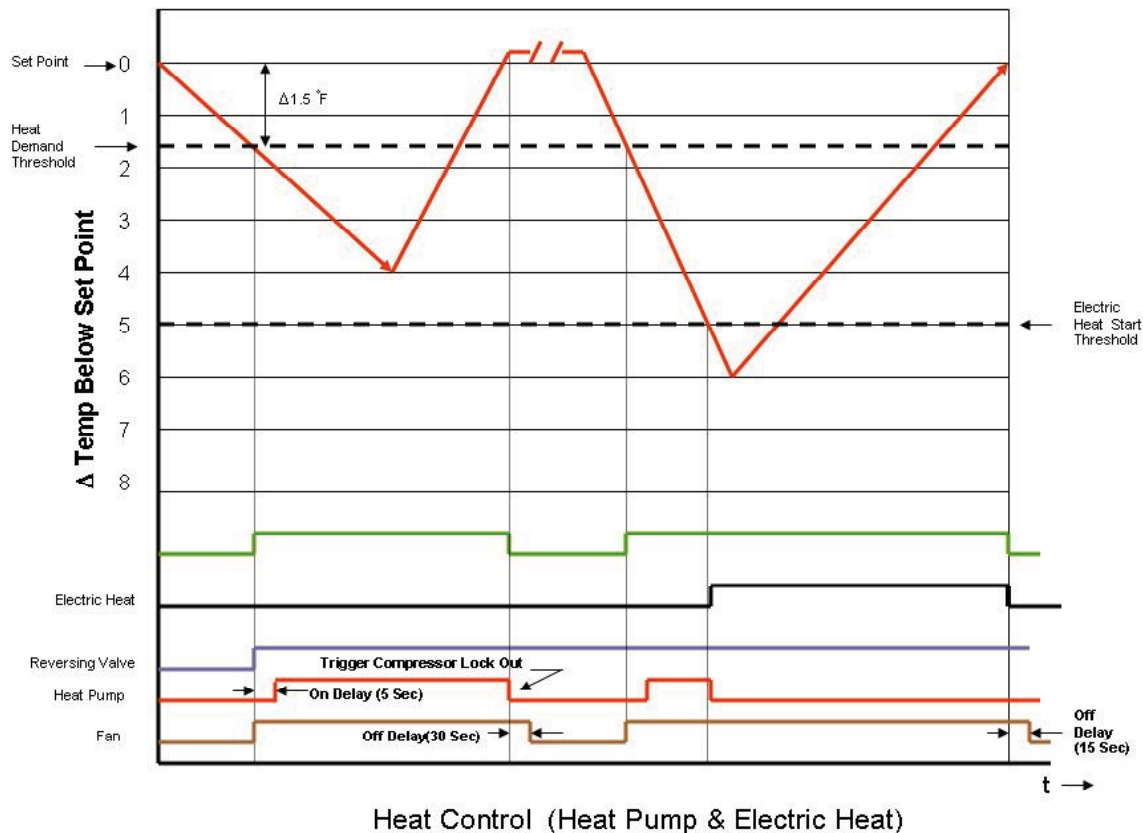

If the compressor is locked out & electric heat is available:

1. Turn on the electric heat until the compressor is not locked out.
2. After lockout, turn off the electric heat, wait 5 seconds, then turn on the compressor.

If Electric Heat is Available

After the Heat button is initially pressed, the unit will run the electric heater until the initial set point is satisfied (**Hot Start Feature**). After the initial start, the unit will switch to Heat Pump heat and decide between Heat Pump heat and Electric heat based on the following two monitored conditions:

Condition 1

If the outdoor coil temperature sensor drops to 30 °F or less for 2 consecutive minutes, the unit will switch to electric heat if available. Thereafter, the unit will switch back to Heat Pump heat if the outdoor coil temperature sensor rises to 45 °F or greater.

If Electric Heat is not available (out of order) and the outdoor coil temperature sensor drops to 30 °F or less for 2 consecutive minutes, then the compressor and fan will turn off. Thereafter, the unit will switch back to Heat Pump heat if the outdoor coil temperature rises to 45 °F or greater.

Heat Pump With Electric Heat Operation (Continued)

Condition 2

If the Δ (delta) (set point temperature minus the ambient indoor temperature) is greater than 5 °F, then the unit will switch to electric heat, if available. The unit will continue to operate with electric heat until the heat demand is satisfied. Note that the electric heat switches on after the Δ temp passes 5°F and the heat pump switches off. Also note that the electric heat will run until the heat demand is satisfied. When another heat demand cycle is initiated, the heat pump will run unless the Δ temp is greater than the electric heat threshold.

Emergency Heat

If a compressor fails in the heating season, the Emergency Heat allows the user to override the Heat Pump and heat with electric heat only. This is controlled via the user interface (See the User Menu Functions page 12).

Note that if heat is the first demand cycle (demand cycle = call for heat or call for cooling) after power restoration, the control system will run electric heat for the entire cycle if the unit is equipped with electric heat.

Electric Heat Operation in Cool with Electric Heat Units

When in the Heat mode, with and without Fan Mode Auto (Fan cycling):

If the indoor ambient temperature is below the Heat Demand Threshold (Heat Set Point minus 1.5 °F), turn on electric heat. If Ambient is 0.3 °F above the Heat Set Point turn off the electric heat.

System Mode Auto

This mode provides automatic change over between cool and heat. The auto mode runs based on the room ambient temperature vs. the Demand Thresholds. It is only available in Heat-Cool Unit.

Notes:

The Heat Demand Threshold and the Cool Demand Threshold values are derived from the Auto Set Point in the Auto Mode (refer to page 22). There is a buffer zone as shown in figure , where no heating or cooling is allowed to occur. It is critical that the Cool Demand Threshold be greater than the Heat Demand Threshold by a minimum of 3° while in the Auto System Mode. For example, if a user enters a value for the Auto Cooling Set Point that violates the minimum Δ 3° rule, the Auto Heating Set Point will adjust accordingly. This buffer zone (BAND) can be manually adjusted from 3 to 10° (see the BAND section page 13).

When programming the schedule, the user has the flexibility to enter the schedule automatic set point cooling (SASPC) and the schedule automatic set point heating (SSPH) set points directly. These values are monitored to ensure that they do not violate the minimum 3° Δ rule. If a violation is detected, the opposite set point will adjust to compensate. The individual heating and cooling rules apply to the auto mode.

Automatic Change Over Delay (Cool with Heat Units)

The change over delay ensures that any system heating or cooling over shoot does not trigger an opposite demand cycle. The change over delay = 15 min. This timer blocks the opposite demand cycle from running until the timer expires. As an example, if the last demand was a cool cycle, and another cool cycle is requested, the timer will not block the request. However, if the last demand cycle was a cool cycle, and heat cycle is requested, the timer will block the request until the change over delay is expired.

Compressor Lock Out Time

The lockout feature ensures that the compressor is de-energized for a period of time. The timer varies randomly from 180 to 240 seconds

The compressor lockout is initiated every time the compressor is “off” due to:

- (1) Satisfying the temperature set point
- (2) Changing mode to fan only or heat
- (3) Turning the unit off
- (4) Control is first plugged in or power is restored after failure
- (5) Line power is restored from a brown out condition

Wait ICON (Hour Glass)

The wait icon will be turned on when the compressor is locked out and during demand for cooling or heat pump compressor operation. The Wait ICON will be turned off when the condition clears.

Cooling Fan Delay

Fan cycle/Auto mode only

When unit cycles cooling ON – starts the fan 5 seconds EARLY. When unit cycles cooling OFF – DELAYS the fan off for 30 seconds

Note: this fan delay is disabled during Test Mode

Heating Fan Delay

This is only for fan Mode Auto (Fan cycles with cool/heat operation) and not for continuous fan mode. When unit cycles Heating ON – starts the fan 5 seconds EARLY. When unit cycles Heating OFF – DELAYS the fan off for 15 seconds

Note: the fan delay is disabled during Test Mode

Fan Speed Change Delay

Relay activation is delayed by a minimum number of seconds. The default for this value is 2 seconds and is used to eliminate relay chatter.

Fan Only System Mode

The fan is turned on and runs at the specified manually set speed.

Only the Fan is turned on. Cool or Heat operation are off.

(This is different than FAN MODE CONTINUOUS where the fan is on with the cool or heat operation).

Fan Only Rules

1. If the SYSTEM FAN ONLY MODE is selected, the Auto fan mode is disabled, and the fan mode is forced to continuous. In addition, the auto fan speed is disabled. If the user presses the fan speed key, the menu will skip over the auto selection. The set point temperature display is off.
2. Any fan speed may be manually selected during Fan Only Mode.

Fan Operation (Front Panel Mode)

Heat – Cool – Auto – Fan Only

Models starting with SS, SM have 4 speeds. Models with SL, and all Kuhl+ have 3 speeds

		Speed Selection				
		1	2	3	4	AUTO
Fan	Continuous	"On" "	On"	"On" "	On"	AUTO Operation, but never turns Off. Uses cool set point or heat set point vs. ambient temperature. When there is no demand, operate at the lowest available speed.
	AUTO	Turns On or Off with heat or cool demand	Turns On or Off with heat or cool demand	Turns On or Off with heat or cool demand	Turns On or Off with heat or cool demand	AUTO operation turns On or Off with heat or cool demand. Uses cool set point or heat set point vs. ambient temperature.
Mode	Fan Only	"On" "	On"	"On" "	On"	Disabled

Fan ICON Detail

The system may have a 3 or 4 speed fan. The Fan Speed ICON will Display as per the table below.

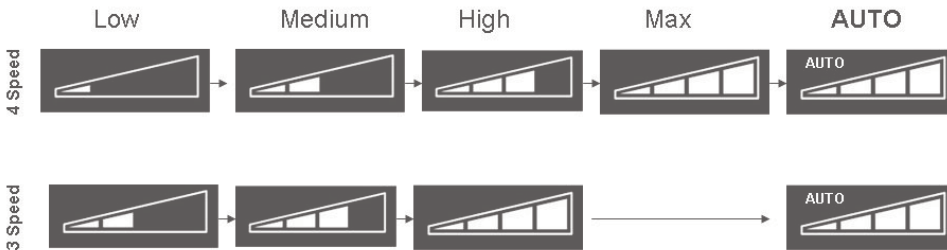

Note that in the AUTO mode, the speed of the fan will be shown by illuminating the number of bars in the speed triangle.

Fan Mapping

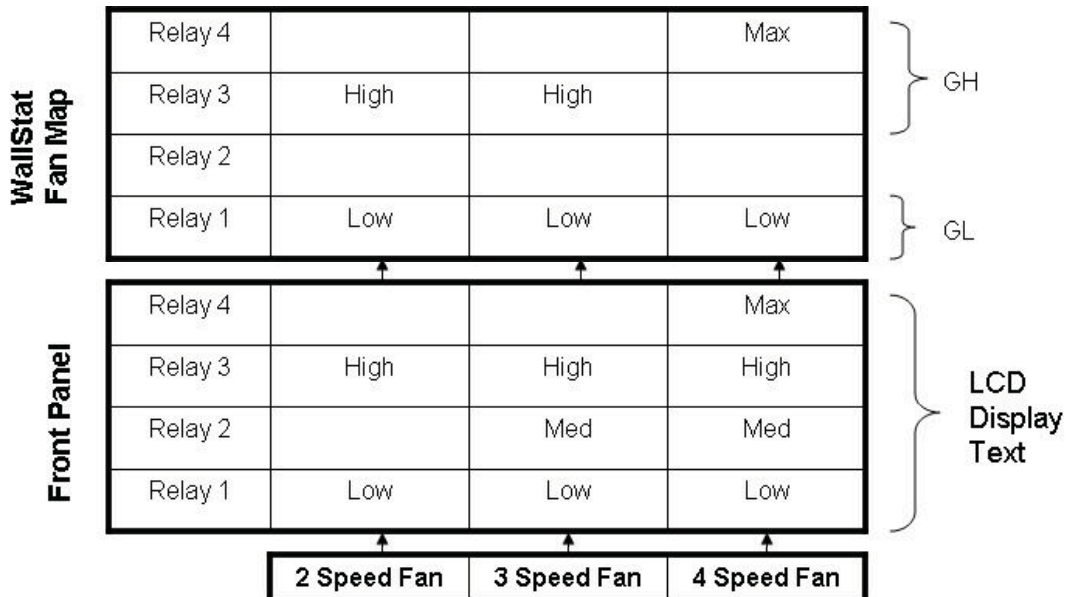

UNIT OPERATION WITH A WALL-STAT

Front Panel Display Operation in Wall-Stat Mode

The indoor ambient temperature sensor is disabled. All buttons are disabled with the following exception:

- A. Maintenance commands.
- B. The user menu for Freeze protection (Display/Enter button for Kuhl+ only units).
- C. First Button push to illuminate the back light (display will dim).

Maintenance features are operational. This includes the Check Filter, Lock Panel, M3, M4, M5, and the Service wrench icon. Under T-stat operation, as a default, the selected operating Mode (Cool, Heat or Fan) will not show on the front panel. The Service ICON (⊗) is displayed if a malfunction is detected.

Cool/Heat/Fan modes and Fan speed operations are controlled by the remote wall thermostat.

The fan speeds can be Low or Max for 4 speed units and Low or High for 3 speed units. (T-stat selected must have 2 speed capabilities)

Thermostat terminals requirements:

Must be single stage heat/cool.

For cooling only units: **C, R, G, Y.**

For cooling with electric heat units: **C, R, G, Y, W.**

For heat pump units: **C, R, G, Y, W, B.**

(See page 68 for RT5 T-Stat wiring diagrams)

During Heat Mode:

The B terminal must be continuously energized. The W terminal from the T-Stat must have 24 V AC output to call for heat. The control board decides on whether to turn on the Heat Pump Heat (compressor) or Electric Resistance Heat. The Y terminal should not have 24 VAC output during Heat Mode.

REMOVING THE FRONT COVER

⚠ WARNING



ELECTRIC SHOCK HAZARD

Disconnect power to the unit before servicing. Failure to follow this warning could result in serious injury or death.

Remove the decorative front cover by using the tool provided (see figure below).

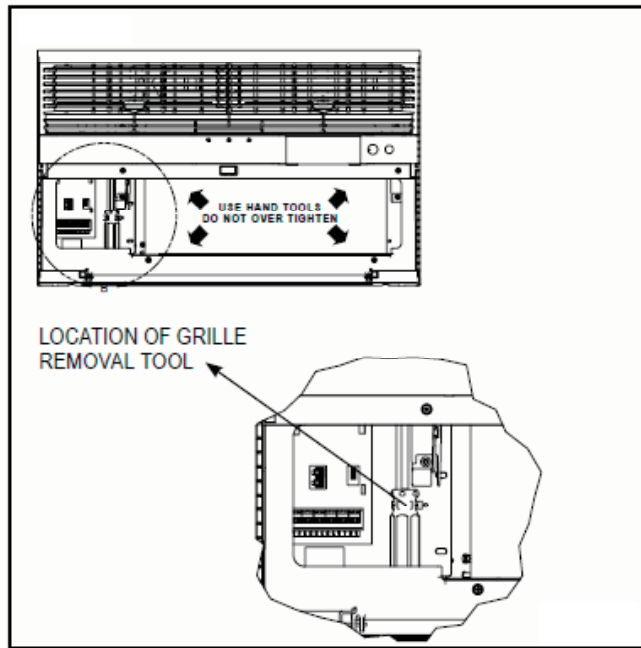

Tighten the four (4) captive screws as indicated by the arrows in the figure above before closing the front panel (**do not over tighten**). Ensure the filter is in place. Make sure curtains do not block the side air intake

Notes on reattaching the decorative front cover: Align the cord notch over the cord and center the fresh air lever. **Align the cover over the User Interface (UI) to ensure it is clear around it and it does not depress any buttons. If not installed correctly the wrench alert symbol could flash.**

REMOVING THE CHASSIS

⚠ WARNING



ELECTRIC SHOCK HAZARD

Disconnect power to the unit before servicing. Failure to follow this warning could result in serious injury or death.

Remove the decorative front cover. (See figure at left). Remove the chassis Entrygard Retainer Wire by removing the screw at the front right bottom corner screw (See Figure below). Save this screw for reattachment after reinstalling the chassis.

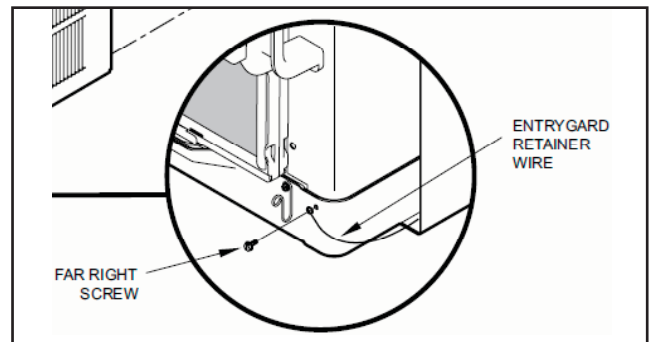

⚠ CAUTION

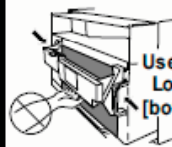

Handle Use

Use handle on both sides to pull unit from sleeve.

Do not push, pull or lift from center of support.

Hold the cabinet stationary then use the hand grips on both ends of the control unit support bracket to pull the chassis out of the cabinet (see below).

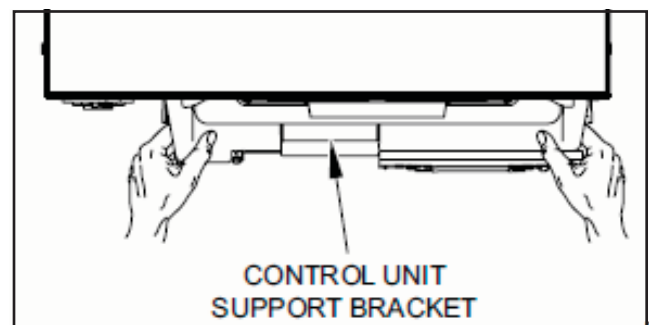

Before reinserting the chassis into the sleeve ensure to properly reinstall the chassis seal gasket.

REPLACING THE INDOOR COIL THERMISTOR

⚠ WARNING	
	ELECTRIC SHOCK HAZARD Disconnect power to the unit before servicing. Failure to follow this warning could result in serious injury or death.

Remove the decorative front cover (see page 30). Remove all indicated screws below (8 total, see figure below). Remove the Discharge Sensor and the User Interface plugs from the control board.



Remove the screws indicated at the side and back plate (6 total, see figure below). Partially lift the top cover and at the same time carefully swing out from the top, the back and side plate.

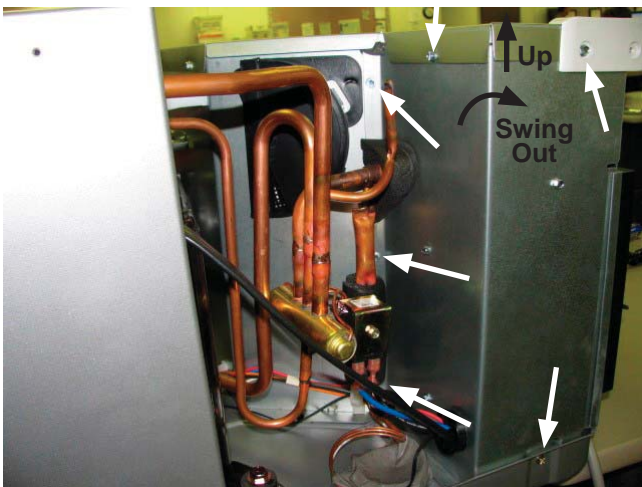

Replace the indoor coil sensor. Ensure to properly clip and insulate it at the same location (see figure below).

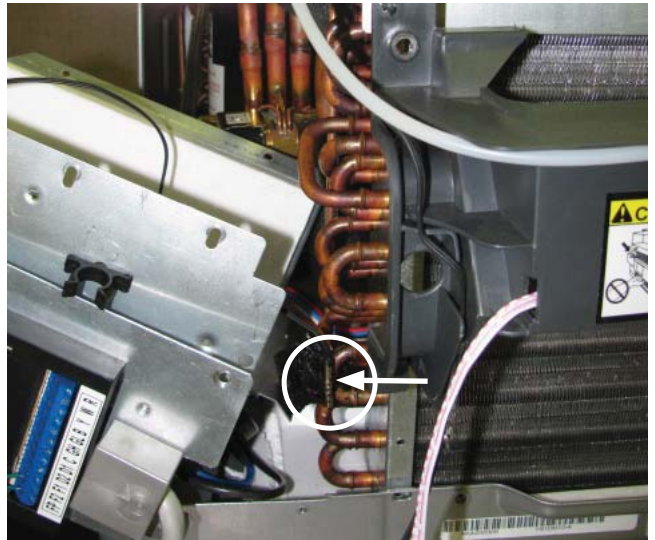

REPLACING THE CONTROL BOARD

⚠ WARNING	
	ELECTRIC SHOCK HAZARD Disconnect power to the unit before servicing. Failure to follow this warning could result in serious injury or death.

Remove the decorative front cover (see page 30). Disconnect discharge sensor plug (red) Disconnect the User Interface plug (white) Remove the 3 screws indicated below. Pull control board and mount plate out and disconnect the following connectors from it: Power, capacitor, thermistors, fan, reversing valve and heater. Remove the hex screw holding the control board to its mount plate. Pull out the control board (see figure below).

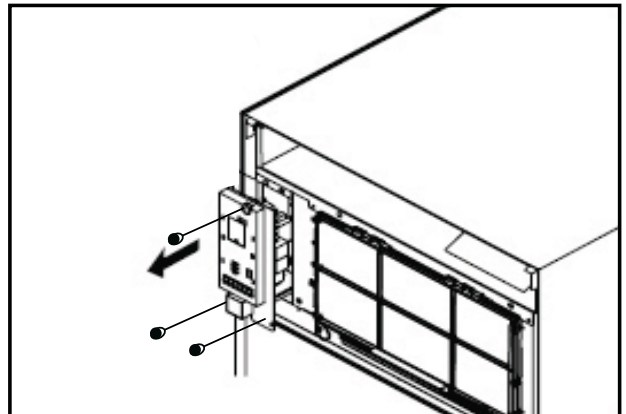

Low Voltage Interface Connector

⚠ WARNING

ELECTRIC SHOCK HAZARD

Disconnect power to the unit before servicing. Failure to follow this warning could result in serious injury or death.

All Kuhl and Kuhl + units have a low voltage interface connector through which a Remote Wall Thermostat, Desk Control and Auxiliary Fan's Relay can be connected. The interface connector is located on the left side behind the decorative front cover.

Interface Connector Location

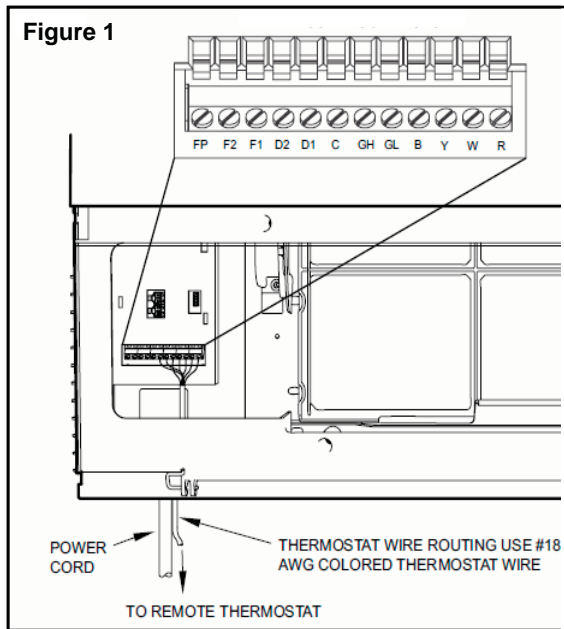

Table 1

Interface Connector Definitions	
FP	Front Panel. Wire jumper between FP and F2 enables front panel operation. Jumper off enables remote wall t-stat operation.
F2	Used with F1 to provide 24 VAC to external fan relay. (See above for use with FP)
F1	Used with F2 to provide 24 VAC to external fan relay.
D2	Used with D1 for desk control on or off operation.
D1	Used with D2 for desk control on or off operation.
C	Common Ground Terminal
GH	Call for high fan
GL	Call for low fan
B	Call for heat pump reversing valve
Y	Call for compressor
W	Call for heating
R	24V Power from Electronic Control to Wall

Adding a Remote Wall Thermostat

An external thermostat may be added to the air conditioner to provide remote temperature sensing and control.

Thermostat Selection

Friedrich recommends the use of either the Friedrich **RT4** or **RT5**. These thermostats are single stage heat/cool, manual changeover. The **RT4** is a digital display thermostat with single speed fan control. The **RT5** features a digital display, two fan speed selection, filter check light, temperature limiting, status indicator light, room temperature offset, backlight and battery backup. Other thermostats may be used as long as they are **single stage heat/cool** and are configured correctly for the unit.

Thermostat terminals requirements:

For cooling only units: **C, R, G, Y.**

For cooling with electric heat units: **C, R, G, Y, W.**

For heat pump units: **C, R, G, Y, W, B.**

For two fan speeds, thermostat must have 2 fan speed selection.

During Heat Pump Mode:

The B terminal must be continuously energized. The W terminal must have 24 VAC output to call for heat. The control board decides on whether to turn on the Heat Pump Heat (compressor) or Electric Heat. The Y terminal should not have 24 VAC output during heat mode.

Connecting a Remote Wall Thermostat

⚠ CAUTION

It is the installer's responsibility to ensure that all control wiring connections are made in accordance with the installation instructions.

Improper connection of the thermostat control wiring and/or tampering with the unit's internal wiring can void the equipment warranty.

Failure to follow these instructions can result in personal injury and damage to product or other property.

To enable the remote thermostat operation, remove the jumper between terminals FP & F2 on the interface connector. Connect the thermostat using Figure 1 and Table 1 as a guide.

Procedure

- 1) Unplug the unit.
- 2) Unscrew and remove the decorative front cover. (Page 30)
- 3) Locate the Interface Connector (24 VAC terminal strip (See figure 1 at left) and remove the jumper wire at FP and F2.
- 4) Make the wire connections according to the configuration needed for your unit (see above or page 68 for wiring diagrams).
- 5) Once each wire is matched and connected, the unit is now ready to be controlled by the thermostat.
- 6) Reattach the decorative front cover (see page 30).

Note: Under T-Stat operation the front panel is disabled

except the Maintenance functions (see page 29 for details).

Remote Wall Thermostat Location

The thermostat should not be mounted where it may be affected by drafts, discharge air from registers (hot or cold), or heat radiated from the sun appliances, windows etc.. The thermostat should be located about 5 Ft. above the floor in an area of average temperature, with good air circulation.

Mercury bulb type thermostats MUST be level to control temperature accurately to the desired set-point. Electronic digital type thermostats should be level for aesthetics.

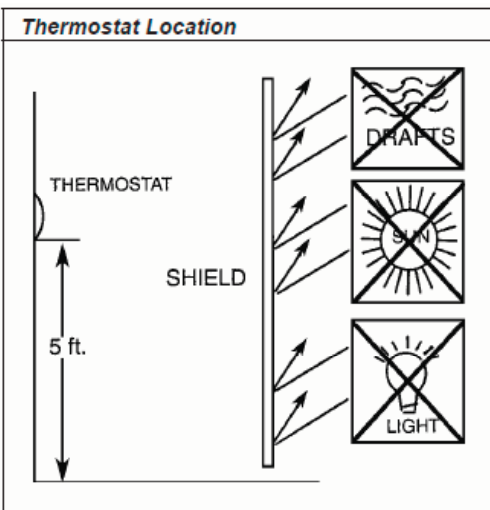

Note: An improperly operating or poorly located remote wall thermostat can be the source of perceived equipment problems. A careful check of the thermostat's location and wiring must be made then to ensure that it is not the source of problems.

Desk Control

The unit's electronic control has built-in provisions for connection to an external switch to control power to the unit. The switch can be a central desk control system or even a normally open door switch.

For desk control operation, connect one side of the switch to the D1 terminal and the other to the D2 terminal (See page 32). Whenever the switch closes, the unit operation will stop.

Maximum Wire Length for Desk Control Switch

Wire Size	Maximum Length
#24	400 ft.
#22	600 ft.
#20	900 ft.
#18	1500 ft.
#16	2000 ft.

Auxiliary Fan Control

The electronic control also has the ability to control a 24 VAC relay to activate an auxiliary, or transfer fan. The outputs are listed as F1 and F2 on the interface connector (See page 32).

To connect the relay, simply wire one side of the relay to F1 and the other side to F2. Anytime that the fan runs, the terminals will send a 24 VAC signal to the relay. The relay must be 24 VAC, 50mA or less.

Note: The Desk Control, Auxiliary Fan relay and wires must be field supplied.

Airflow Selection and Adjustment

Air flow direction adjustment

The airflow path may be adjusted to distribute air independently from the left or right side of the discharge opening. Each of the banks of louvers can be directed left, right, up or down in order to achieve the most optimum airflow positioning.

To adjust airflow direction grab the lever in the center of the louver bank and move it in the direction that you would like the air to be directed. Please note that it is normal that airflow may be stronger out of one side of the louvers than the other.

Fresh air and exhaust control

Your air conditioner has the ability to bring fresh air into the room or exhaust stale air out of the room. The control slide is found on the upper part of the unit (See Figure).

TO BRING IN FRESH AIR – Move the lever to the *Fresh Air*  position which allows outside air to enter the room. This is useful in fall and spring as a means of bringing in fresh outside air when using FAN ONLY . It can also be used in the summer with the compressor in the Cooling Mode if you wish.

TO EXHAUST INDOOR AIR – Move the lever to the *Exhaust*  position. This will allow stale air to be expelled to the outside of the dwelling. This is especially handy in the spring or fall when indoor air tends to get stale, or after a social gathering involving smokers, or to remove cooking odors.

BEST PERFORMANCE – Move the lever to the *Re-Circulate Position* . This is the most efficient mode for cooling and heating.

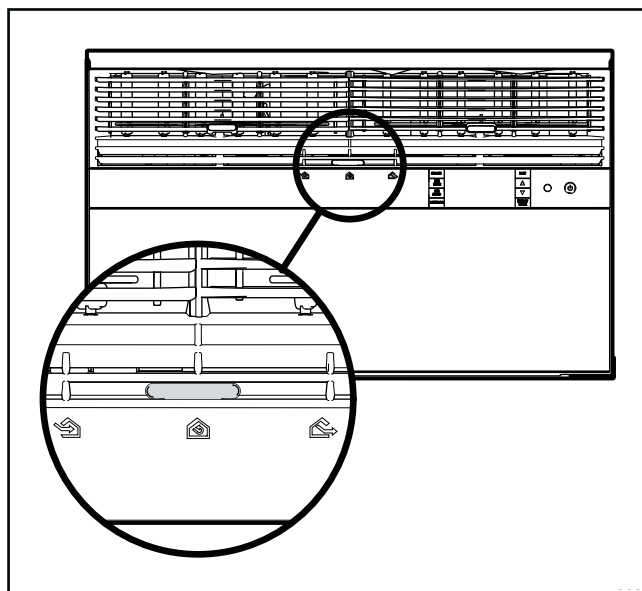

COMPONENTS TESTING

FAN MOTOR

A single phase permanent split capacitor motor is used to drive the evaporator blower and condenser fan. A self-resetting overload is located inside the motor to protect against high temperature and high amperage conditions. (See Figure 23)

⚠ WARNING	
	ELECTRIC SHOCK HAZARD Disconnect power to the unit before servicing. Failure to follow this warning could result in serious injury or death.

BLOWER/FAN MOTOR - TEST

1. Determine that capacitor is serviceable.
2. Disconnect fan motor wires from fan speed switch or system switch.
3. Apply "live" test cord probes on black wire and common terminal of capacitor. Motor should run at high speed.
4. Apply "live" test cord probes on red wire and common terminal of capacitor. Motor should run at low speed.
5. Apply "live" test cord probes on each of the remaining wires from the speed switch or system switch to test intermediate speeds. If the control is in the "MoneySaver" mode and the thermostat calls for cooling, the fan will start - then stop after approximately 2 minutes; then the fan and compressor will start together approximately 2 minutes later.

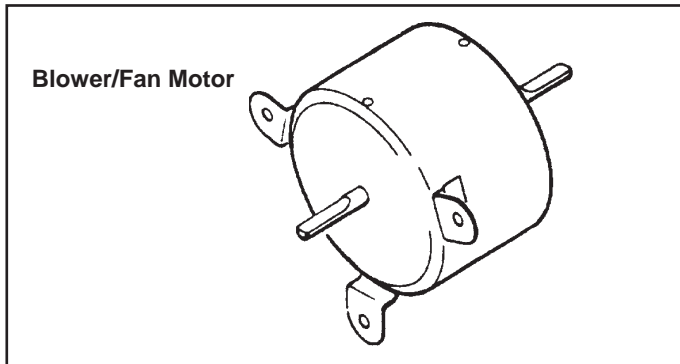

CAPACITORS

⚠ WARNING	
	ELECTRIC SHOCK HAZARD Turn off electric power before servicing. Discharge capacitor with a 20,000 Ohm 2 Watt resistor before handling. Failure to do so may result in personal injury, or death.

Many motor capacitors are internally fused. Shorting the terminals will blow the fuse, ruining the capacitor. A 20,000 ohm 2 watt resistor can be used to discharge capacitors safely. Remove wires from capacitor and place resistor across terminals. When checking a dual capacitor with a capacitor analyzer or ohmmeter, both sides must be tested.

Capacitor Check with Capacitor Analyzer

The capacitor analyzer will show whether the capacitor is "open" or "shorted." It will tell whether the capacitor is within its micro farads rating and it will show whether the capacitor is operating at the proper power-factor percentage. The instrument will automatically discharge the capacitor when the test switch is released.

Capacitor Connections

The starting winding of a motor can be damaged by a shorted and grounded running capacitor. This damage usually can be avoided by proper connection of the running capacitor terminals.

From the supply line on a typical 230 volt circuit, a 115 volt potential exists from the "R" terminal to ground through a possible short in the capacitor. However, from the "S" or start terminal, a much higher potential, possibly as high as 400 volts, exists because of the counter EMF generated in the start winding. Therefore, the possibility of capacitor failure is much greater when the identified terminal is connected to the "S" or start terminal. The identified terminal should always be connected to the supply line, or "R" terminal, never to the "S" terminal.

When connected properly, a shorted or grounded running capacitor will result in a direct short to ground from the "R" terminal and will blow the line fuse. The motor protector will protect the main winding from excessive temperature.

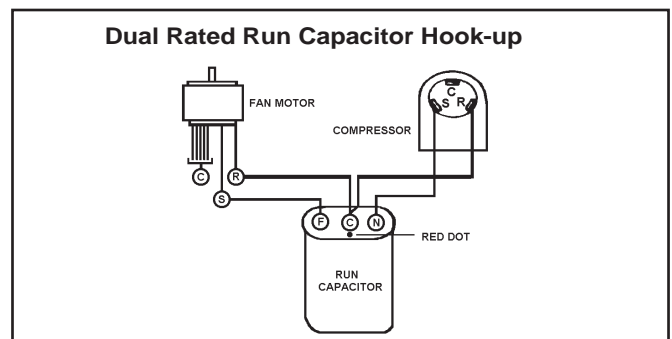

COMPONENTS TESTING

HEATING ELEMENT

All heat pumps and electric heat models are equipped with a heating element with the exception of model YS10M10. The other "YS" and "ES" models are equipped with a 3.3 KW element. The "YM" and "EM" models are equipped with a 4.0 KW element. The "YL" and "EL" models are equipped with a 5.2 KW element.

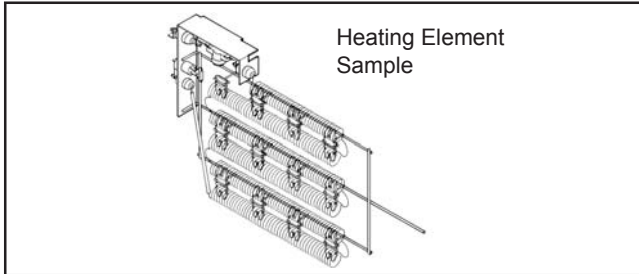

The heating element contains a fuse link and a heater limit switch. The fuse link is in series with the power supply and will open and interrupt the power when the temperature reaches 199°F or a short circuit occurs in the heating element. Once the fuse link separates, a new fuse link must be installed.

NOTE: Always replace with the exact replacement.

The heater element has a high limit control. This control is a bimetal thermostat mounted in the top of the heating element.

Should the fan motor fail or filter become clogged, the high limit control will open and interrupt power to the heater before reaching an unsafe temperature condition.

The control is designed to open at 110°F ±6°F. Test continuity below 110°F and for open above 110°F.

HEATING ELEMENT (Heat Pump Models)

The heating element for the "Y" model is energized by an outdoor thermistor via the electronic control board. The outdoor defrost thermistor is adjusted at a predetermined temperature to bring on the heating element and turn off the compressor. The room

TESTING THE HEATING ELEMENT

⚠ WARNING	
	ELECTRIC SHOCK HAZARD Disconnect power to the unit before servicing. Failure to follow this warning could result in serious injury or death.

Testing of the elements can be made with an ohmmeter across the terminals after the connecting wires have been removed. A cold resistance reading of approximately 14.5 ohms for the 3.3 KW heater, 11.9 ohms for the 4.0 KW heater and 9.15 ohms for the 5.2 KW heater should be registered.

DRAIN PAN VALVE

During the cooling mode of operation, condensate which collects in the drain pan is picked up by the condenser fan blade and sprayed onto the condenser coil. This assists in cooling the refrigerant plus evaporating the water.

During the heating mode of operation, it is necessary that water be removed to prevent it from freezing during cold outside temperatures. This could cause the condenser fan blade to freeze in the accumulated water and prevent it from turning.

To provide a means of draining this water, a bellows type drain valve is installed over a drain opening in the base pan.

This valve is temperature sensitive and will open when the outside temperature reaches 40°F. The valve will close gradually as the temperature rises above 40°F to fully close at 60°F.

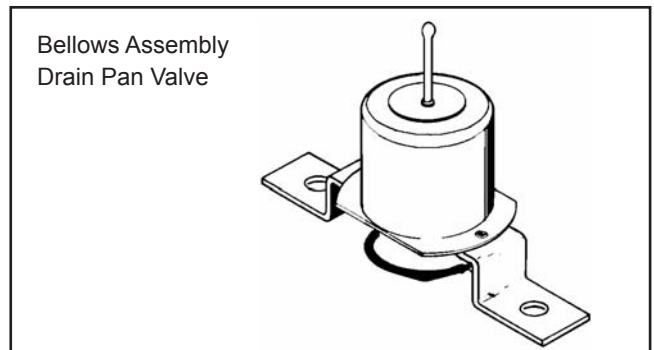

REFRIGERATION SEQUENCE OF OPERATION

A good understanding of the basic operation of the refrigeration system is essential for the service technician. Without this understanding, accurate troubleshooting of refrigeration system problems will be more difficult and time consuming, if not (in some cases) entirely impossible. The refrigeration system uses four basic principles (laws) in its operation they are as follows:

1. "Heat always flows from a warmer body to a cooler body."
2. "Heat must be added to or removed from a substance before a change in state can occur"
3. "Flow is always from a higher pressure area to a lower pressure area."
4. "The temperature at which a liquid or gas changes state is dependent upon the pressure."

The refrigeration cycle begins at the compressor. Starting the compressor creates a low pressure in the suction line which draws refrigerant gas (vapor) into the compressor. The compressor then "compresses" this refrigerant, raising its pressure and its (heat intensity) temperature.

The refrigerant leaves the compressor through the discharge Line as a hot High pressure gas (vapor). The refrigerant enters the condenser coil where it gives up some of its heat. The condenser fan moving air across the coil's finned surface facilitates the transfer of heat from the refrigerant to the relatively cooler outdoor air.

When a sufficient quantity of heat has been removed from the refrigerant gas (vapor), the refrigerant will "condense" (i.e. change to a liquid). Once the refrigerant has been condensed (changed) to a liquid it is cooled even further by the air that continues to flow across the condenser coil.

The RAC design determines at exactly what point (in the condenser) the change of state (i.e. gas to a liquid) takes place. In all cases, however, the refrigerant must be totally condensed (changed) to a Liquid before leaving the condenser coil.

The refrigerant leaves the condenser Coil through the liquid line as a warm high pressure liquid. It next will pass through the refrigerant drier (if so equipped). It is the function of the drier to trap any moisture present in the system, contaminants, and large particulate matter.

The liquid refrigerant next enters the metering device. The metering device is a capillary tube. The purpose of the metering device is to "meter" (i.e. control or measure) the quantity of refrigerant entering the evaporator coil.

In the case of the capillary tube this is accomplished (by design) through size (and length) of device, and the pressure difference present across the device.

Since the evaporator coil is under a lower pressure (due to the suction created by the compressor) than the liquid line, the liquid refrigerant leaves the metering device entering the evaporator coil. As it enters the evaporator coil, the larger area and lower pressure allows the refrigerant to expand and lower its temperature (heat intensity). This expansion is often referred to as "boiling". Since the unit's blower is moving indoor air across the finned surface of the evaporator coil, the expanding refrigerant absorbs some of that heat. This results in a lowering of the indoor air temperature, hence the "cooling" effect.



The expansion and absorbing of heat cause the liquid refrigerant to evaporate (i.e. change to a gas). Once the refrigerant has been evaporated (changed to a gas), it is heated even further by the air that continues to flow across the evaporator coil.

The particular system design determines at exactly what point (in the evaporator) the change of state (i.e. liquid to a gas) takes place. In all cases, however, the refrigerant must be totally evaporated (changed) to a gas before leaving the evaporator coil.

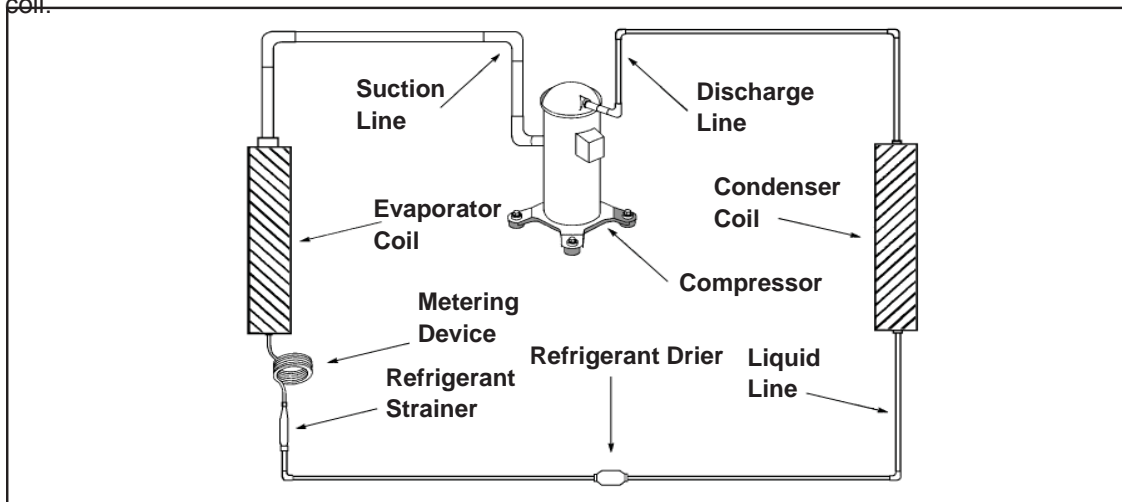
The low pressure (suction) created by the compressor causes the refrigerant to leave the evaporator through the suction line as a cool low pressure vapor. The refrigerant then returns to the compressor, where the cycle is repeated.



R-410A SEALED SYSTEM REPAIR CONSIDERATIONS

 WARNING	
	<p>Refrigeration system under high pressure</p> <p>Do not puncture, heat, expose to flame or incinerate.</p> <p>Only certified refrigeration technicians should service this equipment.</p> <p>R410A systems operate at higher pressures than R22 equipment. Appropriate safe service and handling practices must be used.</p> <p>Only use gauge sets designed for use with R410A. Do not use standard R22 gauge sets.</p>

The following is a list of important considerations when working with R-410A equipment

- R-410A pressure is approximately 60% higher than R-22 pressure.
- R-410A cylinders must not be allowed to exceed 125 F, they may leak or rupture.
- R-410A must never be pressurized with a mixture of air, it may become flammable.
- Servicing equipment and components must be specifically designed for use with R-410A and dedicated to prevent contamination.
- Manifold sets must be equipped with gauges capable of reading 750 psig (high side) and 200 psig (low side), with a 500-psig low-side retard.
- Gauge hoses must have a minimum 750-psig service pressure rating
- Recovery cylinders must have a minimum service pressure rating of 400 psig, (DOT 4BA400 and DOT BW400 approved cylinders).
- POE (Polyol-Ester) lubricants must be used with R-410A equipment.
- To prevent moisture absorption and lubricant contamination, do not leave the refrigeration system open to the atmosphere longer than 1 hour.
- Weigh-in the refrigerant charge into the high side of the system.
- Introduce liquid refrigerant charge into the high side of the system.
- For low side pressure charging of R-410A, use a charging adaptor.
- Use Friedrich approved R-410A filter dryers only.

R-410A SEALED REFRIGERATION SYSTEM REPAIRS

IMPORTANT

SEALED SYSTEM REPAIRS TO COOL-ONLY MODELS REQUIRE THE INSTALLATION OF A LIQUID LINE DRIER.

EQUIPMENT REQUIRED:

1. Voltmeter
2. Ammeter
3. Ohmmeter
4. E.P.A. Approved Refrigerant Recovery System
5. Vacuum Pump (capable of 200 microns or less vacuum.)
6. Acetylene Welder
7. Electronic Halogen Leak Detector capable of detecting HFC (Hydrofluorocarbon) refrigerants.
8. Accurate refrigerant charge measuring device such as:
 - a. Balance Scales - 1/2 oz. accuracy
 - b. Charging Board - 1/2 oz. accuracy
9. High Pressure Gauge - (0 to 750 lbs.)
10. Low Pressure Gauge - (-30 to 200 lbs.)
11. Vacuum Gauge - (0 - 1000 microns)
12. Facilities for flowing nitrogen through refrigeration tubing during all brazing processes.

EQUIPMENT MUST BE CAPABLE OF:

1. Recovering refrigerant to EPA required levels.
2. Evacuation from both the high side and low side of the system simultaneously.
3. Introducing refrigerant charge into high side of the system.
4. Accurately weighing the refrigerant charge introduced into the system.

WARNING



RISK OF ELECTRIC SHOCK

Unplug and/or disconnect all electrical power to the unit before performing inspections, maintenances or service.

Failure to do so could result in electric shock, serious injury or death.

WARNING



HIGH PRESSURE HAZARD

Sealed Refrigeration System contains refrigerant and oil under high pressure.

Proper safety procedures must be followed, and proper protective clothing must be worn when working with refrigerants.

Failure to follow these procedures could result in serious injury or death.

Proper refrigerant charge is essential to proper unit operation. Operating a unit with an improper refrigerant charge will result in reduced performance (capacity) and/or efficiency. Accordingly, the use of proper charging methods during servicing will insure that the unit is functioning as designed and that its compressor will not be damaged.

Too much refrigerant (overcharge) in the system is just as bad (if not worse) than not enough refrigerant (undercharge). They both can be the source of certain compressor failures if they remain uncorrected for any period of time. Quite often, other problems (such as low air flow across evaporator, etc.) are misdiagnosed as refrigerant charge problems. The refrigerant circuit diagnosis chart will assist you in properly diagnosing these systems.

An overcharged unit will at times return liquid refrigerant (slugging) back to the suction side of the compressor eventually causing a mechanical failure within the compressor. This mechanical failure can manifest itself as valve failure, bearing failure, and/or other mechanical failure. The specific type of failure will be influenced by the amount of liquid being returned, and the length of time the slugging continues.

Not enough refrigerant (undercharge) on the other hand, will cause the temperature of the suction gas to increase to the point where it does not provide sufficient cooling for the compressor motor. When this occurs, the motor winding temperature will increase causing the motor to overheat and possibly cycle open the compressor overload protector. Continued overheating of the motor windings and/or cycling of the overload will eventually lead to compressor motor or overload failure.

Refrigerant Charging

NOTE: Because the RAC system is a sealed system, service process tubes will have to be installed. First install a line tap and remove refrigerant from system. Make necessary sealed system repairs and vacuum system. Crimp process tube line and solder end shut. Do not leave a service valve in the sealed system.

Method Of Charging / Repairs

The acceptable method for charging the WallMaster system is the Weighed in Charge Method. The weighed in charge method is applicable to all units. It is the preferred method to use, as it is the most accurate.

The weighed in method should always be used whenever a charge is removed from a unit such as for a leak repair, compressor replacement, or when there is no refrigerant charge left in the unit. To charge by this method, requires the following steps:

1. Install a piercing valve to remove refrigerant from the sealed system. (Piercing valve must be removed from the system before recharging.)
2. Recover Refrigerant in accordance with EPA regulations.

⚠ WARNING	
	BURN HAZARD Proper safety procedures must be followed, and proper protective clothing must be worn when working with a torch. Failure to follow these procedures could result in moderate or serious injury.

3. Install a process tube to sealed system.

⚠ CAUTION	
	FREEZE HAZARD Proper safety procedures must be followed, and proper protective clothing must be worn when working with liquid refrigerant. Failure to follow these procedures could result in minor to moderate injury.

4. Make necessary repairs to system.
5. Evacuate system to 200 microns or less.
6. Weigh in refrigerant with the property quantity of R-410A refrigerant.
7. Start unit, and verify performance.

⚠ WARNING	
	BURN HAZARD Proper safety procedures must be followed, and proper protective clothing must be worn when working with a torch. Failure to follow these procedures could result in moderate or serious injury.

8. Crimp the process tube and solder the end shut.

⚠ WARNING



ELECTRIC SHOCK HAZARD

Turn off electric power before service or installation.

Extreme care must be used, if it becomes necessary to work on equipment with power applied.

Failure to do so could result in serious injury or death.

⚠ WARNING



HIGH PRESSURE HAZARD

Sealed Refrigeration System contains refrigerant and oil under high pressure.

Proper safety procedures must be followed, and proper protective clothing must be worn when working with refrigerants.

Failure to follow these procedures could result in serious injury or death.

Undercharged Refrigerant Systems

An undercharged system will result in poor performance (low pressures, etc.) in both the heating and cooling cycle.

Whenever you service a unit with an undercharge of refrigerant, always suspect a leak. The leak must be repaired before charging the unit.

To check for an undercharged system, turn the unit on, allow the compressor to run long enough to establish working pressures in the system (15 to 20 minutes).

During the cooling cycle you can listen carefully at the exit of the metering device into the evaporator; an intermittent hissing and gurgling sound indicates a low refrigerant charge. Intermittent frosting and thawing of the evaporator is another indication of a low charge, however, frosting and thawing can also be caused by insufficient air over the evaporator.

Checks for an undercharged system can be made at the compressor. If the compressor seems quieter than normal, it is an indication of a low refrigerant charge.

A check of the amperage drawn by the compressor motor should show a lower reading. (Check the Unit Specification.) After the unit has run 10 to 15 minutes, check the gauge pressures. Gauges connected to system with an undercharge will have low head pressures and substantially low suction pressures.

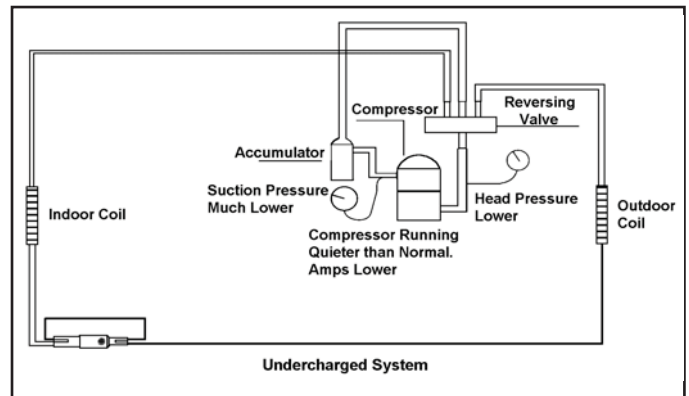

Overcharged Refrigerant Systems

Compressor amps will be near normal or higher. Noncondensables can also cause these symptoms. To confirm, remove some of the charge, if conditions improve, system may be overcharged. If conditions don't improve, Noncondensables are indicated.

Whenever an overcharged system is indicated, always make sure that the problem is not caused by air flow problems. Improper air flow over the evaporator coil may indicate some of the same symptoms as an over charged system.

An overcharge can cause the compressor to fail, since it would be "slugged" with liquid refrigerant.

The charge for any system is critical. When the compressor is noisy, suspect an overcharge, when you are sure that the air quantity over the evaporator coil is correct. Icing

of the evaporator will not be encountered because the refrigerant will boil later if at all. Gauges connected to system will usually have higher head pressure (depending upon amount of over charge). Suction pressure should be slightly higher.

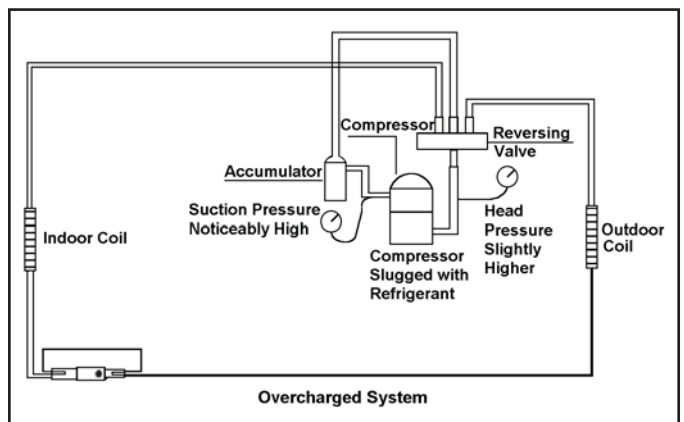

Restricted Refrigerant System

Troubleshooting a restricted refrigerant system can be difficult. The following procedures are the more common problems and solutions to these problems. There are two types of refrigerant restrictions: Partial restrictions and complete restrictions.

A partial restriction allows some of the refrigerant to circulate through the system.

With a complete restriction there is no circulation of refrigerant in the system.

Restricted refrigerant systems display the same symptoms as a "low-charge condition."

When the unit is shut off, the gauges may equalize very slowly.

Gauges connected to a completely restricted system will run in a deep vacuum. When the unit is shut off, the gauges will not equalize at all.

A quick check for either condition begins at the evaporator. With a partial restriction, there may be gurgling sounds

at the metering device entrance to the evaporator. The evaporator in a partial restriction could be partially frosted or have an ice ball close to the entrance of the metering device. Frost may continue on the suction line back to the compressor.

Often a partial restriction of any type can be found by feel, as there is a temperature difference from one side of the restriction to the other.

With a complete restriction, there will be no sound at the metering device entrance. An amperage check of the compressor with a partial restriction may show normal current when compared to the unit specification. With a complete restriction the current drawn may be considerably less than normal, as the compressor is running in a deep vacuum (no load.) Much of the area of the condenser will be relatively cool since most or all of the liquid refrigerant will be stored there.

The following conditions are based primarily on a system in the cooling mode.

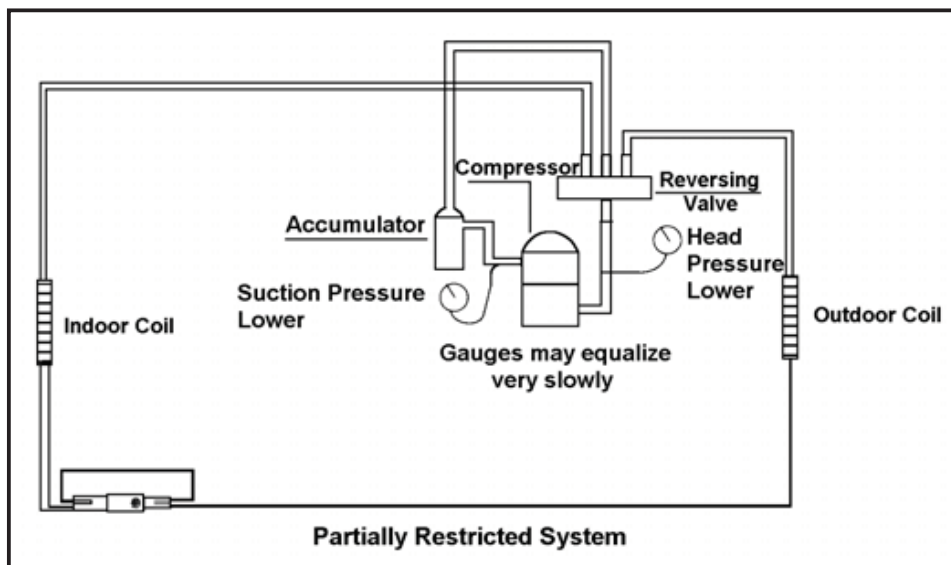
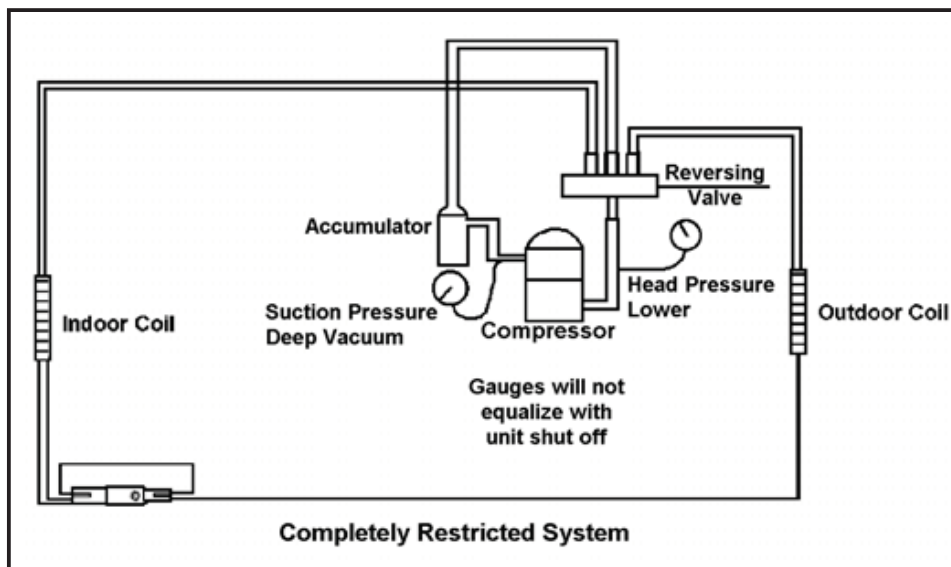

HERMETIC COMPONENTS CHECK

⚠ WARNING	
	BURN HAZARD Proper safety procedures must be followed, and proper protective clothing must be worn when working with a torch. Failure to follow these procedures could result in moderate or serious injury.

⚠ WARNING	
	CUT/SEVER HAZARD Be careful with the sharp edges and corners. Wear protective clothing and gloves, etc. Failure to do so could result in serious injury.

METERING DEVICE

Capillary Tube Systems

All units are equipped with capillary tube metering devices.

Checking for restricted capillary tubes.

1. Connect pressure gauges to unit.
2. Start the unit in the cooling mode. If after a few minutes of operation the pressures are normal, the check valve and the cooling capillary are not restricted.

3. Switch the unit to the heating mode and observe the gauge readings after a few minutes running time. If the system pressure is lower than normal, the heating capillary is restricted.
4. If the operating pressures are lower than normal in both the heating and cooling mode, the cooling capillary is restricted.

CHECK VALVE

A unique two-way check valve is used on the reverse cycle heat pumps. It is pressure operated and used to direct the flow of refrigerant through a single filter drier and to the proper capillary tube during either the heating or cooling cycle.

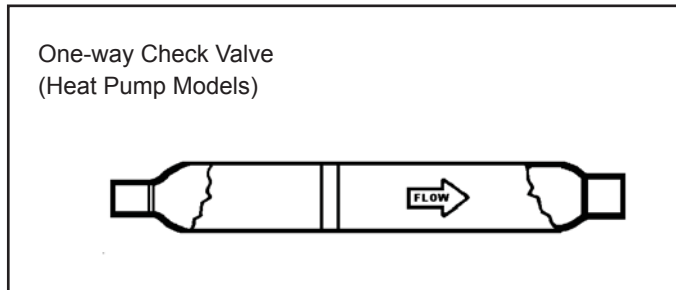

NOTE: The slide (check) inside the valve is made of teflon. Should it become necessary to replace the check valve, place a wet cloth around the valve to prevent overheating during the brazing operation.

CHECK VALVE OPERATION

In the cooling mode of operation, high pressure liquid enters the check valve forcing the slide to close the opposite port (liquid line) to the indoor coil. Refer to refrigerant flow chart. This directs the refrigerant through the filter drier and cooling capillary tube to the indoor coil.

In the heating mode of operation, high pressure refrigerant enters the check valve from the opposite direction, closing the port (liquid line) to the outdoor coil. The flow path of the refrigerant is then through the filter drier and heating capillary to the outdoor coil.

Failure of the slide in the check valve to seat properly in either mode of operation will cause flooding of the cooling coil. This is due to the refrigerant bypassing the heating or cooling capillary tube and entering the liquid line.

COOLING MODE

In the cooling mode of operation, liquid refrigerant from condenser (liquid line) enters the cooling check valve forcing the heating check valve shut. The liquid refrigerant is directed into the liquid dryer after which the refrigerant is metered through cooling capillary tubes to evaporator. (Note: liquid refrigerant will also be directed through the heating capillary tubes in a continuous loop during the cooling mode).

HEATING MODE

In the heating mode of operation, liquid refrigerant from the indoor coil enters the heating check valve forcing the cooling check valve shut. The liquid refrigerant is directed into the liquid dryer after which the refrigerant is metered through the heating capillary tubes to outdoor coils. (Note: liquid refrigerant will also be directed through the cooling capillary tubes in a continuous loop during the heating mode).

REVERSING VALVE DESCRIPTION/OPERATION

⚠ WARNING	
	ELECTRIC SHOCK HAZARD Disconnect power to the unit before servicing. Failure to follow this warning could result in serious injury or death.

The Reversing Valve controls the direction of refrigerant flow to the indoor and outdoor coils. It consists of a pressure-operated, main valve and a pilot valve actuated by a solenoid plunger. The solenoid is energized during the heating cycle only. The reversing valves used in the RAC system is a 2-position, 4-way valve.

The single tube on one side of the main valve body is the high-pressure inlet to the valve from the compressor. The center tube on the opposite side is connected to the low pressure (suction) side of the system. The other two are connected to the indoor and outdoor coils. Small capillary tubes connect each end of the main valve cylinder to the

“A” and “B” ports of the pilot valve. A third capillary is a common return line from these ports to the suction tube on the main valve body. Four-way reversing valves also have a capillary tube from the compressor discharge tube to the pilot valve.

The piston assembly in the main valve can only be shifted by the pressure differential between the high and low sides of the system. The pilot section of the valve opens and closes ports for the small capillary tubes to the main valve to cause it to shift.

NOTE: System operating pressures must be near normal before valve can shift.

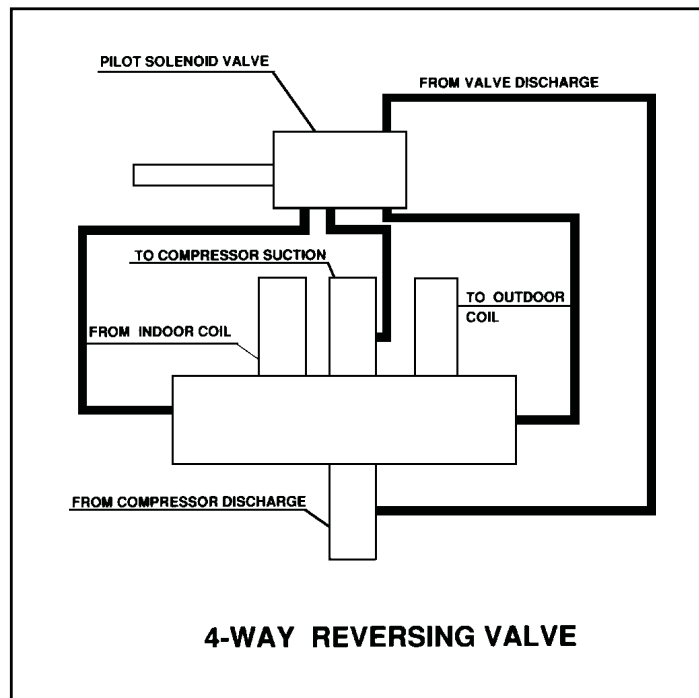

TESTING THE REVERSING VALVE SOLENOID COIL

⚠ WARNING



ELECTRIC SHOCK HAZARD

Unplug and/or disconnect all electrical power to the unit before performing inspections, maintenances or service.

Failure to do so could result in electric shock, serious injury or death.

The solenoid coil is an electromagnetic type coil mounted on the reversing valve and is energized during the operation of the compressor in the heating cycle.

1. Turn off high voltage electrical power to unit.
2. Unplug line voltage lead from reversing valve coil.
3. Check for electrical continuity through the coil. If you do not have continuity replace the coil.
4. Check from each lead of coil to the copper liquid line as it leaves the unit or the ground lug. There should be no continuity between either of the coil leads and ground; if there is, coil is grounded and must be replaced.
5. If coil tests okay, reconnect the electrical leads.
6. Make sure coil has been assembled correctly.

NOTE: Do not start unit with solenoid coil removed from valve, or do not remove coil after unit is in operation. This will cause the coil to burn out.

CHECKING THE REVERSING VALVE

NOTE: You must have normal operating pressures before the reversing valve can shift.

⚠ WARNING

HIGH PRESSURE HAZARD

Sealed Refrigeration System contains refrigerant and oil under high pressure.

Proper safety procedures must be followed, and proper protective clothing must be worn when working with refrigerants.

Failure to follow these procedures could result in serious injury or death.

Check the operation of the valve by starting the system and switching the operation from "Cooling" to "Heating" and then back to "Cooling". Do not hammer on valve.

Occasionally, the reversing valve may stick in the heating or cooling position or in the mid-position.

When sluggish or stuck in the mid-position, part of the discharge gas from the compressor is directed back to the suction side, resulting in excessively high suction pressure.

Should the valve fail to shift from cooling to heating, block the air flow through the outdoor coil and allow the discharge pressure to build in the system. Then switch the system from heating to cooling.

If the valve is stuck in the heating position, block the air flow through the indoor coil and allow discharge pressure to build in the system. Then switch the system from heating to cooling.

Should the valve fail to shift in either position after increasing the discharge pressure, replace the valve.

Dented or damaged valve body or capillary tubes can prevent the main slide in the valve body from shifting.

If you determine this is the problem, replace the reversing valve.

After all of the previous inspections and checks have been made and determined correct, then perform the "Touch Test" on the reversing valve.

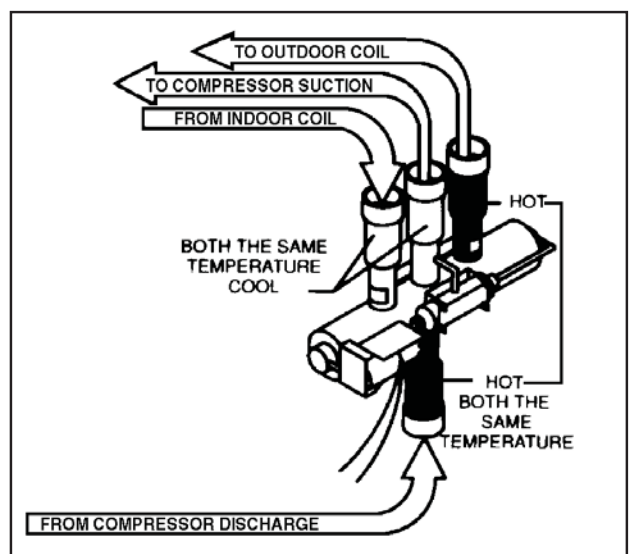
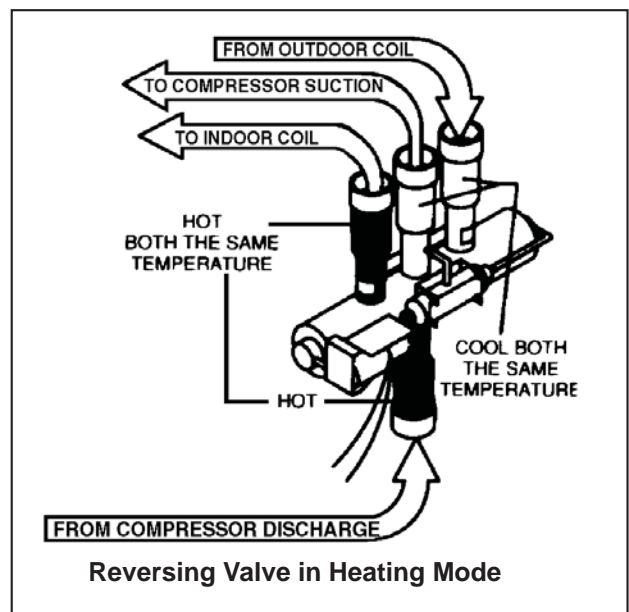

Touch Test in Heating/Cooling Cycle

⚠ WARNING	
	<p>BURN HAZARD</p> <p>Certain unit components operate at temperatures hot enough to cause burns.</p>
	<p>Proper safety procedures must be followed, and proper protective clothing must be worn.</p>
	<p>Failure to follow these procedures could result in minor to moderate injury.</p>

The only definite indications that the slide is in the mid-position is if all three tubes on the suction side of the valve are hot after a few minutes of running time.

NOTE: A condition other than those illustrated above, and on Page 44, indicate that the reversing valve is not shifting properly. Both tubes shown as hot or cool must be the same corresponding temperature.

Procedure For Changing Reversing Valve

⚠ WARNING	
	<p>HIGH PRESSURE HAZARD</p> <p>Sealed Refrigeration System contains refrigerant and oil under high pressure.</p>
	<p>Proper safety procedures must be followed, and proper protective clothing must be worn when working with refrigerants.</p>
	<p>Failure to follow these procedures could result in serious injury or death.</p>

NOTICE	
<p>FIRE HAZARD</p>	
<p>The use of a torch requires extreme care and proper judgment. Follow all safety recommended precautions and protect surrounding areas with fire proof materials. Have a fire extinguisher readily available. Failure to follow this notice could result in moderate to serious property damage.</p>	

1. Install Process Tubes. Recover refrigerant from sealed system. **PROPER HANDLING OF RECOVERED REFRIGERANT ACCORDING TO EPA REGULATIONS IS REQUIRED.**
2. Remove solenoid coil from reversing valve. If coil is to be reused, protect from heat while changing valve.
3. Unbrazed all lines from reversing valve.
4. Clean all excess braze from all tubing so that they will slip into fittings on new valve.
5. Remove solenoid coil from new valve.

6. Protect new valve body from heat while brazing with plastic heat sink (Thermo Trap) or wrap valve body with wet rag.
7. Fit all lines into new valve and braze lines into new valve.

⚠ WARNING	
	<p>EXPLOSION HAZARD</p> <p>The use of nitrogen requires a pressure regulator. Follow all safety procedures and wear protective safety clothing etc.</p>
	<p>Failure to follow proper safety procedures could result in serious injury or death.</p>

8. Pressurize sealed system with a combination of R-410A and nitrogen and check for leaks, using a suitable leak detector. Recover refrigerant per EPA guidelines.
9. Once the sealed system is leak free, install solenoid coil on new valve and charge the sealed system by weighing in the proper amount and type of refrigerant as shown on rating plate. Crimp the process tubes and solder the ends shut. Do not leave Schrader or piercing valves in the sealed system.

NOTE: When brazing a reversing valve into the system, it is of extreme importance that the temperature of the valve does not exceed 250°F at any time.

Wrap the reversing valve with a large rag saturated with water. "Re-wet" the rag and thoroughly cool the valve after each brazing operation of the four joints involved.

The wet rag around the reversing valve will eliminate conduction of heat to the valve body when brazing the line connection.

COMPRESSOR CHECKS

⚠ WARNING	
	ELECTRIC SHOCK HAZARD Turn off electric power before service or installation. Extreme care must be used, if it becomes necessary to work on equipment with power applied. Failure to do so could result in serious injury or death.

Locked Rotor Voltage (L.R.V.) Test

Locked rotor voltage (L.R.V.) is the actual voltage available at the compressor under a stalled condition.

Single Phase Connections

Disconnect power from unit. Using a voltmeter, attach one lead of the meter to the run "R" terminal on the compressor and the other lead to the common "C" terminal of the compressor. Restore power to unit.

Determine L.R.V.

Start the compressor with the volt meter attached; then stop the unit. Attempt to restart the compressor within a couple of seconds and immediately read the voltage on the meter. The compressor under these conditions will not start and will usually kick out on overload within a few seconds since the pressures in the system will not have had time to equalize. Voltage should be at or above minimum voltage of 197 VAC, as specified on the rating plate. If less than minimum, check for cause of inadequate power supply; i.e., incorrect wire size, loose electrical connections, etc.

Amperage (L.R.A.) Test

The running amperage of the compressor is the most important of these readings. A running amperage higher than that indicated in the performance data indicates that a problem exists mechanically or electrically.

Single Phase Running and L.R.A. Test

NOTE: Consult the specification and performance section for running amperage. The L.R.A. can also be found on the rating plate.

Select the proper amperage scale and clamp the meter probe around the wire to the "C" terminal of the compressor.

Turn on the unit and read the running amperage on the meter. If the compressor does not start, the reading will indicate the locked rotor amperage (L.R.A.).

Overloads

The compressor is equipped with either an external or internal overload which senses both motor amperage and winding temperature. High motor temperature or amperage heats the overload causing it to open, breaking the common circuit within the compressor.

Heat generated within the compressor shell, usually due to recycling of the motor, is slow to dissipate. It may take anywhere from a few minutes to several hours for the overload to reset.

Checking the Overloads

⚠ WARNING	
	ELECTRIC SHOCK HAZARD Turn off electric power before service or installation. Extreme care must be used, if it becomes necessary to work on equipment with power applied. Failure to do so could result in serious injury or death.

⚠ WARNING	
	BURN HAZARD Certain unit components operate at temperatures hot enough to cause burns. Proper safety procedures must be followed, and proper protective clothing must be worn. Failure to follow this warning could result in moderate to serious injury.

External Overloads

With power off, remove the leads from compressor terminals. If the compressor is hot, allow the overload to cool before starting check. Using an ohmmeter, test continuity across the terminals of the external overload. If you do not have continuity; this indicates that the overload is open and must be replaced.

Internal Overloads

Some model compressors are equipped with an internal overload. The overload is embedded in the motor windings to sense the winding temperature and/or current draw. The overload is connected in series with the common motor terminal.

Should the internal temperature and/or current draw become excessive, the contacts in the overload will open, turning off the compressor. The overload will automatically reset, but may require several hours before the heat is dissipated.

Checking the Internal Overload

1. With no power to unit, remove the leads from the compressor terminals.
2. Using an ohmmeter, test continuity between terminals C-S and C-R. If no continuity, the compressor overload is open and the compressor must be replaced.

Single Phase Resistance Test

⚠ WARNING



ELECTRIC SHOCK HAZARD
Turn off electric power before service or installation. Extreme care must be used, if it becomes necessary to work on equipment with power applied.

Failure to do so could result in serious injury or death.

Remove the leads from the compressor terminals and set the ohmmeter on the lowest scale (R x 1).

Touch the leads of the ohmmeter from terminals common to start ("C" to "S"). Next, touch the leads of the ohmmeter from terminals common to run ("C" to "R").

Add values "C" to "S" and "C" to "R" together and check resistance from start to run terminals ("S" to "R"). Resistance "S" to "R" should equal the total of "C" to "S" and "C" to "R."

In a single phase PSC compressor motor, the highest value will be from the start to the run connections ("S" to "R"). The next highest resistance is from the start to the common connections ("S" to "C"). The lowest resistance is from the run to common. ("C" to "R") Before replacing a compressor, check to be sure it is defective.

GROUND TEST

Use an ohmmeter set on its highest scale. Touch one lead to the compressor body (clean point of contact as a good connection is a must) and the other probe in turn to each compressor terminal. If a reading is obtained the compressor is grounded and must be replaced.

Check the complete electrical system to the compressor and compressor internal electrical system, check to be certain that compressor is not out on internal overload.

Complete evaluation of the system must be made whenever you suspect the compressor is defective. If the compressor has been operating for sometime, a careful examination must be made to determine why the compressor failed.

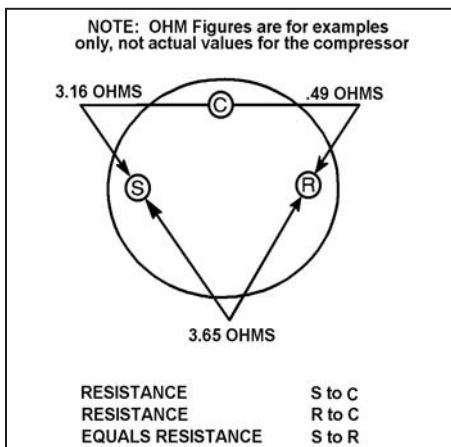

Many compressor failures are caused by the following conditions:

1. Improper air flow over the evaporator.
2. Overcharged refrigerant system causing liquid to be returned to the compressor.
3. Restricted refrigerant system.
4. Lack of lubrication.
5. Liquid refrigerant returning to compressor causing oil to be washed out of bearings.
6. Noncondensables such as air and moisture in the system. Moisture is extremely destructive to a refrigerant system.
7. Capacitor (see page 34).

CHECKING COMPRESSOR EFFICIENCY

The reason for compressor inefficiency is normally due to broken or damaged suction and/or discharge valves, reducing the ability of the compressor to pump refrigerant gas.

⚠ WARNING



HIGH PRESSURE HAZARD
Sealed Refrigeration System contains refrigerant and oil under high pressure.

Proper safety procedures must be followed, and proper protective clothing must be worn when working with refrigerants.

Failure to follow these procedures could result in serious injury or death.

This condition can be checked as follows:

1. Install a piercing valve on the suction and discharge or liquid process tube.
2. Attach gauges to the high and low sides of the system.
3. Start the system and run a "cooling or heating performance test." If test shows:
 - A. **Below** normal high side pressure
 - B. **Above** normal low side pressure
 - C. **Low** temperature difference across coil

The compressor valves are faulty - replace the compressor.

COMPRESSOR REPLACEMENT

Recommended procedure for compressor replacement

⚠ WARNING	
	RISK OF ELECTRIC SHOCK Unplug and/or disconnect all electrical power to the unit before performing inspections, maintenances or service.
	Failure to do so could result in electric shock, serious injury or death.

1. Be certain to perform all necessary electrical and refrigeration tests to be sure the compressor is actually defective before replacing.

⚠ WARNING	
	HIGH PRESSURE HAZARD Sealed Refrigeration System contains refrigerant and oil under high pressure.
	Proper safety procedures must be followed, and proper protective clothing must be worn when working with refrigerants. Failure to follow these procedures could result in serious injury or death.

2. Recover all refrigerant from the system through the process tubes. **PROPER HANDLING OF RECOVERED REFRIGERANT ACCORDING TO EPA REGULATIONS IS REQUIRED.** Do not use gauge manifold for this purpose if there has been a burnout. You will contaminate your manifold and hoses. Use a Schrader valve adapter and copper tubing for burnout failures.

⚠ WARNING	
	HIGH TEMPERATURES Extreme care, proper judgment and all safety procedures must be followed when testing, troubleshooting, handling or working around unit while in operation with high temperature components. Wear protective safety aids such as: gloves, clothing etc.
	Failure to do so could result in serious burn injury.

NOTICE	
FIRE HAZARD The use of a torch requires extreme care and proper judgment. Follow all safety recommended precautions and protect surrounding areas with fire proof materials. Have a fire extinguisher readily available. Failure to follow this notice could result in moderate to serious property damage.	

3. After all refrigerant has been recovered, disconnect suction and discharge lines from the compressor and remove compressor. Be certain to have both suction and discharge process tubes open to atmosphere.
4. Carefully pour a small amount of oil from the suction stub of the defective compressor into a clean container.
5. Using an acid test kit (one shot or conventional kit), test the oil for acid content according to the instructions with the kit.
6. If any evidence of a burnout is found, no matter how slight, the system will need to be cleaned up following proper procedures.
7. Install the replacement compressor.

⚠ WARNING	
	EXPLOSION HAZARD The use of nitrogen requires a pressure regulator. Follow all safety procedures and wear protective safety clothing etc.
	Failure to follow proper safety procedures result in serious injury or death.

8. Pressurize with a combination of R-410A and nitrogen and leak test all connections with an electronic or Halide leak detector. Recover refrigerant and repair any leaks found.

Repeat Step 8 to insure no more leaks are present.

9. Evacuate the system with a good vacuum pump capable of a final vacuum of 200 microns or less. The system should be evacuated through both liquid line and suction line gauge ports. While the unit is being evacuated, seal all openings on the defective compressor. Compressor manufacturers will void warranties on units received not properly sealed. Do not distort the manufacturers tube connections.

⚠ CAUTION	
	FREEZE HAZARD Proper safety procedures must be followed, and proper protective clothing must be worn when working with liquid refrigerant.
	Failure to follow these procedures could result in minor to moderate injury.

10. Recharge the system with the correct amount of refrigerant. The proper refrigerant charge will be found on the unit rating plate. The use of an accurate measuring device, such as a charging cylinder, electronic scales or similar device is necessary.

SPECIAL PROCEDURE IN THE CASE OF MOTOR COMPRESSOR BURNOUT

⚠ WARNING	
	<p>ELECTRIC SHOCK HAZARD Turn off electric power before service or installation.</p> <p>Failure to do so may result in personal injury, or death.</p>

⚠ WARNING	
	<p>HIGH PRESSURE HAZARD Sealed Refrigeration System contains refrigerant and oil under high pressure.</p> <p>Proper safety procedures must be followed, and proper protective clothing must be worn when working with refrigerants.</p> <p>Failure to follow these procedures could result in serious injury or death.</p>

⚠ WARNING	
	<p>EXPLOSION HAZARD The use of nitrogen requires a pressure regulator. Follow all safety procedures and wear protective safety clothing etc.</p> <p>Failure to follow proper safety procedures result in serious injury or death.</p>

1. Recover all refrigerant and oil from the system.
2. Remove compressor, capillary tube and filter drier from the system.
3. Flush evaporator condenser and all connecting tubing with dry nitrogen or equivalent. Use approved flushing agent to remove all contamination from system. Inspect suction and discharge line for carbon deposits. Remove and clean if necessary. Ensure all acid is neutralized.
4. Reassemble the system, including new drier strainer and capillary tube.
5. Proceed with step 8-10 on previous page.

ROTARY AND SCROLL COMPRESSOR SPECIAL TROUBLESHOOTING AND SERVICE

Basically, troubleshooting and servicing rotary compressors is the same as on the reciprocating compressor with only one main exception:

NEVER, under any circumstances, liquid charge a rotary compressor through the **LOW** side. Doing so would cause permanent damage to the new compressor.

ROUTINE MAINTENANCE

⚠ WARNING



ELECTRIC SHOCK HAZARD

Turn off electric power before inspections, maintenances, or service.

Extreme care must be used, if it becomes necessary to work on equipment with power applied.

Failure to do so could result in serious injury or death.

⚠ WARNING



EXCESSIVE WEIGHT HAZARD

Use two people to lift or carry the unit, and wear proper protective clothing.

Failure to do so may result in personal injury.

⚠ WARNING



CUT/SEVER HAZARD

Be careful with the sharp edges and corners. Wear protective clothing and gloves, etc.

Failure to do so could result in serious injury.

NOTICE

Units are to be inspected and serviced by qualified service personnel only. Use proper protection on surrounding property. Failure to follow this notice could result in moderate or serious property damage.

NOTICE

Do not use a caustic coil cleaning agent on coils or base pan. Use a biodegradable cleaning agent and degreaser, to prevent damage to the coil and/or base pan.

COILS AND BASE PAN

The indoor coil (evaporator coil), the outdoor coil (condenser coil) and base pan should be inspected periodically (yearly or bi-yearly) and cleaned of all debris (lint, dirt, leaves, paper, etc.). Clean the coils and base pan with a soft brush and compressed air or vacuum. If using a pressure washer, be careful not to bend the aluminium fin pack. Use a sweeping up and down motion in the direction of the vertical aluminum fin pack when pressure cleaning coils. Cover all electrical components to protect them from water or spray. Allow the unit to dry thoroughly before reinstalling it in the sleeve.

NOTE: Do not use a caustic coil cleaning agent on coils or base pan. Use a biodegradable cleaning agent and degreaser. The use of harsh cleaning materials may lead to deterioration of the aluminum fins or the coil end plates.

NOTE: It is extremely important to insure that none of the electrical and/or electronic parts of the unit get wet. Be sure to cover all electrical components to protect them from water or spray.

BLOWER WHEEL / HOUSING / CONDENSER FAN / SHROUD

Inspect the indoor blower and its housing, evaporator blade, condenser fan blade and condenser shroud periodically (yearly or bi-yearly) and clean of all debris (lint, dirt, mold, fungus, etc.). Clean the blower housing area and blower wheel with an antibacterial / antifungal cleaner. Use a biodegradable cleaning agent and degreaser on condenser fan and condenser shroud. Use warm or cold water when rinsing these items. Allow all items to dry thoroughly before reinstalling them.

ELECTRONIC / ELECTRICAL / MECHANICAL

Periodically (at least yearly or bi-yearly): inspect all control components: electronic, electrical and mechanical, as well as the power supply. Use proper testing instruments (voltmeter, ohmmeter, ammeter, wattmeter, etc.) to perform electrical tests. Use an air conditioning or refrigeration thermometer to check room, outdoor and coil operating temperatures.

BLOWER/FAN MOTOR

The motor is permanently lubricated.

AIR FILTER

The air filter should be inspected weekly and cleaned if needed by vacuuming with a dust attachment or by cleaning in the sink using warm water and a mild dishwashing detergent. Dry the filter thoroughly before reinstalling. Use caution as the coil surface can be sharp.

TO REMOVE, WASH AND REPLACE FILTER

Lower front panel. Use handle on filter to flex filter up and out of retainer. Remove filter from unit. Clean filter monthly or more frequently if needed. Refer to accessories section for filter options.

ROUTINE MAINTENANCE (Continued)

NOTICE

Do not drill holes in the bottom of the drain pan or the underside of the unit. Not following this notice could result in damage to the unit or condensate water leaking inappropriately which could cause water damage to surrounding property.

SLEEVE / DRAIN

Inspect the sleeve and drain system periodically (at least yearly or bi-yearly) and clean of all obstructions and debris. Clean both areas with an antibacterial and antifungal cleaner. Rinse both items thoroughly with water and ensure that the drain outlets are operating correctly. Check the sealant around the sleeve and reseal areas as needed.

DECORATIVE FRONT COVER

Clean the front cover when needed. Use a mild detergent. Wash and rinse with warm water. Allow it to dry thoroughly before reinstalling it in the chassis.

The decorative front and the cabinet can be cleaned with warm water and a mild liquid detergent. Do NOT use solvents or hydrocarbon based cleaners such as acetone, naphtha, gasoline, benzene, etc.

Use a damp (not wet) cloth when cleaning the control area to prevent water from entering the unit, and possibly damaging the electronic control.

CLEARANCES

Inspect the surrounding area (inside and outside) to ensure that the unit's clearances have not been compromised or altered.

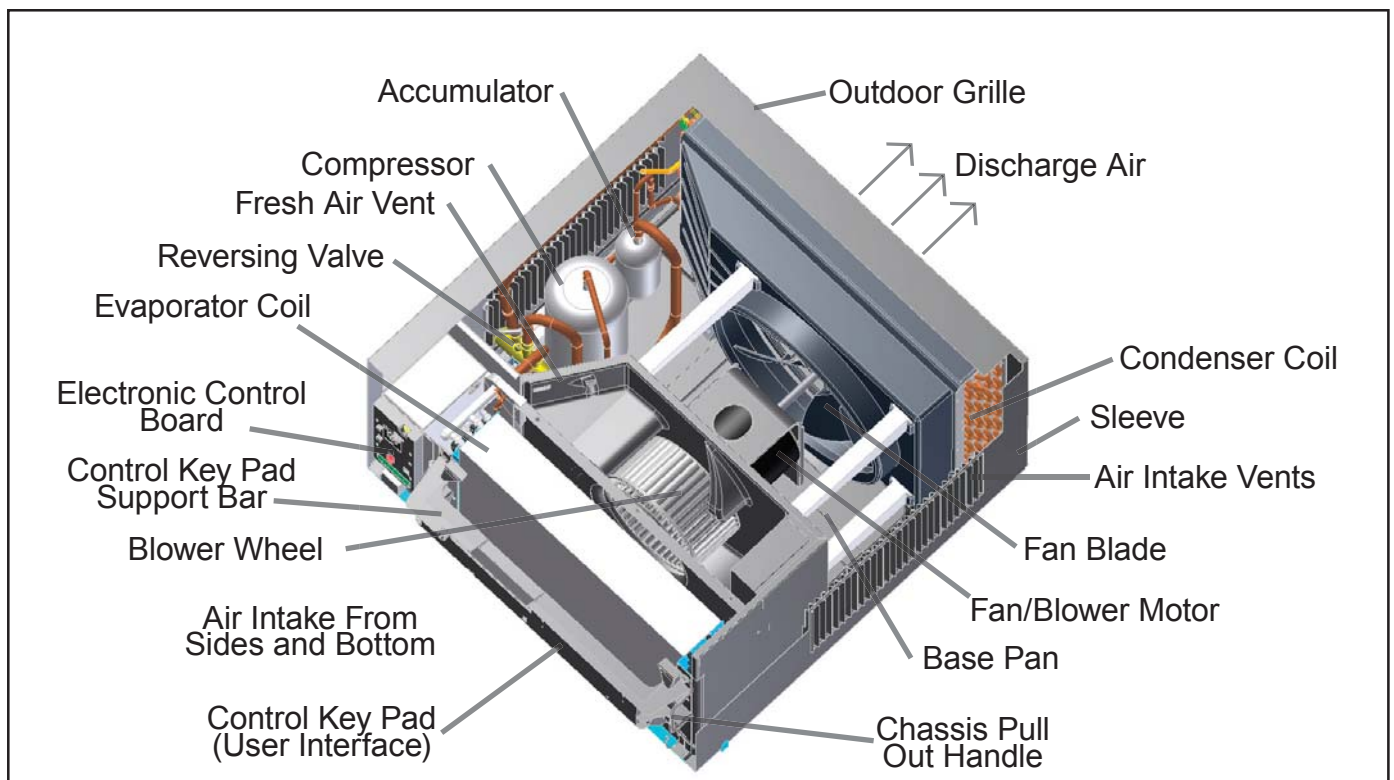

ROUTINE MAINTENANCE (Continued)

Standard Filter Cleaning Installation Instructions

STEP 1. Swing the door open and remove the filter by grasping the filter grip and pushing the filter holder upward and outward.

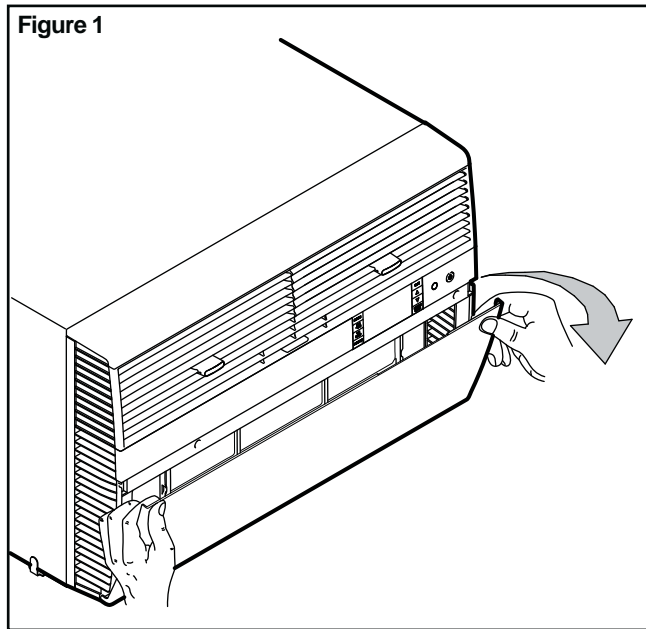

Remove the filter by grabbing it from its handle, lifting it up and swinging it out.

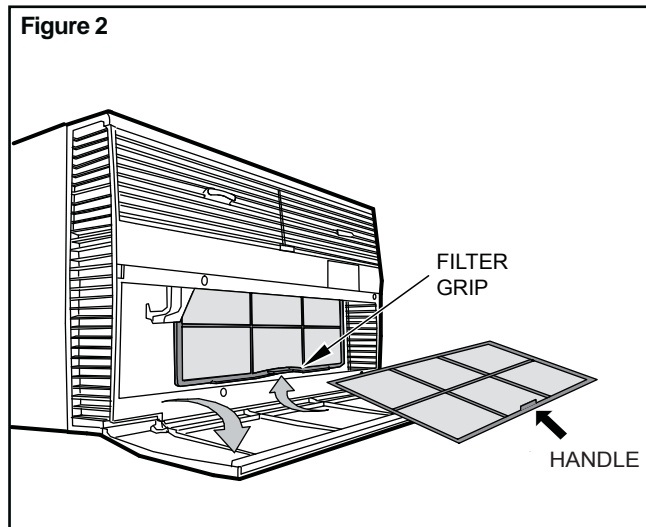

STEP 2. Slide the filter grip out from the filter as shown in Figure 3.

NOTE: Make sure the front frame with the mesh filter is facing you.

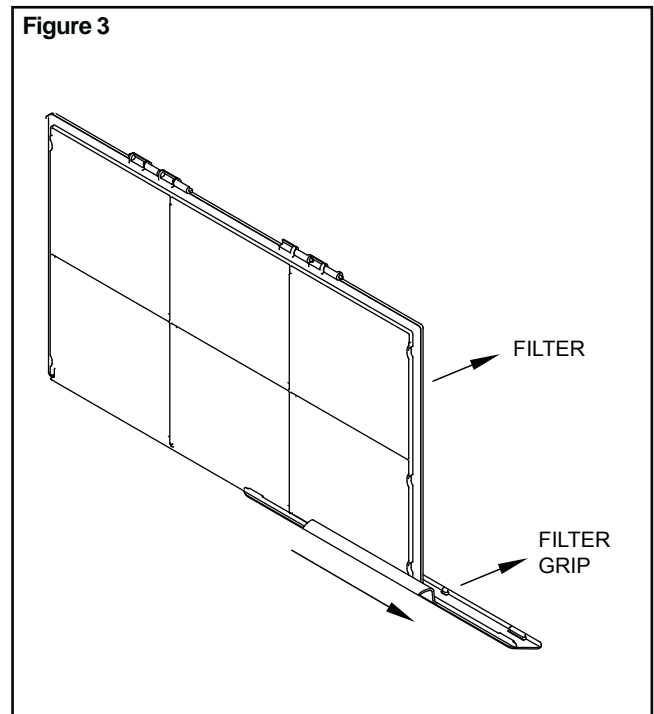

STEP 3. Swing the front frame open. Clean the front frame by washing the dirt from the filter. Use a mild soap solution if necessary. Allow filter to dry.

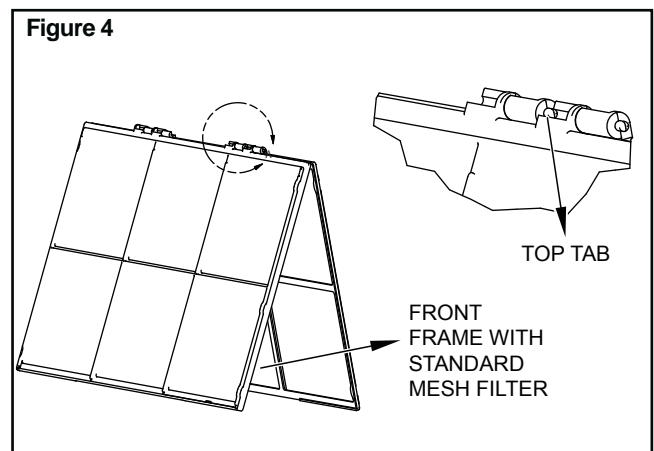

STEP 4. Install the filter grip back into the filter by sliding it into the filter.

STEP 5. Install the filter back into the unit. Follow the Instructions on the inside of the front door.

NOTE: The filter handle slides into the frame in only one direction. If the tab in the frame stops the handle from sliding in, slide the filter halfway up, tilt it towards the front of you, then gently slide it up fully. Do not force the handle into the frame.

ROUTINE MAINTENANCE (Continued)

After Maintenance/Repair Start-up Checklist and Notes

- ◆ Inspect and ensure that all components and accessories have been installed properly and that they have not been damaged during the installation progress.
- ◆ Check the condensate water drain(s) to ensure that they are adequate for the removal of condensate water, and that they meet the approval of the end user.
- ◆ Ensure that all installation instructions concerning clearances around the unit have been adhered to. Check to ensure that the unit air filter, indoor coil, and outdoor coil are free from any obstructions.
- ◆ Ensure that the circuit breaker(s) or fuse(s) and supply circuit wire size have been sized correctly. If the unit was supplied with a power supply cord, insure that it is stored properly.
- ◆ Ensure that the entire installation is in compliance with all applicable national and local codes and ordinances having jurisdiction.
- ◆ Secure components and accessories, such as a decorative front cover.
- ◆ Start the unit and check for proper operation of all components in each mode of operation.
- ◆ Instruct the owner or operator of the units operation, and the manufacturer's Routine Maintenance.

NOTE: A log for recording the dates of maintenance and/or service is recommended.

- ◆ Present the owner or operator of the equipment with the name, address and telephone number of the Authorized Friedrich Warranty Service Company in the area for future reference if necessary.

NOTE: This is a warm weather appliance

The air conditioner is designed to cool in warm weather when the outside temperature is above 60° F (15.6° C) and below 115° F (46.1° C), so it won't cool a room if it is already cool outside. If you want to cool a room in the spring or fall, select the FAN ONLY  mode and set the Fresh Air/Exhaust air control to Fresh Air. This will bring in a supply of cooler outside air.

Condensation is normal

Air conditioners actually pump the heat and humidity from your room to the outside. Humidity becomes water, and your air conditioner will use most of the water to keep the outside coil cool. If there is excessive humidity, there may be excess water that will drip outside. This is normal operation.

Frosting

This usually occurs because of insufficient airflow across the coils, a dirty filter, cool damp weather, or all of these. Set the SYSTEM mode to FAN ONLY  and the frost will disappear. Setting the thermostat a little warmer will probably prevent the frosting from recurring.

Noises

All air conditioners make some noise. Friedrich units are designed to operate as quietly as possible. An air conditioner mounted in a wall is quieter than one mounted in a window. It is important to ensure that the chassis seal gasket is properly installed (refer to installation instructions).

Heat pumps operate differently

If your unit is a "Y", or heat pump model, there are some things that you will want to be aware of. Some functions of a heat pump differ from your unit when it is used for heating:

1. It is normal for ice to form on the outdoor coil of the heat pump. Moisture in the outside air, passing over the coil when very cold, will form ice.
2. If the outdoor temperature drops below 37° F (3° C), your heat pump will automatically turn on the electric resistance heat. When the temperature rises to 40° F (4° C), the compressor will resume the heat pump operation. If your unit is a 115 volt model (YS10), it is designed for use in warmer climates and does not have an electrical heat feature, and will not provide adequate heat below 37° F (2.8° C).

CONTROL PANEL BATTERY CHANGE PROCEDURE

Remove the grille, by loosening four (4) captive screws (See Figure 1). Remove one (1) screw on the battery retaining door (See Figure 2). Remove and replace the battery (CR2450). Reinstall the battery retaining door. Align the grille guide pins then tighten the four (4) captive screws. Before closing the grille panel door, check the filter. Clean or replace it as necessary.

Figure 1

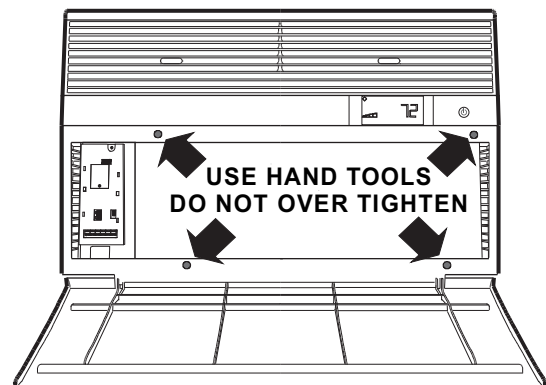

1. USE HAND TOOLS WHEN INSTALLING AND REMOVING FRONT PANEL. DO NOT OVERTIGHTEN SCREWS.



2. DISCONNECT POWER AND FOLLOW ALL LABELED WARNINGS WHEN FRONT PANEL IS REMOVED.

Figure 2

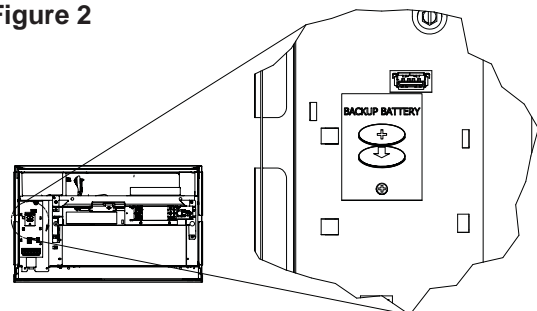

Battery type: Lithium, 3 Volts, #CR2450

Service and Assistance

Before calling for service, please check the “Troubleshooting Tips” section on pages 40 and 41. This may help you to find the answer to your problem, avoid unnecessary service calls, and save you the cost of a service call if the problem is not due to the product itself. If you have checked the “Basic Troubleshooting” section and still need help, it is available as follows:

You can find the name of your local Authorized Service Provider by visiting our web site at www.friedrich.com.

If you require further assistance

You can call the Customer Support Call Center at 1-800-541-6645.

Before calling, please make sure that you have the complete model and serial number, and date of purchase of your equipment available. By providing us with this information, we will be better able to assist you.

Our specialists are able to assist you with:

- ◆ Specifications and Features of our equipment.
- ◆ Referrals to dealers, and distributors.
- ◆ Use and Care Information.
- ◆ Recommended maintenance procedures.
- ◆ Installation information.
- ◆ Referrals to Authorized Service Providers and Parts depots.

Available Accessories

DC-2 Drain Kit – Part No. 01900235

In some installations, excess condensate water caused by extremely humid conditions, may result in an undesirable water drip such as on a patio or over an entryway. MODEL DC-2 DRAIN KIT (Part No. 01900-235) can be installed to drain excess condensation to an alternate location.

Carbon Filter Kits

The kits vary depending on the chassis size (small, medium, large). Each kit contains three (3) filters.

WCFS – Carbon filter kit for small chassis models.

WCFM – Carbon filter kit for medium chassis models.

WCFL – Carbon filter kit for large chassis models.

Remote Wall Thermostats

RT4 – Digital wall thermostat hard wired with single speed fan.

RT5 – Digital wall thermostat hard wired with a digital display, two fan speed selection, filter check light, temperature limiting, status indicator light, room temperature offset, backlight and battery backup.

Window Installation Kits (Standard in Kühl Models without Heat)

KWIKS – For all ES and YS models.

KWIKM – For all EM and YM models.

KWIKL – For all EL and YL models.

See www.friedrich.com for additional accessories for your unit.



FRIEDRICH

ROOM AIR CONDITIONER UNIT PERFORMANCE TEST DATA SHEET

JOB NAME _____ TECHS NAME _____

DATE: _____ MODEL: _____ SERIAL: _____

HOW IS ALL OF THE INSTALLATION?	GOOD YES	BAD NO
IS A CHASSIS SEAL GASKET INTALLED ?	_____	_____
IS THE FRESH/EXHAUST AIR VENT OPEN?	_____	_____
IS A FRIEDRICH SLEEVE INSTALLED?	_____	_____
IS A FRIEDRICH OUTDOOR GRILLE INSTALLED?	_____	_____
IS MAINTENANCE BEING PERFORMED?	_____	_____

If **NO** is checked use back of sheet for explanation

ELECTRICAL:

LINE VOLTAGE (STATIC) ----- VOLTS

START UP VOLTAGE ----- VOLTS

AMPERAGE DRAW ----- AMPS (COOL)

AMPERAGE DRAW ----- AMPS (HEAT)

COMPRESSOR

LOCKED ROTOR AMPS ----- AMPS

AMPERAGE DRAW ----- AMPS

INDOOR TEMPERATURES:

INDOOR AMBIENT TEMPERATURE ----- F

RELATIVE HUMIDITY (RH) INDOOR ----- %

DISCHARGE AIR TEMPERATURE (INDOOR) ----- F COOL HEAT

RETURN AIR TEMPERATURE (INDOOR) ----- F ----- F

OUTDOOR TEMPERATURE:

OUTDOOR AMBIENT TEMPERATURE ----- F

RH OUTDOOR ----- %

DISCHARGE AIR TEMPERATURE (OUTDOOR) ----- F ----- F

INTAKE AIR TEMPERATURE (OUTDOOR) ----- F ----- F

APPLICATION USE ----- ROOM (RESIDENTIAL OR COMMERCIAL)

COOLING OR HEATING AREA W ----- X L ----- X H ----- = SQ/CU/FT -----

This is a general guide. please consult manual J or M.

Sizing your air conditioner correctly is vital.

Sizing Guide

The following guide is based on normal room insulation, average number of sun-exposed windows and two-person occupancy.

FT ²	Btu/h
100-150	5,000
150-250	6,000
250-300	7,000
300-350	8,000
350-400	9,000
400-450	10,000
450-550	12,000
550-700	14,000
700-1,000	18,000
1,000-1,200	21,000
1,200-1,400	23,000
1,400-1,600	25,000
1,600-1,900	28,000
1,900-2,700	36,000

This is a general guide.
Please consult manual J or M for exact load calculations.

Due to variations in room design, climate zone and occupancy, larger areas may require the use of multiple units to provide the optimal cooling solution.

ERROR CODES AND ALARM STATUS

Error Code	Maintenance ICON	Problem	Control Board's Action
1	Flash	Front Panel Button Stuck For More Than 20 Seconds	Continue to monitor for "OPEN" (Unstuck) switch. Do not process switch input. ENSURE FRONT COVER DOES NOT DEPRESS BUTTONS
2	Flash	Input Voltage Out of Specification (103 - 127 / 187 - 253)	Stop.Open all relays until voltage is back within specs. Resume operation
3	Flash	Indoor Temperature Sensor is Open or Shorted	Set temp to 75°F in COOLING or 68°F in HEATING. Unit continues to operate
4	Flash	Indoor Coil Temperature Sensor is Open or Shorted	Control Board sets temp to 40°F. Override sensor. Unit Continues to operate.
5	Flash	Outdoor Coil Temperature Sensor is Open or Shorted	Sets temp to 20°F. Override sensor. Continue operation. Use Elec Heat if available for HEATING. If not available use HEAT PUMP if outdoor temp allows.
6	Flash	Outdoor Coil > (grater than) 175 F	Shut down for 5 min. Resume operation for 3 min. Continues to monitor. If test fails 3 times, the severity is increased and the unit operation is locked out.
7	Flash	Indoor Coil < (less than) 30 F for 2 consecutive minutes	Turn compressor off. Run High Fan speed. When coil temp reaches 45°F resume operation after lockout time.
8	Log Only	Unit Cycles > (grater than) 9 Times per hour	Continue operation. Continue to monitor. Take no action. Log Only.
9	Log Only	Unit Cycles < (less than) 3 Times per Hour	Continue operation. Continue to monitor. Take no action. Log Only.
10	Log Only	Room Freeze Protection	Only used if Electric Heat is available. Run High Speed and Electric heat until room temp reaches 46°F. Display "FRZ" during operation. Logged Only
11	On	WallStat Problem or Connection Issue	Severity 4 error is. Unit operates based on standard input mapping. Severity 2 error opens all relays. Unit will not operate.
12	Flash	Discharge Air > (greater than) 185 F	Shutdown heat pump and electric heater. Run high fan speed until temp is 100°F. Resume operation. Third occurrence in 1 hour locks unit out.
13	Flash	Prerssure Limit Switch Open	If unit is cooling or heat pump on,shut down compressor. Run high fan until switch closes. Resume operation. Third occurrence in 1 hour locks unit out.
14	Flash	Discharge Air Temperature Sensor is Open or Shorted	Override Sensor. Set temp to 75°F. Continue to monitor. Set error code 14 ON.
15	Solid On	Heat Pump Error	If indoor coil temp < (Lesser than) ambient temp for 3 minutes. Unit uses electric heat to satisfy heating demand.
16	Flash	Temperature Beyond Operating Limits	Ambient temp < (less than) 0°F and ambient temp > (greater than) 130°F. Set error code 16 ON. When cleared return unit to normal.
17	Flash	Equipment Doesn't Meet Minimum Configuration	Must have compressor enabled and at least 2 fan speeds
18	Flash	Special Test 1 Severity Level 1	Unit shuts down. Inputs via front panel or t-stat are ignored. Qualified Technical Service required URGENT
19	Flash	Special Test 2 Severity Level 2	Unit operates. Qualified Technical Service required
20	Solid On	Special Test 3 Severity Level 3	Error is Logged Only. Unit operates. Severity 3 keeps unit running. Attention is needed
21	OFF, Log Only	Special Test 4 Severity Level 4	Error is Logged Only. Unit operates. Severity 4 keeps unit running.
22	OFF, Log Only	Outdoor Coil Temperature < 30 F for 2 consecutive Minutes	Unit will use electric heat to satisfy heating demands until temp > 45°F. Unit must be a Heat Pump.
23	OFF, Log Only	Frost Protection (for Heat Pump Only Unit- YS10M10)	Unit will run active defrost for a minimum of 6 minutes when Heat Pump run time is greater than 60 minutes and outdoor coil temp is 26 F or less.
24	Flash	Outdoor Air Temperature Sensor is Open or Shorted	Continue with normal operation. Continue to monitor sensor.

Key Sequence	Action
Enter Maintenance Menu	Press SYSTEM + SCHEDULE + BACK + DISPLAY/ENTER for 6 secs or until double beep sounds(🔔)
Reset Error Codes & Error History	Press ▲ + ▼ for 3 secs or until double beep sounds (🔔)

TROUBLESHOOTING TIPS

NOTE: To more accurately identify the problem, first check for current maintenance alerts and their history.

Problem	Possible Cause	Possible Solution
Unit does not operate.	The unit is turned to the off position, or the thermostat is satisfied.	Turn the unit to the on position and raise or lower temperature setting (as appropriate) to call for operation.
	The LCDI power cord is unplugged.	Plug into a properly grounded 3 prong receptacle. See "Electrical Rating Tables" on pg. 6 for the proper receptacle type for your unit.
	The LCDI power cord has tripped (Reset button has popped out).	Press and release RESET (listen for click; Reset button latches and remains in) to resume operation.
	The circuit breaker has tripped or the supply circuit fuse has blown.	Reset the circuit breaker, or replace the fuse as applicable. If the problem continues, contact a licensed electrician.
	There has been a local power failure.	The unit will resume normal operation once power has been restored.
Unit Trips Circuit Breaker or Blows Fuses.	Other appliances are being used on the same circuit.	The unit requires a dedicated outlet circuit, not shared with other appliances.
	An extension cord is being used.	Do NOT use an extension cord with this or any other air conditioner.
	The circuit breaker or time-delay fuse is not of the proper rating.	Replace with a circuit breaker or time-delay fuse of the proper rating. See "Electrical Rating Tables" on pg. 6 for the proper circuit breaker/fuse rating for your unit. If the problem continues, contact a licensed electrician.
LCDI Power Cord Trips (Reset Button Pops Out).	The LCDI power cord can trip (Reset button pops out) due to disturbances on your power supply line.	Press and release RESET (listen for click; Reset button latches and remains in) to resume normal operation.
	Electrical overload, overheating, or cord pinching can trip (Reset button pops out) the LCDI power cord.	Once the problem has been determined and corrected, press and release RESET (listen for click; Reset button latches and remains in) to resume normal operation.
	NOTE: A damaged power supply cord must be replaced with a new power supply cord obtained from the product manufacturer and must not be repaired.	
Unit Does Not Cool/Heat Room Sufficiently, Or Cycles On And Off Too Frequently.	The return/discharge air grille is blocked.	Ensure that the return and/or discharge air paths are not blocked by curtains, blinds, furniture, etc.
	Windows or doors to the outside are open.	Ensure that all windows and doors are closed.
	The temperature is not set at a cool enough/warm enough setting.	Adjust the Temperature control to a cooler or warmer setting as necessary.
	The filter is dirty or obstructed.	Clean the filter, (See Routine Maintenance), or remove obstruction.
	The indoor coil or outdoor coil is dirty or obstructed.	Clean the coils, (See Routine Maintenance), or remove obstruction.
	There is excessive heat or moisture (cooking, showers, etc.) in the room.	Be sure to use exhaust vent fans while cooking or bathing and, if possible, try not to use heat producing appliances during the hottest part of the day.
	The temperature of the room you are trying to cool is extremely hot.	Allow additional time for the air conditioner to cool off a very hot room.

TROUBLESHOOTING TIPS (Continued)

Problem	Possible Cause	Possible Solution
Unit Does Not Cool/Heat Room Sufficiently, Or Cycles On And Off Too Frequently (continued).	The outside temperature is below 60° F (16° C).	Do not try to operate your air conditioner in the cooling mode when the outside temperature is below 60° F (16° C). The unit will not cool properly, and the unit may be damaged.
	The digital control is set to fan cycling mode.	Since the fan does not circulate the room air continuously at this setting, the room air does not mix as well and hot (or cold) spots may result. Using the continuous fan setting is recommended to obtain optimum comfort levels.
	The air conditioner has insufficient cooling capacity to match the heat gain of the room.	Check the cooling capacity of your unit to ensure it is properly sized for the room in which it is installed. Room air conditioners are not designed to cool multiple rooms.
	The air conditioner has insufficient heating capacity to match the heat loss of the room.	Check the heating capacity of your unit. Air conditioners are sized to meet the cooling load, and heater size is then selected to meet the heating load. In extreme northern climates, room air conditioners may not be able to be used as a primary source of heat.
Unit Runs Too Much.	This may be due to an excessive heat load in the room.	If there are heat producing appliances in use in the room, or if the room is heavily occupied, the unit will need to run longer to remove the additional heat.
	It may also be due to an improperly sized unit.	Be sure to use exhaust vent fans while cooking or bathing and, if possible, try not to use heat producing appliances during the hottest part of the day.
	This may be normal for higher efficiency (EER) air conditioners.	The use of higher efficiency components in your new air conditioner may result in the unit running longer than you feel it should. This may be more apparent, if it replaced an older, less efficient, model. The actual energy usage, however, will be significantly less when compared to older models.
	You may notice that the discharge air temperature of your new air conditioner may not seem as cold as you may be accustomed to from older units. This does not, however, indicate a reduction in the cooling capacity of the unit.	The energy efficiency ratio (EER) and cooling capacity rating (Btu/h) listed on the unit's rating plate are both agency certified.

COOLING ONLY ROOM AIR CONDITIONERS: TROUBLESHOOTING TIPS

Problem	Possible Cause	Possible Solution
Compressor does not run	Low voltage	Check voltage at compressor. 115V & 230V units will operate at 10% voltage variance
	Temperature not set cold enough or room air thermistor inoperative	Set temperature to lower than ambient position. Test thermistor and replace if inoperative.
	Compressor hums but cuts off on overload	Hard start compressor. Direct test compressor. If compressor starts, add starting components
	Open or shorted compressor windings	Check for continuity & resistance
	Open overload	Test overload protector & replace if inoperative
	Open capacitor	Test capacitor & replace if inoperative
	Inoperative system button	Test for continuity in all positions. Replace if inoperative switch or electronic board.
Broken, loose or incorrect wiring	Refer to appropriate wiring diagrams to check wiring. Correct as needed.	

Problem	Possible Cause	Possible Solution
Fan motor does not run	Inoperative system button	Test button & replace user interface if inoperative
	Broken, loose or incorrect wiring	Refer to applicable wiring diagram
	Open capacitor	Test capacitor & replace if inoperative
	Fan speed button defective	Replace user interface if inoperative
	Inoperative fan motor	Test fan motor & replace if inoperative (be sure internal overload has had time to reset)

Problem	Possible Cause	Possible Solution
Does not cool or only cools slightly	Undersized unit	Refer to industry standard sizing chart
	Indoor ambient thermistor open or shorted	See alarms and replace thermistor if needed.
	Dirty filter	Clean as recommended in Owner's Manual
	Dirty or restricted condenser or evaporator coil	Use pressure wash or biodegradable cleaning agent to clean
	Poor air circulation	Adjust discharge louvers. Use high fan speed
	Fresh air or exhaust air door open	Close doors. Instruct customer on use of this feature
	Low capacity - undercharge	Check for leak & make repair
	Compressor not pumping properly	Check amperage draw against nameplate. If not conclusive, make pressure test

COOLING ONLY ROOM AIR CONDITIONERS: TROUBLESHOOTING TIPS

Problem	Possible Cause	Possible Solution
Unit does not run	Fuse blown or circuit tripped	Replace fuse, reset breaker. If repeats, check fuse or breaker size. Check for shorts in unit wiring & components
	Power cord not plugged in	Plug it in
	System button in "OFF" position	Set correctly
	Inoperative system button or open electronic control board	Test for continuity. Check alarms. Correct as needed.
	Loose or disconnected wiring control board or other components	Check wiring & connections. Reconnect per wiring diagram

Problem	Possible Cause	Possible Solution
Evaporator coil freezes up	Dirty filter	Clean as recommended in Owner's Manual
	Restricted airflow	Check for dirty or obstructed coil. Use pressure wash or biodegradable cleaning agent to clean
	Inoperative thermistor	Check alarms. Replace as necessary.
	Short of refrigerant	De-ice coil & check for leak
	Inoperative fan motor	Test fan motor & replace if inoperative
	Partially restricted capillary tube	De-ice coil. Replace capillary tube.

Problem	Possible Cause	Possible Solution
Compressor runs continually & does not cycle off	Excessive heat load	Unit undersized. Test cooling performance & replace with larger unit if needed. See sizing chart.
	Restriction in line	Check for partially iced coil & check temperature split across coil
	Refrigerant leak	Find leak and repair.
	Compressor relay contacts stuck	Check operation of t-stat. Replace if contacts remain closed.
	Remote wall T-stat incorrectly wired	Refer to appropriate wiring diagram
	Thermistor shorted	Replace thermistor or electronic control board

Problem	Possible Cause	Possible Solution
Electronic control board does not turn unit off	Compressor relay contacts stuck	Replace electronic control board
	Temperature set at coldest point	Turn to higher temp. setting to see if unit cycles off. If not, replace control board.
	Incorrect wiring	Refer to appropriate wiring diagrams
	Unit undersized for area to be cooled	Refer to industry standard sizing chart
	Defective thermistor	Replace thermistor or electronic control board

COOLING ONLY ROOM AIR CONDITIONERS: TROUBLESHOOTING TIPS

Problem	Possible Cause	Possible Solution
Compressor runs for short periods only. Cycles on overload	Overload inoperative. Opens too soon	Check operation of unit. Replace overload if system operation is satisfactory
	Compressor restarted before system pressures equalized	Control's default of 3 minutes wait delay timer inoperative. Replace board.
	Low or fluctuating voltage	Check voltage with unit operating. Check for other appliances on circuit. Air conditioner should be in a dedicated circuit for proper voltage & fused separately
	Incorrect wiring	Refer to appropriate wiring diagram
	Shorted or incorrect capacitor	Test capacitor and replace if needed.
	Restricted or low air flow through condenser coil or evaporator coil	Check for proper fan speed or blocked coils. Correct as needed.
	Compressor running abnormally hot	Check for kinked discharge line or restricted condenser. Refrigerant overcharge. Check amperage, connections.

Problem	Possible Cause	Possible Solution
Unit does not turn on	No power	Check power supply. Check LCDI plug. Check wire connections. Check if panel is locked.
	Incorrect wiring	Refer to appropriate wiring diagram
	Defective thermistor	Replace thermistor or electronic control board

Problem	Possible Cause	Possible Solution
Noisy operation	Poorly installed	Refer to Installation Manual for proper installation
	Fan blade striking chassis	Reposition - adjust motor mount
	Compressor vibrating	Check that compressor grommets have not deteriorated. Check that compressor mounting parts are not missing
	Improperly mounted or loose cabinet parts refrigerant tubes	Check assembly & parts for looseness, rubbing & rattling pipes, etc.

Problem	Possible Cause	Possible Solution
Water leaks into the room	Evaporator drain pan overflowing	Clean obstructed drain trough
	Condensation forming underneath base pan	Evaporator drain pan broken or cracked. Reseal or replace. No chassis gasket installed. Install chassis gasket
	Poor installation resulting in rain entering the room	Check installation instructions. Reseal as required
	Condensation on discharge grille louvers	Dirty evaporator coil. Use pressure wash or biodegradable cleaning agent to clean. Environmental phenomena: point supply louvers upward. Put on high fan.
	Chassis gasket not installed	Install gasket, per Installation manual
	Downward slope of unit is too steep inward	Refer to installation manual for proper installation

COOLING ONLY ROOM AIR CONDITIONERS: TROUBLESHOOTING TIPS

Problem	Possible Cause	Possible Solution
Water "spitting" into room	Sublimation: When unconditioned saturated, outside air mixes with conditioned air, condensation forms on the cooler surfaces	Ensure that foam gaskets are installed in between window panes & in between the unit & the sleeve. Also, ensure that fresh air/exhaust vents (on applicable models) are in the closed position & are in tact
	Downward pitch of installation is too steep towards back of unit	Follow installation instructions to ensure that downward pitch of installed unit is no less than 1/4" & no more than 3/8"
	Restricted coil or dirty filter	Clean & advise customer of periodic cleaning & maintenance needs of entire unit

Problem	Possible Cause	Possible Solution
Excessive moisture	Insufficient air circulation thru area to be air conditioned	Adjust louvers for best possible air circulation
	Oversized unit	Operate in "MoneySaver" position
	Inadequate vapor barrier in building structure, particularly floors	Advise customer

Problem	Possible Cause	Possible Solution
Unit short cycles	Defective thermistor	Replace thermistor or electronic control board
	Unit oversized	See sizing chart. Correct as needed.
	Chassis seal gasket not sealing or absent causing unit to short cycle	Check gasket. Reposition or replace as needed
	Restricted coil or dirty filter	Clean & advise customer of periodic cleaning & maintenance needs of entire unit

Problem	Possible Cause	Possible Solution
Prolonged off cycles	Defective indoor ambient thermistor or electronic control board	Check alarms. Replace thermistor or electronic control board
	Defective remote wall t-stat	Replace t-stat

Problem	Possible Cause	Possible Solution
Outside water leaks	Evaporator drain pan cracked or obstructed	Repair, clean or replace as required
	Water in compressor area	Detach shroud from pan & coil. Clean & remove old sealer. Reseal, reinstall & check
	Obstructed condenser coil	Use pressure wash or biodegradable cleaning agent to clean
	Fan blade/slinger ring improperly positioned	Adjust fan blade to 1/2" of condenser coil fin pack

HEAT / COOL ONLY ROOM AIR CONDITIONERS: TROUBLESHOOTING TIPS

Problem	Possible Cause	Possible Solution
Room temperature uneven (Heating cycle)	Bad indoor ambient thermistor	Check error codes. Replace as needed.
	Fan speed too low	Set at higher fan speed.
	Opened door, windows, etc.	Close doors, windows, etc.
	ATSF (room air sampling feature) disabled	Enable ATSF

Problem	Possible Cause	Possible Solution
Unit will not defrost (Heat pump only models)	Bad outdoor coil thermistor	Replace thermistor.
	Temperature below 32°F/ 0°C	<ul style="list-style-type: none"> • On heat pumps with electric heat: no action needed • On model YSM10: do not operate below 32°F/ 0°C • If outdoor air temp is higher than freezing, check reversing valve, electric coil, outdoor thermistor, refrigerant circuits, etc. • For proper operation: correct as needed

Problem	Possible Cause	Possible Solution
Does not heat adequately	Exhaust or fresh air door open	Check if operating properly. Instruct customer on proper use of control
	Dirty filter	Clean as recommended in Owner's Manual
	Unit undersized	Check heat rise across coil. If unit operates efficiently, check if insulation can be added to attic or walls. If insulation is adequate, recommend additional unit or larger one
	Outdoor coil thermistor or electronic control board defective	Check alarms (error codes). Replace thermistor or electronic control board.
	Heater hi-limit control cycling on & off	Check for adequate fan air across heater. Check for open hi-limit control.
	Shorted or open supplementary heater	Do ohmmeter check.
	Incorrect wiring	Check applicable wiring diagram

HEAT PUMP ROOM AIR CONDITIONERS: TROUBLE SHOOTING TIPS

Problem	Possible Cause	Action
Unit cools when heat is called for	Incorrect wiring	Refer to applicable wiring diagram
	Defective solenoid coil	Check for continuity of coil
	Reversing valve fails to shift	Block condenser coil & switch unit to cooling. Allow pressure to build up in system, then switch to heating. If valve fails to shift, replace valve.
	Inoperative system switch	Check for continuity of system switch

Problem	Possible Cause	Action
Cooling adequate, but heating insufficient	Heating capillary tube partially restricted	Check for partially starved outer coil. Replace heating capillary tube
	Check valve leaking internally	Switch unit several times from heating to cooling. Check temperature rise across coil. Refer to specification sheet for correct temperature rise
	Reversing valve failing to shift completely; bypassing hot gas	Denergize solenoid coil, raise head pressure, energize solenoid to break loose. If valve fails to make complete shift, replace valve.

TROUBLESHOOTING CHART - HEAT PUMP

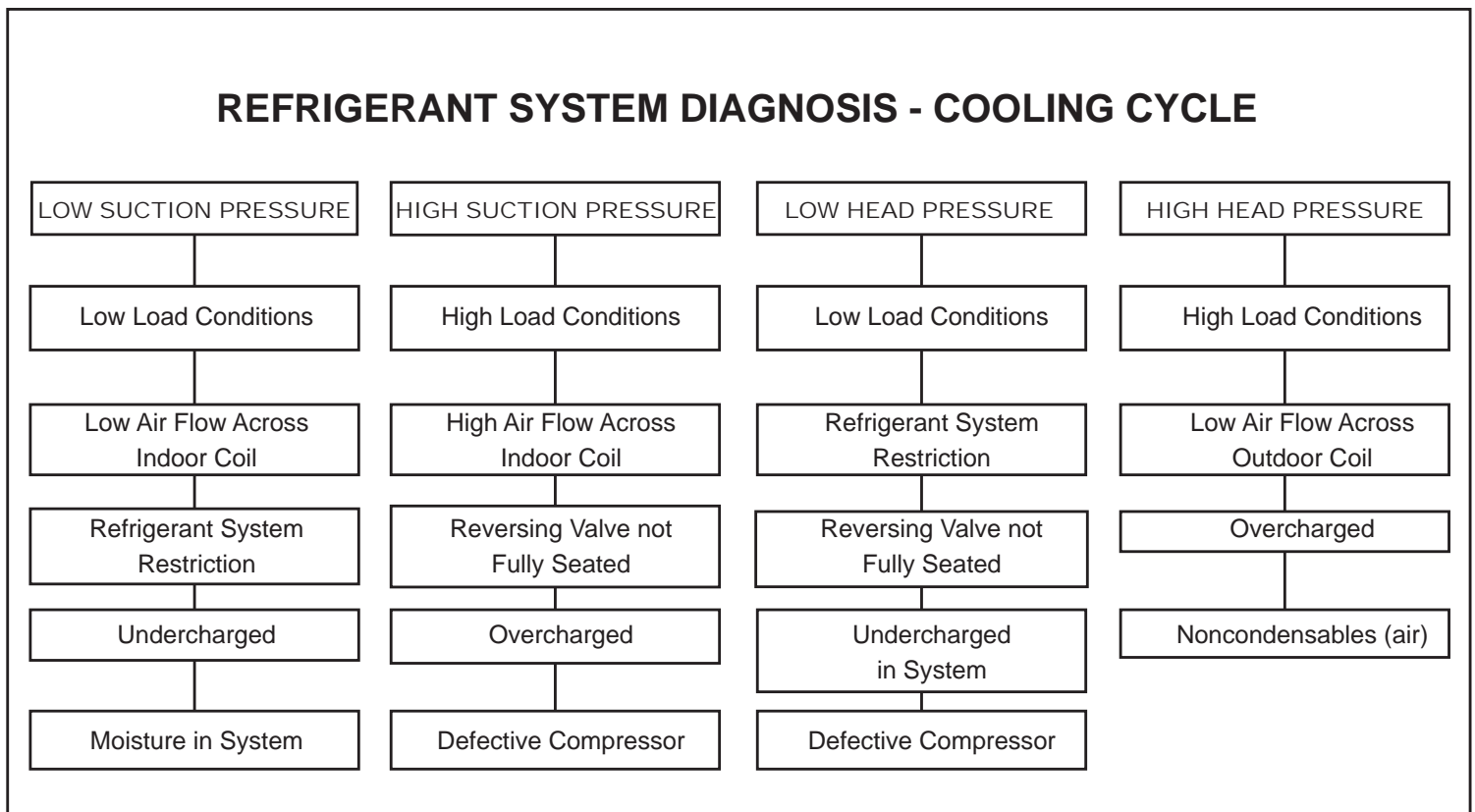

HEAT PUMP ROOM AIR CONDITIONERS: TROUBLE SHOOTING TIPS

REFRIGERANT SYSTEM DIAGNOSIS - HEATING CYCLE

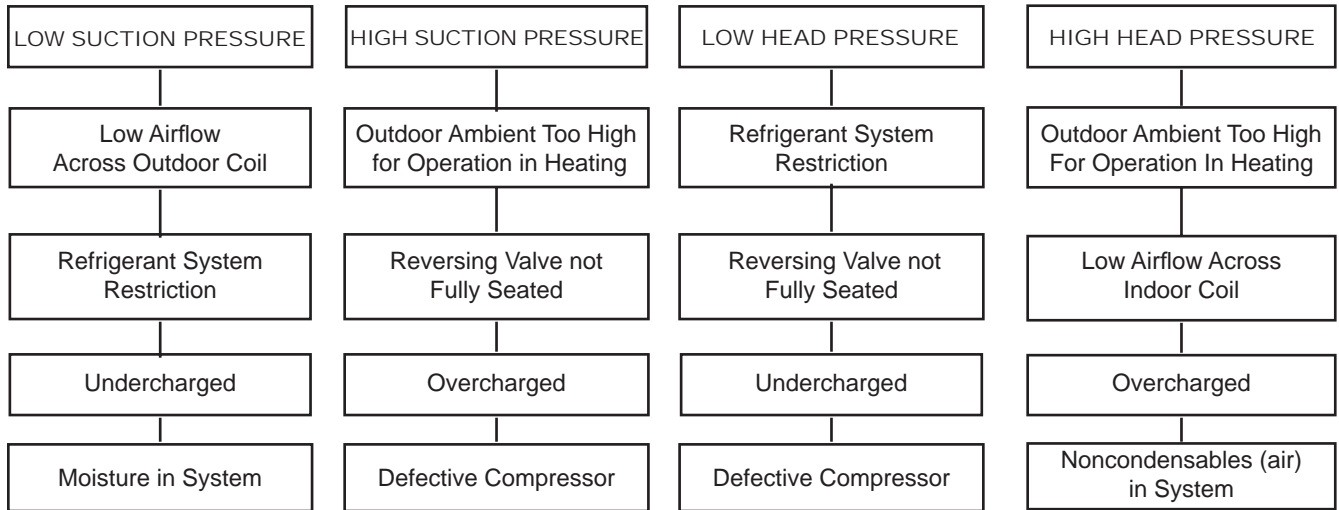

ELECTRICAL TROUBLESHOOTING CHART - HEAT PUMP

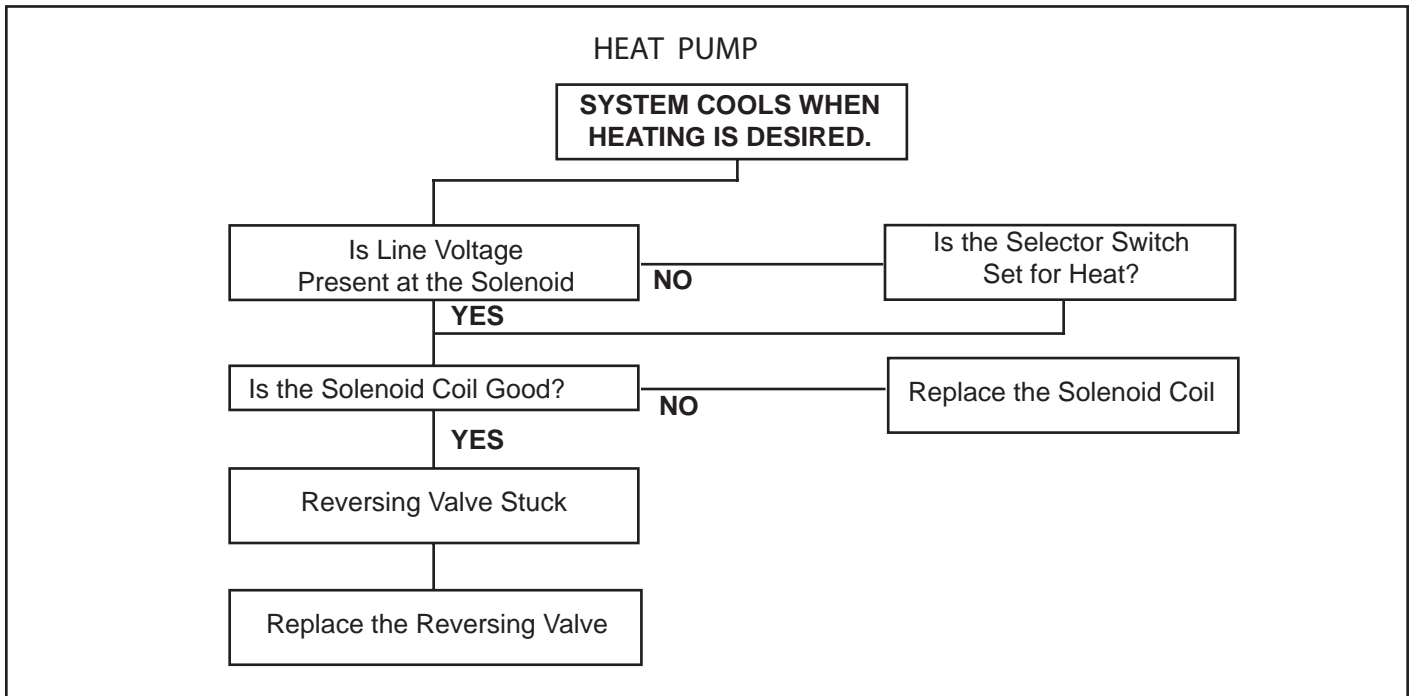

TROUBLESHOOTING TOUCH TEST CHART: TO SERVICE REVERSING VALVES

NORMAL FUNCTION OF VALVE								
VALVE OPERATING CONDITION	DISCHARGE TUBE from Compressor	SUCTION TUBE to Compressor	Tube to INSIDE COIL	Tube to OUTSIDE COIL	LEFT Pilot Capillary Tube	RIGHT Pilot Capillary Tube	NOTES:	
	1	2	3	4	5	6	* TEMPERATURE OF VALVE BODY ** WARMER THAN VALVE BODY	
							POSSIBLE CAUSES	CORRECTIONS
Normal Cooling	Hot	Cool	Cool as (2)	Hot as (1)	*TVB	TVB		
Normal Heating	Hot	Cool	Hot as (1)	Cool as (2)	*TVB	TVB		
MALFUNCTION OF VALVE								
Valve will not shift from cool to heat.	Check Electrical circuit and coil						No voltage to coil.	Repair electrical circuit.
							Defective coil.	Replace coil.
	Check refrigeration charge						Low charge.	Repair leak, recharge system.
							Pressure differential too high.	Recheck system.
	Hot	Cool	Cool, as (2)	Hot, as (1)	*TVB	Hot	Pilot valve okay. Dirt in one bleeder hole.	Deenergize solenoid, raise head pressure, reenergize solenoid to break dirt loose. If unsuccessful, remove valve, wash out. Check on air before installing. If no movement, replace valve, add strainer to discharge tube, mount valve horizontally.
						Piston cup leak	Stop unit. After pressures equalize, restart with solenoid energized. If valve shifts, reattempt with compressor running. If still no shift, replace valve.	
Valve will not shift from cool to heat.	Hot	Cool	Cool, as (2)	Hot, as (1)	*TVB	*TVB	Clogged pilot tubes.	Raise head pressure, operate solenoid to free. If still no shift, replace valve.
	Hot	Cool	Cool, as (2)	Hot, as (1)	Hot	Hot	Both ports of pilot open. (Back seat port did not close).	Raise head pressure, operate solenoid to free partially clogged port. If still no shift, replace valve.
	Warm	Cool	Cool, as (2)	Hot, as (1)	*TVB	Warm	Defective Compressor.	Replace compressor
Starts to shift but does not complete reversal.	Hot	Warm	Warm	Hot	*TVB	Hot	Not enough pressure differential at start of stroke or not enough flow to maintain pressure differential.	Check unit for correct operating pressures and charge. Raise head pressure. If no shift, use valve with smaller port.
							Body damage.	Replace valve
	Hot	Warm	Warm	Hot	Hot	Hot	Both ports of pilot open.	Raise head pressure, operate solenoid. If no shift, use valve with smaller ports.
	Hot	Hot	Hot	Hot	*TVB	Hot	Body damage.	Replace valve
							Valve hung up at mid-stroke. Pumping volume of compressor not sufficient to maintain reversal.	Raise head pressure, operate solenoid. If no shift, use valve with smaller ports.
Hot	Hot	Hot	Hot	Hot	Hot	Both ports of pilot open.	Raise head pressure, operate solenoid. If no shift, replace valve.	
Apparent leap in heating.	Hot	Cool	Hot, as (1)	Cool, as (2)	*TVB	*TVB	Piston needle on end of slide leaking.	Operate valve several times, then recheck. If excessive leak, replace valve.
	Hot	Cool	Hot, as (1)	Cool, as (2)	**WVB	**WVB	Pilot needle and piston needle leaking.	Operate valve several times, then recheck. If excessive leak, replace valve.
Will not shift from heat to cool.	Hot	Cool	Hot, as (1)	Cool, as (2)	*TVB	*TVB	Pressure differential too high.	Stop unit. Will reverse during equalization period. Recheck system
							Clogged pilot tube.	Raise head pressure, operate solenoid to free dirt. If still no shift, replace valve.
	Hot	Cool	Hot, as (1)	Cool, as (2)	Hot	*TVB	Dirt in bleeder hole.	Raise head pressure, operate solenoid. Remove valve and wash out. Check on air before reinstalling, if no movement, replace valve. Add strainer to discharge tube. Mount valve horizontally.
	Hot	Cool	Hot, as (1)	Cool, as (2)	Hot	*TVB	Piston cup leak.	Stop unit. After pressures equalize, restart with solenoid deenergized. If valve shifts, reattempt with compressor running. If it still will not reverse while running, replace the valve.
	Hot	Cool	Hot, as (1)	Cool, as (2)	Hot	Hot	Defective pilot.	Replace valve.
	Warm	Cool	Warm, as (1)	Cool, as (2)	Warm	*TVB	Defective compressor.	Replace compressor

ELECTRONIC CONTROL BOARD COMPONENTS IDENTIFICATION

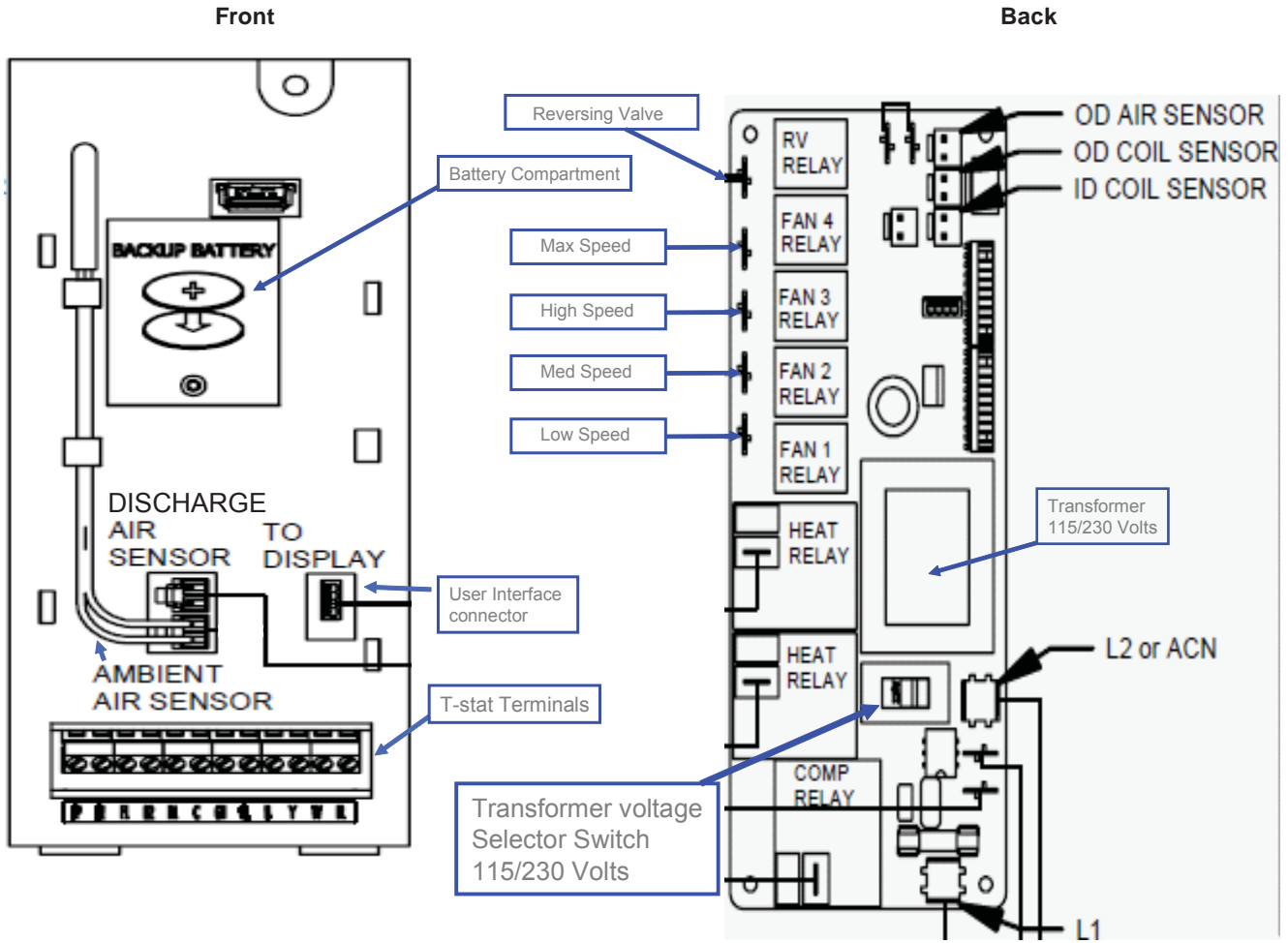

Sample board for Kuhl+ unit

REMOTE WALL THERMOSTAT WIRING DIAGRAMS

LEGEND FOR T-STAT WIRING HARNESS

C	Common Terminal
GH	Call for High Fan
GL	Call for Low Fan
B	Reversing Valve
Y	Coil for Cooling
W	Call for Heat
R	24 VAC Power From Unit
RT5 - Two Speeds Fan T-Stat - Field Provided	
- - - - Field Wiring	

COOL W/O ELECTRIC HEAT

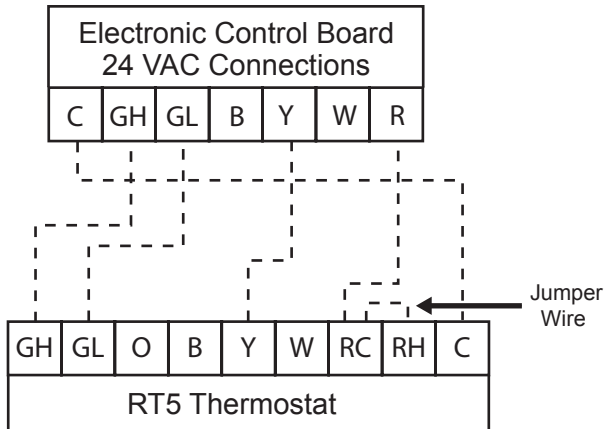

COOL WITH ELECTRIC HEAT

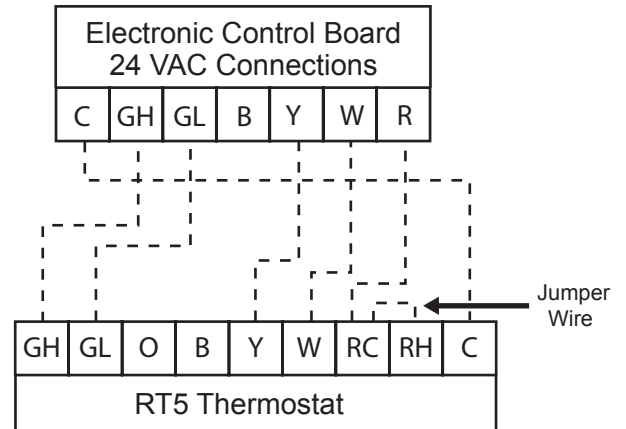

HEAT PUMP ONLY AND HEAT PUMP WITH ELECTRIC HEAT

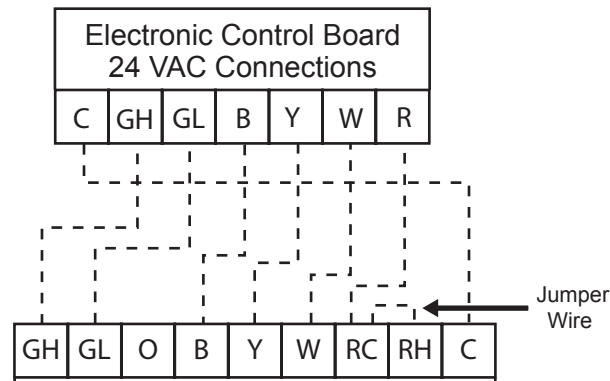

KUHL
ELECTRONIC CONTROL
COOL ONLY MODELS
 SS08M10A, SS10M10A, SS12M10A, SS14M10A
 SS12M30A, SS15M30A
 SM18M30A, SM21M30A, SM24M30A

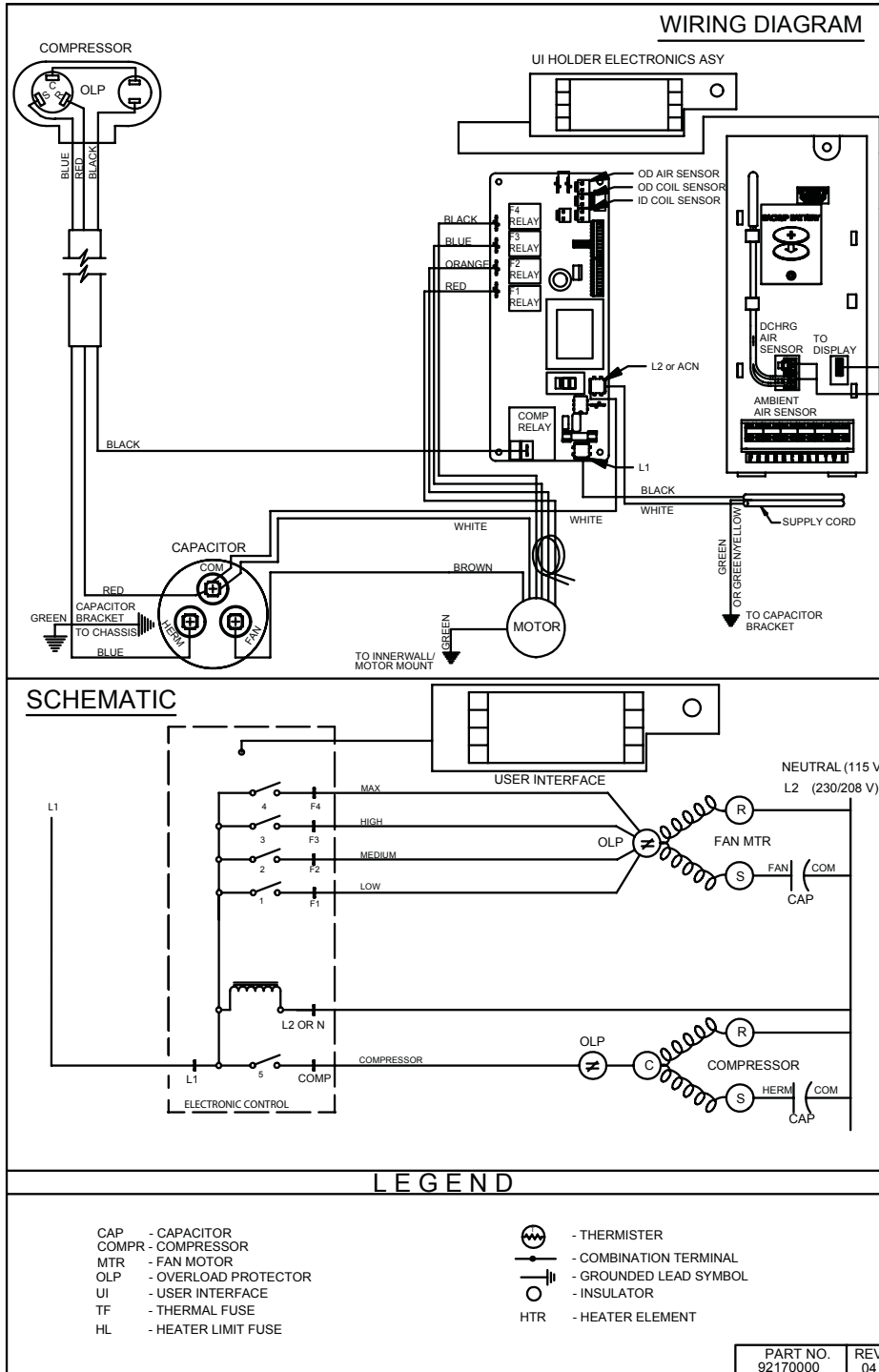

KUHL ELECTRONIC CONTROL COOL ONLY MODELS SL28M30A, SL36M30A

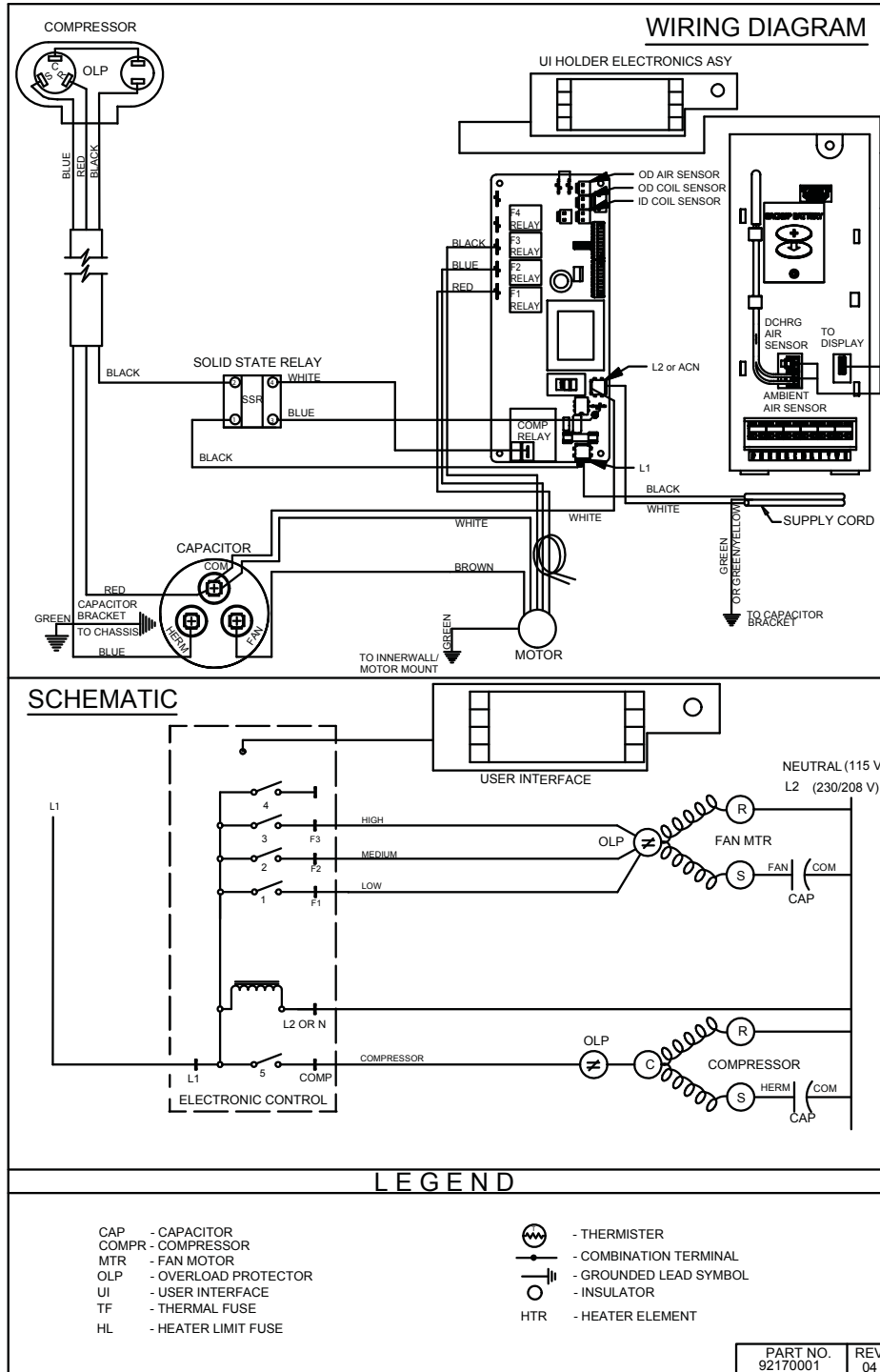

KUH+ ELECTRONIC CONTROL COOL WITH ELECTRIC HEAT MODELS ES12M33A, ES15M33A EM18M34A, EM24M34A

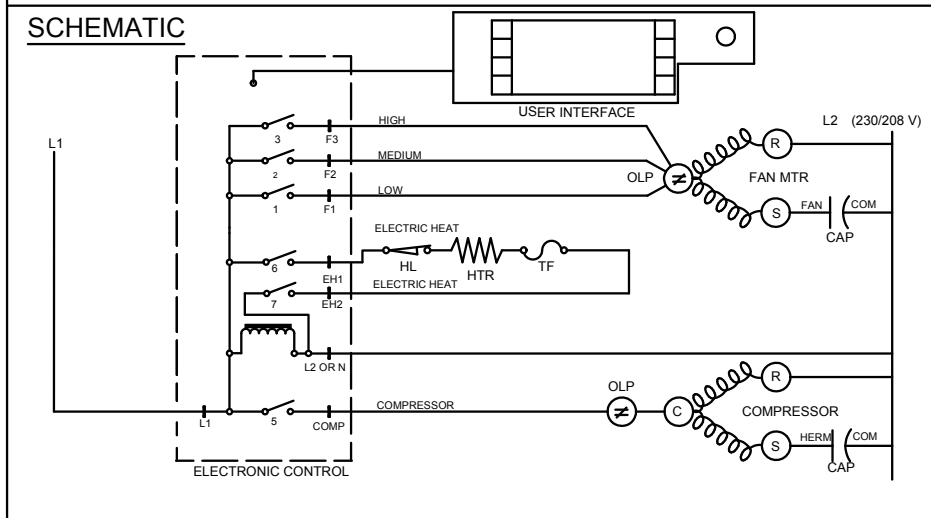
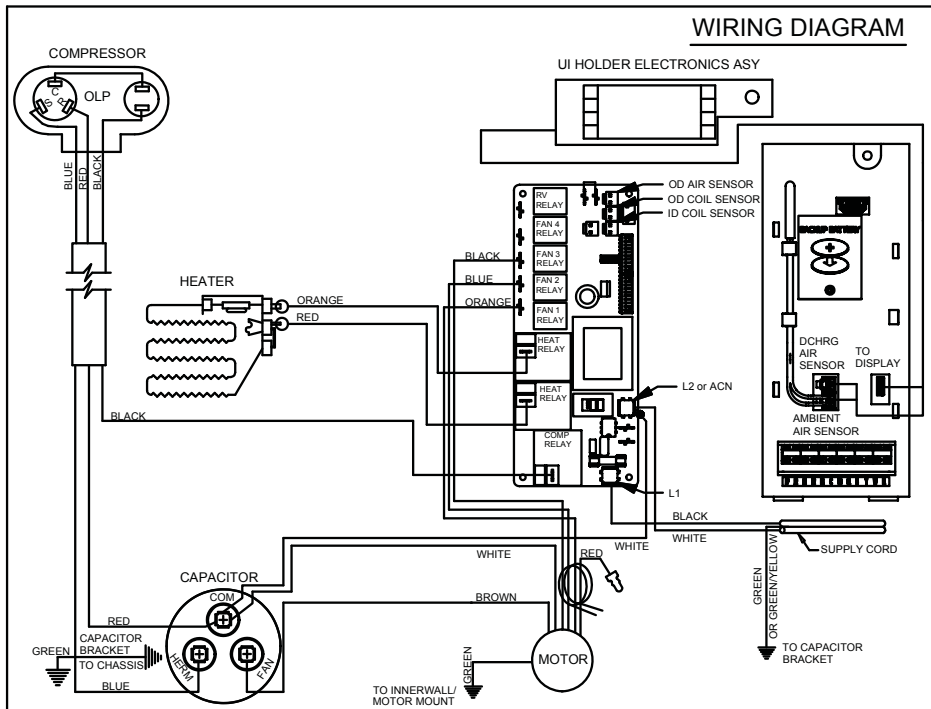

LEGEND

<p>CAP - CAPACITOR COMPR - COMPRESSOR MTR - FAN MOTOR OLP - OVERLOAD PROTECTOR UI - USER INTERFACE TF - THERMAL FUSE HL - HEATER LIMIT FUSE</p>	<p> - THERMISTOR - COMBINATION TERMINAL - GROUNDED LEAD SYMBOL - INSULATOR - HEATER ELEMENT</p>
---	---

PART NO. 92170002	REV. 04
----------------------	------------

KUHL+ ELECTRONIC CONTROL COOL WITH ELECTRIC HEAT MODEL EL36M35A

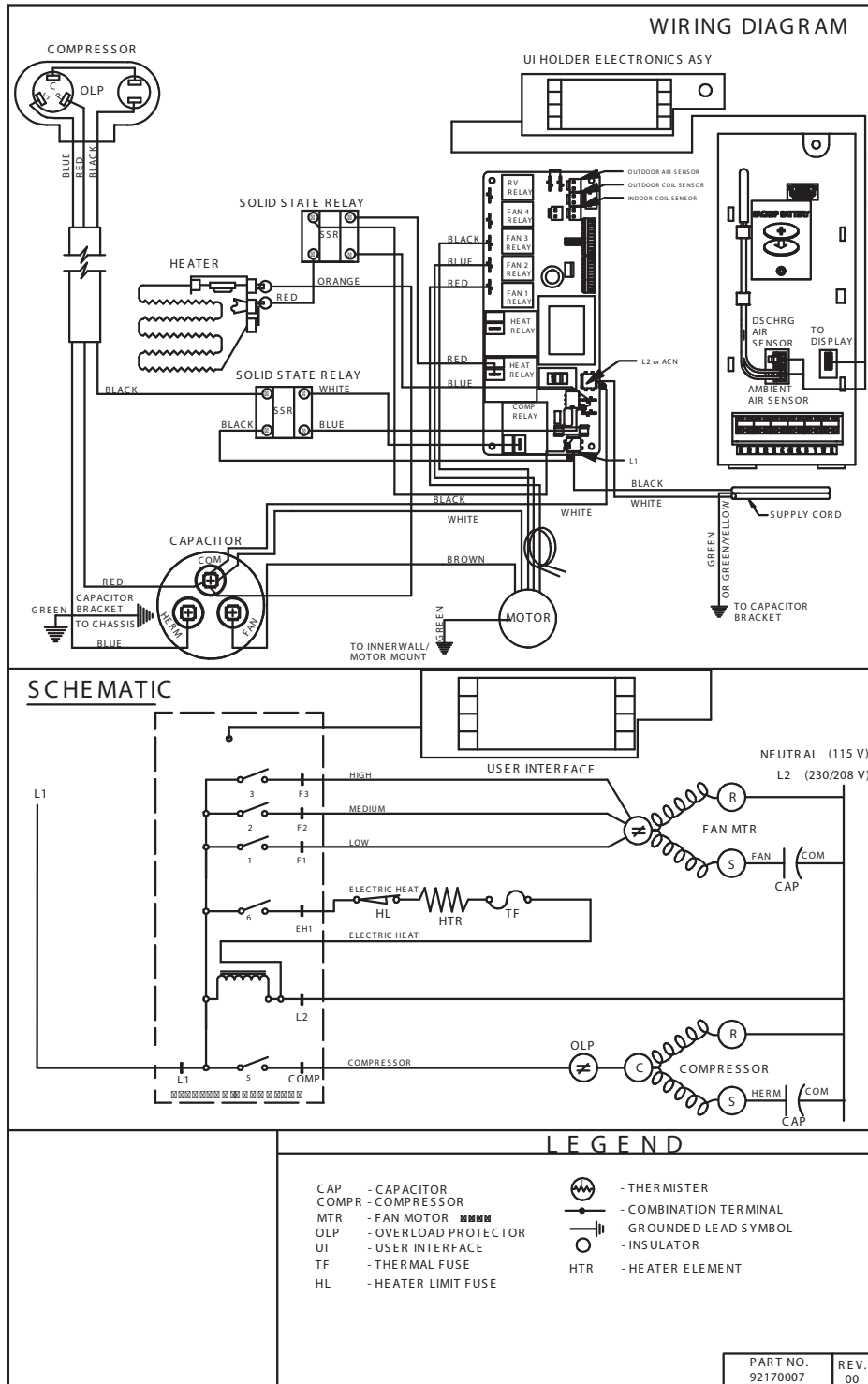

KUHL+ ELECTRONIC CONTROL HEAT PUMP ONLY MODEL YS10M10A

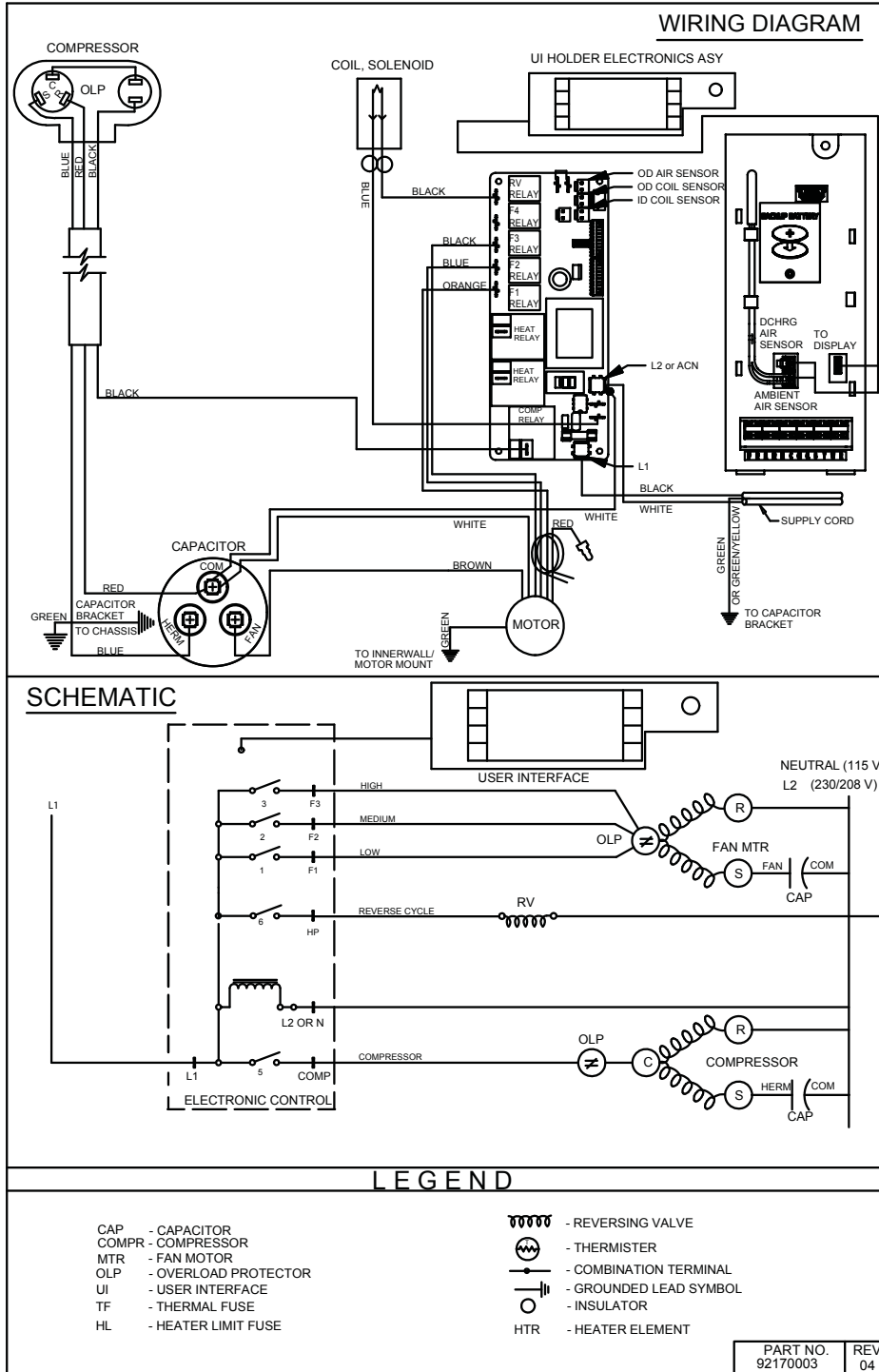

KUHL+ ELECTRONIC CONTROL HEAT PUMP WITH ELECTRIC HEAT MODELS YS12M33A, YM18M34A

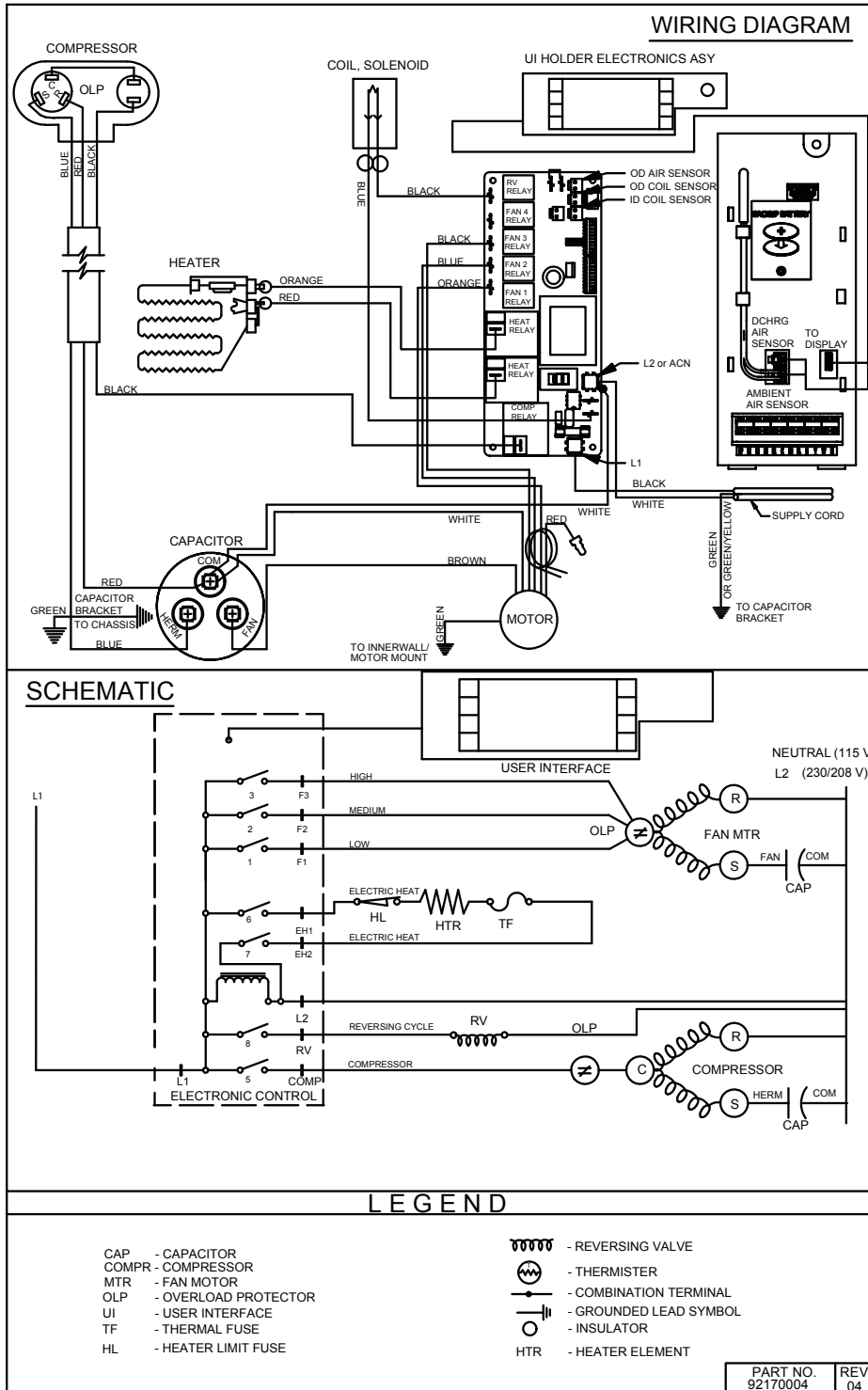

KUHL+ ELECTRONIC CONTROL HEAT PUMP WITH ELECTRIC HEAT MODEL YL24M35A

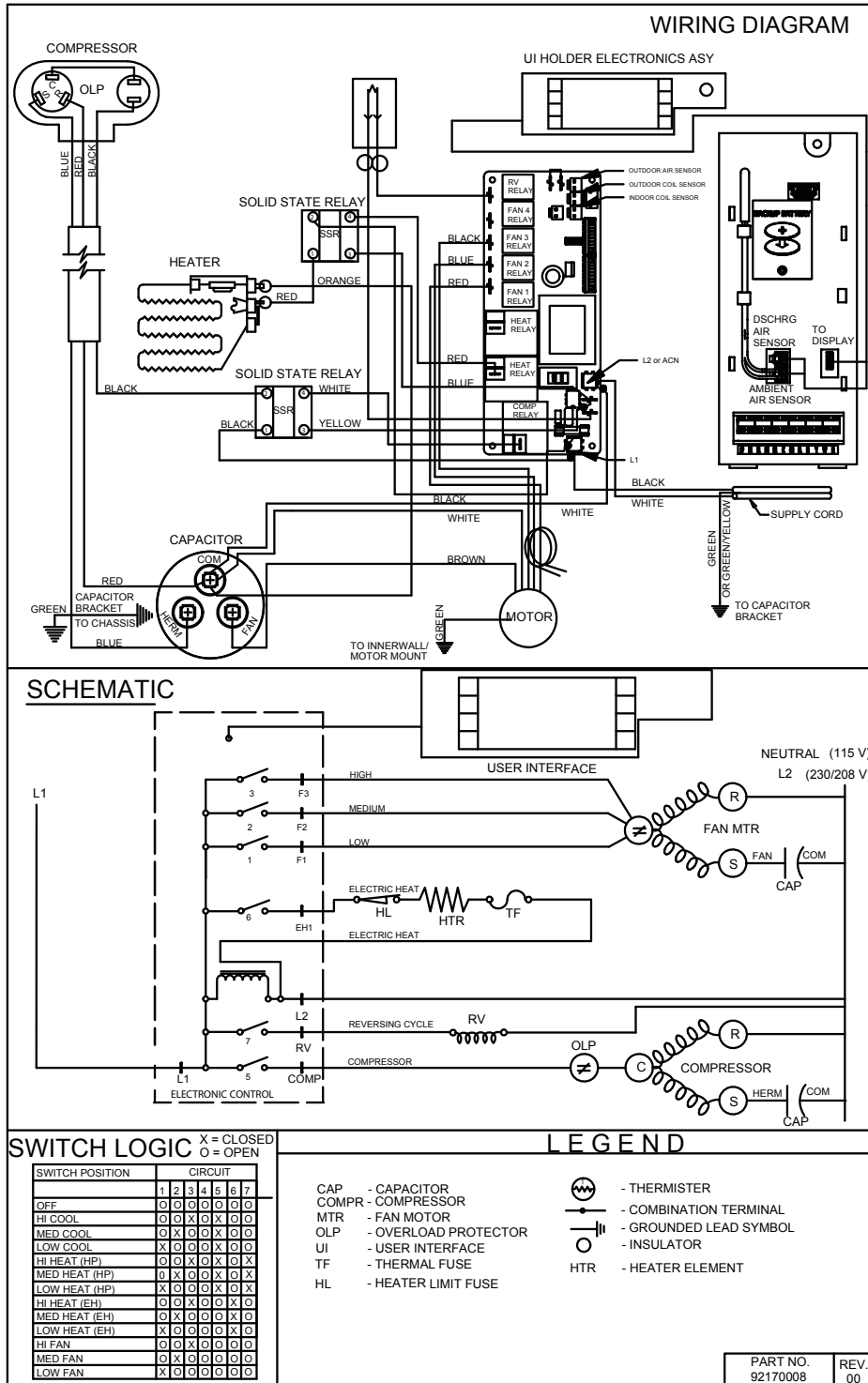

THERMISTORS' RESISTANCE VALUES (This Table Applies to All Thermistors)

TEMP F	INDOOR AIR SENSOR RESISTANCE (K Ohms)			RESISTANCE TOLERANCE %	
	MIN	CENTR	MAX	MIN	MAX
-25	210.889	225.548	240.224	6.50	6.51
-20	178.952	190.889	202.825	6.25	6.25
-15	151.591	161.325	171.059	6.03	6.03
-10	128.434	136.363	144.292	5.81	5.81
-5	108.886	115.340	121.794	5.60	5.60
0	92.411	97.662	102.912	5.38	5.38
5	78.541	82.812	87.083	5.16	5.16
10	66.866	70.339	73.812	4.94	4.94
15	57.039	59.864	62.688	4.72	4.72
20	48.763	51.060	53.357	4.50	4.50
25	41.786	43.654	45.523	4.28	4.28
30	35.896	37.415	38.934	4.06	4.06
31	34.832	36.290	37.747	4.02	4.02
32	33.803	35.202	36.601	3.97	3.97
33	32.808	34.150	35.492	3.93	3.93
34	31.846	33.133	34.421	3.89	3.89
35	30.916	32.151	33.386	3.84	3.84
36	30.016	31.200	32.385	3.80	3.80
37	29.144	30.281	31.418	3.75	3.75
38	28.319	29.425	30.534	3.76	3.77
39	27.486	28.532	29.579	3.67	3.67
40	26.697	27.701	28.704	3.62	3.62
45	23.116	23.931	24.745	3.40	3.40
50	20.071	20.731	21.391	3.18	3.18
55	17.474	18.008	18.542	2.96	2.96
60	15.253	15.684	16.115	2.75	2.75
65	13.351	13.697	14.043	2.53	2.53
66	13.004	13.335	13.666	2.48	2.48
67	12.668	12.984	13.301	2.44	2.44
68	12.341	12.644	12.947	2.39	2.39
69	12.024	12.313	12.603	2.35	2.35
70	11.716	11.993	12.269	2.31	2.31
71	11.418	11.682	11.946	2.26	2.26
72	11.128	11.380	11.633	2.22	2.22
73	10.846	11.088	11.329	2.18	2.18
74	10.574	10.804	11.034	2.13	2.13
75	10.308	10.528	10.748	2.09	2.09
76	10.051	10.260	10.469	2.04	2.04
77	9.800	10.000	10.200	2.00	2.00
78	9.550	9.748	9.945	2.03	2.03
79	9.306	9.503	9.699	2.07	2.07
80	9.070	9.265	9.459	2.10	2.10
81	8.841	9.033	9.226	2.13	2.13
82	8.618	8.809	9.000	2.17	2.17
83	8.402	8.591	8.780	2.20	2.20
84	8.192	8.379	8.566	2.23	2.23
85	7.987	8.172	8.358	2.27	2.27
86	7.789	7.972	8.155	2.30	2.30
87	7.596	7.778	7.959	2.33	2.33
88	7.409	7.589	7.768	2.37	2.37
89	7.227	7.405	7.583	2.40	2.40
90	7.050	7.226	7.402	2.43	2.43
91	6.878	7.052	7.226	2.47	2.47
92	6.711	6.883	7.055	2.50	2.50
93	6.548	6.718	6.889	2.53	2.53
94	6.390	6.558	6.727	2.57	2.57
95	6.237	6.403	6.569	2.60	2.60
96	6.087	6.252	6.417	2.63	2.63
97	5.942	6.105	6.268	2.67	2.67
98	5.800	5.961	6.122	2.70	2.70
99	5.663	5.822	5.981	2.73	2.73
100	5.529	5.686	5.844	2.77	2.77
105	4.912	5.060	5.208	2.93	2.93
110	4.371	4.511	4.651	3.10	3.10
115	3.898	4.030	4.161	3.27	3.27
120	3.482	3.606	3.730	3.43	3.43



Replacement Remote Control Configuration Instructions

For Use with Kühl (cool only models) and Kühl + (cool & heat models)

Contents:

- Remote Control with Holder
- (2) AAA-batteries
- Instruction Sheet

ATTENTION! – You May Need to Configure The Replacement Remote Control
Please read instructions completely before attempting configuration of the Remote Control. Failure to do so could result in the Remote Control not being able to operate the Air Conditioning Unit properly.

- Step 1.** **A. Locate the Model # of your Air Conditioner.**
B. Identify the prefix (First 2 Letters) of your unit’s model #.
C. Look at the chart below and in it, find the prefix of your AC unit’s model #.
D. Note the Option # Code (OPT#) next to it and the required action. The unit’s display is supposed to show this OPT# Code.

Model Prefix	Option Code	Required Action
SS, SM	OPT 1	None – Remote Control configured for use with air conditioner
SL	OPT 2	Perform Steps 2 - 5
YS, YM, YL, ES, EM, EL	OPT 3	Perform Steps 2 - 5

Step 2. Point the Remote Control at Air Conditioning Unit and then press the Remote Control’s **POWER** Key once to illuminate the Air Conditioning Unit’s display.

Step 3. Once the display on the Air Conditioning Unit is illuminated, check the **Option Code number (OPT#)** shown in the display and ensure it matches the OPT# code for your unit as per the chart above.

Air Conditioner Unit’s Display (see example below Fig 1)

OPT1

OPT2

OPT3 Displayed example



Figure 1



Step 4 Checking the Remote Control's OPT # Code

With the Remote Control's display illuminated, **press and hold** the Remote Control's **SCHEDULE** and the **FAN SPEED** Keys simultaneously for approximately 6 seconds until the Remote Control displays its current **OPT# Code**.

If the OPT# Code is different than the AC Unit's OPT# Code see instructions below:

Remote Control

Remote Control's OPT# Code (see example below Fig 2)

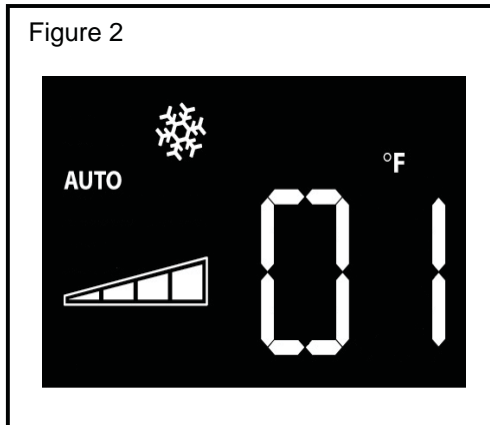

Using the Remote Control's **▲ Increase** or **▼ Decrease** Keys, change the **OPT# Code** displayed on the Remote Control to match the **OPT # Code** shown on the **Air Conditioning Unit's display** (see examples below).

Air Conditioning Unit Display

Remote Control Display

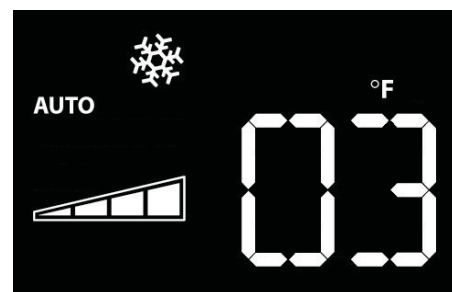

Step 5. To save the setting in the Remote Control, press and hold the Remote Control **SCHEDULE** and **FAN SPEED** Key simultaneously for approximately 6 seconds until the displayed configuration number on the Remote Control flashes.

The Remote Control is now configured to work with the air conditioner.



Replacement Instructions

For Use with Kühl (cool only models) and Kühl + (cool and heat models)

ATTENTION! - Please read these instructions completely before attempting replacement. Always unplug the power supply from the power supply receptacle.

Contents:

- User Interface (UI)
- Ribbon Cable
- 2 – Mounting screws for UI
- Instruction Sheet

Step 1. Disconnect ribbon cable by pulling straight out

Step 2. Remove 2 –mounting screws securing UI and disconnect ribbon cable

Step 3. Remove UI and ribbon cable from handle assembly

Step 4. Install new UI using the 2-screws, route new ribbon cable and reattach ribbon cable to UI and Main control board

Step 5. Verify control operation

Ribbon cable connection

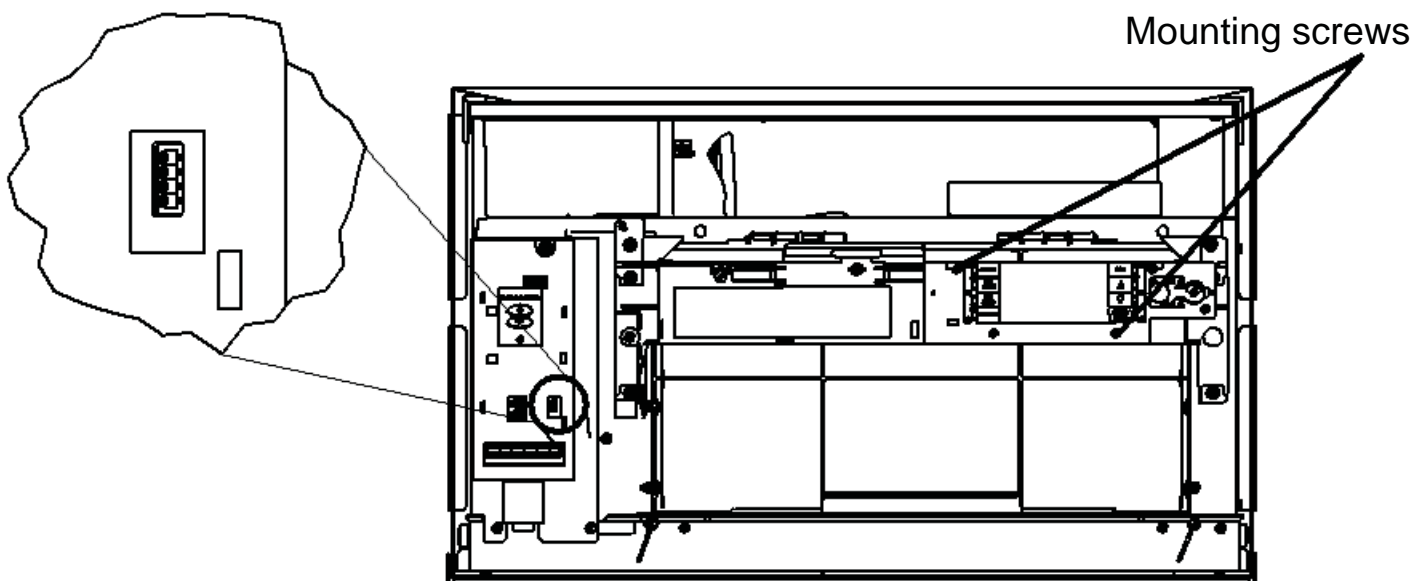

INSTRUCTIONS FOR USING COOLING LOAD ESTIMATE FORM FOR ROOM AIR CONDITIONERS (AHAM PUB. NO. RAC-1)

- A. This cooling load estimate form is suitable for estimating the cooling load for comfort air conditioning installations which do not require specific conditions of inside temperature and humidity.
- B. The form is based on an outside design temperature of 95°F dry bulb and 75°F wet bulb. It can be used for areas in the continental United States having other outside design temperatures by applying a correction factor for the particular locality as determined from the map.
- C. The form includes “day” factors for calculating cooling loads in rooms where daytime comfort is desired (such as living rooms, offices, etc.)
- D. The numbers of the following paragraphs refer to the corresponding numbered item on the form:
 - 1. Multiply the square feet of window area for each exposure by the applicable factor. The window area is the area of the wall opening in which the window is installed. For windows shaded by inside shades or venetian blinds, use the factor for “Inside Shades.” For windows shaded by outside awnings or by both outside awnings and inside shades (or venetian blinds), use the factor for “Outside Awnings.” “Single Glass” includes all types of single thickness windows, and “Double Glass” includes sealed airspace types, storm windows, and glass block. Only one number should be entered in the right hand column for Item 1, and this number should represent **only the exposure with the largest load.**
 - 2. Multiply the total square feet of **all** windows in the room by the applicable factor.
 - 3a. Multiply the total length (linear feet) of all walls exposed to the outside by the applicable factor. Doors should be considered as being part of the wall. Outside walls facing due north should be calculated separately from outside walls facing other directions. Walls which are permanently shaded by adjacent structures should be considered “North Exposure.” Do not consider trees and shrubbery as providing permanent shading. An uninsulated frame wall or a masonry wall 8 inches or less in thickness is considered “Light Construction.” An insulated wall or masonry wall over 8 inches in thickness is considered “Heavy Construction.”
 - 3b. Multiply the total length (linear feet) of all inside walls between the space to be conditioned and any unconditioned spaces by the given factor. Do not include inside walls which separate other air conditioned rooms.
 - 4. Multiply the total square feet of roof or ceiling area by the factor given for the type of construction most nearly describing the particular application (use one line only.)
 - 5. Multiply the total square feet of floor area by the factor given. Disregard this item if the floor is directly on the ground or over a basement.
 - 6. Multiply the number of people who normally occupy the space to be air conditioned by the factor given. Use a minimum of 2 people.
 - 7. Determine the total number of watts for light and electrical equipment, except the air conditioner itself, that will be **in use** when the room air conditioning is operating. Multiply the total wattage by the factor given.
 - 8. Multiply the total width (linear feet) of any doors or arches which are continually open to an unconditioned space by the applicable factor.

NOTE: Where the width of the doors or arches is more than 5 feet, the actual load may exceed the calculated value. In such cases, both adjoining rooms should be considered as a single large room, and the room air conditioner unit or units should be selected according to a calculation made on this new basis.
 - 9. Total the loads estimated for the foregoing 8 items.
 - 10. Multiply the subtotal obtained in item 9 by the proper correction factor, selected from the map, for the particular locality. The result is the total estimated design cooling load in BTU per hour.
- E. For best results, a room air conditioner unit or units having a cooling capacity rating (determined in accordance with the NEMA Standards Publication for Room Air Conditioners, CN 1-1960) as close as possible to the estimated load should be selected. In general, a greatly oversized unit which would operate intermittently will be much less satisfactory than one which is slightly undersized and which would operate more nearly continuously.
- F. Intermittent loads such as kitchen and laundry equipment are not included in this form.

COOLING LOAD ESTIMATE FORM

HEAT GAIN FROM	QUANTITY	FACTORS			BTU/Hr.																				
		DAY			(Quantity x Factor)																				
1. WINDOWS: Heat gain from the sun. Northeast _____ sq. ft. East * _____ sq. ft. Southeast _____ sq. ft. South _____ sq. ft. Southwest _____ sq. ft. West _____ sq. ft. Northwest _____ sq. ft. North _____ sq. ft.		No Shades* 60 80 75 75 110 150 120 0	Inside Shades* 25 40 30 35 45 65 50 0	Outside Awnings* 20 25 20 20 30 45 35 0	(Area X Factor) Use only the largest load. Use only one.																				
2. WINDOWS: Heat by conduction (Total of all windows.) Single glass _____ sq. ft. _____ Double glass or glass block _____ sq. ft. _____																									
3. WALLS: (Based on linear feet of wall) <table style="width: 100%; border: none;"> <tr> <td style="width: 50%;"></td> <td style="width: 25%; text-align: center;">Light Construction</td> <td style="width: 25%; text-align: center;">Heavy Construction</td> <td style="width: 10%;"></td> </tr> <tr> <td>a. Outside walls</td> <td></td> <td></td> <td></td> </tr> <tr> <td> North Exposure _____ ft.</td> <td style="text-align: center;">30</td> <td style="text-align: center;">20</td> <td style="text-align: center;">_____</td> </tr> <tr> <td> Other than North exposure _____ ft.</td> <td style="text-align: center;">60</td> <td style="text-align: center;">30</td> <td style="text-align: center;">_____</td> </tr> <tr> <td>b. Inside Walls (between conditioned and unconditioned spaces only.) _____ sq. ft.</td> <td></td> <td style="text-align: center;">30</td> <td style="text-align: center;">_____</td> </tr> </table>							Light Construction	Heavy Construction		a. Outside walls				North Exposure _____ ft.	30	20	_____	Other than North exposure _____ ft.	60	30	_____	b. Inside Walls (between conditioned and unconditioned spaces only.) _____ sq. ft.		30	_____
	Light Construction	Heavy Construction																							
a. Outside walls																									
North Exposure _____ ft.	30	20	_____																						
Other than North exposure _____ ft.	60	30	_____																						
b. Inside Walls (between conditioned and unconditioned spaces only.) _____ sq. ft.		30	_____																						
4. ROOF OR CEILING: (Use one only) <table style="width: 100%; border: none;"> <tr> <td style="width: 50%;">a. Roof, uninsulated _____ sq. ft.</td> <td style="width: 25%;"></td> <td style="width: 25%; text-align: center;">19</td> <td style="width: 10%;"></td> </tr> <tr> <td>b. Roof, 1 inch or more insulation _____ sq. ft.</td> <td></td> <td style="text-align: center;">8</td> <td style="text-align: center;">_____</td> </tr> <tr> <td>c. Ceiling, occupied space above _____ sq. ft.</td> <td></td> <td style="text-align: center;">3</td> <td style="text-align: center;">_____</td> </tr> <tr> <td>d. Ceiling, insulated, with attic space above _____ sq. ft.</td> <td></td> <td style="text-align: center;">5</td> <td style="text-align: center;">_____</td> </tr> <tr> <td>e. Ceiling, uninsulated, with attic space above _____ sq. ft.</td> <td></td> <td style="text-align: center;">12</td> <td style="text-align: center;">_____</td> </tr> </table>						a. Roof, uninsulated _____ sq. ft.		19		b. Roof, 1 inch or more insulation _____ sq. ft.		8	_____	c. Ceiling, occupied space above _____ sq. ft.		3	_____	d. Ceiling, insulated, with attic space above _____ sq. ft.		5	_____	e. Ceiling, uninsulated, with attic space above _____ sq. ft.		12	_____
a. Roof, uninsulated _____ sq. ft.		19																							
b. Roof, 1 inch or more insulation _____ sq. ft.		8	_____																						
c. Ceiling, occupied space above _____ sq. ft.		3	_____																						
d. Ceiling, insulated, with attic space above _____ sq. ft.		5	_____																						
e. Ceiling, uninsulated, with attic space above _____ sq. ft.		12	_____																						
5. Floor: (Disregard if floor is directly on ground or over a basement.) _____ sq. ft. _____																									
6. NUMBER OF PEOPLE _____ 600 _____																									
7. LIGHTS AND ELECTRICAL EQUIPMENT IN USE _____ watts 3 _____																									
8. DOORS AND ARCHES CONTINUOUSLY OPENED TO UNCONDITIONED SPACE: (TOTAL LINEAR FEET OF WIDTH.) _____ ft. 300 _____																									
9. SUBTOTAL ***** ***** _____																									
10. TOTAL COOLING LOAD (BTU per hour to be used for selection of room air conditioner(s).) <div style="text-align: right; margin-top: 10px;"> _____ Total in Item 9 X _____ (Factor from Map) = _____ </div>																									

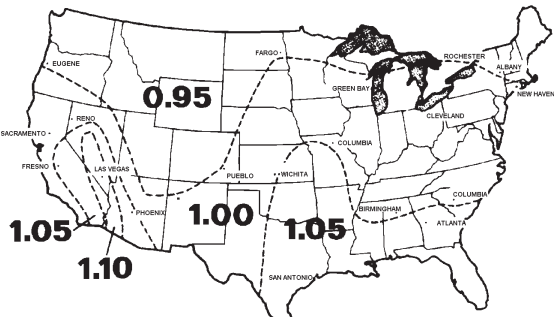

HEAT LOAD FORM

The heat load form on the following page may be used by servicing personnel to determine the heat loss of a conditioned space and the ambient winter design temperatures in which the unit will heat the calculated space.

The upper half of the form is for computing the heat loss of the space to be conditioned. It is necessary only to insert the proper measurements on the lines provided and multiply by the given factors, then add this result for the total heat loss in BTU/Hr./°F.

The BTU/Hr. per °F temperature difference is the 70°F inside winter designed temperature minus the lowest outdoor ambient winter temperature of the area where the unit is installed. This temperature difference is used as the multiplier when calculating the heat loss.

The graph shows the following:

Left Hand Scale	Unit capacity BTU/Hr. or heat loss BTU/Hr.
Bottom Scale	Outdoor ambient temperature, base point.
Heat Pump Model	BTU/Hr. capacity heat pump will deliver at outdoor temperatures.
Balance Point	Maximum BTU/Hr. heat pump will deliver at indicated ambient temperature.

Following is an example using the heat load form:

A space to be conditioned is part of a house geographically located in an area where the lowest outdoor ambient winter temperature is 40°F. The calculated heat loss is 184 BTU/Hr./°F.

Subtract 40°F (lowest outdoor ambient temperature for the geographical location) from 70°F (inside design temperature of the unit) for a difference of 30°F. Multiply 184 by 30 for a 5500 BTU/Hr. total heat loss for the calculated space.

On the graph, plot the base point (70°) and a point on the 40°F line where it intersects with the 5500 BTU/Hr. line on the left scale. Draw a straight line from the base point 70 through the point plotted at 40°F. This is the total heat loss line.

Knowing that we have a 5500 BTU/Hr. heat loss, and we expect that our heat pump will maintain a 70°F inside temperature at 40°F outdoor ambient, we plot the selected unit capacity BTU/Hr. of the unit between 35° and 60° on the graph and draw a straight line between these points. Where the total heat loss line and the unit capacity line intersect, read down to the outdoor ambient temperature scale and find that this unit will deliver the required BTU/Hr. capacity to approximately 30°F.

HEATING LOAD FORM FRIEDRICH ROOM UNIT HEAT PUMPS

	BTU/HR PER °F TEMP. DIFFERENCE
WALLS: (Linear Feet)	
2" Insulation	Lin. Ft. x 1.6
Average	Lin. Ft. x 2.6
WINDOWS & DOORS (Area, sq. ft.)	
Single Glass:	Sq. Ft. x 1.13
Double Glass:	Sq. Ft. x 0.61
INFILTRATION - WINDOWS & DOORS: AVG.	Lin. Ft. x 1.0
Loose	Lin. Ft. x 2.0
CEILING: (Area, Sq. Ft.)	
Insulated (6")	Sq. Ft. x 0.07
Insulated (2")	Sq. Ft. x 0.10
Built-up Roof (2" insulated)	Sq. Ft. x 0.10
Built-up Roof (1/2" insulated)	Sq. Ft. x 0.20
No Insulation	Sq. Ft. x 0.33
FLOOR: (Area, Sq. Ft.)	
Above Vented Crawl space	
Insulated (1:)	Sq. Ft. x 0.20
Uninsulated	Sq. Ft. x 0.50
* Slab on Ground	Lin. Ft. x 1.70
1" Perimeter insulation	Lin. Ft. x 1.00
* Based on Linear Feet of outside wall	TOTAL HEAT LOSS PER °F BTU/HR/°F

Multiply total BTU/HR/°F X 30 and plot on the graph below at 40°F. Draw a straight line from the 70 base point thru the point plotted at 40°F. The intersection of this heat loss line with the unit capacity line represents the winter design heating load.

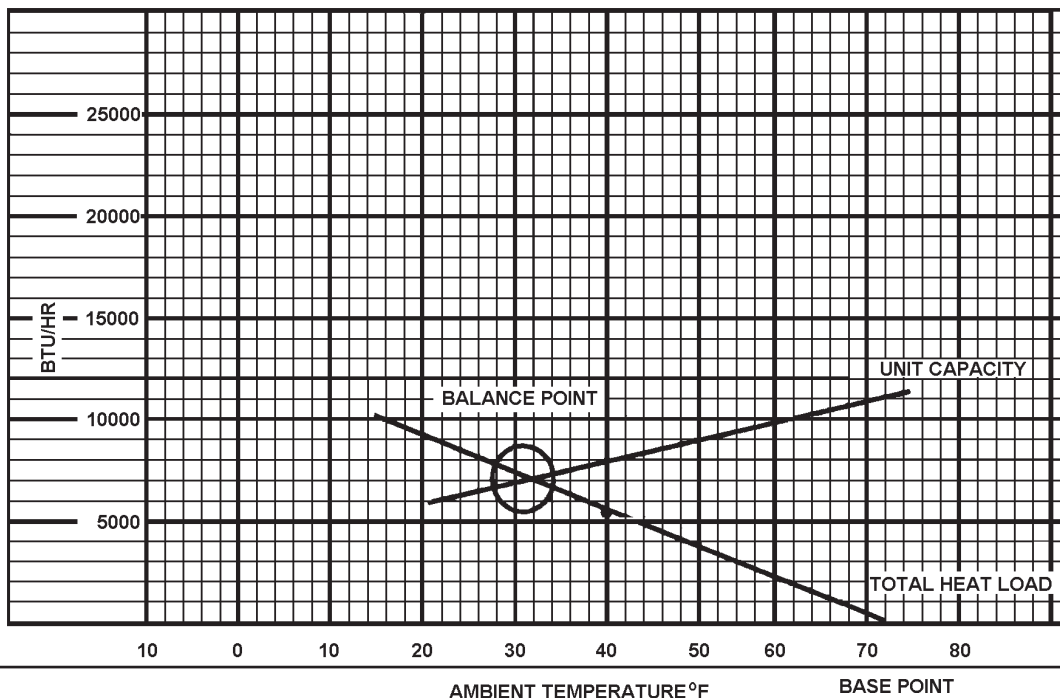



Friedrich Air Conditioning Company
P.O. Box 1540
San Antonio, TX 78295
210.357.4400
www.friedrich.com

ROOM AIR CONDITIONERS LIMITED WARRANTY

FIRST YEAR

ANY PART: If any part supplied by FRIEDRICH fails because of a defect in workmanship or material within twelve months from date of original purchase, FRIEDRICH will repair the product at no charge, provided room air conditioner is reasonably accessible for service. Any additional labor cost for removing inaccessible units and/or charges for mileage related to travel by a Service Agency that exceeds 25 miles one way will be the responsibility of the owner. This remedy is expressly agreed to be the exclusive remedy within twelve months from the date of the original purchase.

SECOND THROUGH FIFTH YEAR

SEALED REFRIGERANT SYSTEM: If the Sealed Refrigeration System (defined for this purpose as the compressor, condenser coil, evaporator coil, reversing valve, check valve, capillary, filter drier, and all interconnecting tubing) supplied by FRIEDRICH in your Room Air Conditioner fails because of a defect in workmanship or material within sixty months from date of purchase, FRIEDRICH will pay a labor allowance and parts necessary to repair the Sealed Refrigeration System; **PROVIDED** FRIEDRICH will not pay the cost of diagnosis of the problem, removal, freight charges, and transportation of the air conditioner to and from the Service Agency, and the reinstallation charges associated with repair of the Sealed Refrigeration System. All such cost will be the sole responsibility of the owner. This remedy is expressly agreed to be the exclusive remedy within sixty months from the date of the original purchase.

APPLICABILITY AND LIMITATIONS: This warranty is applicable only to units retained within the Fifty States of the U.S.A., District of Columbia, and Canada. This warranty is not applicable to:

1. Air filters or fuses.
2. Products on which the model and serial numbers have been removed.
3. Products which have defects or damage which results from improper installation, wiring, electrical current characteristics, or maintenance; or caused by accident, misuse or abuse, fire, flood, alterations and/or misapplication of the product and/or units installed in a corrosive atmosphere, default or delay in performance caused by war, government restrictions or restraints, strikes, material shortages beyond the control of FRIEDRICH, or acts of God.

OBTAINING WARRANTY PERFORMANCE: Service will be provided by the **FRIEDRICH Authorized Dealer or Service Organization** in your area. They are listed in the Yellow Pages. If assistance is required in obtaining warranty performance, write to: Room Air Conditioner Service Manager, Friedrich Air Conditioning Co., P.O. Box 1540, San Antonio, TX 78295-1540.

LIMITATIONS: THIS WARRANTY IS GIVEN IN LIEU OF ALL OTHER WARRANTIES. Anything in the warranty notwithstanding, ANY IMPLIED WARRANTIES OF FITNESS FOR PARTICULAR PURPOSE AND/OR MERCHANTABILITY SHALL BE LIMITED TO THE DURATION OF THIS EXPRESS WARRANTY. MANUFACTURER EXPRESSLY DISCLAIMS AND EXCLUDES ANY LIABILITY FOR CONSEQUENTIAL OR INCIDENTAL DAMAGE FOR BREACH OF ANY EXPRESSED OR IMPLIED WARRANTY.

Performance of Friedrich's Warranty obligation is limited to one of the following methods:

1. Repair of the unit
2. A refund to the customer for the prorated value of the unit based upon the remaining warranty period of the unit.
3. Providing a replacement unit of equal value

The method of fulfillment of the warranty obligation is at the sole discretion of Friedrich Air Conditioning.

NOTE: Some states do not allow limitations on how long an implied warranty lasts, or do not allow the limitation or exclusion of consequential or incidental damages, so the foregoing exclusions and limitations may not apply to you.

OTHER: This warranty gives you specific legal rights, and you may also have other rights which vary from state to state.

PROOF OF PURCHASE: Owner must provide proof of purchase in order to receive any warranty related services.

All service calls for explaining the operation of this product will be the sole responsibility of the consumer.

All warranty service must be provided by an **Authorized FRIEDRICH Service Agency**, unless authorized by FRIEDRICH prior to repairs being made.

(10-08)

TECHNICAL SUPPORT CONTACT INFORMATION



F R I E D R I C H

FRIEDRICH AIR CONDITIONING CO.

Post Office Box 1540 · San Antonio, Texas 78295-1540

4200 N. Pan Am Expressway · San Antonio, Texas 78218-5212

(210) 357-4400 · 877-599-5665 x 846 · FAX (210) 357-4490

Email: tac@friedrich.com

www.friedrich.com

Printed in the U.S.A.



F R I E D R I C H

FRIEDRICH AIR CONDITIONING CO.

Post Office Box 1540 · San Antonio, Texas 78295-1540

4200 N. Pan Am Expressway · San Antonio, Texas 78218-5212

(210) 357-4400 · FAX (210) 357-4490

www.friedrich.com

Printed in the U.S.A.

Kuhl-ServMan (5-10)