



Before using your air conditioner, please read  
this manual carefully and keep it for future reference.

## **INVERTER SPLIT-TYPE ROOM AIR CONDITIONER**

# **USER'S MANUAL**

The design and specifications are subject to change without prior notice for product improvement. Consult with the sales agency or manufacturer for details.

### **Read This Manual**

Inside you will find many helpful hints on how to use and maintain your air conditioner properly. Just a little preventative care on your part can save you a great deal of time and money over the life of your air conditioner. You'll find many answers to common problems in the chart of troubleshooting tips. If you review the chart of Troubleshooting Tips first, you may not need to call for service.

## **CONTENTS**

SOCIABLE REMARK	
Sociable remark.....	2
SAFETY PRECAUTIONS	
Warning .....	3
Caution .....	4
OPERATING INSTRUCTIONS	
Parts names .....	5
Special functions .....	6
Operating temperature.....	7
Manual operation .....	7
Airflow direction control .....	8
How the air conditioner works .....	9
CARE AND MAINTENANCE	
Care and maintenance .....	10
OPERATION TIPS	
Operation tips .....	12
TROUBLESHOOTING TIPS	
Troubleshooting tips .....	14

### **! CAUTION**

- Contact an authorised service technician for repair or maintenance of this unit.
- Contact the authinstaller for installation of this unit.
- This appliance is not intended for use by persons (including children) with reduced physical, sensory or mental capabilities, or lack of experience and knowledge, unless they have been given supervision or instruction concerning use of the appliance by a person responsible for their safety.
- Young children should be supervised to ensure that they do not play with the air conditioner.
- If the power cord is to be replaced, replacement work shall be performed by authorised personnel only.
- Installation work must be performed in accordance with the national wiring standards by authorised personnel only.

## **SOCIABLE REMARK**

**When using this air conditioner in the European countries, the following informations must be followed:**

**DISPOSAL:** Do not dispose this product as unsorted municipal waste. Collection of such waste separately for special treatment is necessary.

It is prohibited to dispose of this appliance in domestic household waste.

For disposal, there are several possibilities:

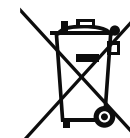

- A) The municipality has established collection systems, where electronic waste can be disposed of at least free of charge to the user.
- B) When buying a new product, the retailer will take back the old product at least free of charge.
- C) The manufacture will take back the old appliance for disposal at least free of charge to the user.
- D) As old products contain valuable resources, they can be sold to scrap metal dealers.

Wild disposal of waste in forests and landscapes endangers your health when hazardous substances leak into the ground-water and find their way into the food chain.





## SAFETY PRECAUTIONS

To prevent injury to the user or other people and property damage, the following instructions must be followed. Incorrect operation due to ignoring of instructions may cause harm or damage. The seriousness is classified by the following indications.

 <b>WARNING</b>	This symbol indicates the possibility of death or serious injury.
 <b>CAUTION</b>	This symbol indicates the possibility of injury or damage to property.

■ Meanings of symbols used in this manual are as shown below.

	<b>Never do this.</b>
	<b>Always do this.</b>

### WARNING

- |                                                                                                                                                                                                                |                                                                                                                                                                                                               |                                                                                                                                                                                      |
|----------------------------------------------------------------------------------------------------------------------------------------------------------------------------------------------------------------|---------------------------------------------------------------------------------------------------------------------------------------------------------------------------------------------------------------|--------------------------------------------------------------------------------------------------------------------------------------------------------------------------------------|
| <p><b>Ⓢ Connect with the power properly.</b></p> <ul style="list-style-type: none"> <li>• Otherwise, it may cause electric shock or fire due to excess heat generation.</li> </ul>                             | <p><b>Ⓢ Do not operate or stop the unit by switching on or off the power.</b></p> <ul style="list-style-type: none"> <li>• It may cause electric shock or fire due to heat generation.</li> </ul>             | <p><b>Ⓢ Do not damage or use an unspecified power cord.</b></p> <ul style="list-style-type: none"> <li>• It may cause electric shock or fire.</li> </ul>                             |
| <p><b>Ⓢ Do not modify power cord length or share the outlet with other appliances</b></p> <ul style="list-style-type: none"> <li>• It may cause electric shock or fire due to heat generation.</li> </ul>      | <p><b>Ⓢ Do not operate with wet hands or in damp environment.</b></p> <ul style="list-style-type: none"> <li>• It may cause electric shock.</li> </ul>                                                        | <p><b>Ⓢ Do not direct airflow at room occupants only.</b></p> <ul style="list-style-type: none"> <li>• This could damage your health.</li> </ul>                                     |
| <p><b>Ⓢ Always ensure effective earthing.</b></p> <ul style="list-style-type: none"> <li>• No earthing may cause electric shock.</li> </ul>                                                                    | <p><b>Ⓢ Do not allow water to run into electric parts.</b></p> <ul style="list-style-type: none"> <li>• It may cause failure of machine or electric shock.</li> </ul>                                         | <p><b>Ⓢ Always install circuit breaker and a dedicated power circuit.</b></p> <ul style="list-style-type: none"> <li>• No installation may cause fire and electric shock.</li> </ul> |
| <p><b>Ⓢ Disconnect the power if strange sounds, smell, or smoke comes from it.</b></p> <ul style="list-style-type: none"> <li>• It may cause fire and electric shock.</li> </ul>                               | <p><b>Ⓢ Do not drink water drained from air conditioner.</b></p> <ul style="list-style-type: none"> <li>• It contains contaminants and could make you sick.</li> </ul>                                        | <p><b>Ⓢ Do not open the unit during operation.</b></p> <ul style="list-style-type: none"> <li>• It may cause electric shock.</li> </ul>                                              |
| <p><b>Ⓢ Use the correctly rated breaker or fuse.</b></p> <ul style="list-style-type: none"> <li>• There is risk of fire or electric shock.</li> </ul>                                                          | <p><b>Ⓢ Do not use the power cord close to heating appliances.</b></p> <ul style="list-style-type: none"> <li>• It may cause fire and electric shock.</li> </ul>                                              | <p><b>Ⓢ Do not disassemble or modify unit.</b></p> <ul style="list-style-type: none"> <li>• It may cause failure and electric shock.</li> </ul>                                      |
| <p><b>Ⓢ Ventilate room before operating air conditioner if there is a gas leakage from another appliance.</b></p> <ul style="list-style-type: none"> <li>• It may cause explosion, fire and, burns.</li> </ul> | <p><b>Ⓢ Do not use the power cord near flammable gas or combustibles, such as gasoline, benzene, thinner, etc.</b></p> <ul style="list-style-type: none"> <li>• It may cause an explosion or fire.</li> </ul> |                                                                                                                                                                                      |

## SAFETY PRECAUTIONS

### CAUTION

- |                                                                                                                                                                                                                                                       |                                                                                                                                                                                                                                                       |                                                                                                                                                                                                                                                      |
|-------------------------------------------------------------------------------------------------------------------------------------------------------------------------------------------------------------------------------------------------------|-------------------------------------------------------------------------------------------------------------------------------------------------------------------------------------------------------------------------------------------------------|------------------------------------------------------------------------------------------------------------------------------------------------------------------------------------------------------------------------------------------------------|
| <p><b>Ⓢ When the air filter is to be removed, do not touch the metal parts of the unit.</b></p> <ul style="list-style-type: none"> <li>• It may cause an injury.</li> </ul>                                                                           | <p><b>Ⓢ Do not clean the air conditioner with water.</b></p> <ul style="list-style-type: none"> <li>• Water may enter the unit and degrade the insulation. It may cause an electric shock.</li> </ul>                                                 | <p><b>Ⓢ Ventilate the room well when used together with a stove, etc.</b></p> <ul style="list-style-type: none"> <li>• An oxygen shortage may occur.</li> </ul>                                                                                      |
| <p><b>Ⓢ When the unit is to be cleaned, switch off, and turn off the circuit breaker.</b></p> <ul style="list-style-type: none"> <li>• Do not clean unit when power is on as it may cause fire and electric shock, it may cause an injury.</li> </ul> | <p><b>Ⓢ Do not put a pet or house plant where it will be exposed to direct air flow.</b></p> <ul style="list-style-type: none"> <li>• This could injure the pet or plant.</li> </ul>                                                                  | <p><b>Ⓢ Do not use for special purposes.</b></p> <ul style="list-style-type: none"> <li>• Do not use this air conditioner to preserve precision devices, food, pets, plants, and art objects. It may cause deterioration of quality, etc.</li> </ul> |
| <p><b>Ⓢ Stop operation and close the window in storm or hurricane.</b></p> <ul style="list-style-type: none"> <li>• Operation with windows opened may cause wetting of indoor and soaking of household furniture.</li> </ul>                          | <p><b>Ⓢ Do not place obstacles around air-inlets or inside of air-outlet.</b></p> <ul style="list-style-type: none"> <li>• It may cause failure of appliance or accident.</li> </ul>                                                                  | <p><b>Ⓢ Turn off the main power switch when not using the unit for a long time.</b></p> <ul style="list-style-type: none"> <li>• It may cause failure of product or fire.</li> </ul>                                                                 |
| <p><b>Ⓢ Do not use strong detergent such as wax or thinner. Use a soft cloth for cleaning.</b></p> <ul style="list-style-type: none"> <li>• Appearance may be deteriorated due to change of product color or scratching of its surface.</li> </ul>    | <p><b>Ⓢ Ensure that the installation bracket of the outdoor appliance is not damaged due to prolonged exposure.</b></p> <ul style="list-style-type: none"> <li>• If bracket is damaged, there is concern of damage due to falling of unit.</li> </ul> | <p><b>Ⓢ Always insert the filters securely. Clean filter once every two weeks.</b></p> <ul style="list-style-type: none"> <li>• Operation without filters may cause failure.</li> </ul>                                                              |
| <p><b>Ⓢ Do not place heavy object on the power cord and take care so that the cord is not compressed.</b></p> <ul style="list-style-type: none"> <li>• There is danger of fire or electric shock.</li> </ul>                                          | <p><b>Ⓢ Use caution when unpacking and installing. Sharp edges could cause injury.</b></p>                                                                                                                                                            | <p><b>Ⓢ If water enters the unit, turn the unit off and disconnect the power, contact a qualified service technician.</b></p>                                                                                                                        |

## OPERATING INSTRUCTIONS

### Parts names

#### Indoor unit

NOTE: The indoor unit you purchased would like one of the following. There is a slightly difference on front panel and display window, but the features are the same.

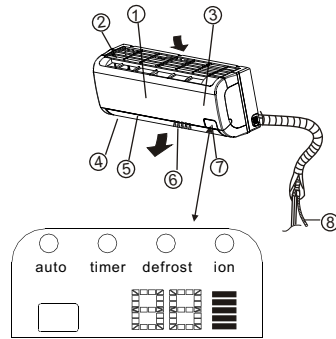

(A)

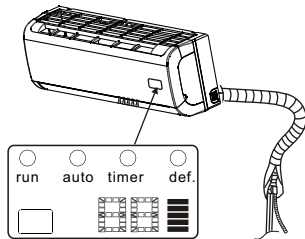

(B)

#### Outdoor unit

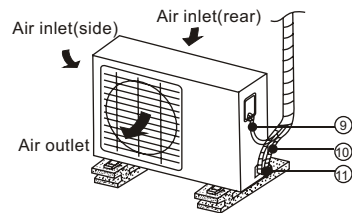

#### Indoor unit

1. Front panel
2. Air inlet
3. Air filter(under the panel)
4. Air outlet
5. Horizontal air flow grille
6. Vertical air flow louver(inside)
7. Display panel
8. Connecting pipe, drain hose

#### Outdoor unit

9. Connective cable
10. Connecting pipe
11. Stop valve

**NOTE:**  
All the pictures in this manual are for explanation purpose only. Your air conditioner may be slightly different. The actual shape shall prevail.

## OPERATING INSTRUCTIONS

### Indicator Lights on Display panel

**NOTE:**The display panel of the indoor unit you purchased may be look like one of the following:

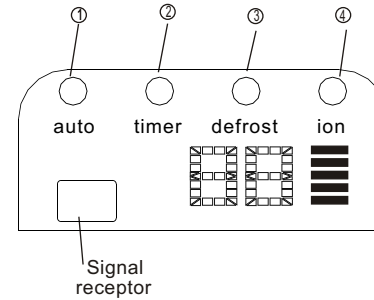

(A)

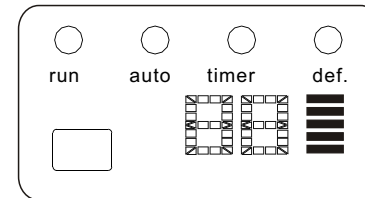

(B)

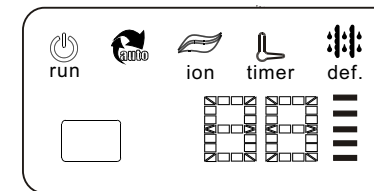

(C)

- ① **Auto indicator:**  
This indicator illuminates when the air conditioner is in AUTO operation.
- ② **Timer indicator:**  
This indicator illuminates when TIMER is set ON/OFF.
- ③ **Defrost Indicator**  
(For cooling & heating model only):  
This indicator illuminates when the air conditioner starts defrosting automatically or when the warm air control feature is activated in heating operation.
- ④ **Ion Indicator**  
Lights up when Ion feature is activated and ionizer can generate abundant anions to fill the room with refreshing and natural air.  
*NOTE: This function is only available for air conditioner adopts Ionizer.*

**DIGITAL DISPLAY:**  
Displays the current setting temperature and malfunction/protection code when the air conditioner is in operation. Displays the room temperature under fan only mode.

**Frequency display:**  
This display is separated into five zones. The zones illuminate based on the compressor current frequency. For example, higher frequency will illuminate more zones.

**RUN indication lamp**  
This lamp illuminates when the air conditioner is in operation.

**AUTO indication lamp**  
Lights up during the Auto operation.

**Ion indication lamp(optional function)**  
Lights up when Clean Air feature is activated and ionizer can generate abundant anions to fill the room with refreshing and natural air.

**TIMER indication lamp**  
Lights up during Timer operation.

**DEFROST indication lamp**  
(For cooling & heating models only):  
Lights up when the air conditioner starts defrosting automatically or when the warm air control feature is activated in heating operation.

## OPERATING INSTRUCTIONS

**NOTE:** This manual does not include Remote Controller Operations, see the <<Remote Controller Instruction>> packed with the unit for details.

### Operating temperature

Mode	Cooling operation	Heating operation	Drying operation
Room temperature	$\geq 17^{\circ}\text{C}$ (62°F)	$\leq 30^{\circ}\text{C}$ (88°F)	$> 10^{\circ}\text{C}$ (50°F)
Outdoor temperature	0°C~50°C (32°F~122°F)	-15°C~34°C (5°F~92°F)	0°C ~50°C (32°F~122°F)
	(-15°C~50°C/5°F~122°F: For the models with low temperature cooling system)		

#### CAUTION:

1. If air conditioner is used outside of the above conditions, certain safety protection features may come into operation and cause the unit to function abnormally.
2. Room relative humidity less than 80%. If the air conditioner operates in excess of this figure, the surface of the air conditioner may attract condensation. Please set the vertical air flow louver to its maximum angle (vertically to the floor), and set HIGH fan mode.
3. Optimum performance will be achieved within these operating temperature.

**Suggestion:** For the unit adopts an Electric Heater, when the outside ambient temperature is below 0°C(32°F), we strongly recommend you to keep the machine plugged in order to guarantee it running smoothly.

### Manual operation

Manual operation can be used temporarily in case the remote controller is disabled or maintenance necessary.

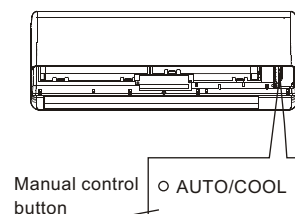
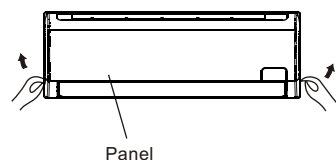

- NOTE:** The unit must be turned off before operating the manual control button. If the unit is operational, continue pressing the manual control button until the unit is off.
- ① Open and lift the front panel up to an angle until it remains fixed with a clicking sound.
  - ② One press of the manual control button will lead to the forced AUTO operation. If press the button twice within five seconds, the unit will operate under forced COOL operation.
  - ③ Close the panel firmly to its original position.

#### CAUTION:

- This button is used for testing purposes only. You had better not choose it.
- To restore the remote controller operation, use the remote controller directly.

7

## OPERATING INSTRUCTIONS

### Airflow direction control

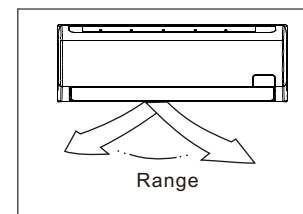
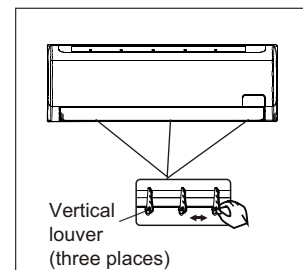
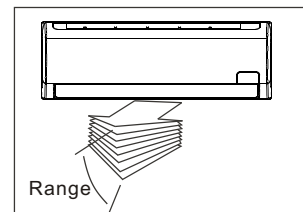

- Adjust the air flow direction properly otherwise, it might cause discomfort or cause uneven room temperatures.
- Adjust the horizontal louver using the remote controller.
- Adjust the vertical louver manually.

To set the vertical air flow (Up--Down) direction. Perform this function while the unit is in operation. Use the remote controller to adjust the air flow direction. The horizontal louver can be moved at a range of 60° for each press, or swing up and down automatically. Please refer to the 'REMOTE CONTROLLER OPERATION MANUAL' for details.

To set the horizontal air flow direction (left - right)

- Move the vertical louver manually to adjust the air flow in the direction you prefer.
- **IMPORTANT:** Before adjusting the vertical louvers, the supply power must be disconnected.
- For some models, the vertical louver can be adjusted by using the remote controller. Please refer to the 'REMOTE CONTROLLER OPERATION MANUAL' for details.

#### CAUTION

- Do not operate the air conditioner for long periods with the air flow direction set downward in cooling or dehumidifying mode. Otherwise, condensation may occur on the surface of the horizontal louver causing moisture to drop on to the floor or on furnishings.
- Do not move the horizontal louver manually unless it is necessary. Always use the remote controller.
- When the air conditioner is started immediately after it was stopped, the horizontal louver might not move for approximately 10 seconds.
- Open angle of the horizontal louver should not be set too small, as COOLING or HEATING performance may be impaired due to too restricted air flow area.
- Do not operate unit with horizontal louver in closed position.
- When the air conditioner is connected to power (initial power), the horizontal louver may generate a sound for 10 seconds, this is a normal operation.

8

## OPERATING INSTRUCTIONS

### How the air conditioner works

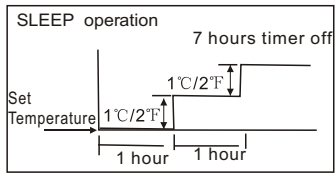

#### Cooling

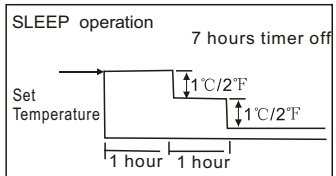

#### Heating

#### AUTO operation

- When you set the air conditioner in AUTO mode, it will automatically select cooling, heating (cooling/heating models only), or fan only operation depending on what temperature you have selected and the room temperature.
- The air conditioner will control room temperature automatically around the temperature point set by you.
- If the AUTO mode is uncomfortable, you can select desired conditions manually.

#### SLEEP operation

When you push SLEEP button on remote controller during cooling, heating (cooling & heating models only), or AUTO operation, the air conditioner will automatically increase (cooling) or decrease (heating) 1°C/2°F per hour for the first 2 hours, then hold steady for the next 5 hours, after that it will switch off. This characteristic maintains both energy saving and comfort in night operation.

#### DRYING operation

- The fan speed will be automatically controlled under dry operation.
- During the dry operation, if the room temperature is lower than 10°C (50°F), the compressor stops operation and restarts until the room temperature is above 12°C (54°F).

#### Optimal operation

- To achieve optimal performance, please note the following:
- Adjust the air flow direction correctly so that it is not directed on people.
- Adjust the temperature to achieve the highest comfort level. Do not adjust the unit to excessive temperature levels.
- Close doors and windows on COOL or HEAT modes, or performance may be reduced.
- Use TIMER ON button on the remote controller to select a time you want to start your air conditioner.
- Do not put any object near air inlet or air outlet, as the efficiency of the air conditioner may be reduced and the air conditioner may stop running.
- Clean the air filter periodically, otherwise cooling or heating performance may be reduced.
- Do not operate unit with horizontal louvre in closed position.

## CARE AND MAINTENANCE

### Care and maintenance

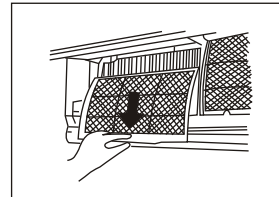
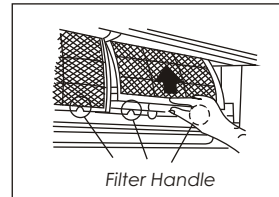
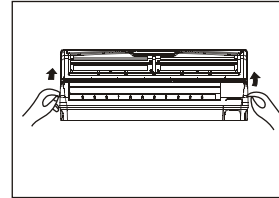

#### Cleaning the Grille, Case and Remote Controller

- Turn the system off before cleaning. To clean, wipe with a soft, dry cloth. Do not use bleach or abrasives.

**NOTE: Supply power must be disconnected before cleaning the indoor unit.**

#### CAUTIONS

- A cloth dampened with cold water may be used on the indoor unit if it is very dirty. Then wipe it with a dry cloth.
- Do not use a chemically treated cloth or duster to clean the unit.
- Do not use benzene, thinner, polishing powder, or similar solvents for cleaning. These may cause the plastic surface to crack or deform.
- Never use water hotter than 40°C/104°F to clean the front panel, it could cause deformation of discoloration.

#### Cleaning the air filter

A clogged air filter reduces the cooling efficiency of this unit. Please clean the filter once every 2 weeks.

1. Lift the indoor unit panel up to an angle until it stops with a clicking sound.
2. Take hold of the handle of the air filter and lift it up slightly to take it out from the filter holder, then pull it downwards.
3. Remove the AIR FILTER from the indoor unit.
  - Clean the AIR FILTER once two weeks.
  - Clean the AIR FILTER with a vacuum cleaner or water, then dry it up in cool place.

## CARE AND MAINTENANCE

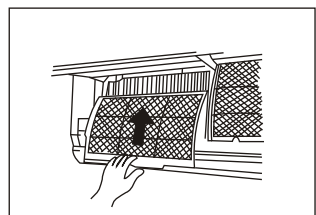
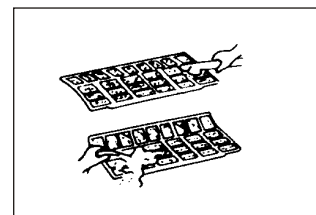
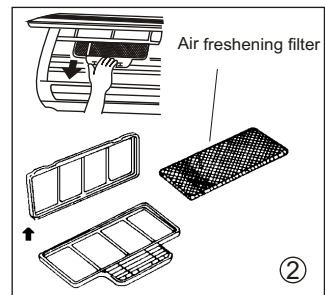
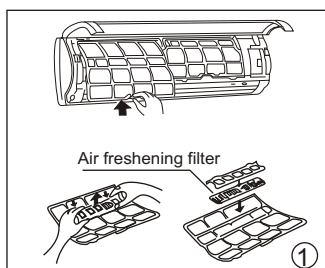

4. Remove the Air Freshening Filter from its support frame (on some models).  
(The optional filter include :Plasma Dust Collector/ Silver Ion filter /Bio filter /Vitamin C filter/3M air purifier filter, etc. The removing and installation methods are slightly different, see the pictures marked ① and ② on the left.
- Clean the air freshening filter at least once a month, and replace it every 4-5 months.
- Clean it with vacuum cleaner, then dry it in cool place.

⚠ Do not touch the Plasma Dust Collector Filter within 10 minutes after opening the front panel, it may cause an electric shock.

5. Install the air freshening filter back into position.
6. Insert the upper portion of air filter back into the unit, taking care that the left and right edges line up correctly and place filter into position.

### Maintenance

If you plan to idle the unit for a long time, perform the following:

- (1) Operate the fan for about half a day to dry the inside of the unit.
- (2) Stop the air conditioner and disconnect power. Remove the batteries from the remote controller.
- (3) The outdoor unit requires periodic maintenance and cleaning. Do not attempt to do this yourself. Contact your dealer or servicer.

### Checks before operation

- Check that the wiring is not broken off or disconnected.
- Check that the air filter is installed.
- Check if the air outlet or inlet is blocked after the air conditioner has not been used for a long time.

### ⚠ Caution

- Do not touch the metal parts of the unit when removing the filter. Injuries can occur when handling sharp metal edges.
- Do not use water to clean inside the air conditioner. Exposure to water can destroy the insulation, leading to possible electric shock.
- When cleaning the unit, first make sure that the power and circuit breaker are turned off.

## OPERATION TIPS

The following events may occur during normal operation.

1. Protection of the air conditioner.

### Compressor protection

- The compressor can't restart for 3 minutes after it stops.

### Anti-cold air (Cooling and heating models only)

- The unit is designed not to blow cold air on HEAT mode, when the indoor heat exchanger is in one of the following three situations and the set temperature has not been reached.
  - A) When heating has just starting.
  - B) Defrosting.
  - C) Low temperature heating.

- The indoor or outdoor fan stop running when defrosting (Cooling and heating models only).

### Defrosting (Cooling and heating models only)

- Frost may be generated on the outdoor unit during heat cycle when outdoor temperature is low and humidity is high resulting in lower heating efficiency of the air conditioner.
- During this condition air conditioner will stop heating operation and start defrosting automatically.
- The time to defrost may vary from 4 to 10 minutes according to the outdoor temperature and the amount of frost build up on the outdoor unit.

2. A white mist coming out from the indoor unit

- A white mist may generate due to a large temperature difference between air inlet and air outlet on COOL mode in an indoor environment that has a high relative humidity.
- A white mist may generate due to moisture generated from defrosting process when the air conditioner restarts in HEAT mode operation after defrosting.

3. Low noise of the air conditioner

- You may hear a low hissing sound when the compressor is running or has just stopped running. This sound is the sound of the refrigerant flowing or coming to a stop.
- You can also hear a low "squeak" sound when the compressor is running or has just stopped running. This is caused by heat expansion and cold contraction of the plastic parts in the unit when the temperature is changing.
- A noise may be heard due to louver restoring to its original position when power is first turned on.

4. Dust is blown out from the indoor unit.

This is a normal condition when the air conditioner has not been used for a long time or during first use of the unit.

5. A peculiar smell comes out from the indoor unit.

This is caused by the indoor unit giving off smells permeated from building material, from furniture, or smoke.

6. The air conditioner turns to FAN only mode from COOL or HEAT (For cooling and heating models only) mode.

When indoor temperature reaches the temperature setting on air conditioner, the compressor will stop automatically, and the air conditioner turns to FAN only mode. The compressor will start again when the indoor temperature rises on COOL mode or falls on HEAT mode (For cooling and heating models only) to the set point.

**OPERATION TIPS**

7. Dripping water may generate on the surface of the indoor unit when cooling in a high relatively humidity (relative humidity higher than 80%). Adjust the horizontal louver to the maximum air outlet position and select HIGH fan speed.
8. Heating mode (For cooling and heating models only)  
The air conditioner draws in heat from the outdoor unit and releases it via the indoor unit during heating operation. When the outdoor temperature falls, heat drawn in by the air conditioner decreases accordingly. At the same time, heat loading of the air conditioner increases due to larger difference between indoor and outdoor temperature. If a comfortable temperature can't be achieved by the air conditioner, we suggest you use a supplementary heating device.
9. Auto-restart function  
Power failure during operation will stop the unit completely.
  - For the unit without Auto-restart feature, when the power restores, the OPERATION indicator on the indoor unit starts flashing. To restart the operation, push the ON/OFF button on the remote controller. For the unit with Auto-restart feature, when the power restores, the unit restarts automatically with all the previous settings preserved by the memory function.
  - For some models, the machine is special designed with Auto-restart function for the open angle of the horizontal louver. Power failure during operation or pressing the ON/OFF button on the remote controller will stop the unit completely. When the power restores or pressing the ON/OFF button on the remote controller again, the unit restarts automatically with all the previous settings including the open angle of the horizontal louver by the memory function. So we strongly suggest that the open angle of the horizontal louver should not be set too small, in case the condensed water forms and drops from the horizontal louver. Press the AUTO/COOL button under the front panel and the open angle of the horizontal louver will be restored to the standard angle when the condensed water forms on the horizontal louver.
10. Lightning or a car wireless telephone operating nearby may cause the unit to malfunction. Disconnect the unit with power and then re-connect the unit with power again. Push the ON/OFF button on the remote controller to restart operation.
11. **The protection of outdoor low temperature (on some models)**  
The protection of outdoor low temperature can be activated only in the HEATING mode. The unit will stop operating and display "P3" on the LCD window of the indoor unit when the outdoor temperature is or lower than 5°F (-15°C) for one hour, but the indoor unit in this situation can still receive the signal from the remote controller. The unit will restart automatically with all the previous settings preserved by the memory function when the outdoor temperature is or higher than 11°F (-12°C) for 10 minutes and the compressor stop operating for more than one hour, or when the outdoor temperature is or higher than 41°F (5°C) for 10 minutes.

**Troubleshooting Tips**

Stop the air conditioner immediately if one of the following faults occur. Disconnect the power and contact the nearest customer service center.		
<b>Trouble</b>	If the following code appears on the LED window, disconnect the power and contact the service people: E0,E1,E2,E3,E4,E5,E6,E7,E8 or P0,P1,P2,P3,P4, P6.	
	Fuse blows frequently or circuit breaker trips frequently.	
	Other objects or water penetrate the air conditioner.	
	The remote controller won't work or works abnormally.	
	Operaton indicator or other indicators flash rapidly and this flash can not be stopped by disconnecting the power and then connecting it in again.	
<b>Malfuncions</b>	<b>Cause</b>	<b>What should be done?</b>
<b>Unit does not start</b>	Power cut	Wait for power to be restored.
	Unit may have become unplugged.	Check that plug is securely in wall receptacle.
	Fuse may have blown.	Replace the fuse.
	Battery in Remote controller may have been exhausted.	Replace the battery.
	The time you have set with timer is incorrect.	Wait or cancel timer setting.
<b>Unit not cooling or heating (Cooling/ heating models only) room very well while air flowing out from the air conditioner</b>	Inappropriate temperature setting.	Set temperature correctly. For detailed method please refer to "Using remote control" section.
	Air filter is blocked.	Clean the air filter.
	Doors or Windows are open.	Close the doors or windows.
	Air inlet or outlet of indoor or outdoor unit has been blocked.	Clear obstructions away first, then restart the unit.
	Compressor 3 minutes protection has been activated.	Wait.
If the trouble has not been corrected, please contact a local dealer or the nearest customer service center. Be sure to inform them of the detailed malfunctions and unit model.		

**Notes: Do not attempt to repair the unit yourself.  
Always consult an authorised service provider.**



# WARRANTY

NAPOLEON® products are manufactured under the strict Standard of the world recognized ISO 9001 : 2008 Quality Assurance Certificate.

NAPOLEON® products are designed with superior components and materials assembled by trained craftsmen who take great pride in their work. The complete appliance is thoroughly inspected by a qualified technician before packaging to ensure that you, the customer, receives the quality product that you expect from NAPOLEON®.

## NAPOLEON® DUCTLESS AIR CONDITIONER LIMITED WARRANTY

The following materials and workmanship in your new NAPOLEON® Ductless Air Conditioner are warranted against defects. NAPOLEON® will provide a replacement compressor should it fail within 5 years from the original date of purchase. All other parts are covered by this warranty for the first year only. Should a part fail due to defect within the first year, NAPOLEON® reserves the right to replace the defective part or the entire evaporator or condenser assembly at NAPOLEON's discretion. Diagnostics, transportation or labour charges related to warranty repair is not covered.

\* Construction of models vary. Warranty applies only to components included with your specific appliance.

## CONDITIONS AND LIMITATIONS

NAPOLEON® warrants its products against manufacturing defects to the original purchaser only. Registering your warranty is not necessary. Simply provide your proof of purchase along with the model and serial number to make a warranty claim.

NAPOLEON® reserves the right to have its representative inspect any product or part thereof prior to honouring any warranty claim. Provided that the purchase was made through an authorized NAPOLEON® dealer your air conditioner is subject to the following conditions and limitations:

This factory warranty is non-transferable and may not be extended whatsoever by any of our representatives.

The appliance must be installed by a licensed, authorized service technician or contractor. Installation must be done in accordance with the installation instructions included with the product and all local and national building and fire codes. This limited warranty does not cover damages caused by misuse, lack of maintenance, loss of refrigerant, accident, alterations, abuse or neglect and parts installed from other manufacturers will nullify this warranty.

This limited warranty further does not cover any scratches, dents, corrosion or discoloring caused by excessive heat, abrasive and chemical cleaners.

In the first year only, this warranty extends to the repair or replacement of warranted parts which are defective in material or workmanship provided that the product has been operated in accordance with the operation instructions and under normal conditions.

After the first year, with respect to this Limited Warranty, NAPOLEON® may, at its discretion, fully discharge all obligations with respect to this warranty by refunding to the original warranted purchaser the wholesale price of any warranted but defective part(s).

NAPOLEON® will not be responsible for installation, labour or any other expenses related to the reinstallation of a warranted part and such expenses are not covered by this warranty.

Notwithstanding any provisions contained in the Limited Warranty, NAPOLEON's responsibility under this warranty is defined as above and it shall not in any event extend to any incidental, consequential or indirect damages.

This warranty defines the obligations and liability of NAPOLEON® with respect to the NAPOLEON® appliance and any other warranties expressed or implied with respect to this product, its components or accessories are excluded.

NAPOLEON® neither assumes, nor authorizes any third party to assume, on its behalf, any other liabilities with respect to the sale of this product.

Any damages to the appliance due to water, weather damage, long periods of dampness, condensation, damaging chemicals or cleaners will not be the responsibility of NAPOLEON®.

All parts replaced under the Limited Warranty Policy are subject to a single claim.

All parts replaced under the warranty will be covered for a period of 90 days from the date of their installation.

The manufacturer may require that defective parts or products be returned or that digital pictures be provided to support the claim.

Returned products are to be shipped prepaid to the manufacturer for investigation. If a product is found to be defective, the manufacturer will repair or replace such defect.

Before shipping your appliance or defective components, your shipping dealer must obtain an authorization number. Any merchandise shipped without authorization will be refused and returned to sender.

Shipping costs are not covered under this warranty.

Additional service fees may apply if you are seeking warranty service from a dealer.

ALL SPECIFICATIONS AND DESIGNS ARE SUBJECT TO CHANGE WITHOUT PRIOR NOTICE DUT TO ON-GOING PRODUCT IMPROVEMENTS. NAPOLEON® IS A REGISTERED TRADEMARK OF WOLF STEEL LTD. PATENTS U.S. 5.303.693.801 - CAN. 2.073.411, 2.082.915 © WOLF STEEL LTD.



**OWNER'S MANUAL**

# **REMOTE CONTROLLER**

The design and specifications are subject to change without prior notice for product improvement. Consult with the sales agency or manufacturer for details.

- Please read this Owner's Manual carefully before operation.
- Save this manual in a safe place for future reference.

## CONTENTS

Remote Controller Specification.....	1
Performance Features.....	4
Features of the Remote controller Buttons .....	1
Indicators on Display panel.....	3
Operating the Remote Controller.....	4
Warning.....	7

### 3. Set the starting & stopping time

- 3.1 Push the TIMER ON button, the remote controller will show TIMER ON, the last set time for START operation and the signal "h" will be shown on the DIGITAL display area. You are now ready to readjust the TIMER ON to start the operation.
- 3.2 Push the TIMER ON button again to set the time you want to start the operation.
- 3.3 Push the TIMER OFF button, the remote controller will show TIMER OFF, the last set time for STOP operation and the signal "h" will be shown on the DIGITAL display area. You are now ready to reset the time to STOP operation.
- 3.4 Push the TIMER OFF button again to set the time you want to stop the operation.
- 3.5 After setting the TIMER, there will be a one-half second delay before the remote controller transmits the signal to the Air Conditioner. Then, after approximately another 2 seconds, the signal "h" disappears and the set temperature will re-appear on the digital display.

### Change the TIMER

- To change the TIMER ON/OFF time, just press the corresponding TIMER button and reset the time.
- To cancel the TIMER ON/OFF setting, just adjust the TIMER time to 0:00.

### ▲NOTE

The setting time is relative time. That is the time set is based on the delay of the current time.

### Warning

1. Be sure there are no obstacles between the remote controller and the receiver of indoor unit otherwise the air conditioner will not work.
2. Keep the Remote Controller away from any liquids.
3. Protect the remote controller from the high temperatures and exposure to radiation.
4. Keep the indoor receiver out of direct sunlight or the Air Conditioner may malfunction.
5. Keep Remote Controller away from EMI(Electro-Magnetic Interference) supplied by other household appliances.

### Remote Controller Specification

Model	RG51M5/(C)EU
Rated Voltage	3.0V(Dry batteries LR03 ×2)
Lowest Voltage of CPU Emitting Signal	2.0V
Transmission Distance	8m
Environment	23°F~140°F

### Performance Features

1. Operating Mode: AUTO、COOL、 DRY、 HEAT(Cooling only model without) and FAN .
2. Timer Setting Function in 24 hours.
3. Indoor Setting Temperature Range: 62°F~ 86°F
4. Full function of LCD (Liquid Crystal Display)

### Features of Remote controller buttons

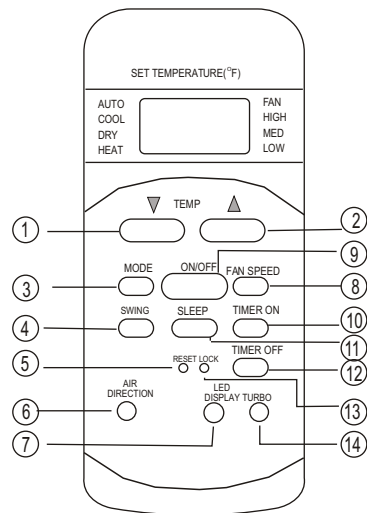

Fig. 1

- ① **TEMP Button ▼**: Push this button to decrease the indoor temperature setting.
- ② **TEMP Button ▲**: Push this button to increase the indoor temperature setting .
- ③ **MODE Selection Button**: Each time the button is pressed, the operation mode is shifted in the direction of the arrow:



**▲NOTE:** COOL only model has no HEAT feature.

- ④ **SWING Button**: Push this switch button to activate auto swing feature of the horizontal louver. Push it again to stop.
  - ⑤ **RESET Button**: When you press the recessed RESET button, all current settings are cancelled and the control will return to the initial settings.
  - ⑥ **AIR DIRECTION Button**: Press this button to change the swing angle of the louver. The swing angle of the louver is 6° for each press. When the louver swing at a certain angle which would affect the cooling and heating effect of the air conditioner, it would automatically change the swing direction . No symbol will appear in the display area when press this button.
  - ⑦ **LED DISPLAY Button**: Press this button to clear the digit display in the air conditioner, press it again to illuminate (Not available for the units without LED display window).
  - ⑧ **FAN SPEED Button**: Used to select the Fan Speed in four steps- AUTO 、 LOW 、 MED or HIGH. Each time the button is pressed, the fan speed mode is shifted.
  - ⑨ **ON/OFF Button**: Push this button to start operation, push the button again to stop operation.
  - ⑩ **TIMER ON Button**: Press this button to initiate the auto-on time sequence. Each press will increase the auto-timed setting in 30 minutes increments. When the setting time displays 10h, each press will increase the auto-timed setting 60 minutes increments. To cancel the auto-timed program, simply adjust the auto-on time to 0.0.
  - ⑪ **SLEEP Button**: Press this button to go into the Energy-Saving operation mode. Press it again to cancel. This function is only can be used on COOL, HEAT and AUTO mode and maintain the most comfortable temperature for you.
- ▲NOTE:** While the unit is running under SLEEP operation mode, it would be canceled if you press the MODE,FAN SPEED or ON/OFF button.

- ⑫ **TIMER OFF Button:** Press this button to initiate the auto-off time sequence. Each press will increase the auto-timed setting in 30 minutes increments. When the setting time displays 10h, each press will increase the auto-timed setting 60 minutes increments. To cancel the auto-timed program, simply adjust the auto-off time to 0.0
- ⑬ **LOCK Button:** When you press the recessed LOCK button, all current settings are locked in and the remote controller does not accept any operation except that of the LOCK. Press again to cancel the LOCK mode.
- ⑭ **TURBO Button:** Push this button on COOL mode, the air conditioner goes into powerful cooling operation. Push again to cancel the TURBO function(Not available for the air conditioner without TURBO function).

### Indicators on Display Panel

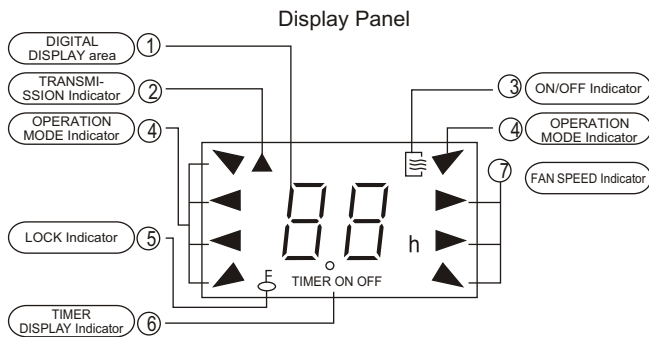

Fig. 2

- ① **DIGITAL DISPLAY area:** This area will show the set temperature and, if in the TIMER mode, will show the ON and OFF settings of the TIMER. If in the FAN mode, nothing is appeared.
- ② **TRANSMISSION Indicator:** This indicator flashes one time when remote controller transmits signals to the indoor unit.

- ③ **ON/OFF Indicator:** This symbol appears when the unit is turned on by the remote controller, and disappear when the unit is turned off.
- ④ **OPERATION MODE Indicator:** When press the MODE button, it shows the current operating mode -- "AUTO", "COOL", "DRY", "HEAT"(Cooling only model without) , or "FAN" mode.
- ⑤ **LOCK Indicator:** LOCK display is displayed by pushing the LOCK button. Push the LOCK button to clear display.
- ⑥ **TIMER DISPLAY Indicator:** This display area shows the settings of the TIMER. That is, if only the starting time of operation is set, it will display the TIMER ON. If only the turning off time of operation is set, it will display the TIMER OFF. If both operations are set, it will show TIMER ON-OFF which indicates you have chosen to set both the starting time and off time.
- ⑦ **FAN SPEED Indicator:** Press the FAN SPEED button to select the desired fan speed setting (Auto-Low-Med-High). You selection will be displayed in the LCD window except the Auto fan speed.

**▲ NOTE:** All signs shown in the Fig.2 is for the purpose of clear presentation. But during the actual operation only the relative functional signs are shown on the display panel.

### Operating the Remote Controller

#### 🔑 Install/Replace Batteries

The Remote Controller uses two alkaline dry batteries(LR03X2).

1. To install the batteries, slide the back cover of the battery compartment and install the batteries according the direction (+and -)shown on the Remote Controller.
2. To replace the old batteries, use the same method as mentioned above.

#### ▲ NOTE

1. When replacing batteries, do not use old batteries or a different type battery. This may cause the remote control to malfunction.
2. If you do not use the remote controller for several weeks remove the batteries. Otherwise battery leakage may damage the remote controller.
3. The average battery life under normal use is about 6 months.
4. Replace the batteries when there is no answering beep from the indoor unit or if the Transmission Indicator light fails to light.
5. Do not dispose batteries as unsorted municipal waste. Collection of such waste separately for special treatment is necessary.

## AUTOMATIC OPERATION

Switch on the power and the OPERATION indication lamp on the display panel of the indoor unit starts flashing, and turns off after flashes for 6 times.

1. Use the MODE button to select AUTO.
2. Push the TEMP button to set the desired temperature within a range of 62°F ~ 86°F.
3. Push the ON/OFF button to start the air conditioner. The OPERATION lamp on the display panel of the indoor unit lights. The FAN SPEED is automatically set and there are no fan speed indicators shown on the display panel of the remote controller.
4. Push the ON/OFF button again to stop the unit operation.

### NOTE

1. In the AUTO mode, the air conditioner can logically choose the mode of COOL, FAN and HEAT by sensing the difference between the actual ambient room temperature and the set temperature on the remote controller.
2. If the AUTO mode is not comfortable for you, the desired mode can be selected manually.

## COOL/ HEAT (Cooling only model without) and FAN Operation

1. If the AUTO mode is not comfortable, you may manually over-ride the settings by using COOL, HEAT or FAN modes.
2. Push the TEMP button to set the desired temperature within a range of 62°F ~ 86°F.
3. Push the FAN SPEED to select the FAN mode of AUTO, HIGH, MED or LOW.
4. Push the ON/OFF button, the operation lamp lights and the air conditioner start to operate as your settings. Push the ON/OFF button again to stop this unit operation.

### NOTE

- The FAN mode can not be used to control the temperature. While in this mode, only steps 1、3 and 4 may be performed.

## DRY Operation

1. Push the MODE button to select DRY.
2. Push the TEMP button to set the desired temperature within a range of 62°F ~ 86°F.
3. Push the ON/OFF button, the OPERATION lamp lights and the air conditioner starts to operate in DRY mode at LOW fan speed. Push the ON/OFF button again to stop this unit operation.

### NOTE

*Due to the difference of the set temperature of the unit and the actual indoor temperature, the Air Conditioner when in DRY mode will automatically operate many times without running the COOL and FAN mode.*

## TIMER Operation

Push TIMER ON button to set the auto- on time and TIMER OFF button to set the auto-off time.

### 1. To set the starting time.

- 1.1 Push the TIMER ON button, then the remote controller shows TIMER ON, the last set time for the starting operation and the signal "h" will be shown on the DIGITAL DISPLAY area. You are now ready to reset the time to START the operation.
- 1.2 Push the TIMER ON button again to set desired unit start time.
- 1.3 After setting the TIMER ON, there will be a one-half second delay before the remote controller transmits the signal to the air conditioner. Then, after approximately another 2 seconds, the signal "h" disappears and the set temperature will re-appear on the digital display.

### 2. To set the stopping time.

- 2.1 Push the TIMER OFF button and the remote controller will show TIMER OFF, the last set time for the stopping operation and the signal "h" will be shown on the DIGITAL DISPLAY area. You are now ready to reset the time of the STOP operation.
- 2.2 Push the TIMER OFF button again to set the time you want to stop the operation.
- 2.3 After setting the TIMER OFF, there will be a one-half second delay before the remote controller transmits the signal to the air conditioner. Then, after approximately another 2 seconds, the signal "h" disappears and the set temperature will re-appear on the digital display.



Before using your air conditioner, please read  
this manual carefully and keep it for future reference.

# INVERTER SPLIT-TYPE ROOM AIR CONDITIONER

## **INSTALLATION MANUAL**

- Please read this installation manual completely before installing the product.
- If the power cord is damaged, replacement work shall be performed by authorised personnel only.
- Installation work must be performed in accordance with the national wiring Standards by authorised personnel only.
- Contact an authorised service technician for repair, maintenance or installation of this unit.

# CONTENTS

---

## **SAFETY PRECAUTIONS**

Warning .....	2
Caution .....	2

## **INSTALLATION INSTRUCTIONS**

Selecting installation place.....	3
Accessories .....	4
Indoor unit installation.....	5
Outdoor unit installation .....	7

## **REFRIGERANT PIPE CONNECTION**

Refrigerant pipe connection .....	8
-----------------------------------	---

## **ELECTRICAL WORK**

Electrical work .....	9
-----------------------	---

## **AIR PURGING**

Air purging with vacuum pump .....	11
Safety and leakage check .....	13

## **TEST RUNNING**

Test running .....	13
--------------------	----

## **Read This Manual**

Inside you will find many helpful hints on how to install and test the air conditioner properly.

### **CAUTION**



- Contact an authorised service technician for repair or maintenance of this unit.
- Contact an authorised installer for installation of this unit.
- This appliance is not intended for use by persons(including children) with reduced physical, sensory or mental capabilities, or lack of experience and knowledge, unless they have been given supervision or instruction concerning use of the appliance by a person responsible for their safety.
- Children should be supervised to ensure that they do not play with the appliance.
- If the power cord is to be replaced, replacement work shall be performed by authorised personnel only.
- Installation work must be performed in accordance with the national wiring Standards by authorised personnel only.



## SAFETY PRECAUTIONS





- Read the follow SAFETY PRECAUTIONS carefully before installation.
- Electrical work must be installed by a licensed electrician. Be sure to use the correct rating of the power plug and main circuit for the model to be installed.
- Incorrect installation due to ignoring of the instruction will cause harm or damage.

■ The seriousness is classified by the following indications.

 <b>WARNING</b>	This symbol indicates the possibility of death or serious injury.
 <b>CAUTION</b>	This symbol indicates the possibility of injury or damage to property.

■ The items to be followed are classified by the symbols:

	Symbol with background white denotes item that is PROHIBITED from doing.
-----------------------------------------------------------------------------------	--------------------------------------------------------------------------

 <b>WARNING</b>	
1) Engage dealer or specialist for installation. If installation done by the user is defective, it will cause water leakage, electrical shock fire.	
2) Install according to this installation instructions strictly. If installation is defective, it will cause water leakage, electrical shock fire.	
3) Use the attached accessories parts and specified parts for installation. otherwise, it will cause the set to fall, water leakage, electrical shock fire.	
4) Install at a strong and firm location which is able to withstand the set's weight. If the strength is not enough or installation is not properly done, the set will drop and cause injury.	
5) For electrical work, follow the local national wiring standard, regulation and this installation instructions. An independent circuit and single outlet must be used. If electrical circuit capacity is not enough or defect found in electrical work, it will cause electrical shock fire.	
6) Use the specified cable and connect tightly and clamp the cable so that no external force will be acted on the terminal. If connection or fixing is not perfect, it will cause heat-up or fire at the connection.	
7) Wiring routing must be properly arranged so that control board cover is fixed properly. If control board cover is not fixed perfectly, it will cause heat-up at connection point of terminal, fire or electrical shock.	
8) When carrying out piping connection, take care not to let air substances other than the specified refrigerant go into refrigeration cycle. Otherwise, it will cause lower capacity, abnormal high pressure in the refrigeration cycle, explosion and injury.	
9) Do not modify the length of the power supply cord or use of extension cord, and do not share the single outlet with other electrical appliances. Otherwise, it will cause fire or electrical shock.	
 <b>CAUTION</b>	
1) This equipment must be earthed and installed with earth leakage current breaker. It may cause electrical shock if grounding is not perfect.	
2) Do not install the unit at place where leakage of flammable gas may occur. In case gas leaks and accumulates at surrounding of the unit, it may cause fire.	
3) Carry out drainage piping as mentioned in installation instructions. If drainage is not perfect, water may enter the room and damage the furniture.	

## INSTALLATION INSTRUCTIONS

### Selecting installation place

Select an installation location which is rigid and strong enough to support or hold the unit, and select a location for easy maintenance. Read completely, then follow step by step.

#### Indoor unit

- Do not expose the indoor unit to heat or steam.
- Select a place where there are no obstacles in front or around the unit.
- Make sure that condensation drainage can be conveniently routed away.
- Do not install near a doorway.
- Ensure the spaces indicated by arrows from the wall ceiling or other obstacles.
- A place where noise prevention is taken into consideration.
- A place 1m or more to TV or radio instrument.
- A place where air circulation in the room is good.
- There should not be any direct sunlight. Otherwise, the sun will fade the plastic cabinet and affect its appearance. If unavoidable, sunlight prevention should be taken into consideration.

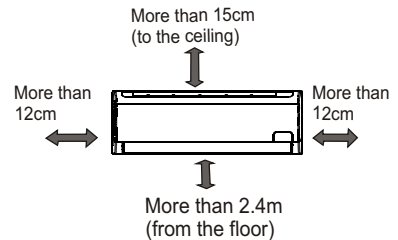

Fig.1

#### Outdoor unit

- If an awning is built over the outdoor unit to prevent direct sunlight or rain exposure, make sure that heat radiation from the condenser is not restricted.
- Keep the spaces indicated by arrows from wall or other obstacles.
- Do not place animals and plants in the path of the air inlet or outlet.
- Take the air conditioner weight into account and select a place where noise, vibration and hot air discharged will not be an issue.
- Do not install in a place full of machine oil or sulfide gas such as hot-spring resort.
- Do not install in a saline place such as coast.
- Do not install in a place where there are high frequency machines such as wireless equipment, welding machine or medical facility.

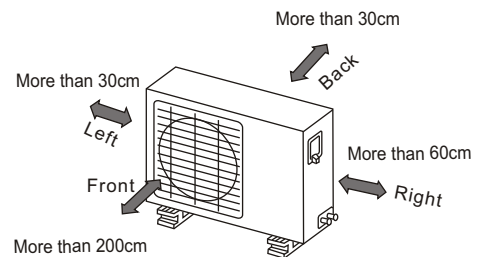

Fig.2

### Rooftop installation:

- If the outdoor unit is installed on a roof structure, be sure to level the unit.
- Ensure the roof structure and anchoring method are adequate for the unit location. Consult local codes regarding rooftop mounting.

### Tools needed for installation:

Level gauge  
Screwdriver  
Electric drill, Hole core drill ( $\phi$  65mm)  
Flaring tool set  
Specified torque wrenches: 1.8kgf.m,  
4.2kgf.m, 5.5kgf.m, 6.6kgf.m  
(different depending on model No.)  
Spanner (half union)

Hexagonal wrench (4mm)  
Gas-leak detector  
Vacuum pump  
Gauge manifold  
Users manual  
Thermometer  
Multimeter  
Pipe cutter  
Measuring tape

# INSTALLATION INSTRUCTIONS

## Accessories

Number	Name of Accessories		Q' ty
1	Installation Plate		1
2	Clip Anchor		5-8(depending on models)
3	Self-tapping Screw AST3.9X25		5-8(depending on models)
4	Seal(For cooling & heating modles only)		1
5	Drain Joint(For cooling & heating modles only)		1
6	Connecting pipe Assembly	Liquid side	Parts you must purchase. Consult the dealer about the pipe size.
	Gas side	$\Phi$ 9.53	
		$\Phi$ 12.7	
7	Remote controller		1
8	Self-tapping Screw B ST2.9X10	Optional parts	2
9	Remote controller holder		1

**Note:** Except the above parts provided, the other parts needed during installation you must purchase.

### CAUTION

- Use a stud finder to locate studs to prevent unnecessary damage to the wall.
- A minimum pipe run of 3 metres is required to minimise vibration & excessive noise.
- Two of the A, B and C directions should be free from obstructions.

- This illustration is for explanation purposes only.
- Copper lines must be insulated independently

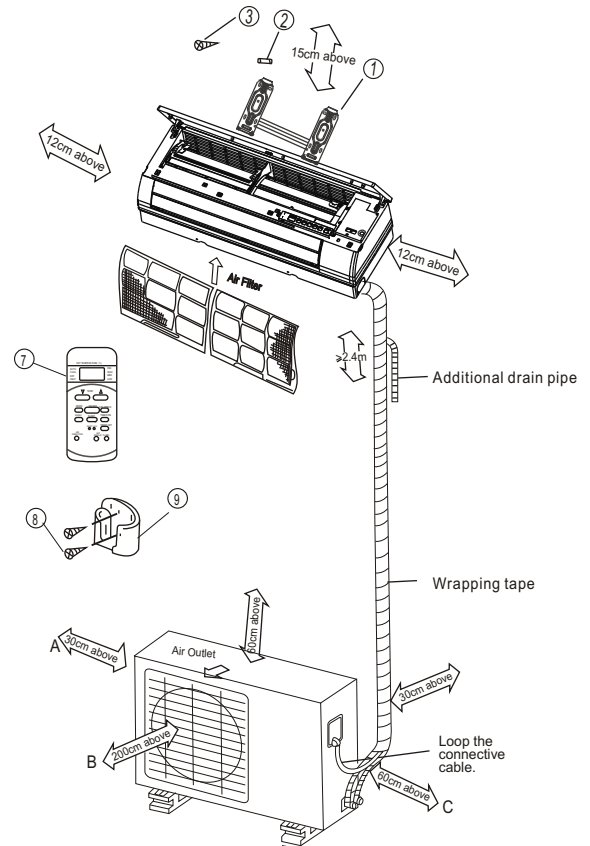

Fig.3

# INSTALLATION INSTRUCTIONS

## Indoor unit installation

### 1. Fit the Installation Plate

1. Fit the installation plate horizontally on structural parts of the wall with spaces around the installation plate.
2. If the wall is made of brick, concrete or the like, drill eight (8) 5mm diameter holes in the wall. Insert Clip anchor for appropriate mounting screws.
3. Fit the installation plate on the wall with eight (8) type "A" screws.

#### Note:

Fit the Installation Plate and drill holes in the wall according to the wall structure and corresponding mounting points on the installation plate. The installation plate provided with the machine is different according to the models.

(Dimensions are in "mm" unless otherwise stated)

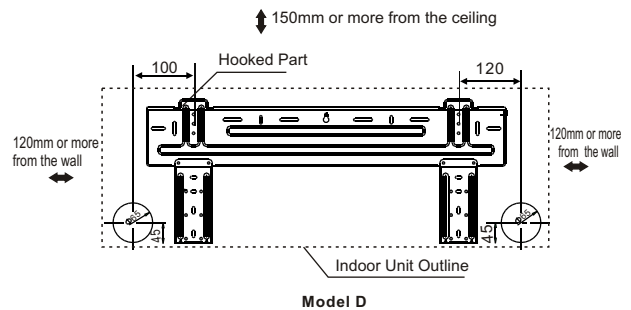
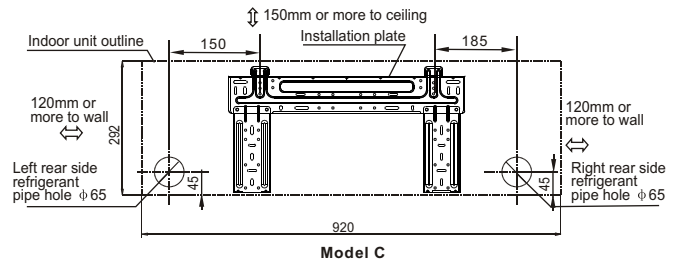
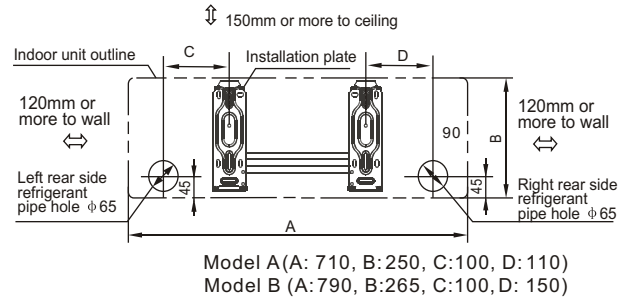
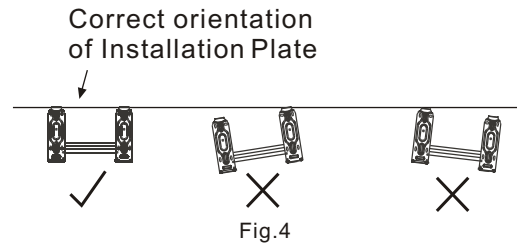
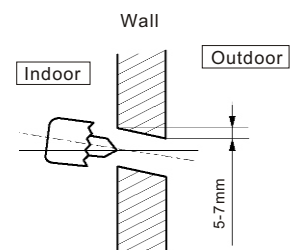

Fig.5

### 2. Drill a hole in the wall

1. Determine hole positions according to the diagram detailed in Fig.5. Drill one (1) hole ( $\phi 65$ mm) slanting slightly to outdoor side.
2. Always use wall hole conduit when drilling metal grid, metal plate or the like.



## INSTALLATION INSTRUCTIONS

### 3. Connective Pipe and Drainage Installation

#### Drainage

1. Run the drain hose sloping downward. Do not install the drain hose as illustrated in Fig.7.
2. When connecting extension drain hose, insulate the connecting part of extension drain hose with a shield pipe, do not let the drain hose slack.

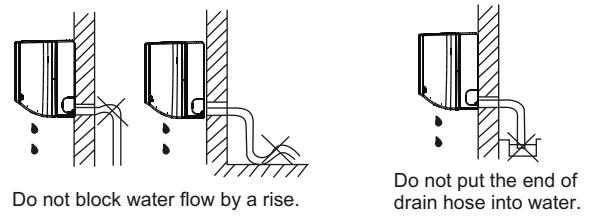

Fig.7

#### Connective pipe installation

1. For the left-hand and right-hand piping, remove the pipe cover from the side panel.
2. For the rear-right-hand and rear-left-hand piping, install the piping as shown.
3. Fix the end of the connective pipe. (Refer to Tightening Connection in REFRIGERANT PIPING CONNECTION)

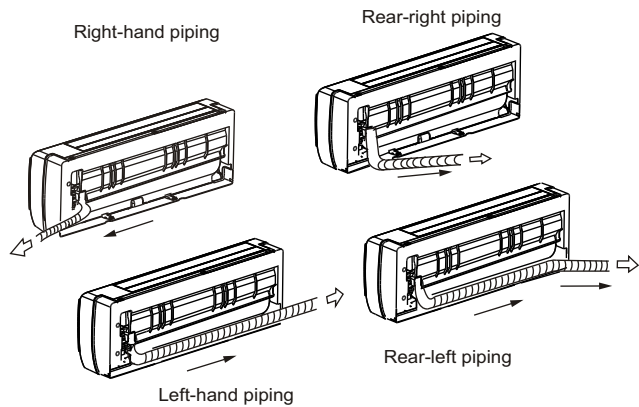

Fig.8

Fig.9

### 4. Indoor unit installation

1. Pass the piping through the hole in the wall.
2. Put the upper claw at the back of the indoor unit on the upper hook of the installation plate, move the indoor unit from side to side to see that it is securely hooked (see Fig.10 & Fig.11).
3. Piping can easily be made by lifting the indoor unit with a cushioning material between the indoor unit and the wall. Get it out after finish piping.
4. Push the lower part of the indoor unit up on the wall, then move the indoor unit from side to side, up and down to check if it is hooked securely.

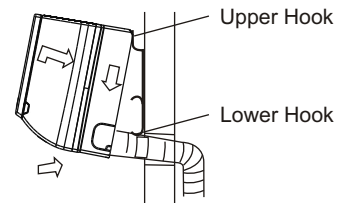

Fig.10

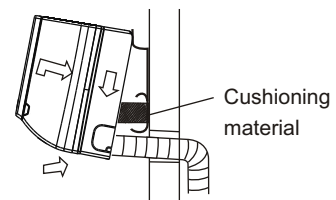

Fig.11

## INSTALLATION INSTRUCTIONS

### 5. Piping and wrapping

Bundle the tubing, connecting cable, and drain hose with tape securely, evenly as shown in Fig.12

- Because the condensed water from rear of the indoor unit is gathered in ponding box and is piped out of room. Do not put anything else in the box.

#### CAUTION

- Connect the indoor unit first, then the outdoor unit.
- Do not allow the piping to let out from the back of the indoor unit.
- Be careful not to let the drain hose slack.
- Heat insulated both of the auxiliary piping.
- Be sure that the drain hose is located at the lowest side of the bundle. Locating at the upper side can cause drain pan to overflow inside the unit.
- Never intercross nor intertwist the power wire with any other wiring.
- Run the drain hose sloped downward to drain out the condensed water smoothly.

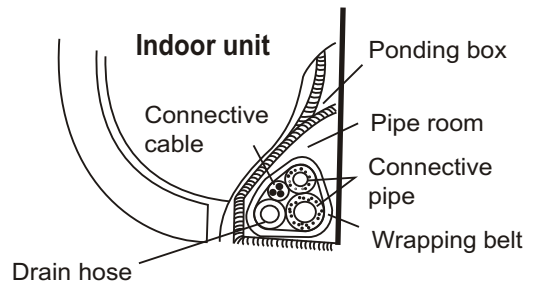

Fig.12

### Outdoor unit installation

#### Outdoor installation precaution

- Install the outdoor unit on a rigid base to prevent increasing noise level and vibration.
- Determine the air outlet direction where the discharged air is not blocked. In the case that the installation place is exposed to strong wind such as a seaside, make sure the fan operating properly by putting the unit lengthwise along the wall or using a dust or shield plates.
- Specially in windy area, install the unit to prevent the admission of wind. If need suspending installation, the installation bracket should accord with technique requirement in the installation bracket diagram.
- The installation wall should be solid brick, concrete or the same intensity construction, or actions to reinforce, damping supporting should be taken. The connection between bracket and wall, bracket and the air conditioner should be firm, stable and reliable.
- Be sure there is no obstacle which block radiating air.

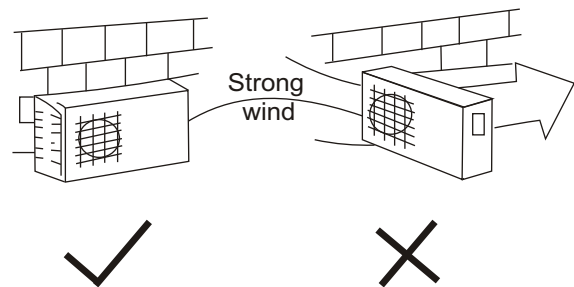

Fig.13

## REFRIGERANT PIPE CONNECTION

### Settlement of outdoor unit

- Anchor the outdoor unit with a bolt and nut  $\phi 10$  or  $\phi 8$  tightly and horizontally on a concrete or rigid mount.

Outdoor unit dimension mm(WxHxD)	Mounting dimensions	
	A(mm)	B(mm)
780x540x250	549	280
760x590x275	530	290
670x540x250	484	275
775x545x310	600	320
840x700x320	560	335
895x860x330	590	333

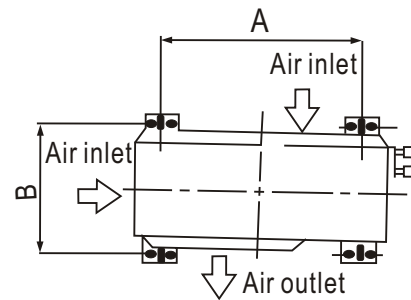

Fig. 14

### Drain joint installation

**NOTE:** The drain joint is slightly different according to the different outdoor unit.

For the drain joint with the seal (Fig. 15 (A)), first fit the seal onto the drain joint, then insert the drain joint into the base pan hole of outdoor unit, rotate  $90^\circ$  to securely assemble them. To install drain joint as shown in Fig. 15 (B), insert the drain joint into the base pan hole of outdoor unit until it remains fixed with a clicking sound. Connecting the drain joint with an extension drain hose (Locally purchased), in case of the water draining off the outdoor unit during the heating mode.

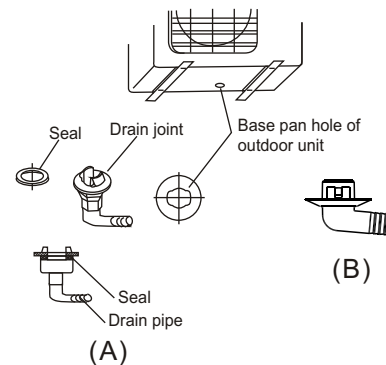

Fig. 15

## Refrigerant pipe connection

### 1. Flaring work

Main cause for refrigerant leakage is due to defect in the flaring work. Carry out correct flaring work using the following procedure:

#### A: Cut the pipes and the cable.

- Use the piping kit accessory or pipes purchased locally.
- Measure the distance between the indoor and the outdoor unit.
- Cut the pipes a little longer than the measured distance.
- Cut the cable 1.5m longer than the pipe length.

#### B: Burr removal

- Completely remove all burrs from the cut cross section of pipe/tube.
- Put the end of the copper tube/pipe in a downward direction as you remove burrs in order to avoid dropping burrs into the tubing.

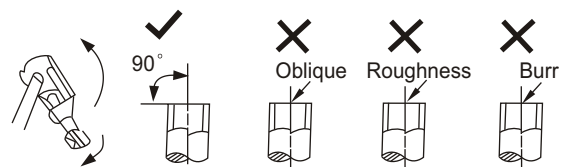

Fig. 16

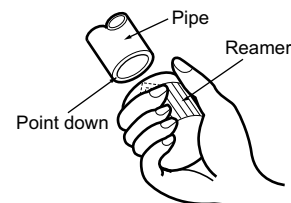

Fig. 17

## ELECTRICAL WORK

### C: Putting nut on

Remove flare nuts attached to indoor and outdoor unit, then put them on pipe/tube having completed burr removal. (not possible to put them on after flaring work)

### D: Flaring work

Firmly hold copper pipe in a die in the dimension shown in the table below.

Outer diam. (mm)	A(mm)	
	Max.	Min.
φ 6.35	1.3	0.7
φ 9.52	1.6	1.0
φ 12.7	1.8	1.0
φ 16	2.4	2.2

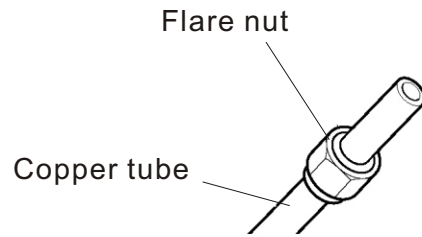

Fig.18

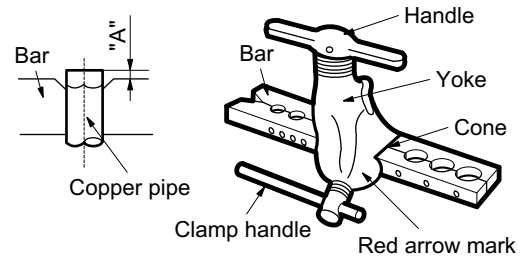

Fig.19

### Tightening Connection

- Align the center of the pipes.
- Sufficiently tighten the flare nut with fingers, and then tighten it with a spanner and torque wrench as shown in Fig.20 & 21.

Outer diam.	Tightening torque(N.cm)	Additional tightening torque(N.cm)
φ 6.35	1500 (153kgf.cm)	1600 (163kgf.cm)
φ 9.52	2500 (255kgf.cm)	2600 (265kgf.cm)
φ 12.7	3500 (357kgf.cm)	3600 (367kgf.cm)
φ 16	4500 (459kgf.cm)	4700 (479kgf.cm)

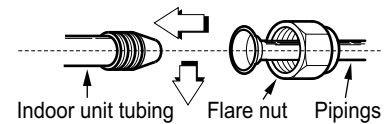

Fig.20

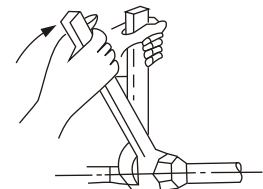

Fig.21

### Caution

- Excessive torque can break nut depending on installation conditions.

### Electrical work

Electric safety regulations for the initial Installation

1. If there is serious safety problem about the power supply, the technicians should refuse to install the air conditioner and explain to the client until the problem is solved.
2. Power voltage should be in the range of 90%~110%of rated voltage.
3. The creepage protector and main power switch with a 1.5 times capacity of Max. Current of the unit should be installed in power circuit.
4. Ensure the air conditioner is grounded well.
5. According to the attached Electrical Connection Diagram located on the panel of the outdoor unit to connect the wire.
6. All wiring must comply with local and national electrical codes and be installed by qualified and skilled electricians.
7. An individual branch circuit and single receptacle used only for this air conditioner must be available. See the following table for suggested wire sizes and fuse specifications:



## ELECTRICAL WORK

Minimum nominal cross-sectional area of conductors:

Rated current of appliance (A)	Nominal cross-sectional area (mm <sup>2</sup> )
>3 and ≤6	0.75
>6 and ≤10	1
>10 and ≤16	1.5
>16 and ≤25	2.5

**NOTE:** The cable size and the current of the fuse or switch are determined by the maximum current indicated on the nameplate which located on the side panel of the unit. Please refer to the nameplate before selecting the cable, fuse and switch.

### Connect the cable to the indoor unit

**NOTE:** Before performing any electrical work, turn off the main power to the system.

1. The inside and outside connecting cable can be connected without removing the front grille.
2. The indoor power cord type is H05VV-F or H05V2V2-F, the outdoor power cord and interconnected cord type is H07RN-F.
3. Lift the indoor unit panel up, remove the electrical box cover by loosening the screw as shown in Fig.22.
4. Ensure the colour of wires of outdoor unit and the terminal Nos. are the same to the indoor's respectively.
5. Wrap those cables not connected with terminals with insulation tapes, so that they will not touch any electrical components. Secure the cable onto the control board with the cord clamp.

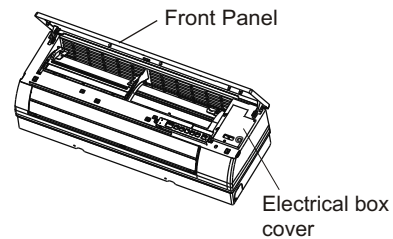

Terminal block of indoor unit

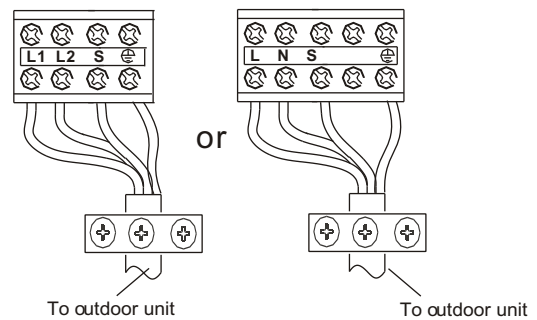

Fig.22

### Connect the cable to the outdoor unit

1. Remove the cover control from the unit by loosening the 3 screws. See Fig.23.
2. Dismount caps on the conduit panel.
3. Temporarily mount the conduit tubes(not included) on the conduit panel.
4. Properly connect both the power supply and low voltage lines to the corresponding terminals on the terminal block.
5. Ground the unit in accordance with local codes.
6. Be sure to size each wire allowing several inches longer than the required length for wiring.
7. Use lock nuts to secure the conduit tubes.

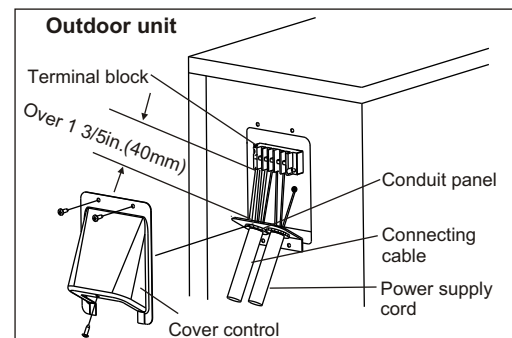
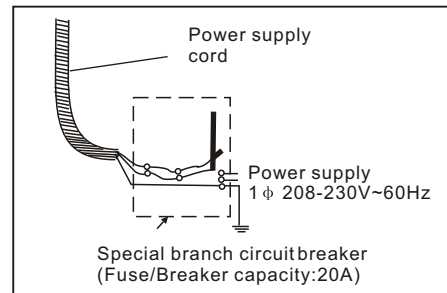

Fig.23a

## ELECTRICAL WORK

### Warning

- Be sure to comply with local codes while running the wire from the indoor unit to the outdoor unit.
- Every wire must be connected firmly.
- No wire should be allowed to touch refrigerant tubing, the compressor or any moving parts.
- Loose wiring may cause the terminal to overheat or result in unit malfunction.
- A fire hazard may also exist. Therefore, be sure all wiring is tightly connected.
- Disconnecting means must be provided and shall be located within sight from and readily accessible from the air conditioner.
- Connecting cable with conduit shall go through the hole of the conduit panel.



**Note :** To prevent wires loosening or leaving the Cord Clamp, please select proper cord diameter to fill the holes on the cord clamp.

### Terminal block of outdoor unit

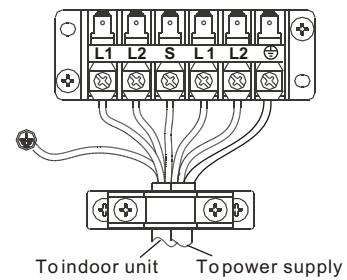

**(1)**

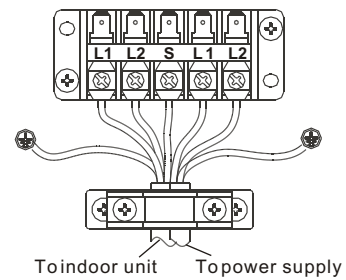

**(2)**

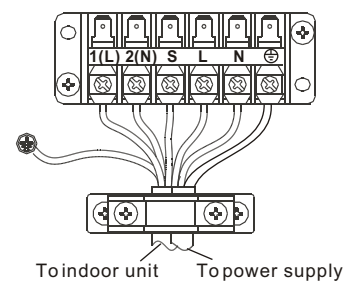

**(3)**

Fig.23b

## AIR PURGING

### CAUTION

After the confirmation of the above conditions, prepare the wiring as follows:

- 1) **Never fail to have an individual power circuit specifically for the air conditioner. As for the method of wiring, be guided by the circuit diagram posted on the inside of control cover.**
- 2) **The screw which fasten the wiring in the casing of electrical fittings are liable to come loose from vibrations to which the unit is subjected during the course of transportation. Check them and make sure that they are all tightly fastened. (If they are loose, it could cause burn-out of the wires.)**
- 3) **Specification of power source.**
- 4) **Confirm that electrical capacity is sufficient.**
- 5) **See to that the starting voltage is maintained at more than 90 percent of the rated voltage marked on the name plate.**
- 6) **Confirm that the cable thickness is as specified in the power source specification.**
- 7) **Always install an earth leakage circuit breaker in a wet or moist area.**
- 8) **The following would be caused by voltage drop.**

Vibration of a magnetic switch, which will damage the contact point, fuse breaking, disturbance of the normal function of the overload.

- 9) **The means for disconnection from a power supply shall be incorporated in the fixed wiring and have an air gap contact separation of at least 3mm in each active(phase) conductors.**

### Air purging

Air and moisture in the refrigerant system have undesirable effects as indicated below:

- Pressure in the system rises.
- Operating current rises.
- Cooling or heating efficiency drops.
- Moisture in the refrigerant circuit may freeze and block capillary tubing.
- Water may lead to corrosion of parts in the refrigeration system.

Therefore, the indoor unit and tubing between the indoor and outdoor unit must be leak tested and evacuated to remove any noncondensables and moisture from the system.

### Air purging with vacuum pump

- Preparation

Check that each tube(both liquid and gas side tubes) between the indoor and outdoor units have been properly connected and all wiring for the test run has been completed. Remove the service valve caps from both the gas and the liquid side on the outdoor unit. Note that both the liquid and the gas side service valves on the outdoor unit are kept closed at this stage.

- Pipe length and refrigerant amount:

Connective pipe length	Air purging method	Additional amount of refrigerant to be charged	
Less than 5m	Use vacuum pump.	_____	
More than 5m	Use vacuum pump.	Liquid side: $\phi$ 6.35 R22: (Pipe length-5)x30g/m R410A: (Pipe length-5)x20g/m	Liquid side: $\phi$ 9.53 R22: (Pipe length-5)x60g/m R410A: (Pipe length-5)x40g/m

- When relocate the unit to another place, perform evacuation using vacuum pump.
- Make sure the refrigerant added into the air conditioner is liquid form in any case.  
(Not applicable to the units adopt freon R22 )

### Caution in handling the packed valve

- Open the valve stem until it hits against the stopper. Do not try to open it further.
- Securely tighten the valve stem cap with a spanner or the like.
- Valve stem cap tightening torque (See Tightening torque table in previous page ).

### When Using the Vacuum Pump

(For method of using a manifold valve, refer to its operation manual.)

1. Completely tighten the flare nuts, A, B, C, D, connect the manifold valve charge hose to a charge port of the low-pressure valve on the gas pipe side.
2. Connect the charge hose connection to the vacuum pump.
3. Fully open the handle Lo of the manifold valve.
4. Operate the vacuum pump to evacuate. After starting evacuation, slightly loose the flare nut of the Lo valve on the gas pipe side and check that the air is entering (Operation noise of the vacuum pump changes and a compound meter indicates 0 instead of minus)
5. After the evacuation is complete, fully close the handle Lo of the manifold valve and stop the operation of the vacuum pump. Make evacuation for 15 minutes or more and check that the compound meter indicates -76cmHg (-1x10<sup>5</sup>Pa).
6. Turn the stem of the packed valve B about 45° counterclockwise for 6~7 seconds after the gas coming out, then tighten the flare nut again. Make sure the pressure display in the pressure indicator is a little higher than the atmosphere pressure.
7. Remove the charge hose from the Low pressure charge hose.
8. Fully open the packed valve stems B and A.
9. Securely tighten the cap of the packed valve.

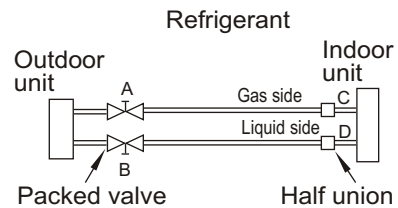

Fig.24

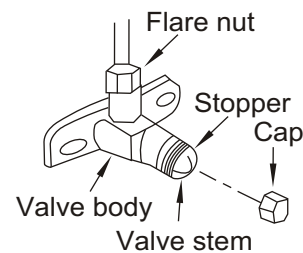

Fig.25

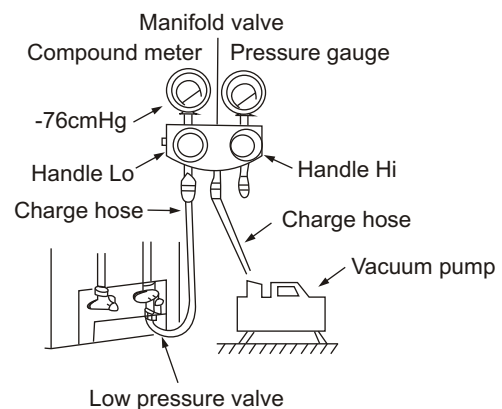

Fig.26

## TEST RUNNING

### Safety and leakage check

#### ● Electrical safety check

Perform the electric safe check after completing installation:

##### 1. Grounding work

After finishing grounding work, measure the grounding resistance by visual detection and grounding resistance tester. Make sure the grounding resistance is less than  $4 \Omega$ .

##### 2. Electrical leakage check (performing during test running)

During test operation after finishing installation, the serviceman can use the electroprobe and multimeter to perform the electrical leakage check. Turn off the unit immediately if leakage happens. Check and find out the solution ways till the unit operate properly.

#### ● Gas leak check

##### 1. Soap water method:

Apply a soap water or a liquid neutral detergent on the indoor unit connection or outdoor unit connections by a soft brush to check for leakage of the connecting points of the piping. If bubbles come out, the pipes have leakage.

##### 2. Leak detector

Use the leak detector to check for leakage.

### CAUTION

A: Lo packed valve B: Hi packed valve

C and D are ends of indoor unit connection.

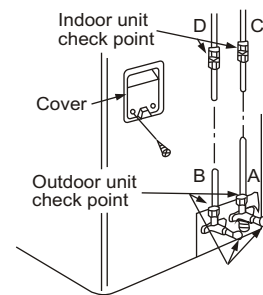
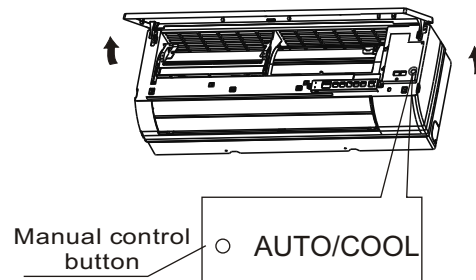

Fig.27

## Test running

Perform test operation after completing gas leak check at the flare nut connections and electrical safety check.

- Check that all tubing and wiring have been properly connected.
  - Check that the gas and liquid side service valves are fully open.
1. Connect the power, press the ON/OFF button on the remote controller to turn the unit on.
  2. Use the MODE button to select COOL, HEAT, AUTO and FAN to check if all the functions works well.
  3. When the ambient temperature is too low (lower than  $17^{\circ}\text{C}$ ), the unit cannot be controlled by the remote controller to run at cooling mode, manual operation can be taken. Manual operation is used only when the remote controller is disable or maintenance necessary.
    - Hold the panel sides and lift the panel up to an angle until it remains fixed with a clicking sound.
    - Press the Manual control button to select the AUTO or COOL, the unit will operate under Forced AUTO or COOL mode (see User Manual for details).
  4. The test operation should last about 30 minutes.



The design and specifications are subject to change without prior notice for product improvement. Consult with the sales agency or manufacturer for details.

**CS120I-BP9A1(LH)**