



ENGLISH

ESPAÑOL

USER'S GUIDE & INSTALLATION INSTRUCTIONS

CERAMIC-GLASS

INDUCTION COOKTOP

Please read this guide thoroughly before operating
and keep it handy for reference at all times.

LSCI307ST

INTRODUCTION

IMPORTANT SAFETY INFORMATION

Important Notice: Radio Interference.....	3
Important Safety Precautions	4-8

INTRODUCTION TO INDUCTION COOKING

Induction Cooking	9
Selecting Cookware.....	9-11

PARTS AND FEATURES

Parts and Features of Your Cooktop	12
Touch Control Features	13

OPERATING INSTRUCTIONS

Before Using the Cooktop	14
Setting the Controls.....	14-16
Using the Bridge Cooking Zones.....	17
Using the Timer	17
Using Child Lock.....	18
Other Functions	18

CARE AND CLEANING

Cleaning the Cooktop	19
----------------------------	----

INSTALLATION INSTRUCTIONS

Before You Begin.....	20
Unpacking the Cooktop	20
Technical Specifications	20
Preparing the Installation Location	21
Dimensions and Clearances.....	22
Electrical Connections	23-25
Cooktop Installaton.....	25, 26
Final Check.....	26

TROUBLESHOOTING

Before Calling for Service	27,28
----------------------------------	-------

WARRANTY

Warranty for customers in the U.S.A.	29
Warranty for customers in Canada	30

THANK YOU!

Congratulations on your purchase
and welcome to the LG family.

Your new LG RADIANT Cooktop
combines precision cooking
features with simple operation
and stylish design. By following
the operating and care instructions
in this manual, your cooktop will
provide you with many years of
reliable service.

Product Registration Information

Model: _____

Serial Number: _____

Date of Purchase: _____

IMPORTANT SAFETY INFORMATION

READ ALL INSTRUCTIONS BEFORE USE

⚠️ WARNING For your safety, the information in this manual must be followed to minimize the risk of fire, electric shock, or to prevent property damage, personal injury, or death.

IMPORTANT NOTICE: RADIO INTERFERENCE

This unit has been tested and found to comply with the limits for a class B digital device, pursuant to Part 18 of the FCC rules. These limits are designed to provide reasonable protection against harmful interference in a residential installation. This unit generates, uses and can radiate radio frequency energy and, if not installed and used in accordance with the instructions, may cause harmful interference to radio communications. However there is no guarantee that interference will not occur in a particular installation. If this unit does cause harmful interference to radio or

television reception, which can be determined by turning the unit off and on, the user is encouraged to try to correct the interference by one or more of the following measures:

- Reorient or relocate the radio and/or television receiving antennae.
- Increase the distance between the cooktop unit and radio or television receiver.
- Connect the cooktop unit into an outlet or a circuit different from that to which the radio or television receiver is connected.

IMPORTANT SAFETY NOTICE

The California Safe Drinking Water and Toxic Enforcement Act requires the Governor of California to publish a list of substances known to the state to cause birth defects or other

reproductive harm and requires businesses to warn customers of potential exposure to such substances.

IMPORTANT SAFETY INFORMATION

READ ALL INSTRUCTIONS BEFORE USE

SAFETY PRECAUTIONS

- **Proper Installation:** Be sure your appliance is properly installed and grounded by a qualified technician in accordance with the National Electrical Code ANSI/NFPA No. 70, latest edition in the United States, and all local code requirements. Install only per installation instructions.
- Do not attempt to repair or replace any part of your cooktop unless it is specifically recommended in this manual. All other service should be referred to a qualified technician.
- Remove all tape and packaging wrap before using the appliance. Destroy the carton and plastic bags after unpacking the appliance. Never allow children to play with packaging material.
- The safety aspects of this appliance comply with accepted technical standards.
- **Know how to disconnect the electrical power to the appliance at the circuit breaker or fuse box in case of an emergency.** Mark the breaker or fuse for ease of identification and swift action if necessary.
- **Do not repair or replace any part of the appliance.** All servicing should be done only by a qualified technician to avoid the risk of personal injury and damage to the appliance.
- **Never modify or alter the construction of an appliance such as removal of panels, wire covers or any other permanent part of the product.**
- **Storage on appliance: Flammable materials should not be stored near or on the cooking surface.** This includes paper, plastic and cloth items, such as cookbooks, plasticware and towels, as well as flammable liquids. Do not store explosives, such as aerosol cans, on or near the appliance. Flammable materials may explode and result in fire or property damage.
- **Do not leave children alone. Children should not be left alone or unattended in the area where an appliance is in use.** They should never be allowed to sit or stand on any part of the appliance.
- **Do not store or use gasoline or other flammable vapors and liquids in the vicinity of this or any other appliance.**

CAUTION

Items of interest to children should not be stored in cabinets above a cooktop or on the backsplash of a cooktop—children climbing on the cooktop to reach items could be seriously injured.

WARNING

Never use your appliance for warming or heating a room.

WARNING

Persons with a pacemaker or similar medical device should exercise caution using or standing near an induction unit while it is in operation, as the electromagnetic field may affect the working of the pacemaker or similar medical device. It would be advisable to consult your doctor or the pacemaker or similar medical device manufacturer about your particular situation.

CAUTION

DO NOT touch Cooking Zones or areas near these surfaces. Cooking Zones may be hot from residual heat even though they are dark in color. Areas near the Cooking Zones may become hot enough to cause burns. During and after use, do not touch or let clothing or other flammable materials touch these areas until they have had sufficient time to cool.

IMPORTANT SAFETY INFORMATION

READ ALL INSTRUCTIONS BEFORE USE

SAFETY PRECAUTIONS (cont.)

- **Wear proper apparel. Loose-fitting or hanging garments should never be worn while using the appliance.** Do not let clothing or other flammable materials contact hot surfaces.
- **Do not use water or flour on grease fires.** Smother the fire with a pan lid, or use baking soda, a dry chemical or foam-type extinguisher.
- **When heating fat or grease, watch it closely.** Fat or grease may catch fire if allowed to become too hot.
- **Use only dry pot holders.** Moist or damp pot holders on hot surfaces may result in burns from steam. Do not let the pot holders touch hot surface units. Do not use a towel or other bulky cloth instead of a pot holder.
- **Do not heat unopened food containers.** Buildup of pressure may cause the container to burst and result in injury.

ELECTRICAL SAFETY

WARNING

- **If the surface is cracked, switch off the appliance to avoid the possibility of electric shock. Do not reuse your COOKTOP until the glass surface has been changed.**
- **When using the COOKTOP, never use aluminum foil, products wrapped in aluminum foil, or deep-frozen food in aluminum cookware.**
- **If the supply cord is damaged, it must be replaced by the manufacturer, its service agent or similarly qualified persons in order to avoid a hazard.**

- The installation and connection of the new appliance must only be carried out by qualified personnel.
- Flush-mounted appliances may only be operated following installation in suitable cabinets and workplaces which conform to the relevant standards. This ensures sufficient protection against electric shock as required by certification agencies.
- If your appliance malfunctions or fractures, switch off all cooking zones, and contact Service Center.

CHILD SAFETY

WARNING

- **This appliance is not intended for use by young children or infirm persons unless they have been adequately supervised by a responsible person to ensure that they can use the appliance safely.**
- **Young children should be supervised to ensure that they do not play with the appliance.**
- **Accessible parts may become hot during use. Young children should be kept away.**

IMPORTANT SAFETY INFORMATION

READ ALL INSTRUCTIONS BEFORE USE

SAFETY DURING USE

- **This appliance may only be used for normal cooking and frying in the home.** It is not designed for commercial or industrial purposes.
- **Do not use the cooktop to heat the room.**
- **Take care when plugging in electric appliances near the cooktop.** Cords must not come into contact with the hot surface. This could cause damage to the cooktop and cable insulation.
- **Overheated fats and oils catch fire quickly.** You should supervise cooking when preparing foods in fat or oil.
- **After use, switch off the hob element by its control and do not rely on the pan detector.**
- **Always keep the control panels clean and dry.** Do not let liquids or grease remain on the cooktop controls area. Spilled or burnt-on foods can activate or deactivate the appliance. Clean the controls area thoroughly to resume normal operation of the appliance.
- **Never place combustible items on the cooktop.**
- **Never keep any combustible items or aerosol cans in a drawer located under the cooktop.**
- **Avoid placing metal cooking utensils on the cooking surface areas.** Metal objects can become hot and cause burns.
- **Know which touch keypad controls each surface of the cooking zones.**
- **Clean the appliance regularly to keep all parts free of grease that could catch fire.** Exhaust fan ventilation hoods and grease filters should be kept clean. Do not allow grease to accumulate on hood or filter. Greasy deposits in the fan could catch fire. Refer to hood manufacturer's instructions for cleaning.
- **Use proper pan size.** This appliance is equipped with one or more Cooking Zones of different sizes.
- **Select utensils having flat bottoms large enough to cover the Cooking Zones.** The pan detection sensors will not allow the affected cooking zones to operate without a pan present.
- **Do not place any object on or near the control keypad area in order to prevent accidental activation of the cooktop controls.**
- **Utensil handles should be turned inward and should not extend over adjacent cooking zones** to reduce the risk of burns, ignition of flammable materials, and spillage due to unintentional contact with the utensil.
- **Never leave prepared food on the Cooking Zones.** Boilovers cause smoking and greasy spillovers that may ignite, or a pan that has boiled dry may melt or become damaged.
- **Protective liners: Do not use aluminum foil to line any part of the cooktop.** Only use aluminum foil as recommended after the cooking process, if used as a cover to be placed over the food. Any other use of aluminum foil may result in the risk of electric shock, fire or short circuit.
- **Glazed cooking utensils: Only certain types of glass, glass/ceramic, ceramic, earthenware, or other glazed utensils are suitable for rangetop service without breaking due to the sudden change in temperature.** Check the manufacturer's recommendations for cooktop use.
- **Ventilating hood: The ventilating hood above your cooking surface should be cleaned frequently, so the grease from cooking vapors does not accumulate on the hood or filter.**
- **Do not clean or operate a broken cooktop.** If cooktop should break, cleaning solutions and spillovers may penetrate the broken cooktop and create a risk of electric shock. Contact a qualified technician immediately.
- **Clean cooktop with caution.** If a wet sponge or cloth is used to wipe spills on a hot cooking area, be careful to avoid a steam burn. Some cleaners can produce harmful fumes if applied to a hot surface.

IMPORTANT SAFETY INFORMATION

READ ALL INSTRUCTIONS BEFORE USE

SAFETY DURING USE (cont.)

- **Do not place hot cookware on cold cooktop glass.** This could cause glass to break.
- **Do not slide pans across the cooktop surface.** They may scratch the cooktop surface.
- **Do not let pans boil dry.** This may cause permanent damage in the form of breakage, fusion, or marking that can affect the ceramicglass cooktop. (This type of damage is not covered by your warranty.)
- **Never leave surface units unattended at high heat settings.** Boilover causes smoking and greasy spillovers that may ignite.

CAUTION

DO NOT pick up the supplied bridge pan handles after cooking. They might be hot and there is a risk of burning yourself.

SAFETY WHEN CLEANING

- **Always switch off the appliance before cleaning.**
- **For safety reasons, do not clean the appliance with a steam jet or high-pressure cleaner.**
- **Clean the cooktop in accordance with the maintenance and cleaning instructions in this manual.**
- **Steam cleaner is not to be used for cleaning of the cooktop.**
- **Do not use harsh abrasive cleaners or rough metal scrapers to clean the cooktop glass since they can scratch the surface, which may result in shattering of the glass.**

COOK MEAT AND POULTRY THOROUGHLY

Cook meat and poultry thoroughly—meat to at least an INTERNAL temperature of 160°F and poultry to at least an INTERNAL temperature of 180°F. Cooking to these temperatures usually protects against foodborne illness.

IMPORTANT SAFETY INFORMATION

READ ALL INSTRUCTIONS BEFORE USE

HOW TO AVOID DAMAGE TO THE APPLIANCE

- Prior to using your cooktop for the first time, apply the recommended cooktop cleaning creme to the ceramic surface. Buff with a non-abrasive cloth or pad. This will make cleaning easier when soiled from cooking. The special cooktop cleaning cream leaves a protective finish on the glass to help prevent scratches and abrasions.
- Do not use the cooktop as a worksurface or storage space.
- Please be careful at the edges when moving pots and pans around.
- Do not have the cooking zones on with empty pans, or with no pots or pans on them.
- Ceramic glass is very tough, and impervious to sharp temperature changes but is not unbreakable. It can be damaged if particularly hard or sharp objects fall onto it.
- Be very cautious if using pots made of cast iron, or other pots with rough edges or burrs. Moving these can cause scratches on glass.
- If sugar or a mixture containing sugar falls onto a hot cooking zone and melts, remove immediately, while still hot. If left to cool down, it may damage the surface when removed.
NOTE: There is a risk of burning yourself when the glass scraper is used on a hot cooking zone!
- Keep meltable objects or materials away from the ceramic glass surface, for example, plastic utensils, aluminum foil, or cooking wraps. If any materials or foodstuffs melt on the ceramic-glass surface, these should be cleaned up immediately.

DISPOSAL OF OLD APPLIANCES

To protect the environment, it is important that worn-out appliances are disposed of in the correct manner.

- The appliance must not be disposed of with household rubbish.
- You can obtain information about collection dates or public refuse disposal sites from your local health council or environmental health office.

CAUTION

Before disposing of old appliances please make them inoperable so they cannot be a source of danger. To do this, have a qualified person disconnect the appliance from the house circuitry.

**READ AND FOLLOW THIS SAFETY INFORMATION CAREFULLY.
SAVE THESE INSTRUCTIONS**

INTRODUCTION TO INDUCTION COOKING

INDUCTION COOKING

HOW INDUCTION COOKING WORKS

An induction coil is beneath the ceramic glass cooking surface. This generates magnetic fields, which act directly on the base of the pots and pans as compared to methods that first heat the ceramic glass. This means that the base of the pan is immediately heated up, saving time and energy. Since the heat required for cooking is generated directly in the base of the pan, the Cooking Zone itself warms up only slightly. The cooktop becomes hot from the heat from the base of the pan.

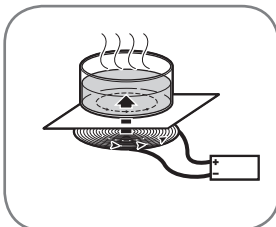

NOTE: If there is no pot or pan on the cooking zone, there is no energy transfer (heating up). This prevents the Cooking Zones being switched on and becoming hot accidentally.

IMPORTANT:

- Remove all tape and packaging wrap before using the appliance. Destroy the carton and plastic bags after unpacking the appliance. Never allow children to play with packaging materials.
- Electromagnetic fields can affect electronic circuits and interfere with portable radios and phones.
- Do not put magnetically active objects (e.g., credit cards, computer diskettes, cassettes) on or near the ceramic glass surface while one or more induction cooking zones are in use!
- Do not put any metallic objects (e.g., spoons, pan lids) on the Cooking Zones as they can become hot when the Cooking Zones are in use.

SELECTING COOKWARE

The magnetic Cooking Zone sensors located below the cooktop surface require the use of cookware made with magnetic material in order to start the heating process on any of the Cooking Zones. When purchasing pans, look for cookware specifically labeled by the manufacturer for use with induction cooktops.

POTS AND PANS

- In principle, all pots and pans with magnetic bases are suitable. These include steel, steelenamel, as well as cast-iron pots and pans.
- High grade steel pans with a mixed metal base (sandwich base, e.g. Tefal® with an aluminum/copper base) are suitable for induction only if the manufacturer has expressly marked them as such. In that case they have a magnetic material in the base.
- If you wish to use a special type of pan (e.g., a pressure cooker, simmering pan, wok), please follow the manufacturer's instructions and do not use a very thin pan.

NOTE: Some cookware can produce noises when used on induction cooking zones. This is not a fault in the cooktop, and its function will not be impaired in any way as a result.

SUITABILITY TEST:

If you are not sure if a pot or pan is suitable for use with your induction cooktop, you can find out with a few simple tests:

- Place a pot filled with a little water (1/8"–1/4") on the Cooking Zone. Set the Cooking Zone to full power (power level 9).

CAUTION

The pan base of suitable kitchenware heats up within a few seconds! Water should boil rapidly.

- You can also check cookware suitability with a magnet. If the magnet remains fixed to the base of the pan, the pan is suitable for induction cooking.

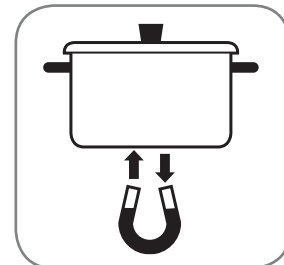

INTRODUCTION TO INDUCTION COOKING

SELECTING COOKWARE (continued)

AVOIDING SCRATCHES

It is recommended to always use heavier gauge stainless steel cookware on your induction cooktop surface. This will help reduce the possibility of developing scratches on the ceramic surface. Low-quality cookware can scratch the cooktop surface. Cookware should always be lifted over the ceramic cooktop surface to prevent scratching. Sliding any type of cookware over the ceramic cooktop can affect the overall appearance of the cooktop. Over time, sliding ANY type of cookware over the ceramic cooktop may alter the overall appearance of the cooktop. Eventually, the buildup of scratches can make cleaning the surface difficult and degrade the overall appearance of the cooktop. Scratches can also result from grains of sand (e.g., after washing vegetables) which are dragged with the pot across the cooking surface.

FOR BEST RESULTS:

Always follow the recommendations for proper cookware type and size. In addition:

- Do not use dirty pans with grease buildup. Always use pans that are easy to clean after cooking, and make sure that the bottoms of the pans are clean and dry.
- When cooking with large amounts of liquid, use large pots so that nothing can boil over.
- Do not let pans boil dry. This may cause permanent damage in the form of breakage, fusion, or marring that can affect the ceramic cooktop. (This type of damage is not covered by your warranty.)
- Match the pan size and Cooking Zone to the amount of food being prepared.

USE FLAT-BOTTOMED COOKWARE

Cookware must fully contact the surface of the cooking element. Use flat-bottomed pans sized to fit the cooking element and amount of food being prepared. Check for flatness by rotating a ruler across the bottom of the cookware.

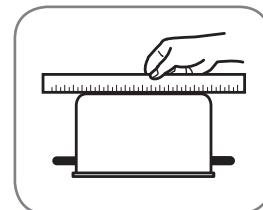

TIPS FOR SAVING ENERGY:

- Always position pots and pans before you switch on the Cooking Zone.
- Dirty cooking zones and cookware use more electricity.
- Whenever possible, always have the lid firmly placed on the pots and pans so that they are completely covered.

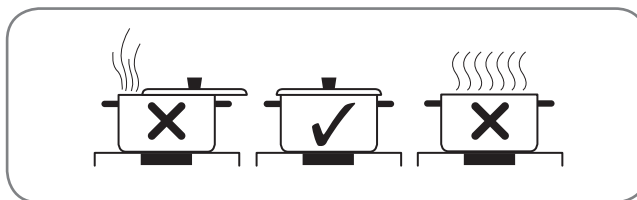

INTRODUCTION TO INDUCTION COOKING

SELECTING COOKWARE

SELECTING THE PROPER PAN SIZE

- There are 4 Cooking Zones on the induction cooktop. Each element requires a minimum pan size to be used effectively. The inner ring of each cooking zone is a guide to correctly match the minimum pan size. The bottom of the pan must fully cover the inner ring for proper cooking to occur.
- The thicker outer ring at each Cooking Zone is helpful to determine the pan MAXIMUM size. After centering the cookware on the Cooking Zone, make sure the cookware does not extend more than 1/2" beyond the thicker line on the Cooking Zone. The pan must make FULL contact on the glass surface without the bottom of the pan touching the metal cooktop trim.

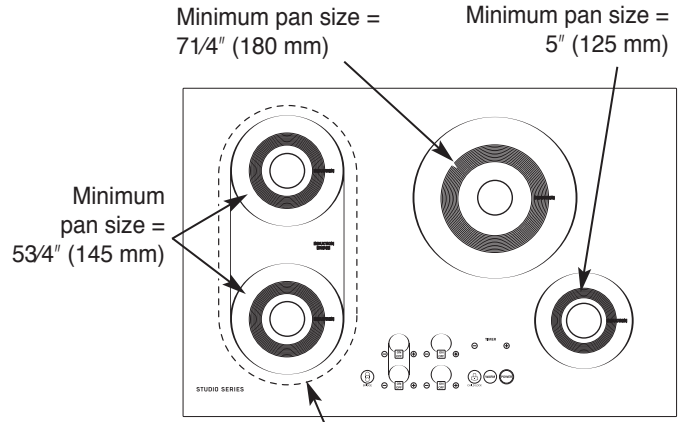

Only use the supplied pan on the bridge element.



If a pan made of the correct material is centered properly on any of the active Cooking Zones but is TOO SMALL, the affected Cooking Zone LED will blink and the pan will not heat.

COOKWARE SELECTION AND PLACEMENT

It is important that the proper cookware be used and placed correctly on the cooktop. ANY one of the incorrect conditions shown below may be detected by the sensors located below the ceramic cooktop surface. If this happens, one or more of the Cooking Zones will not heat, and an F will appear in the affected Cooking Zone display. Correct the problem before attempting to use the cooktop.

CORRECT



Cookware centered correctly on Cooking Zone surface.



Flat pan bottom & straight sides.



Pan size meets or exceeds the recommended minimum size for the Cooking Zone.



Pan rests completely on the cooktop surface.



Pan is properly balanced.

INCORRECT



Cookware not centered on Cooking Zone surface.

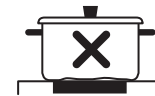

Cookware not centered on Cooking Zone surface.

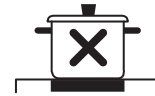

Pan does not meet the minimum size required for the Cooking Zone used.

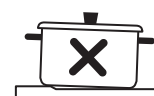

Pan bottom rests on cooktop trim or does not rest completely on the cooktop surface.



Heavy handle tilts pan.

PARTS AND FEATURES

PARTS AND FEATURES OF YOUR COOKTOP

Throughout this manual, features and appearance may vary from your model.

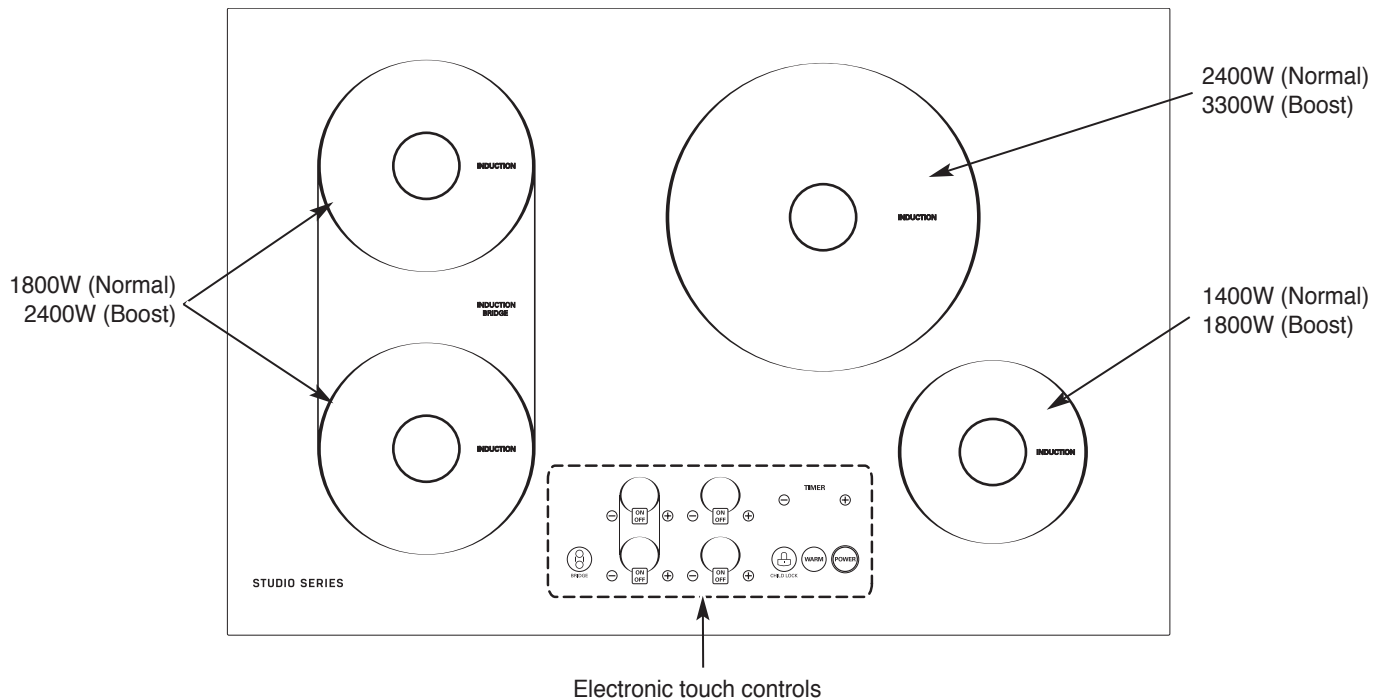

Ceramic Cooktop: LG's new induction cooktop features a ceramic cooktop surface that remains cooler than conventional ceramic cooktops, regardless of whether it is ON or OFF.

CAUTION

Burn Hazard: The Cooking Zones may appear cool when turned ON and after they have been turned OFF. The ceramic surface may be HOT from residual heat transferred from cookware.

Magnetic Detector: The coil sensor automatically detects suitable cookware and prevents accidental activation.

Pan Size Detection: The pan recognition sensor automatically detects and adapts the Cooking Zones to the pan size being used.

Improved Efficiency: Induction cooking heats faster while using less energy. Induction cooking brings liquids to a boil quickly yet allows even, steady simmering.

Induction Cooking Zones: Induction Cooking Zones under the ceramic cooktop heat the base of the pan immediately without heating the ceramic-glass cooktop first. The two medium-sized zones can be used together for larger oblong pans.

Touch Controls: Easy-to-use touch controls provide precise operation.

Easy Cleaning: The ceramic-glass cooking surface and touch control make for easy cleanup and eliminate crevices and gaps where grease can accumulate.

Control and Function Displays: Digital displays show current settings and warn you of hot surfaces from any residual heat of the corresponding cooking zone.

Safety Shutoff: All Cooking Zones feature a safety shut off that turns off the Cooking Zone if ON/OFF is pressed but no power level is selected within 10 seconds.

TOUCH CONTROL FEATURES

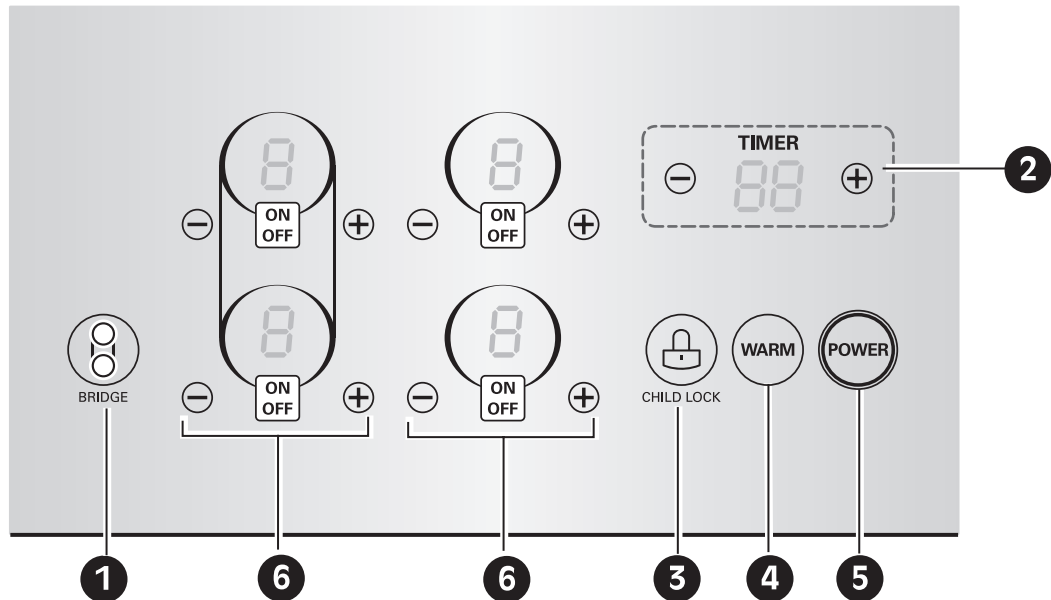

- 1 BRIDGE:** Activates the two left Cooking Zones together as a single large Cooking Zone. For bridge operation, touch this pad to activate and adjust the power level with the **+** or **-** pads for either left Cooking Zone.
- 2 TIMER:** When activated, the time remaining is shown in the display. Use the **+** or **-** pads to adjust the timer.
- 3 CHILD LOCK:** Press and hold for 3 seconds to activate and deactivate the child lockout function.
- 4 WARM:** This pad automatically lowers the last selected active element to the lowest setting.
- 5 POWER:** Press the POWER pad to turn the entire cooktop ON and OFF. When it is ON, the cooktop is in standby mode until a Cooking Zone is activated.
- 6 COOKING ZONE CONTROLS:** Each Cooking Zone features its own control, and can be activated individually.
- ON/OFF** The **ON/OFF** pad activates the desired Cooking Zone.
- Use the **+** or **-** pads for the active Cooking Zone to adjust the power level from **0** to **9** and **P** (Boost).
- The display in the Cooking Zone control will show the power level:
- 0** to **9** or **P**
- Hot Surface Indicator:** After use, an **H** will appear in the Cooking Zone power level display until the cooking surface has cooled down.

OPERATING INSTRUCTIONS

BEFORE USING THE COOKTOP

Before using the cooktop for the first time, clean it thoroughly with the included cleaner or ceramic cooktop cleaner according to the Care and Cleaning instructions in this guide. This will remove any help protect the ceramic surface and make future cleanup easier.

CAUTION

Never use scrub pads or abrasive cleaners. They can cause permanent damage to the cooktop surface.

SETTING THE CONTROLS

To operate the touch control pads, touch the pad firmly with the flat part of your fingertip.

FIRST OPERATION

The first time that power is supplied to the cooktop, **H** will flash in the display for each cooking zone for 60 seconds or until the POWER pad is touched for approximately 2 seconds.

NOTE: **H** will also flash when power is restored after a power outage.

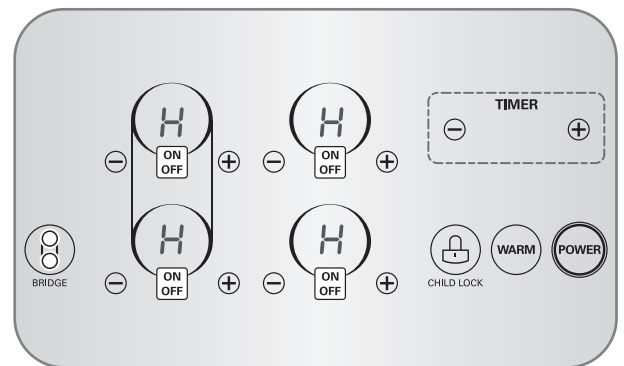

ACTIVATING THE COOKTOP



To turn on the cooktop, touch the POWER pad for approximately 2 seconds. The indicator above the pad will light.

NOTE: After turning on the cooktop with the POWER pad, you must select one of the Cooking Zones within 20 seconds using the Cooking Zone ON/OFF pad(s). If no selection is made, the cooktop will turn off for safety reasons.

SELECTING THE COOKING ZONE



To select the desired Cooking Zone, press the ON/OFF pad. The display for the selected Cooking Zone will show **1** and an indicator will light to indicate that the Cooking Zone is on but no power level is set.

NOTE: Once the Cooking Zone has been selected with the ON/OFF pad, the power level must be selected within 5 seconds with the **+** or **-** pad. Otherwise, the Cooking Zone will turn off for safety reasons.

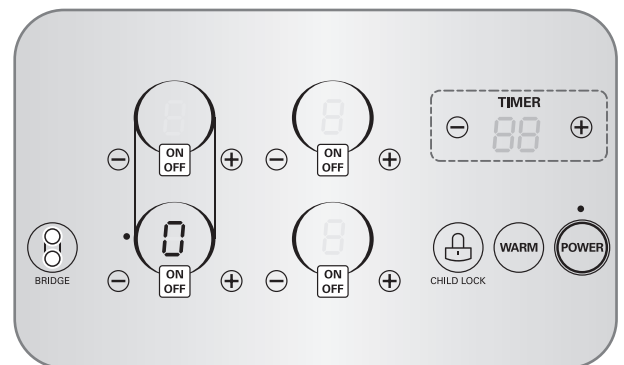

SETTING THE CONTROLS

SETTING THE POWER LEVEL

The power level for the selected Cooking Zone can be set from **1** to **9** and **P** (Boost).

To adjust the power level:

- 1 Touch the **+** or **-** pad for the selected Cooking Zone.
Touching **-** will set the power level to **3**.
Touching **+** will set the power level to **9**.
Touch the **+** or **-** pad of the selected Cooking Zone to increase or decrease the power level.
If power level **1** is selected, the Cooking Zone will turn off after 5 seconds.
- 2 For faster power level adjustments, touch and hold the **+** or **-** pads until the desired setting is reached.

NOTE: Normal power settings range in 1/2 step increments for power levels from 2 to 6 to allow precision cooking. A dot will appear next to the number to indicate a 1/2 power level step.

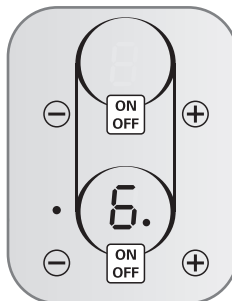

- 3 If the Cooking Zone **+** or **-** pads are held for more than 10 seconds, the timer display will show the error message **E1**. To clear this error message, press the ON/OFF pad for the Cooking Zone you were setting. This message does NOT relate to the timer pad.

To turn off the cooking zone:

- 1 Once cooking is complete, touch the ON/OFF pad to turn the cooking zone OFF.
- 2 The corresponding cooking zone display will turn off.
- 3 If the POWER pad is touched instead of ON/OFF, the entire cooktop will turn off.

NOTE:

- If the cookware or pan is moved from the center of any active Cooking Zone for any reason, a sensor will detect this and the Cooking Zone will no longer heat. The display for that Cooking Zone will flash the last power level setting for the Cooking Zone.
- The Cooking Zone will remember the power level setting for up to 90 seconds before the Cooking Zone will automatically shut off.

! WARNING

Your cooktop has a residual heat indicator **H** for each Cooking Zone. This indicator will warn that this area has been used and is still giving off enough heat to cause burns. Avoid touching the burner when this indicator is shown. Although the cooktop is OFF, the **H** will stay lit until the cooktop has cooled down.

OPERATING INSTRUCTIONS



SETTING THE CONTROLS (cont.)



POWER BOOST

Boost is the highest power level, designed for quickly heating or boiling larger quantities. Boost will operate for a maximum of 12 minutes. After 12 minutes, it will automatically revert to power level 9.

ACTIVATING POWER BOOST

1 Turn on the desired Cooking Zone with the ON/OFF pad for that Cooking Zone.

2 Touch the  pad and  will be displayed.

3 Touch the  pad again and  will be displayed.

NOTE: The power boost function will be activated for a maximum of 12 minutes. At the end of the power boost cycle, the Cooking Zone will automatically default to the back to the power level . The power boost function CANNOT be used with the front and rear Cooking Zones on the same side at the same time.

4 To deactivate the power boost function and revert to normal power levels, touch the  pad.

NOTE: To protect the internal electronic components of the cooktop, the cooktop may automatically deactivate the power boost function and return to a normal power level before 12 minutes have passed. This is normal.

NOTE: The electronic processes involved with induction cooking create some unusual background noises. These noises are normal and part of the induction cooking process. Please note that these noises are more noticeable while cooking with power boost.



WARM

The cooktop features a WARM setting that operates the last Cooking Zone used at the LOW power level.

To activate:

Touch the WARM pad and the last Cooking Zone used will be set to the LOW setting.  will appear in the display.

To deactivate:

To turn off the WARM function and return to normal power levels, touch the  pad and  will be displayed.

POWER LEVEL GUIDE

Setting	Function	Used for
9 or Boost	Fast heating	Bringing liquids to a boil.
7-9	Heaving browning, deep fat frying	Browning meats, heating oil for deep-fat frying, sautéing, maintaining a fast boil for large amounts of liquids.
6-7	Roasting, frying	Frying meats, chops, pancakes, sausages, eggs.
4-5	Boiling, general cooking	Cooking larger quantities, soups and stews, steaming potatoes, cooking meat stock or bouillon.
3-4	Steaming	Steaming vegetables, braising meats.
2-3	Simmering	Simmering rice or milk-based dishes, steaming smaller quantities of potatoes and vegetables, heating ready-to-serve meals.
1-2, L	Melting	Fluffy omelettes, keeping dishes warm, melting butter or chocolate.
0	OFF	Off setting.

NOTE: These settings are recommended guidelines for cooking. You may need to adjust the power level for the type of food and pan.

USING THE BRIDGE COOKING ZONES

BRIDGE COOKING ZONES

The two left Cooking Zones can be used together as a single Cooking Zone using the Bridge function. This allows you to cook with larger, oblong pans.

NOTE: When using the supplied bridge pan, it is important to rub it with oil to prevent burning and sticking.

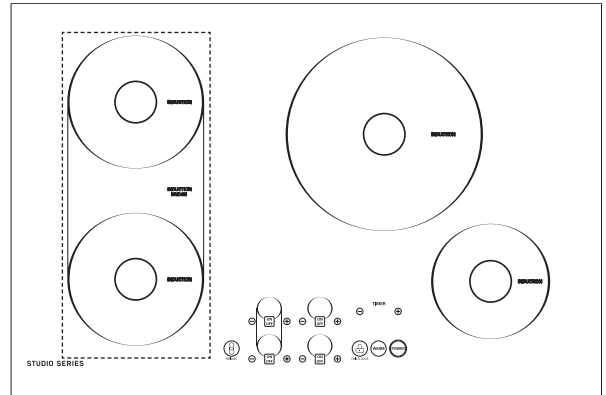

ACTIVATING THE BRIDGE COOKING ZONE



Touch the BRIDGE pad. The indicator above the pad will light.

Touch the **+** or **-** pad for either left Cooking Zone to adjust the power level for both Cooking Zones.

NOTE:

- Use the supplied bridge pan **ONLY** on the bridge cooking zone.
- To purchase a replacement or additional bridge pan, call 1-800-243-0000 (U.S.A) or 1-800-542-2623 (Canada) and choose the appropriate prompt from the menu. Or, visit our Web site at us.lgservice.com (U.S.A) or ca.lgservice.com (Canada).

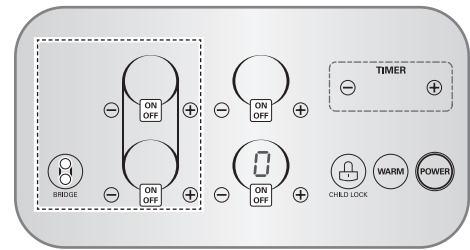

USING THE TIMER

The timer feature may be helpful if a recipe calls for cooking for a set time. The timer can be set from 1 to 99 minutes. Once set, the digital display between the timer **+** or **-** pads will begin to count down the remaining time in minutes.

NOTE: The timer function is a minute timer only. It does **NOT** turn the cooktop ON or OFF.

SETTING THE TIMER

- 1 Touch the **+** or **-** pads under the word **TIMER**. Each touch will increase or decrease the time by one minute, from 1 to 99 minutes. You may also touch and hold **+** or **-** to scroll up or down. The timer display will flash.
- 2 Once the desired time is set, the display will stop flashing and the timer will start counting down after no pad has been touched for 5 seconds. Once the timer reaches **00**, a long beep will sound to indicate the time is up.

CANCELING THE TIMER

- 1 To cancel the timer, touch the **TIMER** **+** and **-** pads at the same time, **OR** Touch and hold the **+** or **-** pad until **00** appears in the display.
- 2 The timer display will turn off.

OPERATING INSTRUCTIONS

USING CHILD LOCK

You can lock the entire cooktop at any time when it is not in use. Locking the cooktop will prevent Cooking Zones from being turned on accidentally.

SETTING CHILD LOCK



The cooktop must be OFF to set the CHILD LOCK function. If it is not OFF, touch and hold the POWER pad for approximately 2 seconds. The indicator above the POWER pad will turn OFF.



Touch and hold the CHILD LOCK pad for 3 seconds. The indicator light above the CHILD LOCK pad will turn on to indicate that the cooktop is locked.

CANCELING CHILD LOCK



To turn off CHILD LOCK, touch and hold the CHILD LOCK pad for 3 seconds. The indicator light above the pad will go off and the cooktop can now be used normally.

OTHER FUNCTIONS

POWER SHARING

Your cooktop is equipped with four induction Cooking Zones within two heating sections. The right and left Cooking Zones are powered by two independent induction inverters—one inverter for each of the two heating sections. Two Cooking Zones in a heating section share the power of one inverter. This is called power sharing. For example, if you are cooking on both right Cooking Zones, the last power level set will be maintained, while the first Cooking Zone may experience a slight reduction in the power level.

POWER SHARING TIPS:

Remember to set the power level for the food item you wish to keep constant last. When using two Cooking Zones, you can maintain a constant power

level for two pans on separate heating sections. Place one pan on one of the Cooking Zones of the left heating section and the other pan on one of the Cooking Zones of the right heating section.

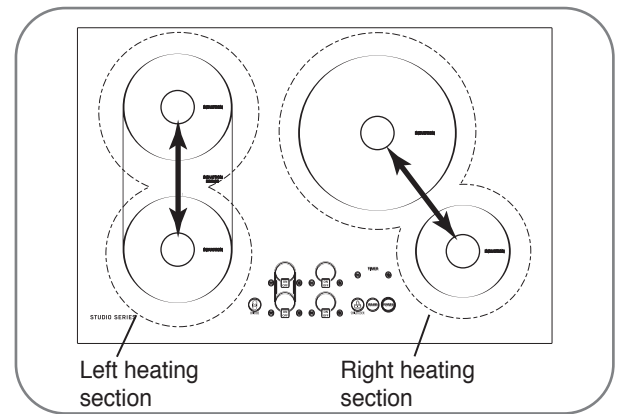

AUTOMATIC SHUTOFF

If a Cooking Zone is in constant use for more than 17 hours and the control setting is not changed, the Cooking Zone will shut off automatically.

AUTOMATIC POWER LEVEL CONTROL

The power level displayed may be different from the actual power level at the high temperature range. To prevent the cooktop from overheating, the power level is controlled automatically.

BEFORE YOU BEGIN

General cleaning for induction ceramic glass cooking surfaces is considerably easier than for cooking surfaces with radiant heating.

NOTE:

To prevent accidental activation of the controls, it is recommended that you set the CHILD LOCK feature before cleaning.

IMPORTANT:

- Cleaning agents must not come in contact with the hot ceramic-glass surface. All cleaning agents must be rinsed off thoroughly with clean water.
- Do not use any aggressive cleaners such as grill or oven sprays, coarse scouring cleansers, or abrasive pan cleaners.
- Clean the ceramic-glass surface after each use when it is warm to the touch or cold. This will prevent spills from becoming burnt on. Remove water marks, grease and discoloration with a glass scraper and ceramic-glass cleaner.

NOTE:

You can obtain glass scrapers and ceramicglass cleaners from your local hardware store.

GENERAL CLEANING

- 1 When it is cool, wipe the ceramic-glass surface with a damp cloth and a small amount of ceramic glass cleaner.
- 2 Wipe dry with a clean cloth.
- 3 Once a week, thoroughly clean the entire ceramic-glass cooking surface with a commercially available ceramic-glass cleaner.
- 4 Then, wipe the ceramic-glass surface using a clean, soft cloth dampened with clean water, and polish dry with a clean lint-free cloth.

REMOVING HEAVY SOIL

To remove food that has boiled over or stubborn spills, use a glass scraper.

- 1 Hold the glass scraper at an angle of about 45° to the ceramic-glass surface.
- 2 Remove soiling by sliding the blade across the area.
- 3 Use a ceramic glass cleaner as described in GENERAL CLEANING.

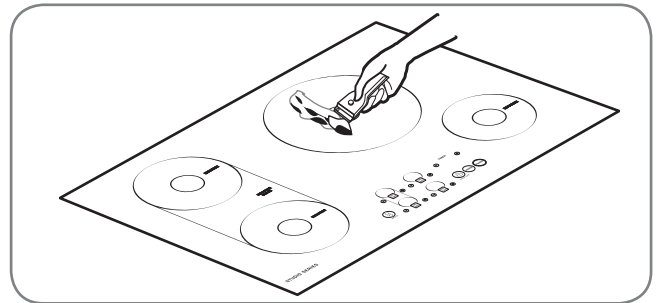

PROBLEM SOILS

- 1 Remove sugar, melted plastic, aluminum foil, or other meltable materials with a glass scraper immediately and while still hot. Failure to do so can cause permanent damage to the cooktop surface. If the Cooking Zone has already cooled down, warm it up again.

IMPORTANT: There is a risk of burning yourself when the glass scraper is used on a hot Cooking Zone. Use care and wear an oven mitt.

- 2 Then clean the cooktop normally when it has cooled down.

NOTE: Scratches or dark marks on the ceramicglass surface caused by a pan base with sharp edges cannot be removed. However, they do not impair the function of the cooktop.

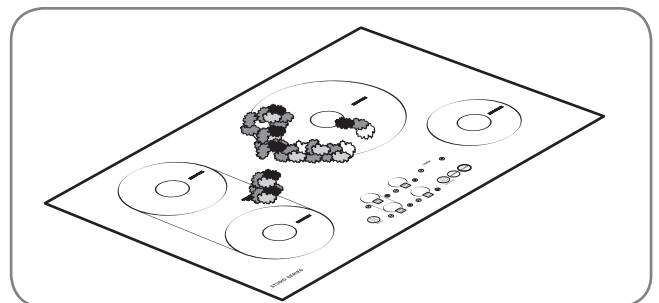

INSTALLATION INSTRUCTIONS

INSTALLATION AND SERVICE MUST BE PERFORMED BY A QUALIFIED INSTALLER. IMPORTANT: SAVE THESE INSTRUCTIONS FOR LOCAL ELECTRICAL INSPECTOR'S USE. READ AND SAVE THESE INSTRUCTIONS FOR FUTURE REFERENCE.

BEFORE YOU BEGIN

Read these instructions completely and carefully.

NOTES TO INSTALLER:

- Read all instructions contained in these installation instructions before installing the cooktop.
- Remove all packing material before connecting the electrical supply to the cooktop.
- Observe all governing codes and ordinances.
- Only certain cooktop models may be installed over certain built-in electric oven models.
- Be sure to leave these instructions with the consumer.

NOTE TO CONSUMER:

Keep this User's Guide and Installation Instructions for future reference.

NOTE: This appliance must be properly grounded. Damage caused by failure to follow these instructions is not covered by the cooktop warranty.

UNPACKING THE COOKTOP

- 1 Unpack and visually inspect the cooktop for any damage or missing components.
- 2 Be sure the bottle of cleaner and conditioner packed in the literature bag is left where the user can find it easily. It is important that the ceramic-glass cooktop be pretreated before use. See CARE AND CLEANING.

TECHNICAL SPECIFICATIONS

COOKTOP DIMENSIONS

Width	30 ⁷ / ₈ " (783 mm)
Depth	21 ³ / ₄ " (552 mm)
Height	2 ³ / ₁₆ " (56 mm)

COOKING ZONES

Position	Diameter	Power
Front Left	7" (180 mm)	1800W (2400W Boost)
Rear Left	7" (180 mm)	1800W (2400W Boost)
Front Right	6" (150 mm)	1400W (1800W Boost)
Rear Right	10 ¹ / ₄ " (260 mm)	2400W (3300W Boost)

COUNTERTOP CUTOUT DIMENSIONS

Width	29 ³ / ₈ " (746 mm)
Depth	20 ¹ / ₄ " (515 mm)

ELECTRICAL SPECIFICATIONS

Connection voltage:
240/208 VAC 60 Hz.

Maximum connected power load:
7.4 kW/6.8 kW

* The rated power consumption may vary according to pan size and type.

INSTALLATION INSTRUCTIONS

PREPARING THE INSTALLATION LOCATION

IMPORTANT INSTALLATION INFORMATION

- All electric cooktops run off a single phase, three-wire or four-wire cable, 240/208 volt, 60 hertz, AC-only electrical supply with ground.
- Minimum distance between cooktop and overhead cabinetry is 30" (76.2 cm).

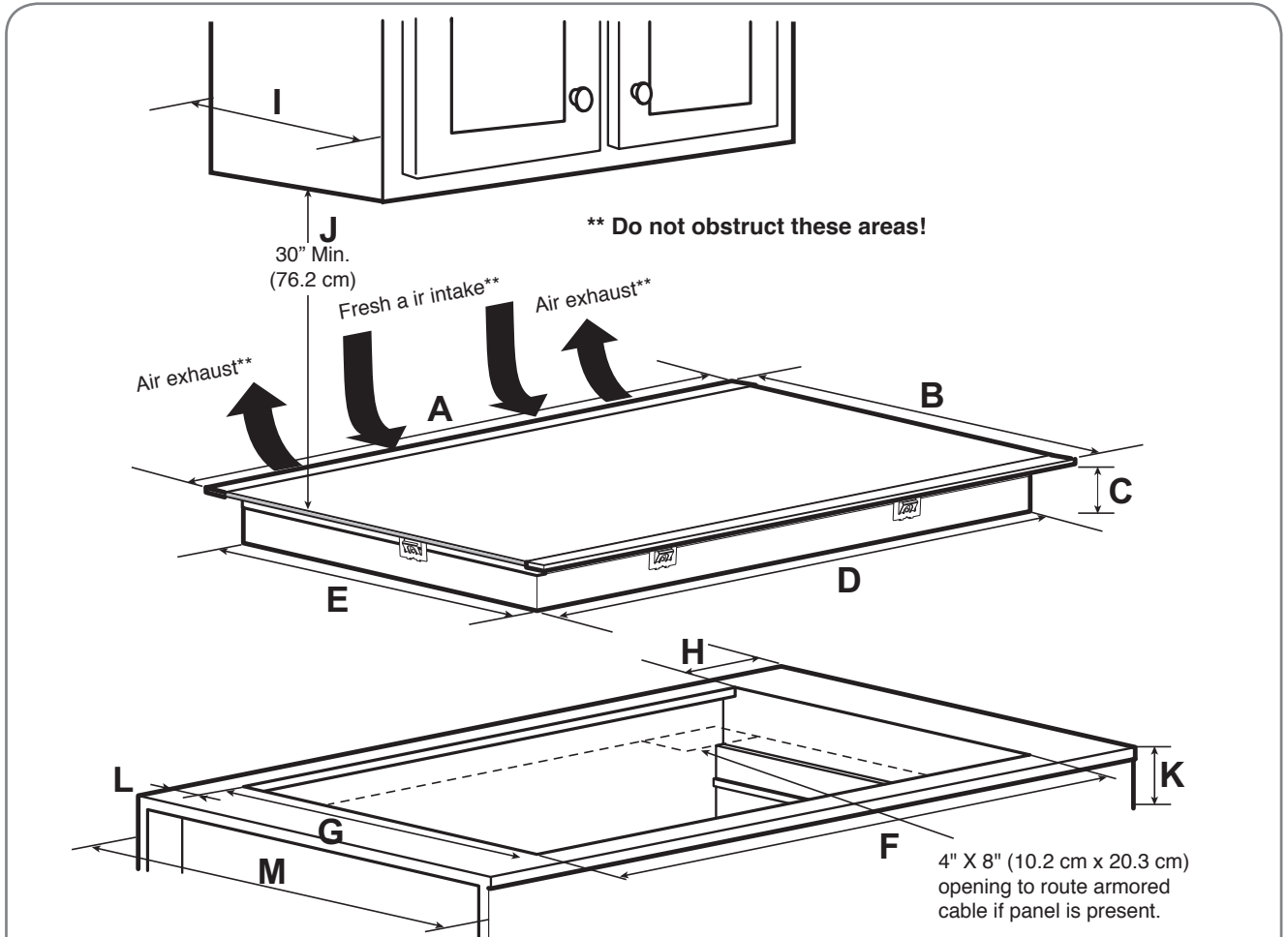

Unit	A	B	C	D	E	F		G		H	I	J		K	L	M
						Min	Max	Min	Max			Min	Max			
Inch	30 ¹³ / ₁₆	21 ³ / ₄	2 ³ / ₁₆	28 ¹³ / ₁₆	19 ⁵ / ₈	29 ³ / ₈	29 ¹ / ₂	20 ¹ / ₄	20 ³ / ₈	1 ³ / ₁₆	1 ⁵ / ₁₆	24	30	4 ³ / ₁₆	1 ¹ / ₂	24
mm	783	552	56	732.2	498	746	749	515	518	20	33	610	762	106	38	610

All dimensions are stated in inches and millimeters (mm).

Allow 2" (5 cm) space below the armored cable opening to clear the electric cable and allow space for installation of the junction box on the wall at the back of the cooktop.

INSTALLATION INSTRUCTIONS

DIMENSIONS AND CLEARANCES

Overhead cabinet should not exceed a maximum depth of 13" (33 cm).

30" (76.2 cm) min. clearance between the top of the cooktop and the bottom of an unprotected wood or metal cabinet.

24" (61 cm) min. when bottom of wood or metal cabinet is protected by not less than 1/8" flame-retardant millboard covered with no less than No. 28 MGS sheet steel, 0.015" (0.4 mm) stainless steel, 0.024" (0.6 mm) aluminum, or 0.020" (0.5 mm) copper.

Min. recommended distance between rear edge of cutout and nearest combustible surface.

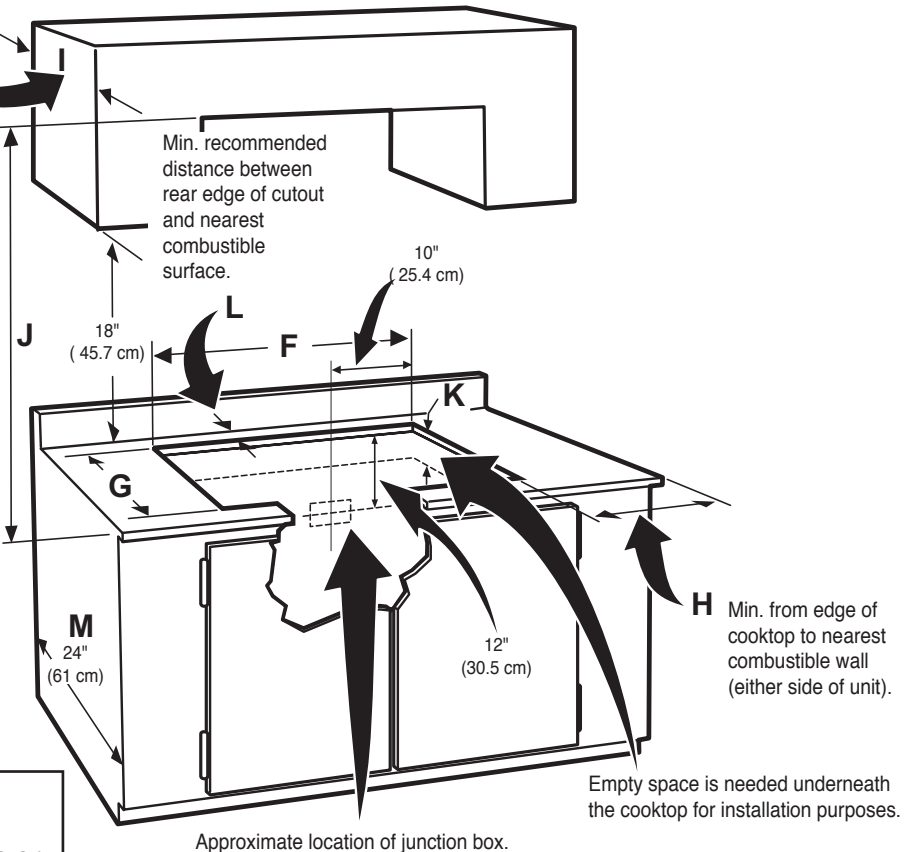

Empty space is needed underneath the cooktop for installation purposes.

CAUTION

To eliminate the risk of burns or fire by reaching over heated surfaces, cabinet storage space located above the cooktop should be avoided. If cabinet storage is provided, risk can be reduced by installing a range hood that projects horizontally a minimum of 5" (12.7 cm) beyond the face of the cabinets.

Model	H	K
30"	7 ¹ / ₂ " (191mm)	1 ¹ / ₂ " (38mm)

CAUTION

It is very important to keep 2³/₄" (70 mm) distance between the cooktop and the oven.

Recommend space cooktop and oven

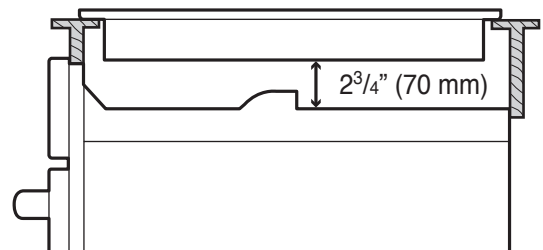

ELECTRICAL CONNECTIONS

IMPORTANT SAFETY INSTRUCTIONS

- Be sure your cooktop is installed and grounded properly by a qualified installer or service technician.
- This cooktop must be electrically grounded in accordance with local codes or, in their absence, with the National Electrical Code ANSI/NFPA No. 70, latest edition in the United States.

WARNING

The electrical power to the cooktop must be shut off while line connections are being made. Failure to do so could result in serious injury or death.

PROVIDING THE ELECTRICAL CONNECTION

Install the junction box under the cabinet and run 120/240 or 120/208 volt, AC wire from the main circuit panel.

NOTE: DO NOT connect the wire to the circuit panel at this time.

ELECTRICAL REQUIREMENTS

Observe all governing codes and local ordinances.

- 1 A 3-wire or 4-wire single-phase 120/240 or 120/208 volt, 60 Hz AC-only electrical supply is required on a separate circuit fused on both sides of the line (time-delay fuse or circuit breaker is recommended). DO NOT fuse neutral. The fuse size must not exceed the circuit rating of the appliance specified on the nameplate.
- 2 This unit can consume up to 7,400W at 240 VAC. A 40 Amp circuit breaker with wire gauge #8 AWG must be used.

NOTE: Wire sizes and connections must conform with the fuse size and rating of the appliance in accordance with the National Electrical Code ANSI/NFPA No. 70, latest edition, and local codes and ordinances.

WARNING

An extension cord must not be used with this appliance. Such use may result in a fire, electrical shock, or other personal injury.

- 3 The appliance should be connected to the fused disconnect (or circuit breaker) box through flexible armored or nonmetallic sheathed cable. The flexible armored cable extending from this appliance should be connected directly to the grounded junction box. The junction box should be located as shown on page 22 with as much slack as possible remaining in the cable between the box and the appliance, so it can be moved if servicing is ever necessary.
- 4 A suitable strain relief must be provided to attach the flexible armored cable to the junction box.

INSTALLATION INSTRUCTIONS

ELECTRICAL CONNECTIONS (cont.)

ELECTRICAL CONNECTION

Connect the flexible armored cable that extends from the surface unit to the junction box using a suitable strain relief at the point the armored cable enters the junction box. Then make the electrical connection as follows.

Electrical ground is required on this appliance. This appliance is manufactured with a supply wire and a frame connected green or bare copper grounding wire.

NOTE TO ELECTRICIAN:

The armored cable leads supplied with the appliance are UL-listed for connection to larger gauge household wiring. The insulation of the leads is rated at temperatures much higher than the temperature rating of household wiring. The current-carrying capacity of the conductor wire is governed by the temperature rating of the insulation around the wire, rather than the wire gauge alone.

⚠ WARNING

DO NOT ground to a gas supply pipe. DO NOT connect to electrical power supply until appliance is permanently grounded. Connect the ground wire before turning on the power.

⚠ WARNING

This appliance is equipped with a copper conductor flexible cable. If connection is made to aluminum house wiring, use only special connectors which are approved for joining copper and aluminum wires in accordance with the National Electrical Code and local codes and ordinances. Improper connection of aluminum house wiring to copper leads can result in a short circuit or fire. Follow the connector manufacturer's recommended procedure closely.

WHERE LOCAL CODES PERMIT CONNECTING THE APPLIANCE-GROUNDING CONDUCTOR TO THE NEUTRAL (WHITE) WIRE

Observe all governing codes and local ordinances.

- 1 Disconnect the power supply.
- 2 At the circuit breaker box, fuse box or junction box, connect appliance and power supply cable wires as shown.

⚠ WARNING

You may not ground the cooktop through the neutral (white) wire if cooktop is used in a new branch circuit installation (1996 NEC), mobile home, recreational vehicle, or where local codes do not permit grounding to the neutral (white) wire. When grounding to the neutral (white) wire is prohibited, you must use a 4-wire power supply cable. Failure to heed this warning may result in electrocution or other serious personal injury.

3-WIRE GROUNDED JUNCTION BOX

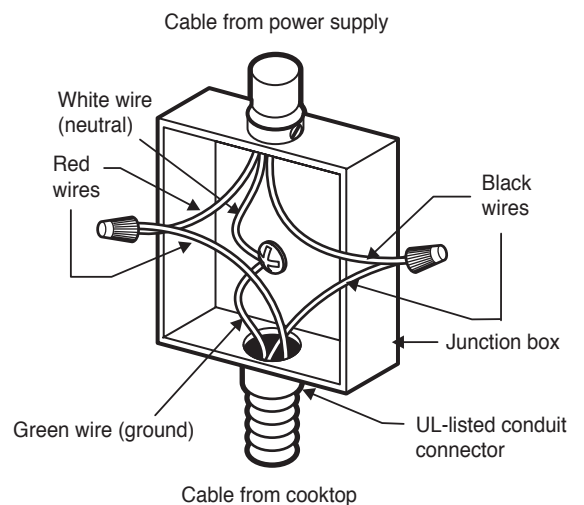

INSTALLATION INSTRUCTIONS

ELECTRICAL CONNECTIONS (cont.)

IF COOKTOP IS USED IN A NEW BRANCH CIRCUIT INSTALLATION (1996 NEC), MOBILE HOME, RECREATIONAL VEHICLE, OR WHERE LOCAL CODES DO NOT PERMIT GROUNDING TO THE NEUTRAL (WHITE) WIRE

Observe all governing codes and local ordinances.

- 1 Disconnect the power supply.
- 2 At the circuit breaker box, fuse box or junction box, connect appliance and power supply cable wires as shown.

⚠ WARNING

If connecting to a 4-wire power supply cable electrical system, the appliance frame connected ground wire **MUST NOT** be connected to the neutral wire of the 4-wire electrical system.

4-WIRE GROUNDED JUNCTION BOX

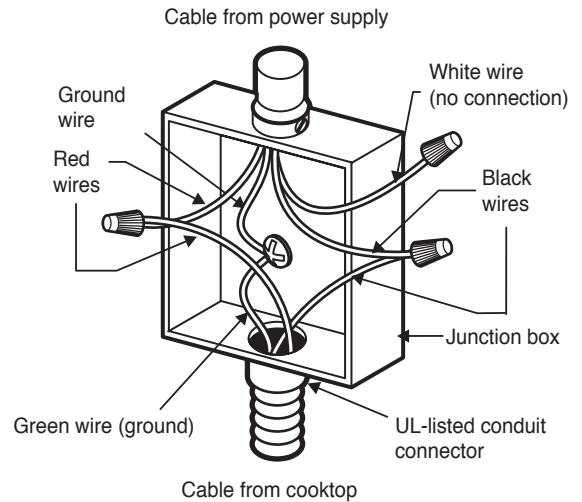

COOKTOP INSTALLATION

- 1 Visually inspect the cooktop for damage. Make sure all cooktop screws are tight (see below for locations).

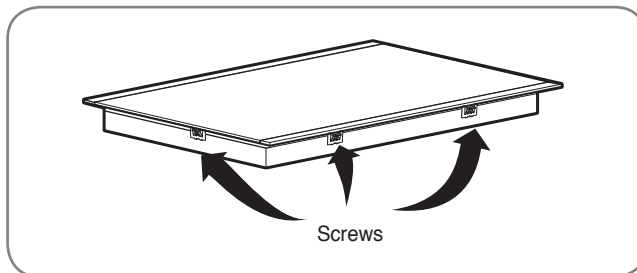

⚠ WARNING

Do not remove the nylon spacers on the edges of the cooktop. These spacers center the cooktop in the space provided. The cooktop must be centered to allow proper venting and to prevent excess heat buildup that may result in heat damage or fire.

- 2 Carefully lower the cooktop into the countertop cutout, making sure not to trap any wires. **NOTE:** Do not use caulking compound. The cooktop must be removable, should service be required.

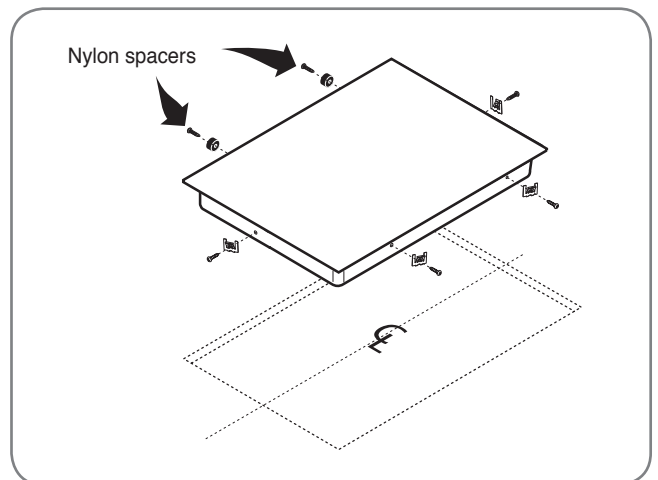

INSTALLATION INSTRUCTIONS

COOKTOP INSTALLATION (cont.)

- 3 Install the retainer brackets to the bottom of the cooktop; then snug the bolts against the bottom of the countertop as shown.

NOTE: The retainer brackets **MUST** be installed to meet local codes or, in their absence, with the National Electrical Code ANSI/NFPA No. 70, latest edition.

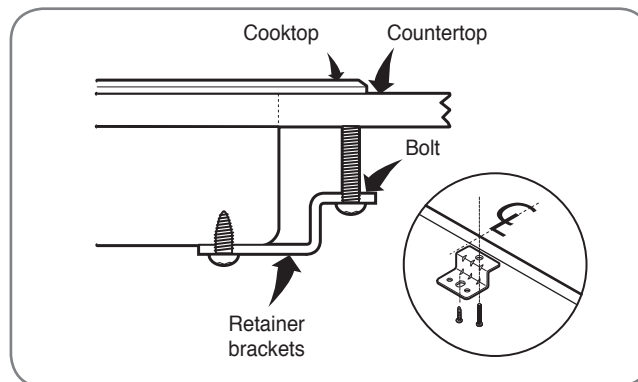
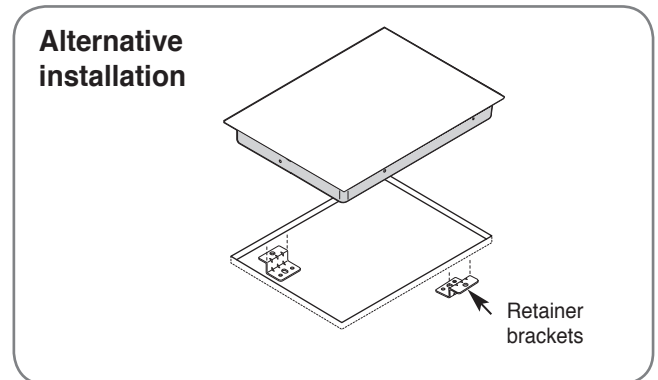
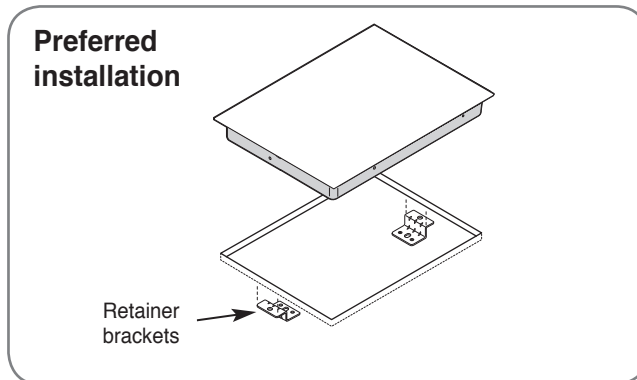

FINAL CHECK

Perform a final operational check of the cooktop, making sure the cooktop powers on properly and that each Cooking Zone operates correctly. Refer to the Operating Instructions in this guide for details.

⚠ CAUTION

Do not touch cooktop glass or Cooking Zones. They may be hot enough to cause burns.

MODEL AND SERIAL NUMBER LOCATION

The model and serial numbers are located on a plate on the bottom of the cooktop. Please record them in this guide; you will need them for warranty registration.

BEFORE CALLING FOR SERVICE

Before you call for service, review this list. It may save you time and expense. This list includes common occurrences that are not the result of a defect in workmanship or materials.

Problem	Possible Causes	Solutions
Cooktop does not work	<ul style="list-style-type: none"> • Cooktop controls are locked. • Circuit breaker has tripped or fuse is blown. • Power outage. • Installation wiring not complete. 	<ul style="list-style-type: none"> • See USING CHILD LOCK to turn off the CHILD LOCK feature. • Reset the circuit breaker. • Check house lights to confirm power outage. • Contact the installer or dealer.
Cooktop does not heat	<ul style="list-style-type: none"> • No cookware or improper cookware on Cooking Zone. • Cookware incorrect size for selected Cooking Zone. • Cookware not resting completely on Cooking Zone. • Incorrect Cooking Zone selected. • No power to cooktop. 	<ul style="list-style-type: none"> • Make sure that cookware is centered on the cooking zone, and that cookware is of the proper type for induction cooking. See SELECTING COOKWARE. • Cookware bottom must be large enough to cover Cooking Zone completely. See SELECTING COOKWARE. • Cookware bottoms must be flat and centered on the Cooking Zone, and must not rest on the cooktop trim. See SELECTING COOKWARE. • Make sure the correct control is ON for the Cooking Zone being used. • See “Cooktop does not work” above.
Cooktop turns off while cooking.	<ul style="list-style-type: none"> • Cooktop internal heat sensor has detected high temperature inside the cooktop. • Automatic shutoff has activated. • Liquid or object on controls area. 	<ul style="list-style-type: none"> • Make sure the cooktop vents are not blocked. See page 21 for Air Exhaust and Fresh Air Intake locations. • The cooktop features an automatic shutoff feature that turns the entire cooktop off if any Cooking Zone has been on continuously for 17 hours. • The cooktop control may read liquids or objects in the controls area as a touch, which could cause the cooktop to shut off. Clean up spills or remove objects and restart cooktop.
The power level for a Cooking Zone is flashing	<ul style="list-style-type: none"> • Cookware has been removed from the Cooking Zone. • Cookware not centered on Cooking Zone. 	<ul style="list-style-type: none"> • Place the cookware back on the Cooking Zone within 90 seconds to maintain the power level settings. • Make sure cookware is centered and resting flat on the Cooking Zone. See SELECTING COOKWARE.
Power Boost does not work	<ul style="list-style-type: none"> • Power Boost being used with two Cooking Zones on the same side of the cooktop. 	<ul style="list-style-type: none"> • Each side of the cooktop shares an inverter for both Cooking Zone. Power Boost cannot be used with two Cooking Zones on the same inverter at the same time See POWER BOOST and POWER SHARING.

TROUBLESHOOTING

BEFORE CALLING FOR SERVICE

Problem	Possible Causes	Solutions
E1 appears in the timer display	<ul style="list-style-type: none"> Control pad was touched too long. 	<ul style="list-style-type: none"> This message will appear if any pad except the Timer + or - pads is touched for more than 10 seconds. It will also appear if liquids or objects are spilled or left on the controls area. To clear the error code, remove any liquid or objects from the controls area and press the POWER pad to reset the cooktop.
E2 appears in the timer display	<ul style="list-style-type: none"> Supplied voltage to cooktop is too low. 	<ul style="list-style-type: none"> If the voltage of the power supplied to the cooktop is too low, it cannot operate properly and will show this error code. This may be caused by reduced voltage being supplied to the house circuit. If connections are correct and the supplied voltage returns to normal, the code will disappear.
F appears in the display and a number appears in the timer display	<ul style="list-style-type: none"> Electronics fault error message. 	<ul style="list-style-type: none"> Turn the cooktop OFF; then shut off power at the fuse or circuit breaker for about 30 seconds. Turn power back on to the cooktop and turn the cooktop on using the POWER pad. If the error message is still displayed, call for service.
H flashes in the display	<ul style="list-style-type: none"> Power outage or initial startup. 	<ul style="list-style-type: none"> When the cooktop is first turned on or after a power outage, H will blink in the display for 90 minutes or until the POWER pad is touched for 2 seconds.

LG ELECTRONICS, INC. LG INDUCTION COOKTOP LIMITED WARRANTY - USA



LG Electronics Inc. will repair or replace your product, at LG's option, if it proves to be defective in material or workmanship under normal use, during the warranty period set forth below, effective from the date of original consumer purchase of the product. This limited warranty is good only to the original purchaser of the product and effective only when used in U.S.A.

WARRANTY PERIOD:	WHAT IS COVERED:
Two years from date of original purchase	Any part of the cooktop which fails due to a defect in materials or workmanship. During this full two-years warranty , LG will also provide, free of charge , all labor and in-home service to replace the defective part.
Please retain dealer's dated bill of sale as evidence of the Date of Purchase for proof of warranty, and submit a copy of the bill of sale to the service person at the time warranty service is provided. Please call 1-800-243-0000 and choose the appropriate option to locate your nearest LG Authorized Service Center. Or visit our Web site at http://us.lgservice.com .	

THIS WARRANTY IS IN LIEU OF ANY OTHER WARRANTIES, EXPRESS OR IMPLIED, INCLUDING WITHOUT LIMITATION, ANY WARRANTY OF MERCHANTABILITY OR FITNESS FOR A PARTICULAR PURPOSE. TO THE EXTENT ANY IMPLIED WARRANTY IS REQUIRED BY LAW, IT IS LIMITED IN DURATION TO THE EXPRESS WARRANTY PERIOD ABOVE. LG WILL NOT BE LIABLE FOR ANY CONSEQUENTIAL, INDIRECT, OR INCIDENTAL DAMAGES OF ANY KIND, INCLUDING LOST REVENUES OR PROFITS, IN CONNECTION WITH THE PRODUCT. SOME STATES DO NOT ALLOW LIMITATION ON HOW LONG AN IMPLIED WARRANTY LASTS OR THE EXCLUSION OF INCIDENTAL OR CONSEQUENTIAL DAMAGES, SO THE ABOVE LIMITATIONS OR EXCLUSIONS MAY NOT APPLY TO YOU.

THIS LIMITED WARRANTY DOES NOT APPLY TO:

1. Service calls to correct the installation of your appliance, to instruct you how to use your appliance, to replace house fuses or correct house wiring, or to replace owner-accessible light bulbs.
2. Repairs when your appliance is used in other than normal, single-family household use.
3. Pickup and delivery. Your appliance is designed to be repairable in the home.
4. Damage resulting from accident, alteration, misuse, abuse, fire, flood, improper installation, acts of God, or use of products not approved by LG Corporation.
5. Repairs to parts or systems resulting from unauthorized modifications made to the appliance.
6. Replacement parts or repair labor costs for units operated outside the United States.
7. Any labor costs during the limited warranty period.

This warranty is extended to the original purchaser for products purchased for home use within the USA. In Alaska, the warranty excludes the cost of shipping or service calls to your home. Some states do not allow the exclusion or limitation of incidental or consequential damages, so this exclusion or limitation may not apply to you. This warranty gives you specific legal rights, and you may also have other rights which vary from state to state. To know what your legal rights are, consult your local or state consumer affairs or your state's Attorney General.

TO CONTACT LG ELECTRONICS BY MAIL:

LG Customer Interactive Center
P. O. Box 240007
201 James Record Road
Huntsville, Alabama 35824
ATTN: CIC

MEMO



LG Customer Information Center

1-800-243-0000 USA, Consumer User
1-888-865-3026 USA, Commercial User

Register your product Online!

www.lg.com