



Contact SAMSUNG WORLDWIDE

If you have any questions or comments about your Samsung TV, please contact the SAMSUNG customer care center.

Comment contacter Samsung dans le monde

Si vous avez des suggestions ou des questions concernant les produits Samsung, veuillez contacter le Service Consommateurs Samsung.

Comuníquese con SAMSUNG WORLD WIDE

Si desea formular alguna pregunta o comentario en relación con los productos de Samsung, comuníquese con el centro de atención al cliente de SAMSUNG.

Country	CANADA	U.S.A
Address	Samsung Electronics Canada Inc., Customer Service 55 Standish Court Mississauga Ontario L5R 4B2 Canada	Samsung Electronics America, Inc. 85 Challenger Road Ridgefield Park, NJ 07660-2112
Customer Care Center ☎	1-800-SAMSUNG (726-7864)	
Web Site	www.samsung.com	



SERIES **6**
6030
6070

LED TV

user manual

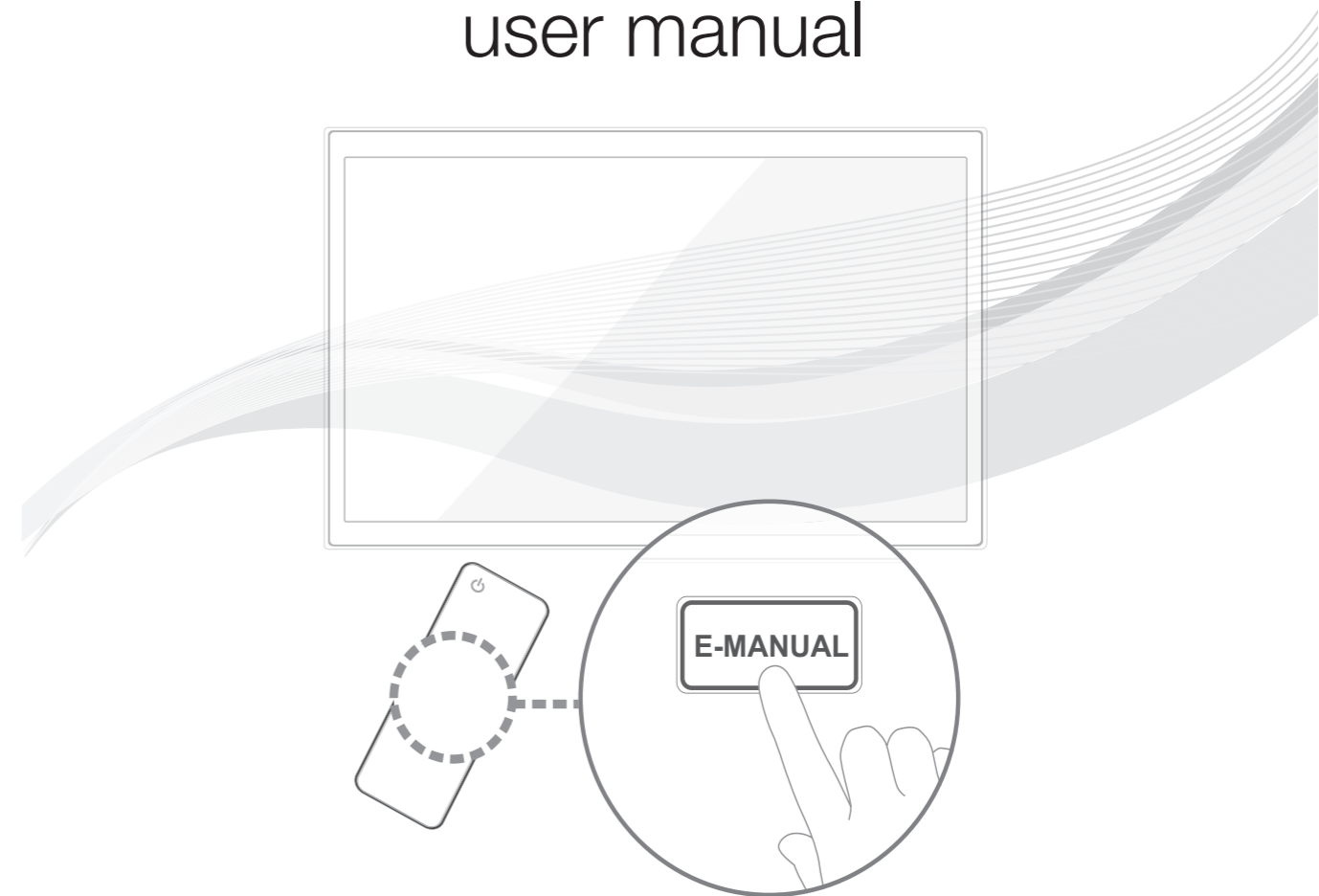

Thank you for purchasing this Samsung product.
To receive more complete service, please register
your product at
www.samsung.com/register

Model _____ Serial No. _____

If you have any questions, please call us at 1-800-SAMSUNG (1-800-726-7864) for assistance.



BN68-04458A-01

A detailed User's Manual is built into your TV. For more information about how to view this e-Manual, see page 16.

Figures and illustrations in this User Manual are provided for reference only and may differ from actual product appearances. Product design and specifications may be changed without notice.

Important Warranty Information Regarding Television Format Viewing

See the warranty card for more information on warranty terms.

Wide screen format LED Displays (16:9, the aspect ratio of the screen width to height) are primarily designed to view wide screen format full-motion video. The images displayed on them should primarily be in the wide screen 16:9 ratio format, or expanded to fill the screen if your model offers this feature and the images are constantly moving. Displaying stationary graphics and images on screen, such as the dark sidebars on non-expanded standard format television video and programming, should be limited to no more than 5% of the total television viewing per week. Additionally, viewing other stationary images and text such as stock market reports, video game displays, station logos, web sites or computer graphics and patterns, should be limited as described above for all televisions. Displaying stationary images that exceed the above guidelines can cause uneven aging of LED Displays that leave subtle, but permanent burned-in ghost images in the LED picture. To avoid this, vary the programming and images, and primarily display full screen moving images, not stationary patterns or dark bars. On LED models that offer picture sizing features, use these controls to view different formats as a full screen picture. Be careful in the selection and duration of television formats you use for viewing. Uneven LED aging as a result of format selection and use, as well as burned-in images, are not covered by your Samsung limited warranty.

- **SAMSUNG ELECTRONICS NORTH AMERICAN LIMITED WARRANTY STATEMENT**

Subject to the requirements, conditions, exclusions and limitations of the original Limited Warranty supplied with Samsung Electronics (SAMSUNG) products, and the requirements, conditions, exclusions and limitations contained herein, SAMSUNG will additionally provide Warranty Repair Service in the United States on SAMSUNG products purchased in Canada, and in Canada on SAMSUNG products purchased in the United States, for the warranty period originally specified, and to the Original Purchaser only.

The above described warranty repairs must be performed by a SAMSUNG Authorized Service Center. Along with this Statement, the Original Limited Warranty Statement and a dated Bill of Sale as Proof of Purchase must be presented to the Service Center. Transportation to and from the Service Center is the responsibility of the purchaser. Conditions covered are limited only to manufacturing defects in material or workmanship, and only those encountered in normal use of the product. Excluded, but not limited to, are any originally specified provisions for, in-home or on-site services, minimum or maximum repair times, exchanges or replacements, accessories, options, upgrades, or consumables.

For the location of a SAMSUNG Authorized Service Center, please call toll-free:

- In the United States : 1-800-SAMSUNG (1-800-726-7864)

- In Canada : 1-800-SAMSUNG

Still image warning

Avoid displaying still images (such as jpeg picture files) or still image elements (such as TV channel logos, panorama or 4:3 image format, stock or news bars at screen bottom etc.) on the screen. Constant displaying of still pictures can cause ghosting of LED screen, which will affect image quality. To reduce risk of this effect, please follow below recommendations:

- Avoid displaying the same TV channel for long periods.
- Always try to display any image on full screen, use TV set picture format menu for best possible match.
- Reduce brightness and contrast values to minimum required to achieve desired picture quality, exceeded values may speed up the burnout process.
- Frequently use all TV features designed to reduce image retention and screen burnout, refer to proper user manual section for details.

Providing Proper Ventilation for Your TV

When you install your TV, maintain a distance of at least 4 inches between the TV and other objects (walls, cabinet sides, etc.) to ensure proper ventilation. Failing to maintain proper ventilation may result in a fire or a problem with the product caused by an increase in its internal temperature.

Whether you install your TV using a stand or a wall-mount, use parts provided by Samsung Electronics only.

- If you use parts provided by another manufacturer, it may cause difficulties with the product or result in injury caused by the product falling.

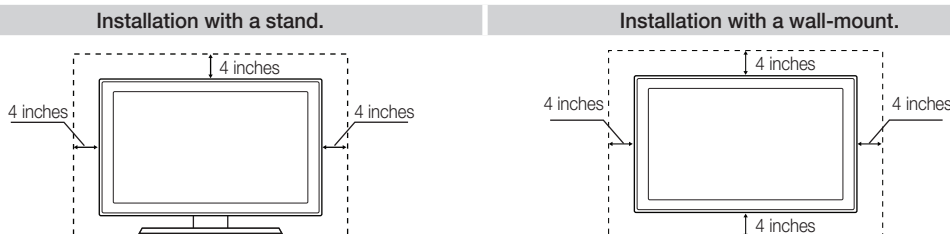

Accessories and Cables

- ✎ Please make sure the following items are included with your TV. If any items are missing, contact your dealer.
- ✎ The items' colors and shapes may vary depending on the model.
- ✎ Check that there are no accessories hidden behind or under packing materials after you open the box.

- Remote Control (AA59-00601A) & Batteries (AAA x 2)
- Owner's Instructions
- Power Cord
- Warranty Card / Safety Guide
- 3D Glasses
- Holder-Wire Stand (BN61-05491A)

Assembling the Holder-Wire stand

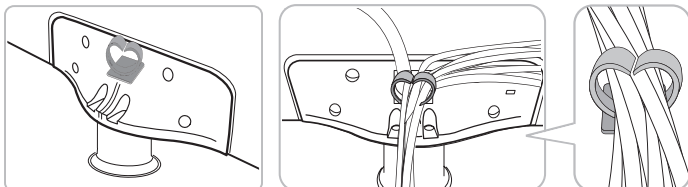

Input Cables (Sold Separately)

To purchase the RS232 cable, contact www.SamsungParts.com.



RS232 (AA39-00311A)



HDMI



HDMI-DVI



Audio



Component



Composite (AV)

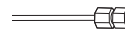

Coaxial (RF)

- ✎ Make sure you have the correct cable before plugging it in. Illustrations of common plugs and jacks are below.

	Cable	Ports
HDMI		
USB		
Optical		

- ✎ For the best cable connection to this product, use cables no thicker than the cable illustrated below:

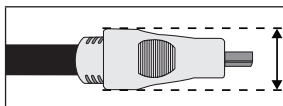

- Maximum thickness - 0.55 inches (14mm)

Connecting the Power Cord and the Antenna or Cable Connection

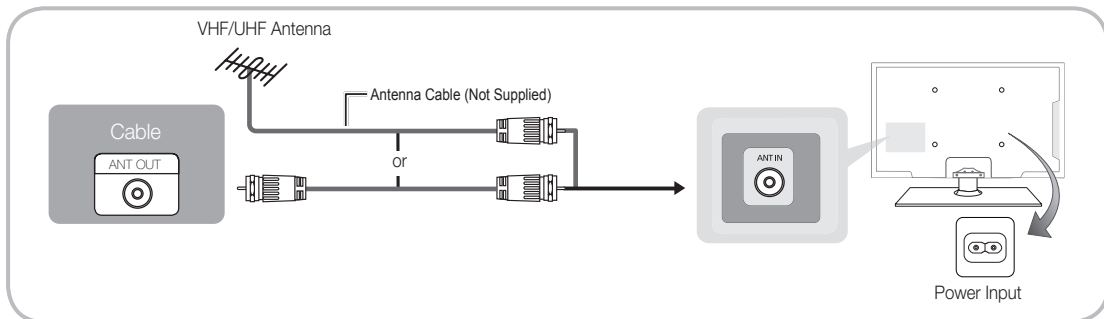

- ✎ Plug the power cord into a wall outlet only after you have made all other connections.
- ✎ If you are connecting your TV to a cable or satellite box using HDMI, Component, or Composite connections, you do not need to connect the ANT IN jack to an antenna or a cable connection.
- ✎ Use caution when you move or swivel the TV if the antenna cable is tightly connected. You could break the antenna jack off the TV.

Connecting to AV Devices (Blu-ray Players, DVD Players, etc.)

Using an HDMI cable or HDMI to DVI Cable for an HD connection (up to 1080p, HD, digital signals)

For the best quality HD picture, we recommend using an HDMI connection.

Use on DVD players, Blu-ray players, HD cable boxes, and HD satellite receivers (STB).

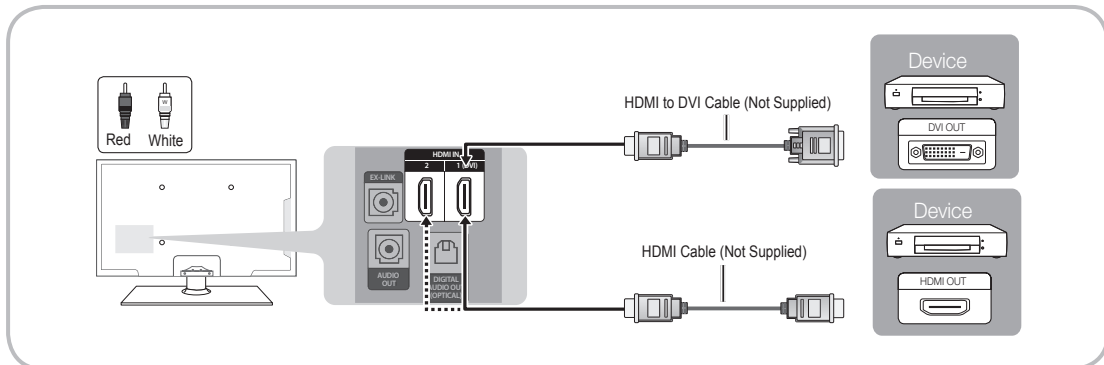

✎ HDMI IN 1 (DVI), 2

- For better picture and audio quality, connect to digital devices using an HDMI cable.
- An HDMI cable supports digital video and audio signals, and does not require an audio cable.
 - To connect the TV to a digital device that does not support HDMI output, use an HDMI to DVI cable and separate audio cables.
- If you connect an external device to the TV that uses an older version of HDMI, the video and audio may not work. If this occurs, ask the manufacturer of the device about the HDMI version and, if it is out of date, request an upgrade.
- Be sure to purchase a certified HDMI cable. Otherwise, the picture may not display or a connection error may occur.
- We recommend using a basic high-speed HDMI cable or an HDMI cable that supports Ethernet. Note that this TV does not support the Ethernet function via HDMI.

✎ If an HDMI to DVI cable is connected to the HDMI IN 1 (DVI) port, the audio does not work.

The EX-LINK Cable Connection



The EX-LINK connection is for service only.

Using a Component Cable (up to 1080p HD signals) or Video Cable (480i, analog signals only)

Use on DVD players, Blu-ray players, cable boxes, STB satellite receivers, and VCRs.

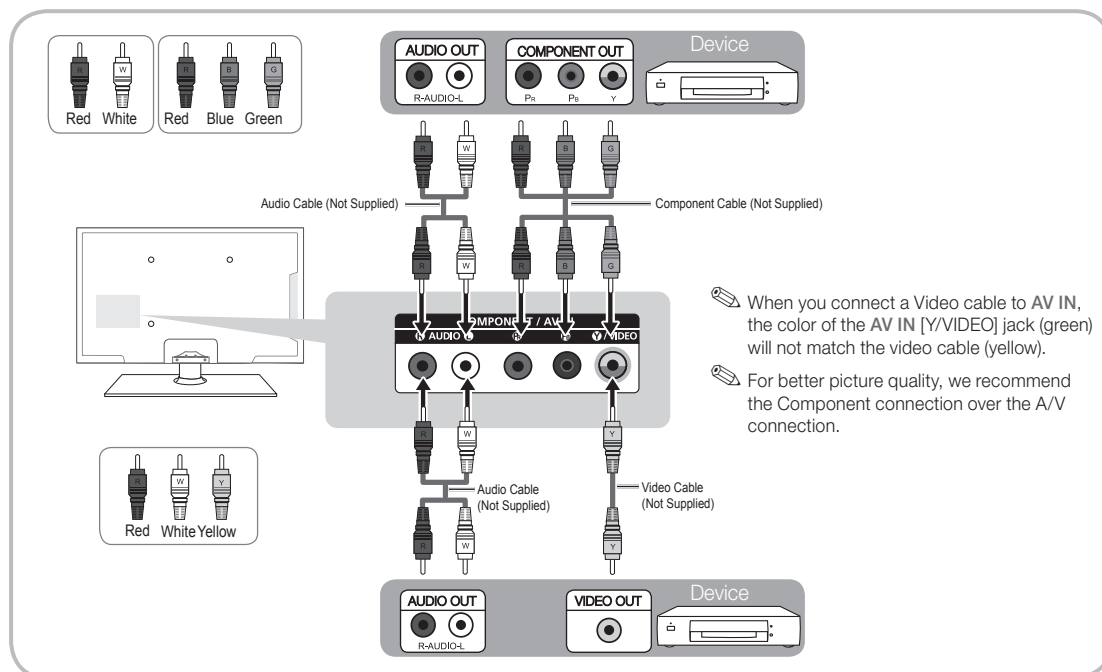

Connecting Audio Devices

Using an Optical (Digital) Cable Connection or a Standard Stereo Connection

Use on Digital Audio Systems, Amplifiers, and Home Theaters.

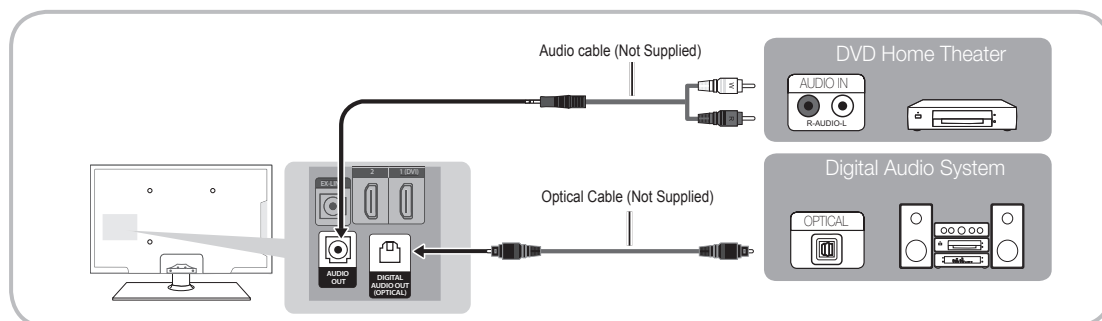

DIGITAL AUDIO OUT (OPTICAL)



- When you connect a Digital Audio System to the **DIGITAL AUDIO OUT (OPTICAL)** jack, decrease the volume of both the TV and the system.
- 5.1 CH (channel) audio is available when you connect the TV to an external device supporting 5.1 CH.
- When the receiver (home theater) is set to on, you can hear sound output from the TV's optical jack. When the TV is receiving a DTV signal, the TV will send 5.1 CH sound to the home theater receiver. When the source is a digital component such as a DVD player / Blu-ray player / cable box / STB (Set-Top-Box) satellite receiver and you connected it to the TV via HDMI, you will only hear 2 CH audio from the home theater receiver. If you want to hear 5.1 CH audio, connect the digital audio out jack from your DVD / Blu-ray player / cable box / STB satellite receiver directly to an amplifier or home theater.

AUDIO OUT: Connects to the audio input jacks on your amplifier/home theater.

- When connecting, use the appropriate connector (sold separately).
- When you connect an audio amplifier to the **AUDIO OUT** jacks, decrease the volume of the TV and adjust the volume level with the amplifier's volume control.

Connecting to a PC

Using an HDMI cable or an HDMI to DVI cable

-  Your PC may not support an HDMI connection.
-  Use your PC speakers for audio.
-  If an HDMI to DVI cable is connected to the **HDMI IN 1(DVI)** port, the audio does not work.

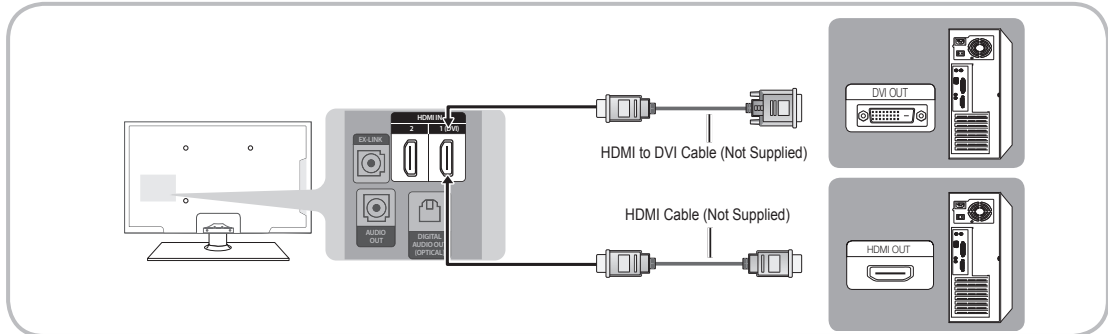

Display Modes (HDMI Input)

Optimal resolution is 1920 X 1080@60Hz.

Mode	Resolution	Horizontal Frequency (KHz)	Vertical Frequency (Hz)	Pixel Clock Frequency (MHz)	Sync Polarity (H / V)
IBM	640 x 350	31.469	70.086	25.175	+/-
	720 x 400	31.469	70.087	28.322	-/+
MAC	640 x 480	35.000	66.667	30.240	-/-
	832 x 624	49.726	74.551	57.284	-/-
	1152 x 870	68.681	75.062	100.000	-/-
VESA DMT	640 x 480	31.469	59.940	25.175	-/-
	640 x 480	37.861	72.809	31.500	-/-
	640 x 480	37.500	75.000	31.500	-/-
	800 x 600	37.879	60.317	40.000	+/+
	800 x 600	48.077	72.188	50.000	+/+
	800 x 600	46.875	75.000	49.500	+/+
	1024 x 768	48.363	60.004	65.000	-/-
	1024 x 768	56.476	70.069	75.000	-/-
	1024 x 768	60.023	75.029	78.750	+/+
	1152 x 864	67.500	75.000	108.000	+/+
	1280 x 720	45.000	60.000	74.250	+/+
	1280 x 800	49.702	59.810	83.500	-/+
	1280 x 1024	63.981	60.020	108.000	+/+
	1280 x 1024	79.976	75.025	135.000	+/+
	1366 x 768	47.712	59.790	85.500	+/+
1440 x 900	55.935	59.887	106.500	-/+	
1600 x 900RB	60.000	60.000	108.000	+/+	
1680 x 1050	65.290	59.954	146.250	-/+	
1920 x 1080	67.500	60.000	148.500	+/+	

Connecting to a Network

You can connect your TV to your local area network (LAN) using a wired or wireless connection.

After you have “physically” connected your TV to your network, you must configure the network connection to complete the process. You can configure the connection during the Initial Setup process (see page 10) or after the Initial Setup process, through the TV’s menu (see page 15).

The Wireless Network Connection

You can connect your TV to your LAN through a standard wireless router or modem. To connect wirelessly, you must first attach a “Samsung Wireless LAN Adapter” (WIS09ABGNX, WIS12ABGNX - sold separately) to the **USB** port on the side of your TV. See the illustration below.

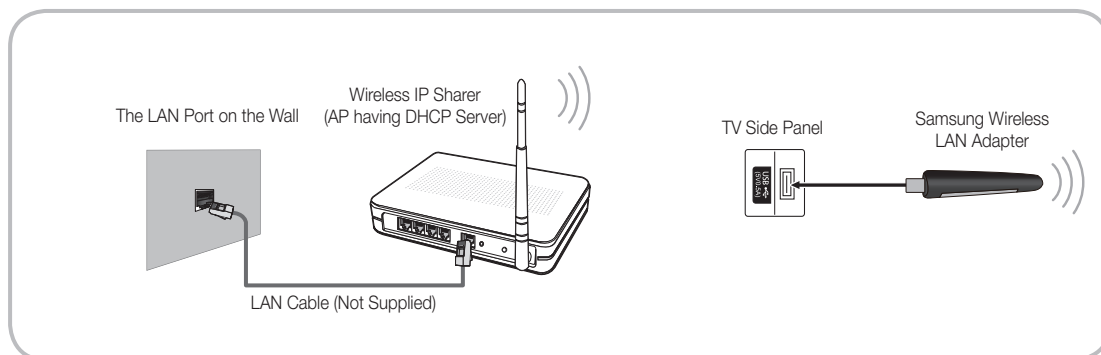

Samsung’s Wireless LAN adapter is sold separately and is offered by select retailers, E-commerce sites, and Samsungparts.com. Samsung’s Wireless LAN adapter supports the IEEE 802.11a/b/g and n communication protocols. Samsung recommends using IEEE 802.11n. When you play video over a network connection using one of the other protocols, the video may not play smoothly.

Wireless Security

Most wireless network systems incorporate a security system that requires devices that access the network through an access point or AP (typically a wireless router or modem) to transmit an encrypted security code called an access key.

Your TV is compatible with the following security protocols:

- Authentication Mode: OPEN, SHARED, WPAPSK, WPA2PSK
- Encryption Type: WEP, TKIP, AES

If you select Pure High-throughput (Greenfield) 802.11n mode and the Encryption type is set to WEP or TKIP on your AP or wireless router, your TV will not support a connection, in compliance with new Wi-Fi certification specifications.

The Wired Network Connection

There are two main ways to connect your TV to your network using cable, depending on your network setup. They are illustrated below:

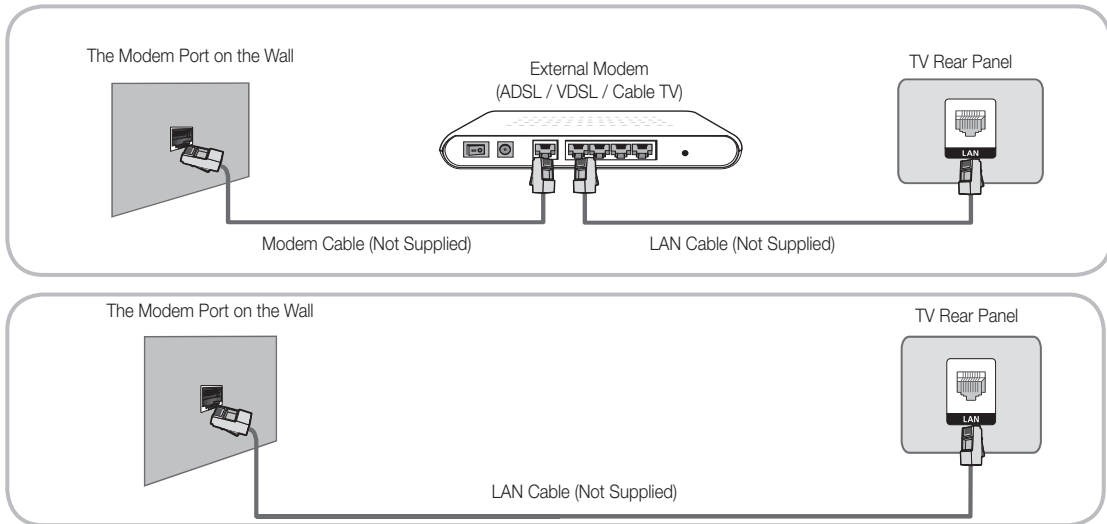

 The TV does not support network speeds less than or equal to 10Mbps.

 Use Cat 6 (STP Type*) cable for the connection. (*Shielded Twisted Pair)

The Remote Control Buttons

This remote control has Braille points on the Power, Channel, and Volume buttons and can be used by visually impaired persons.

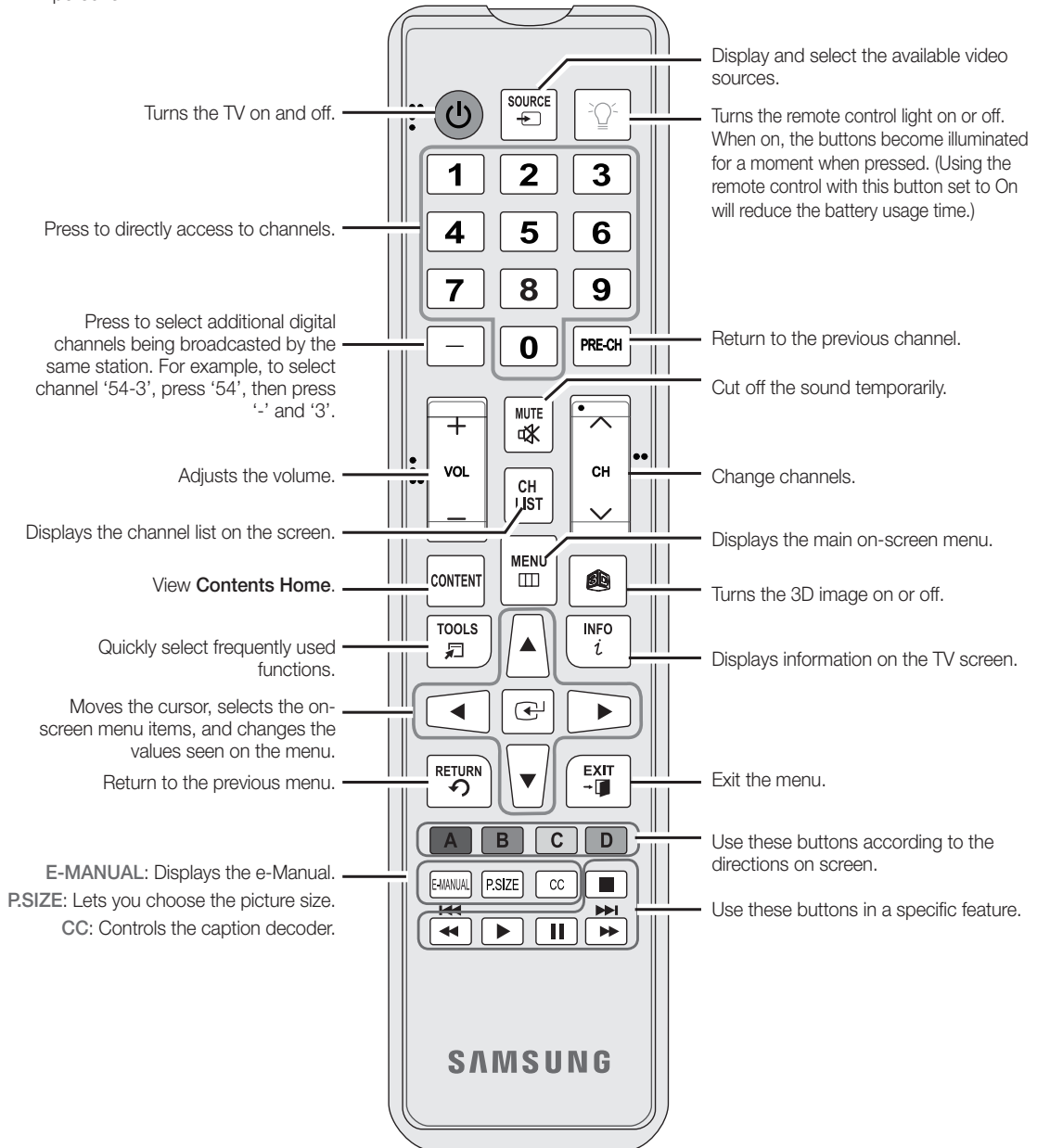

Installing batteries (Battery size: AAA)

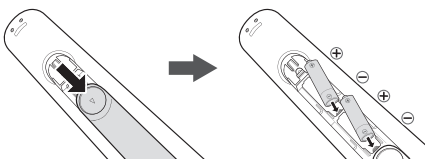































NOTE



























- Install the batteries so that the polarity of the batteries (+/-) matches the illustration in the battery compartment.
- Use the remote control within 23 feet of the TV.
- Bright light may affect the performance of the remote control. Avoid using when near fluorescent lights or neon signs.
- The color and shape may vary depending on the model.

Configuring the Basic Settings in Initial Setup



When you turn the TV on for the first time, a sequence of screens and on-screen prompts will assist you in configuring the TV's basic settings. Plug the power cord into a wall outlet, and then press the **POWER**  button to turn on the TV.

-  **Setup** is available only when the **Source** is set to TV. See Changing the Input Source on page 12.
-  To return to the previous step in the **Setup** sequence, select **Previous**, and then press **ENTER**  button.
-  If you are not using a cable box or satellite box, make you sure have connected the TV to an antenna or cable connection before you turn on the TV. See page 4 for instructions.
-  If you want to configure a network connection, make sure you've connected the Samsung Wireless LAN Adaptor or a LAN cable to your TV. See pages 7 and 8 for instructions.

1	Menu Language: Select a menu language.	<p>After you press the Power Button, the Start Screen appears. Press the ENTER  button on your remote to continue. The Menu Language screen appears.</p> <p>Use the ▲/▼ buttons to select a language, and then press ENTER . The cursor jumps to Next. Press the ENTER  button.</p>	<p>POWER</p> 
2	Use Mode: Select the Use Mode.	<p>On the Use Mode screen, press ENTER  to select the Home Use mode. The cursor jumps to Next. Press the ENTER  button. The Network Settings screen appears.</p> <p> Store Demo mode is for retail environments only. If you select Store Demo, some functions will not work, and the TV will reset all functions to their factory default every 15 minutes. For more information about Store Demo, go to the end of this section.</p>	
3	Network Settings: Configure the network settings.	<ol style="list-style-type: none"> 1. The TV automatically senses whether you connected the Wireless Adaptor or a LAN cable to the TV. To continue configuring the network settings, press the ENTER  button, and then go to Wireless Network or Wired Network below. <ul style="list-style-type: none">  If you do not have a network, select Skip, press the ENTER  button, and then go to Auto Program (1) on the next page.  If you have a Network, you can also select Skip, and then configure your network later through Network Settings in the TV's Menu. For more information, refer to "Setting the Wired Network / Setting the Wireless Network" in the e-Manual or go to page 16 in this manual. 	
3^a	Wireless Network	<ol style="list-style-type: none"> 1. The TV searches for and then displays all the wireless networks within range. When done, it displays a list of the networks. Use the ▲/▼ buttons to select a network, and then press ENTER . The cursor jumps to Next. Press ENTER . The Security Key screen appears. <ul style="list-style-type: none">  If you have a WPS(PBC) compatible router, select WPS(PBC) instead, press ENTER  button, and then follow the directions on the screen. When done, go to Step 4. 2. Enter your network security key or WPS PIN using the remote. <ul style="list-style-type: none">  Enter numbers by pressing the number buttons on your remote.  Enter letters by selecting a letter using the ▲/▼/◀/▶ buttons, and then pressing ENTER .  To display capital letters (or redisplay small letters if capital letters are displayed), select Shift, and then press ENTER .  To display symbols and punctuation, select ★, and then press ENTER . To redisplay letters, select Shift, and then press ENTER . 3. When done, use the ▲/▼/◀/▶ buttons to select Next if you have entered a security key or WPS PIN if you have entered a WPS PIN, and then press ENTER . 4. The TV checks the wireless connection. If the connection is successful, the "Your wireless network and Internet connection are setup and ready to use." message appears. The cursor jumps to Next. Press ENTER , and then go to 4 Software Update on the next page. <ul style="list-style-type: none">  If the connection fails, select Previous, repeat Step 1 and 2, carefully re-enter your security key or WPS PIN, then repeat Steps 3 and 4. If it fails again, select Next on the "Connection Failed" screen, and then go to Auto Program (1) on the next page. Configure your network later through Network Settings in the TV's Menu. For more information, refer to "Setting the Wired Network / Setting the Wireless Network" in the e-Manual. 	

3 ^b	Wired Network	The TV checks the network connection, then displays the “Wired network and Internet connection complete” message appears and highlights Next . Press ENTER  .
4	Software Update: Upgrade the software to the latest version.	<p>On the Software Update screen, press the ENTER  button to upgrade the TV's software. If new software is available, the player downloads and installs the new software. When the download is complete, select Next, and then press ENTER .</p> <p> To upgrade later, select Skip, and then press ENTER . For more information, see “Software Update” in the e-Manual.</p> <p> You can only upgrade software if your TV has an active network connection.</p> <p> If no update software is available, the Auto Program screen appears automatically.</p>
5	Auto Program (1): Select where your TV signal comes from.	<p>Press the ▲ or ▼ button to select the correct option, and then press ENTER  twice.</p> <p>Let's find and store channels on your TV. Do you need to search for channels?</p> <ul style="list-style-type: none"> • Yes, I need to.: Select if you have an antenna or a cable connection without a set-top-box, and then go to Auto Program (2) below. • No, I don't need to.: Select if you have a satellite or cable set-top-box. You do not need to run Auto Program. Select Next or Skip, and then go to 6 Clock - Manual below.
6	Auto Program (2): Select the search options	<ol style="list-style-type: none"> 1. Press ENTER . The Air/Cable screen appears. 2. Press the ▲ or ▼ button to select Air or Cable, and then press ENTER . A check appears next to your selection. Select Next, and then press ENTER . You can check both if you have both connected. 3. If you selected Air, channel memorization starts. Go to 5 Auto Program (3). If you selected Cable, you'll go to the Cable System screen. Use the ▲ or ▼ button to select Digital Cable System, and then press ENTER . Use the ▲ or ▼ button to select the correct cable signal format - STD, HRC, or IRC - and then press ENTER . Most cable systems use STD. Repeat the same process for Analog Cable System. 4. When done, select Next, and then press ENTER .
7	Auto Program (3): Channel memorization	<p>Channel memorization starts. Channel memorization can take up to 45 minutes. When channel memorization is complete, the Channels Memorized screen appears. Press ENTER . The Clock screen appears.</p> <p> You can press ENTER  at any time to halt the memorization process.</p>
8	Clock: Set the Clock	<p>Press the ▲ or ▼ button to select Auto or Manual, and then press ENTER  twice.</p> <p>Auto</p> <p>If you selected Auto, you'll go to the Time Zone screen, and then the DST screen. On the Time Zone screen, use the ▲ or ▼ button to select your time zone, and then press ENTER  twice. On the DST screen, select whether to turn DST (Daylight Savings Time) On or Off, and then press ENTER . When done, press ENTER .</p> <p>Manual</p> <p>If you selected Manual, select Date, and then press ENTER . Use the number buttons or the ▲ or ▼ button to set the date. Use the ◀ or ▶ button to move between entry fields. When done, press ENTER . Select Time, and then press ENTER . Set the time in the same fashion. When done, press ENTER . Then, select Next, and then press ENTER . The Setup Complete screen appears.</p>
9	Setup Complete	Review the Setup data, and then press the ENTER  button.

If You Want to Re-run Setup...

 **MENU** → **System** → **Setup** → **ENTER** 

If You Want to Turn the Store Demo Mode On or Off.

To set or unset **Store Demo** mode outside of Setup, press and release the Controller when the power is on. The Function menu screen appears. Push the Controller to the left (to **MENU** (III)) and hold for more than 5 seconds. The **Store Demo** mode is set. To cancel **Store Demo**, bring up the Function menu using the Controller, push the Controller to the right (to **Source** (I)) and hold for more than 5 seconds. See page 13 for information about the Controller.

Changing the Input Source

Source

When you are watching TV and you want to watch a movie on your DVD player or Blu-ray player or switch to your cable box or STB satellite receiver, you need to change the Source.



1. Press the **SOURCE** button on your remote.
2. Select a desired external input source.

■ TV / HDMI1/DVI / HDMI2 / AV / Component

You can only choose external devices that are connected to the TV. In **Source**, connected inputs are highlighted.

How to Use Edit Name

Edit Name lets you associate a device name to an input source. To access **Edit Name**, press the **TOOLS** button when the **Source** is displayed. The following selections appear under **Edit Name**:

■ VCR / DVD / Cable STB / Satellite STB / PVR STB / AV Receiver / Game / Camcorder / PC / DVI PC / DVI Devices / TV / IPTV / Blu-ray / HD DVD / DMA

Select the name of the device connected to each input jack to make your input source selection easier.

If you have connected a PC to the **HDMI IN 1 (DVI)** port with an HDMI cable, select **PC** under **Edit Name** to enter a device name.

If you have connected a PC to the **HDMI IN 1 (DVI)** port with an HDMI to DVI cable, select **DVI PC** under **Edit Name** to enter a device name.

If you connected an AV device to the **HDMI IN 1 (DVI)** port with an HDMI to DVI cable, select **DVI Devices** under **Edit Name** to enter a device name.

Information

You can see detailed information about the connected external device.

How to Navigate Menus

Your TV's Main and Tools menus contains functions that let you control the TV's features. For example, in the Main menu you can change the size and configuration of the picture, its brightness, its contrast and so on. There are also functions that let you control the TV's sound, channel configuration, energy use, and a host of other features. To access the main, on-screen menu, press the **MENU** (■) button on your remote. To access Tools menus, press the **TOOLS** button. Tools menus are available when the **TOOLS** menu icon is displayed on the bottom right of the screen.

The illustration below displays the buttons on the remote you use to navigate the menus and select and adjust different functions.

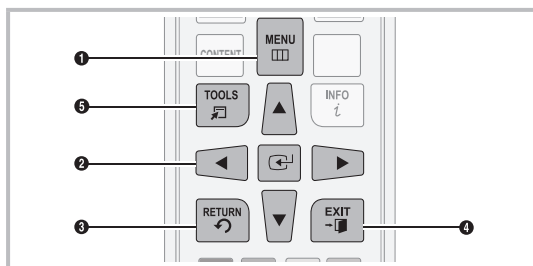

- 1 **MENU** button: Displays the main on-screen menu.
- 2 **ENTER** and **Direction** buttons: Use the **Direction** buttons to move the cursor and highlight an item. Use the **Enter** button to select an item or confirm the setting.
- 3 **RETURN** button: Returns to the previous menu.
- 4 **EXIT** button: Exits the on-screen menu.
- 5 **TOOLS** button: Displays Tools menus when available.

How to Operate the Main Menu (OSD - On Screen Display)

The access steps may differ depending on the menu option you select.

1	MENU	The main menu options appear on the screen: Picture, Sound, Channel, Network, System, Support.
2	▲ / ▼	Select a main menu option on the left side of the screen with the ▲ or ▼ button.
3	ENTER	Press ENTER to access the sub-menus.
4	▲ / ▼	Select the desired submenu with the ▲ or ▼ button.
5	◀ / ▶	Adjust the value of an item with the ◀ or ▶ button. The adjustment in the OSD may differ depending on the selected menu.
6	ENTER	Press ENTER to confirm the selection.
7	EXIT	Press EXIT .

Using the TV's Controller (Panel Key)

The TV's Controller, a small joy stick like button on the bottom right side of the TV, lets you control the TV without the remote control.

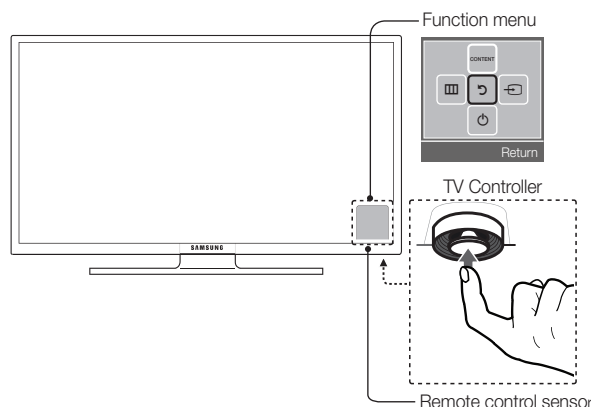

Power on	Turn the TV on by pressing the Controller when the TV is in standby mode.
Adjusting the volume	Adjust the volume by moving the Controller from side to side when the power is on.
Selecting a channel	Select a channel by moving the Controller backwards and forwards when the power is on.
Using the Function menu	To view and use the Function menu, press and release the Controller when the power is on. To close the Function menu, press and release the Controller again.
Selecting Contents Home	With the Function menu visible, select CONTENT by moving the Controller backwards. The Contents Home main screen appears. Select a media source by moving the Controller back and forth, and then pressing the Controller.
Selecting the Menu (III)	With the Function menu visible, select the Menu (III) by moving the Controller to the left. The OSD (On Screen Display) Menu appears. Select an option by moving the Controller to the right. Move the Controller to the right or left, or backwards and forwards to make additional selections. To change a parameter, select it, and then press the Controller.
Selecting a Source (SRC)	With the Function menu visible, open the Source (SRC) by pushing the Controller to the right. The Source screen appears. To select a source, move the Controller back and forth. When the source you want is highlighted, press the Controller.
Power Off (OFF)	With the Function menu visible, select Power Off (OFF) by pulling the Controller forwards, and then press the Controller.

To close the Menu, Contents Home, or Source, press the Controller for more than 1 second.

When selecting the function by moving the controller to the up/down/left/right directions, be sure not to press the controller. If you press it first, you cannot operate it to move the up/down/left/right directions.

Standby mode

Your TV enters Standby mode when you turn it off and continues to consume a small amount of electric power. To be safe and to decrease power consumption, do not leave your TV in standby mode for long periods of time (when you are away on vacation, for example). It is best to unplug the power cord.

Using Contents Home

Contents Home provides easy, on-screen access to four functions that let you manage and access channels, set favorite channels, access photos, videos, or music on USB devices, cameras, and PCs, select video sources, and set the TV to turn on automatically when a show you want to watch is on. The four functions are listed below:

- **Channel List:** Lets you manage channels, select favorite channels, and delete channels from the Added Channel list (the channels that appear when you press the CH button).
- **AllShare Play:** Lets you access, view, or play photos, videos, or music located on USB devices, digital cameras, cell phones, and PCs. PCs and cell phones can be accessed wirelessly, through your wireless network.
- **Schedule Manager:** Lets you schedule shows and channels for viewing. When a show or channel is scheduled, the TV automatically turns on at the set time and changes the channel to the selected channel.
- **Source:** Lets you select a connected external video source to view.

To access **Contents Home**, press the **CONTENT** button on your remote.

For more information about **Contents Home**, see the e-Manual.

Installing the Wall Mount (Optional)



Wall or Ceiling Mounting

If you mount this product on a wall, it should be mounted only as recommended by the manufacturer. Unless it is correctly mounted, the product may slide or fall, causing serious injury to a child or adult, and serious damage to the product.

Installing the Wall Mount Kit

The wall mount kit (sold separately) lets you mount the TV on the wall. For detailed information about installing the wall mount, see the instructions provided with the wall mount. Contact a technician for assistance when installing the wall mount bracket. Samsung Electronics is not responsible for any damage to the product or injury to yourself or others if you elect to install the wall mount on your own.

To order the wall mount, contact Samsung Customer Care at 1-800-SAMSUNG (1-800-726-7864).

Wall Mount Kit Specifications (VESA)

Install your wall mount on a solid wall perpendicular to the floor. Before attaching the wall mount to surfaces other than plaster board, please contact your nearest dealer for additional information. If you install the TV on a ceiling or slanted wall, it may fall and result in severe personal injury.

NOTE

- Standard dimensions for wall mount kits are shown in the table below.
- Samsung wall mount kits contain a detailed installation manual and all parts necessary for assembly are provided.
- Do not use screws that do not comply with the VESA standard screw specifications.
- Do not use screws that are longer than the standard length or do not comply with the VESA standard screw specifications. Screws that are too long may cause damage to the inside of the TV set.
- For wall mounts that do not comply with the VESA standard screw specifications, the length of the screws may differ depending on the wall mount specifications.
- Do not fasten the screws too firmly. This may damage the product or cause the product to fall, leading to personal injury. Samsung is not liable for these kinds of accidents.
- Samsung is not liable for product damage or personal injury when a non-VESA or non-specified wall mount is used or the consumer fails to follow the product installation instructions.
- Do not mount the TV at more than a 15 degree tilt.
- Always have two people mount the TV on a wall.

Product Family	TV size in inches	VESA screw hole specs (A * B) in millimeters	Standard Screw	Quantity
LED-TV	32~40	200 X 200	M6	4
	46~60	400 X 400	M8	

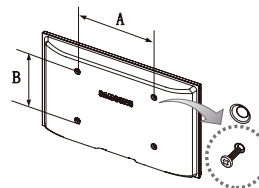

 Remove the screws in the mounting holes before you install the wall mount.



Do not install your Wall Mount Kit while your TV is turned on. It may result in personal injury due to electric shock.

















Configuring Network Connections after Initial Setup

If you did not configure the network connections during initial setup, you can configure them through the Network Settings option in the Main menu.

Configuring a Wireless Network Connection

The instructions below are for wireless networks that use the Dynamic Host Configuration Protocol (DHCP) to configure network connections automatically. Most wireless networks use DHCP. If you have a Static IP network, see the e-Manual for configuration instructions.



To configure the network connection for a network that uses DHCP, follow these steps:

1. Connect your TV to your network as shown in the illustration on page 7.
2. Turn on your TV, press the **MENU** button on your remote, and then select **Network** → **Network Settings**.
3. Select **Start**, and then press **ENTER**  button.
4. The Network function searches for available wireless network. When done, it displays a list of the available networks.
5. In the list of networks, press the **▲** or **▼** button to select a network, select **Next**, and then press **ENTER**  button.
 -  If you have a WPS(PBC) compatible router, select WPS(PBC) instead, press **ENTER** , and then follow the directions on the screen. When done, go to Step 8.
6. Enter your network security key or **WPS PIN** using the remote.
 -  Enter numbers by pressing the number buttons on your remote.
 -  Enter letters by selecting a letter using the **▲/▼/◀/▶** buttons, and then pressing **ENTER** .
 -  To display capital letters (or redisplay small letters if capital letters are displayed), select **Shift**, and then press **ENTER** .
 -  To display symbols and punctuation, select **★**, and then press **ENTER** . To redisplay letters, select **Shift**, and then press **ENTER** .
7. When done, use the **▲/▼/◀/▶** buttons to select **Next** if you have entered a security key or **WPS PIN** if you have entered a **WPS PIN**, and then press **ENTER** .
8. The TV checks the wireless connection. If the connection is successful, the "Wireless network and Internet connection complete" message appears. The cursor jumps to **Next**. Press **ENTER** .
-  For more detailed information, see "Setting the Wireless Network" in the e-Manual.
-  If you want to configure the connection manually, select **IP Settings** on the Network Connection screen. Set **IP Setting** to **Enter manually**, and then enter the **IP Address**, **Subnet Mask**, **Gateway**, and **DNS Server** manually.

Configuring a Wired Network Connection

Most home networks use the Dynamic Host Configuration Protocol (DHCP) to configure network connections. Home networks that support DHCP automatically provide the IP address, subnet mask, gateway, and DNS values your TV needs to access the Internet so you don't have to enter them manually. If you have a Static IP network, see the e-Manual for configuration instructions.

To configure the network connection for a wired network that uses DHCP, follow these steps:

1. Connect your TV to your network as shown in one of the illustrations on page 8.
2. Turn on your TV, press the **MENU** button on your remote, and then select **Network** → **Network Settings**. The **Network Settings** screen will appear.
3. Select **Start**, and then press **ENTER**  button.
4. The Network Connection screen appears, and verifies the network connection. Network set up is complete.
 -  If your TV cannot acquire network connection values automatically or if you want to set the connection manually, select **IP Settings** on the network test screen. Set **IP Setting** to **Enter manually**, and then enter the **IP Address**, **Subnet Mask**, **Gateway**, and **DNS Server** manually.
 -  For more detailed information, see "Setting the Wired Network" in the e-Manual.



How to View the e-Manual

E-MANUAL



You can find instructions for your TV's features in the e-Manual in your TV. To use, press the **E-MANUAL** button on your remote. Move the cursor using the right/left buttons to highlight a main category. Use the up/down buttons to select a topic, and then press the **ENTER**  button. The e-Manual displays the page you want to see. To change pages, use the right/left buttons.

You can also access the e-Manual through the menu:

 **MENU**  **Support**  **e-Manual** 



 If you want to return to the e-Manual, press the **E-MANUAL** button on your remote.

 You can not use the **Try Now** function if the menu is not activated.

Screen Display

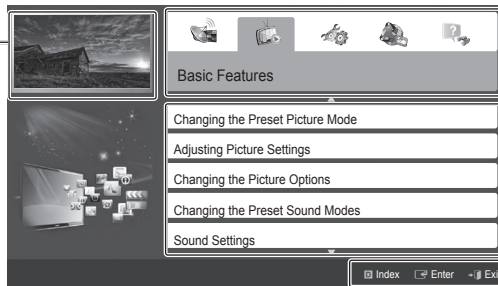
TV Screen: Displays the program, movie, video, etc. you are currently watching.





The category list. Press  or  button to select the category you want.

Displays the sub-menu list. Use the arrow buttons on your remote to move the cursor. Press the **ENTER**  button to select the sub-menu you want.

Operation Buttons:

 **Blue (Index)**: Displays index screen.

 **Enter**: Select a category or sub-menu.

 **Exit**: Exit the e-Manual.

How to toggle between an e-Manual topic and the corresponding OSD menu(s).

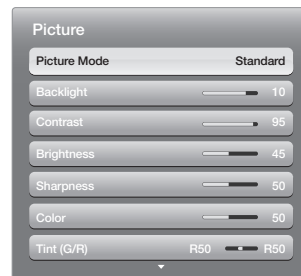
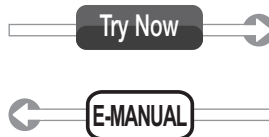
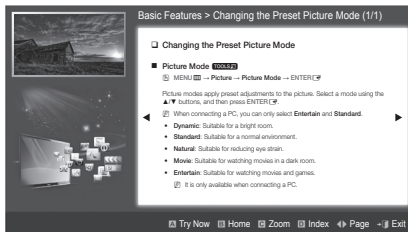



 This function is not enabled in some menus.

Method 1

1. If you want to use the menu that corresponds to an e-Manual topic, press the red button to select **Try Now**.
2. To return to the e-Manual screen, press the **E-MANUAL** button.

Method 2

1. Press the **ENTER**  button when a topic is displayed. **"Do you want to execute this?"** appears. Select **Yes**, and then press the **ENTER**  button. The OSD window appears.
2. To return to the e-Manual screen, press the **E-MANUAL** button.

Viewing the Contents

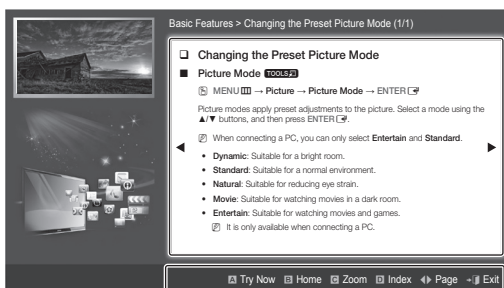

Contents Area: Contains the topic contents if you selected a sub-menu. To move to the previous or next page, press the ◀ or ▶ button.

Operation Buttons:

- ▲ Red (**Try Now**): Displays the OSD menu that corresponds to the topic. To return to the e-Manual screen, press the E-MANUAL button.
- Green (**Home**): Moves to the e-Manual home screen.
- Yellow (**Zoom**): Magnifies a screen.
- Blue (**Index**): Displays the Index screen.
- ◀▶ (Page): Moves to previous or next page.
- (Exit): Exit the e-Manual.

Using the Zoom mode

When you are viewing an e-Manual instruction page, press the ■ Yellow (**Zoom**) to magnify the screen. You can scroll through the magnified screen by using the ▲ or ▼ buttons.

✎ To return to the screen to normal size, press the RETURN button.

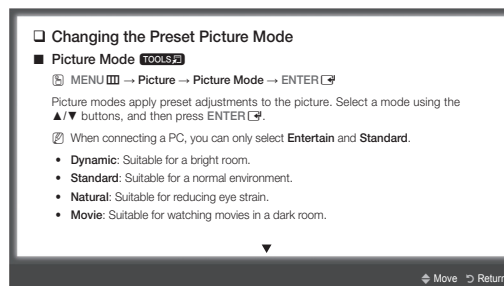

How to search for a topic on the index page

1. Press the Blue (**Index**) button on the remote. The Index screen appears.
2. To search for a topic, press the left or right arrow button to select a letter. The Index displays a list of topics and keywords that begin with the letter you selected.
3. Press the up or down arrow button to select a topic or keyword you want, and then press the ENTER button to select a topic you want to see.
4. The e-Manual page with the topic appears.

✎ To close the **Index** screen, press the RETURN button.

Troubleshooting

If the TV seems to have a problem, first review this list of possible problems and solution. Also review the Troubleshooting Section in the e-Manual. If none of the troubleshooting tips apply, visit www.samsung.com/support or call Samsung customer Service at 1-800-SAMSUNG(1-800-726-7864).

Issues	Solutions and Explanations
Flickering and Dimming	<p>If your Samsung Television is flickering or dimming sporadically, you may need to disable some of its energy efficient features like the Eco Sensor or the Energy Saving feature. If you follow below step with your remote, you can turn these features off or on.</p> <ul style="list-style-type: none"> • Energy saving: User Menu → System → Eco Solution → Energy Saving • Eco Sensor: User Menu → System → Eco Solution → Eco Sensor
Component Connections / Screen Color	<p>If you find that the color on your Samsung television's screen is not correct or black and white, first run a Self Diagnosis on the TV to make sure there are no device issues.</p> <ul style="list-style-type: none"> • Self Diagnosis : User Menu → Support → Self Diagnosis → Picture Test <p>If the problem does not appear in the Test Picture, try making sure :</p> <ul style="list-style-type: none"> • Your connections are all consistent. For example, if you've used the AV In jack on your TV, make sure you have used the AV Out jack on your video source. • You have connected your devices to the correct jacks. For example, if you use the Component jacks, labeled Pb, Pr, and Y, to connect your TV and video source, make sure you have connected the blue Pb jack on the video source to the blue Pb jack on the TV, the red Pr jack on the source to the red Pr jack on the TV, and the yellow Y jack on video source to the yellow Y jack on the TV..
Screen Brightness	<p>If you find that the colors on your Samsung TV are correct but just a little too dark or bright, try adjusting the following settings in the Picture option of the Main menu:</p> <ul style="list-style-type: none"> • Backlight, Contrast, Brightness, Sharpness, Color, Tint and so on.
Unwanted Powering Off	<p>If your Samsung TV appears to turn off by itself, there may be an issue with either your Timer settings or your Eco friendly No Signal Power Off feature.</p> <p>First make sure the Sleep Timer is not accidentally set. The sleep timer turns the TV off after a certain period of time.</p> <ul style="list-style-type: none"> • Sleep Timer : User Menu → System → Time → Sleep Timer <p>If the Sleep Timer is not activated, you may have engaged the No Signal Power Off or Auto Power Off feature.</p> <ul style="list-style-type: none"> • No Signal Power Off : User Menu → System → Eco Solution → No Signal Power Off • Auto Power Off : User Menu → System → Eco Solution → Auto Power Off
Trouble Powering On	<p>Before you turn the TV on, find the red light on the right or left bottom of your TV. Press the power button on the TV or remote and the light should blink about 5 times before the TV turns on.</p> <p>If you find that you are having trouble powering on your Samsung television, there are a number of things to check before making a call to the service department.</p> <ul style="list-style-type: none"> • If you happen to be using the TV as a monitor and the stand-by light only blinks for a few seconds when you press the power button, your PC is in sleep mode. To take your PC out of sleep mode, press a key on your keyboard or move the mouse. Then try turning your TV on. <p>If you're sure your power cord, remote control, and PC are functioning properly, you may be having a cable issue. If you have a cable or satellite box, your TV may appear to be off because the cable or satellite box is not outputting a signal. To test the signal output of your cable or satellite box, press the guide or info button on the cable or satellite box remote control. If the screen displays the guide or info data, the problem is caused by the box.</p>
Cannot Find a Channel	<ul style="list-style-type: none"> • Re-run Setup (Go to Menu - System - Setup) or run Auto Program. (Go to MENU - Channel - Auto Program).

 For detailed troubleshooting information, watch the troubleshooting videos at www.samsung.com/spn

Issues	Solutions and Explanations
The TV Won't Turn On.	<ul style="list-style-type: none"> • Make sure the AC power cord is securely plugged in to the wall outlet and the TV. • Make sure the wall outlet is working. • Try pressing the POWER button on the TV to make sure the problem is not the remote. If the TV turns on, refer to "The remote control does not work" below.
There is no picture/video.	<ul style="list-style-type: none"> • Check the cable connections. Remove and reconnect all cables connected to the TV and external devices. • Set the video outputs of your external devices (Cable/Sat Box, DVD, Blu-ray etc) to match the TV's input connections. For example, if an external device's output is HDMI, it should be connected to an HDMI input on the TV. • Make sure your connected devices are powered on. • Be sure to select the correct input source by pressing the SOURCE button on the remote control. • Reboot the connected device by unplugging it, and then reconnecting the device's power cable.
The Remote Control Does Not Work.	<ul style="list-style-type: none"> • Replace the remote control batteries. Make sure the batteries are installed with their poles (+/-) in the correct direction. • Clean the sensor's transmission window on the remote. • Try pointing the remote directly at the TV from 5~6 feet away.
The cable/set top box remote control doesn't turn the TV on or off, or adjust the volume.	<ul style="list-style-type: none"> • Program the Cable/Set remote control to operate the TV. Refer to the Cable/Set Top Box user manual for the SAMSUNG TV code.

 This TFT LED panel uses a panel consisting of sub pixels which require sophisticated technology to produce. However, there may be a few bright or dark pixels on the screen. These pixels will have no impact on the performance of the product.

 Some functions and pictures shown in this manual are available on specific models only.

 To keep your TV in optimum condition, upgrade to the latest firmware on the Samsung web site by USB (Go to samsung.com → Support → Downloads).

Licenses



List of Features

- **3D:** This exciting new feature enables you to view 3D content.
- **AllShare Play:** AllShare Play lets you access, view, or play photos, videos, or music located on USB devices, digital cameras, cell phones, and PCs. PCs, cell phones, and other compatible devices can be accessed wirelessly, through your wireless network.

Securing the TV to the Wall



Caution: Pulling, pushing, or climbing on the TV may cause the TV to fall. In particular, ensure your children do not hang over or destabilize the TV. Doing so may cause the TV to tip over, causing serious injuries or death. Follow all safety precautions provided in the included Safety Flyer with your TV. For added stability and safety, you can purchase and install the anti fall device as described below.

The TV-Holder Kit (Sold Separately):

The parts below are included in the TV Holder kit. In addition, you need to provide a wood screw, a screw and molly, or other screw appropriate for the wall or cabinet you intend to secure the TV-Holder string to. We recommend a size M4xL20 wood screw.



TV-Holder (BN96-15753A)







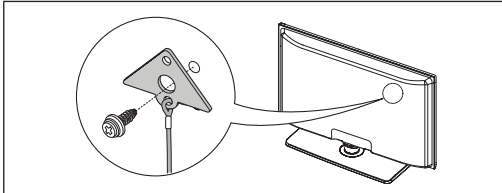

Screw (M8 X L19)

Installing the TV-Holder

1. Remove the screw attached to the back of your TV, and then connect the TV-Holder to the TV with the screw included in the TV-Holder Kit that is designated for your TV.

 Make sure to use only the appropriate supplied screw. If you use a different screw, you can damage your TV.



2. Firmly fasten the screw you provided (size M4 x L20 or similar) to the wall or cabinet where the TV is to be installed.
 -  If you fasten the screw to the wall, we recommend you drive the screw into a stud. If that is not possible, use a molly to anchor the screw.
3. Tie the TV-Holder cord to the screw fastened to the wall or cabinet so that the TV is fixed. See the illustrations below.
 -  Install the TV close to the wall so that it does not fall.
 -  When attaching the TV-Holder cord to the wall, tie the cord level with the ground or slanted downwards for safety purposes.
 -  Check the cord occasionally to make sure it is secure.
 -  Before moving the TV, separate the connected cord first.

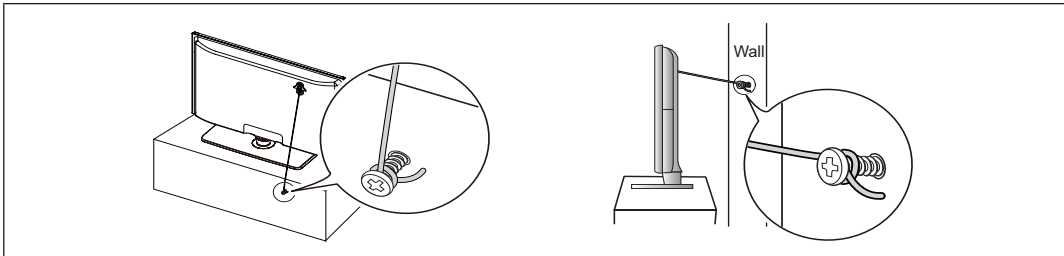





4. Verify all connections are properly secured. Periodically check the connections for any sign of fatigue or failure. If you have any doubt about the security of your connections, contact a professional installer.

To purchase the TV-Holder Kit, contact Samsung Customer Care

- In the United States: 1-800-SAMSUNG (1-800-726-7864)
- In Canada: 1-800-SAMSUNG (1-800-726-7864)

Specifications

Display Resolution	1920 X 1080	
Environmental Considerations		
Operating Temperature	50°F to 104°F (10°C to 40°C)	
Operating Humidity	10% to 80%, non-condensing	
Storage Temperature	-4°F to 113°F (-20°C to 45°C)	
Storage Humidity	5% to 95%, non-condensing	
Model Name	UN40EH6030	UN46EH6030 / UN46EH6070
Screen Size (Diagonal)	40" Class (40.0" measured diagonally)	46" Class (45.9" measured diagonally)
Sound (Output)	10W X 2	
Dimensions (W x H x D)		
Body	36.5 X 21.5 X 3.6 inches (927.5 X 548.0 X 93.1 (mm))	41.7 X 24.5 X 3.7 inches (1060.0 X 622.5 X 96.2 (mm))
With stand	36.5 X 23.9 X 8.9 inches (927.5 X 607.2 X 227.6 (mm))	41.7 X 26.8 X 10.9 inches (1060.0 X 681.1 X 277.6 (mm))
Weight		
Without Stand	19.6 lbs (8.9 kg)	24.9 lbs (11.3 kg)
With Stand	24.0 lbs (10.9 kg)	29.3 lbs (13.3 kg)
Model Name	UN55EH6030 / UN55EH6070	
Screen Size (Diagonal)	55" Class (54.6" measured diagonally)	
Sound (Output)	10W X 2	
Dimensions (W x H x D)		
Body	49.2 X 28.7 X 3.7 inches (1251.4 X 730.1 X 94.4 (mm))	
With stand	49.2 X 31.0 X 8.9 inches (1251.4 X 789.6 X 227.6 (mm))	
Weight		
Without Stand	39.6 lbs (18.0 kg)	
With Stand	45.4 lbs (20.6 kg)	



-  Design and specifications are subject to change without prior notice.
-  This device is a Class B digital apparatus.
-  For information about the power supply, and more about power consumption, refer to the label attached to the product.
-  Typical power consumption is measured according to Energy Star Program requirements for Televisions.

Dispose unwanted electronics through an approved recycler.
 To find the nearest recycling location, go to our website:
www.samsung.com/recyclingdirect Or call, (877) 278 - 0799

Supported Video Formats

File Extension	Container	Video Codec	Resolution	Frame rate (fps)	Bit rate (Mbps)	Audio Codec
*.avi	AVI MKV ASF MP4 3GP VRO VOB PS TS	DivX 3.11/4.x/5.x/6.x	1920 x 1080	6-30	30	AC3 LPCM ADPCM (IMA, MS) AAC HE-AAC WMA DD+ MPEG(MP3) DTS Core G.711(A-Law, μ-Law)
*.mkv		MPEG4 SP/ASP				
*.asf		H.264 BP/MP/HP				
*.wmv						
*.mp4						
*.3gp						
*.vro						
*.mpg		Motion JPEG	640 x 480	8		
*.mpeg						
*.ts		Window Media Video v9	1920 x 1080	30		
*.tp						
*.trp						
*.mov						
*.flv		MPEG2				
*.vob						
*.svi						
*.divx		MPEG1				

Storage and Maintenance

-  If a sticker was attached to the TV screen, some debris can remain after you remove the sticker. Please clean the debris off before watching TV.
-  The exterior and screen of the product can get scratched during cleaning. Be sure to wipe the exterior and screen carefully using the cloth provided or a soft cloth to prevent scratches.

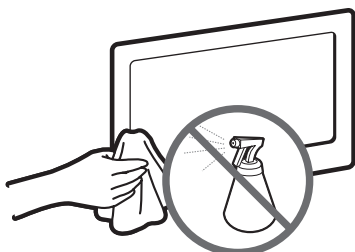

Do not spray water directly onto the product. Any liquid that goes into the product may cause a failure, fire, or electric shock.

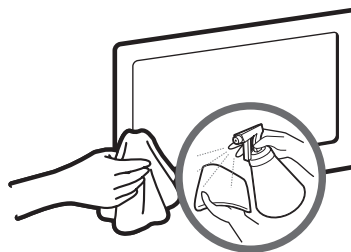

Clean the product with a soft cloth dampened with a small amount of water. Do not use a flammable liquid (e.g. benzene, thinners) or a cleaning agent.

JACK PANEL DETAIL / REAR VIEW

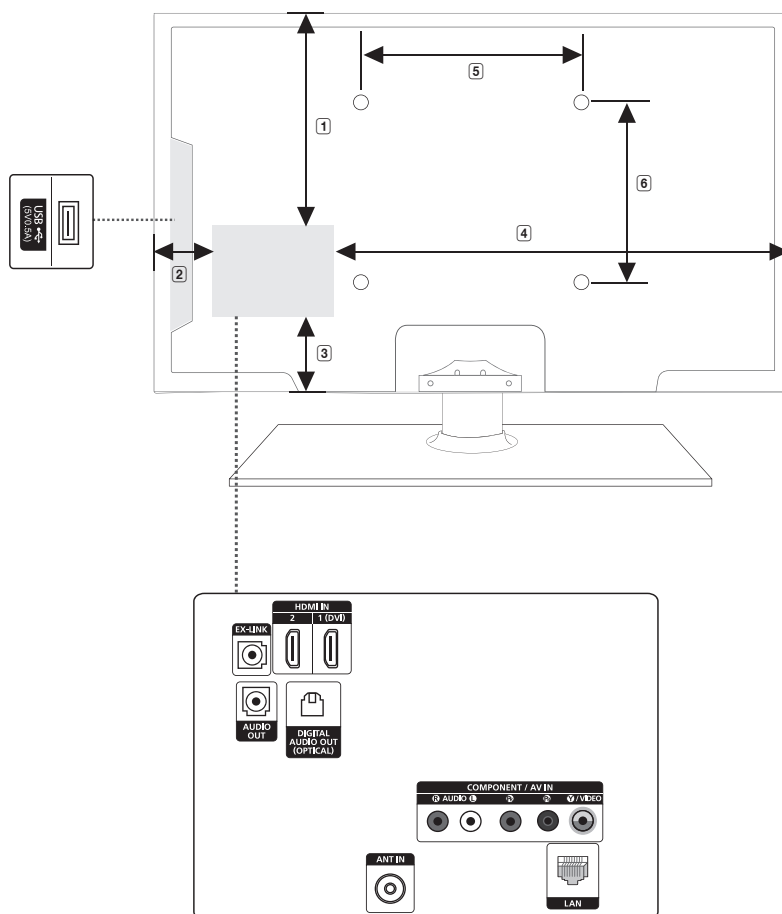

(Unit: inches)

Model name	1	2	3	4	5	6
UN40EH6030	9.6	5.8	6.0	24.1	7.8	7.8
UN46EH6030/UN46EH6070	11.2	5.3	7.3	29.8	15.7	15.7
UN55EH6030/UN55EH6070	15.6	6.2	7.8	36.4	15.7	15.7

NOTE: All drawings are not necessarily to scale. Some dimensions are subject to change without prior notice. Refer to the dimensions prior to performing installation of your TV. Not responsible for typographical or printed errors.

© 2012 Samsung Electronics America, Inc