



Contact SAMSUNG WORLDWIDE

If you have any questions or comments about your Samsung TV, please contact the SAMSUNG customer care center.

Country	Customer Care Center ☎	Web Site	Address
CANADA	1-800-SAMSUNG (726-7864)	www.samsung.com	Samsung Electronics Canada Inc., Customer Service 55 Standish Court Mississauga, Ontario L5R 4B2 Canada
U.S.A	1-800-SAMSUNG (726-7864)	www.samsung.com	Samsung Electronics America, Inc. 85 Challenger Road Ridgefield Park, NJ 07660



SERIES **6+**
6500

Plasma TV

user manual

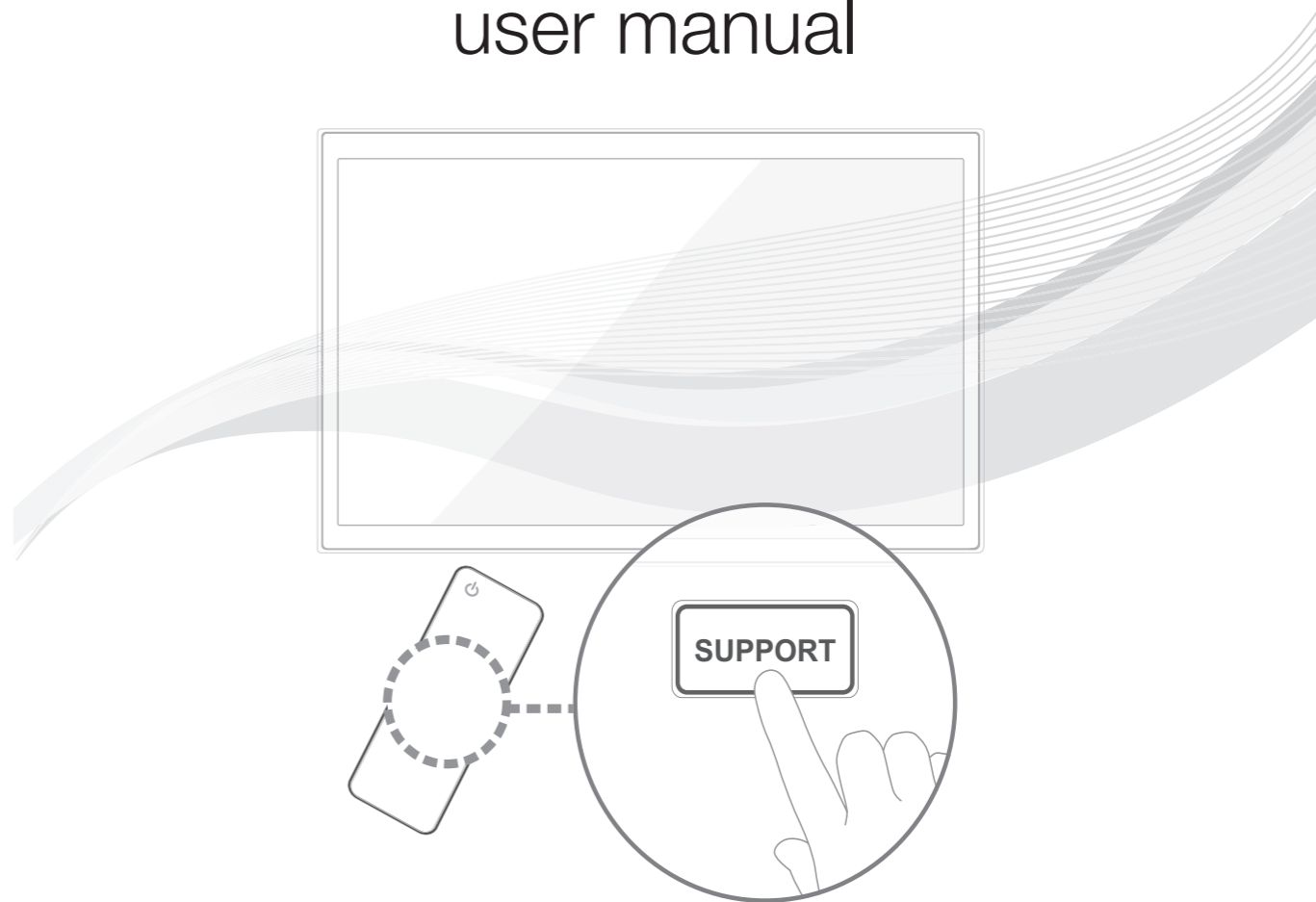

Thank you for purchasing this Samsung product.
To receive more complete service, please register
your product at

www.samsung.com/register

Model _____ Serial No. _____

☎ If you have any questions, please call us at 1-800-SAMSUNG (1-800-726-7864) for assistance.



BN68-04195A-00

A detailed User's Manual is built into your TV. For more information about how to view this e-Manual see page 32.

Figures and illustrations in this User Manual are provided for reference only and may differ from actual product appearances. Product design and specifications may be changed without notice.

Important Warranty Information Regarding

Wide screen format PDP Displays (with 16:9 aspect ratios, the ratio of the screen width to height) are primarily designed to view wide screen format full-motion video. The images displayed on them should primarily be in the wide screen, 16:9 ratio format, or expanded to fill the screen, if your model offers this feature, with the images constantly in motion. Displaying stationary graphics and images on the screen, such as the dark sidebars on non-expanded standard format television video and programming, should be limited to no more than 5% of the total television viewing per week.

Additionally, viewing other stationary images and text such as stock market reports, video game displays, station logos, web sites or computer graphics and patterns, should be limited as described above for all televisions. Displaying stationary images that exceed the above guidelines can cause uneven aging of PDP Displays that leave subtle, but permanent burned-in ghost images in the PDP picture. To avoid this, vary the programming and images, and primarily display full screen moving images, not stationary patterns or dark bars. On PDP models that offer picture sizing features, use these controls to view different formats as a full screen picture.

Be careful about the television formats you select and the length of time you view them. Uneven PDP aging as a result of format selection and use, as well as burned in images, are not covered by your Samsung limited warranty.

- **SAMSUNG ELECTRONICS NORTH AMERICAN LIMITED WARRANTY STATEMENT**

Subject to the requirements, conditions, exclusions and limitations of the original Limited Warranty supplied with Samsung Electronics (SAMSUNG) products, and the requirements, conditions, exclusions and limitations contained herein, SAMSUNG will additionally provide Warranty Repair Service in the United States on SAMSUNG products purchased in Canada, and in Canada on SAMSUNG products purchased in the United States, for the warranty period originally specified, and to the Original Purchaser only.

The above described warranty repairs must be performed by a SAMSUNG Authorized Service Center. Along with this Statement, the Original Limited Warranty Statement and a dated Bill of Sale as Proof of Purchase must be presented to the Service Center. Transportation to and from the Service Center is the responsibility of the purchaser. Conditions covered are limited only to manufacturing defects in material or workmanship, and only those encountered in normal use of the product.

Excluded, but not limited to, are any originally specified provisions for, in-home or on-site services, minimum or maximum repair times, exchanges or replacements, accessories, options, upgrades, or consumables.

For the location of a SAMSUNG Authorized Service Center, please call toll-free:

– In the United States : 1-800-SAMSUNG (1-800-726-7864)

– In Canada : 1-800-SAMSUNG

User Instructions

- **Screen Image retention**

Do not display a still image (such as on a video game) on the plasma display panel for more than several minutes as it can cause screen image retention. This image retention is also known as 'screen burn'. To avoid such image retention, refer to e-Manual to reduce the degree of brightness and contrast of the screen when displaying a still image.

- **Heat on the top of the Plasma TV**

The top side of the product may be hot after long periods of use as heat dissipates from the panel through the vent hole in the upper part of the product. This is normal and does not indicate any defect or operation failure of the product. However, children should be prevented from touching the upper part of the TV.

- **The product is making a 'cracking' noise.**

A 'cracking' noise may occur when the product contracts or expands due to a change in the surrounding environment such as temperature or humidity. This is normal and not a defect of the unit.

- **Cell Defects**

Your plasma TV has a panel containing 2,360,000 (HD-level) to 6,221,000 (FHD-level) pixels which require sophisticated technology to produce. However, there may be a few bright or dark pixels on the screen. These pixels will have no impact on the performance of the product.

- **Avoid operating the TV at temperatures below 41°F (5°C)**

- **A still image displayed too long may cause permanent damage to the PDP Panel.**



Watching the Plasma TV in 4:3 format for a long period of time may leave traces of borders displayed on the left, right and center of the screen caused by the difference of light emission on the screen. Playing a DVD or a game console may cause similar effects to the screen. Damages caused by the above effect are not covered by the Warranty.

- **After-images on the Screen.**

Displaying still images from Video games or a PC for longer than a certain period of time may produce partial after-images.

To prevent this effect, reduce the 'brightness' and 'contrast' when displaying still images for a long time.

- **Warranty**

Warranty does not cover any damage caused by image retention. Burn-in is not covered by the warranty.

- **Caution**



The glass screen of your PDP TV can break if you accidentally drop the TV. Handle the TV with care.



When moving the TV, always have two or more people pick it up and carry it as a safety precaution. Do not lay the TV flat on its face or back.

Your Samsung Plasma TV is a high quality television that has been carefully packaged to protect the integrity of its glass panel and component parts during shipment. It is, nonetheless, a fragile piece of electronics that requires careful handling. Refrain from putting undue stress on any part of the packaging when shipping or unpacking the TV. Use care when installing the TV. Avoid placing the TV in a location where it may be struck, exposed to sharp impacts, or fall. Panel breakage caused by a fall or impact strike is not covered under the manufacturer's warranty.

List of Features

- **3D:** This exciting new feature enables you to view 3D content.
- **SMART HUB:** Your gateway to all your content, integrated in one place.
 - Provides diverse entertainment choices.
 - Lets you control your entertainment life with an easy-to-use, user friendly user interface.
 - Gives you easy access to diverse apps, with more being added every day.
 - Lets you customize your TV by grouping and sorting apps to your taste.
- **AllShare Play:** Lets you access, view, or play photos, videos, or music located on USB devices, digital cameras, cell phones, and PCs. PCs and cell phones can be accessed wirelessly, through your wireless network.
- **Anynet+ (HDMI-CEC):** Allows you to control all connected Samsung devices that support Anynet+ with your Samsung TV's remote.
- **e-Manual:** Provides a detailed, on-screen user's manual that's built into your TV. (page 32)

Accessories and Cables

-  Please make sure the following items are included with your TV. If any items are missing, contact your dealer.
-  The items' colors and shapes may vary depending on the model.
-  Make sure that there are no accessories hidden behind or under packing materials after you open the box.

- Remote Control (AA59-00559A) & Batteries (AAA x 2)
- Warranty Card / Safety Guide
- User Manual
- Cleaning Cloth (BN63-01798B)
- 3D Active Glasses
- Power Cord

Input Cables (Sold Separately)

You will need one or more of these cables to connect your TV to your antenna or cable outlet and your peripheral devices (Blu-ray players, DVD players, etc.)

To purchase the RS232 cable, contact www.SamsungParts.com.



RS232 (AA39-00311A)



HDMI



HDMI-DVI



Audio



Component







Composite (AV)

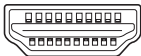
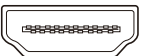

Coaxial (RF)

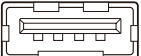
 Make sure you have the correct cable before plugging it in. Illustrations of common plugs and jacks are below.

	Cable Plugs	Ports / Jacks
HDMI		
USB		
Optical		



Warning

Do not plug cables in upside down.
Be sure to check the orientation of the plug before plugging it in.

Providing Proper Ventilation for Your TV

When you install your TV, maintain a distance of at least 4 inches between the TV and other objects (walls, cabinet sides, etc.) to ensure proper ventilation. Failing to maintain proper ventilation may result in a fire or a problem with the product caused by an increase in its internal temperature.

✎ Whether you install your TV using a stand or a wall-mount, we strongly recommend you use parts provided by Samsung Electronics only.

- If you use parts provided by another manufacturer, it may cause difficulties with the product or result in injury caused by the product falling.

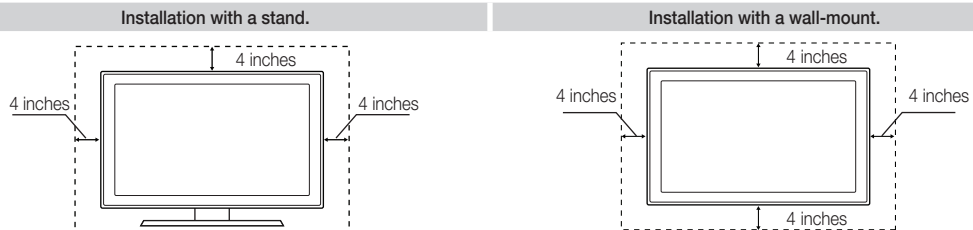

Other Warnings

- ✎ The actual appearance of the TV may differ from the images in this manual, depending on the model.
- ✎ Be careful when you touch the TV. Some parts can be somewhat hot.

Installing the Stand

Stand Parts:

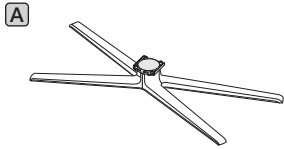

Stand x 1

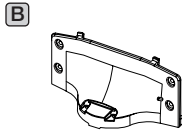

Guide Stand x 1

C  x4 (M4 X L10)

D  x4 (M4 X L12)

Screws x 8

Follow the steps below to connect the TV to the stand. For more detailed instructions, see the separate stand installation guide.

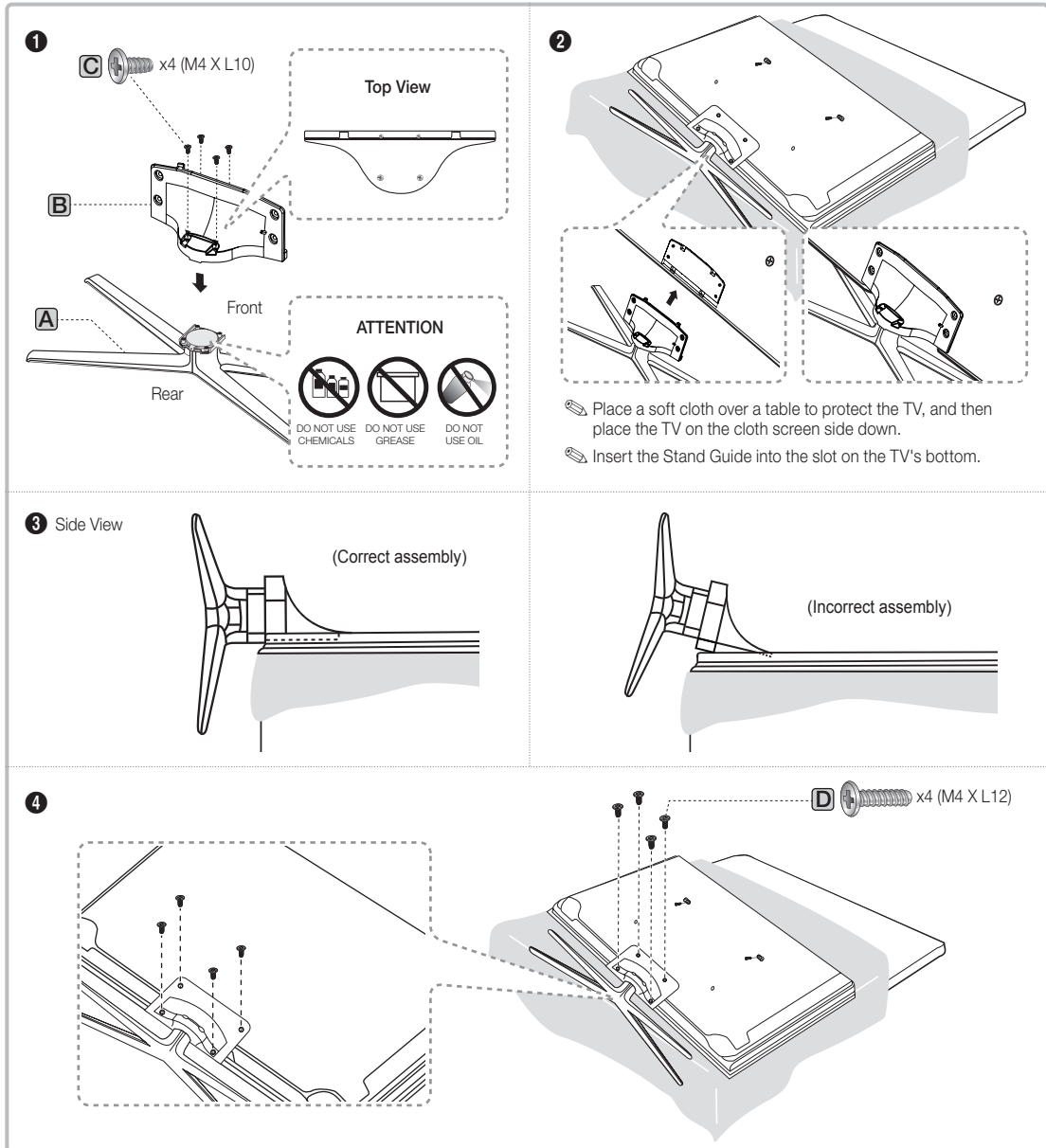

NOTE

- Make sure to distinguish between the front and back of each component when assembling them.
- Make sure that at least two people lift and move the TV.
- Stand the product up before you tighten the screws. If you tighten the screws with the TV lying down, it may lean to one side when you stand it up.

⚠ Do not insert your fingers into the stand base slot of the TV when installing the stand base.

Installing the Wall Mount (Optional)



Wall or Ceiling Mounting

If you mount this product on a wall, it should be mounted only as recommended by the manufacturer. Unless it is correctly mounted, the product may slide or fall, causing serious injury to a child or adult, and serious damage to the product.

Installing the Wall Mount Kit

The wall mount kit (sold separately) lets you mount the TV on the wall.

For detailed information about installing the wall mount, see the instructions provided with the wall mount. We recommend you contact a technician for assistance when installing the wall mount bracket. We do not advise you to do it yourself. Samsung Electronics is not responsible for any damage to the product or injury to yourself or others if you elect to install the wall mount on your own.

To order the wall mount kit, contact Samsung Customer Care at 1-800-SAMSUNG (1-800-726-7864).

VESA Wall Mount Kit Notes and Specifications

Install your wall mount on a solid wall perpendicular to the floor. Before attaching the wall mount to surfaces other than plaster board, please contact your nearest dealer for additional information. If you install the TV on a ceiling or slanted wall, it may fall and result in severe personal injury.

NOTE

- Standard dimensions for wall mount kits are shown in the table below.
- Samsung wall mount kits contain a detailed installation manual and all parts necessary for assembly are provided.
- Do not use screws that do not comply with the VESA standard screw specifications.
- Do not use screws that are longer than the standard length or do not comply with the VESA standard screw specifications. Screws that are too long may cause damage to the inside of the TV set.
- For wall mounts that do not comply with the VESA standard screw specifications, the length of the screws may differ depending on the wall mount specifications.
- Do not fasten the screws too firmly. This may damage the product or cause the product to fall, leading to personal injury. Samsung is not liable for these kinds of accidents.
- Samsung is not liable for product damage or personal injury when a non-VESA or non-specified wall mount is used or the consumer fails to follow the product installation instructions.
- Do not mount the TV at more than a 15 degree tilt.
- Always have two people mount the TV on a wall.

Product Family	TV size in inches	VESA screw hole specs (A * B) in millimeters	Standard Screw	Quantity
PDP TV	43 – 51	400 X 400	M8	4
	60 – 64	600 X 400		

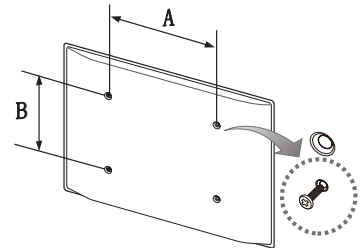

Remove the screws in the mounting holes before you install the wall mount.



Do not install your Wall Mount Kit while your TV is turned on. It may result in personal injury due to electric shock.

Installing a Wall Mount from Another Manufacturer

To install a wall-mount from another manufacturer, use the Holder-Ring.

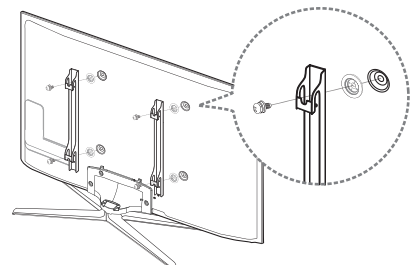

Connecting the Power Cord and the Antenna or Cable Connection

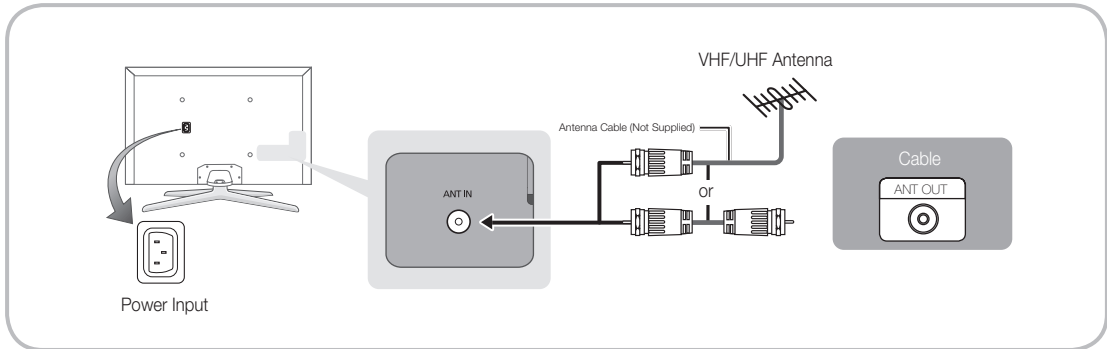

- ✎ Plug the power cord into a wall outlet only after you have made all other connections.
- ✎ If you are connecting your TV to a cable or satellite box using HDMI, Component, or Composite connections, you do not need to connect the ANT IN jack to an antenna or a cable connection.
- ✎ The Plasma TV may interfere with an amateur radio or AM radio.
- ✎ Using two-way radio mobile and portable units or amateur radio or AM radio near your TV may cause the TV to malfunction.
- ✎ Use caution when you move or swivel the TV if the antenna cable is tightly connected. You could break the antenna jack off the TV.

Connecting to AV Devices (Blu-ray Players, DVD Players, etc.)

Using an HDMI Cable for an HD connection (up to 1080p, HD digital signals)

For the best quality HD picture, we recommend using an HDMI connection.

Use with DVD players, Blu-ray players, HD cable boxes, and HD Set-Top-Box satellite receivers.

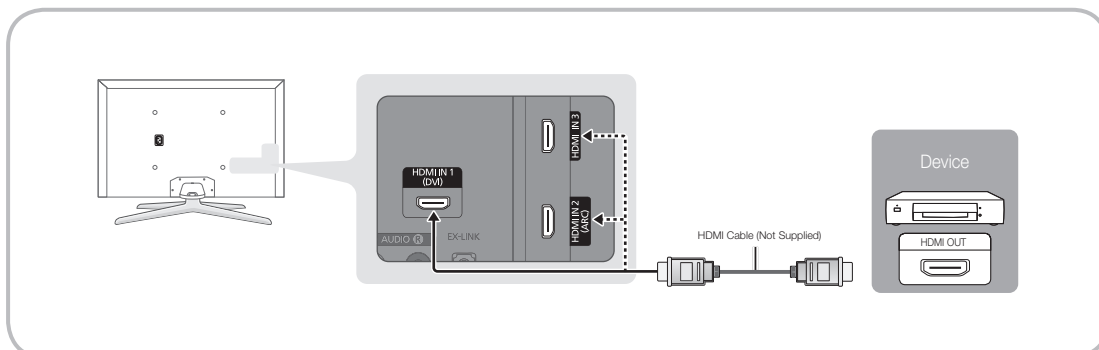

HDMI IN 1 (DVI), HDMI IN 2 (ARC), HDMI IN 3

- For the best picture and audio quality, connect digital devices to the TV using HDMI cables.
- An HDMI cable supports digital video and audio signals, and does not require an audio cable.
 - To connect the TV to a digital device that does not support HDMI output, use an HDMI to DVI cable and audio cables.
- If you connect an external device to the TV that uses an older version of HDMI, the video and audio may not work. If this occurs, ask the manufacturer of the device about the HDMI version and, if it is out of date, request an upgrade.
- Be sure to purchase a certified HDMI cable. Otherwise, the picture may not display or a connection error may occur.
- We recommend using a basic high-speed HDMI cable or an HDMI cable that is Ethernet compatible. Note that this product does not support the Ethernet function via HDMI.
- This product supports the 3D and ARC (Audio Return Channel) functions via an HDMI cable. Note that the ARC function is supported by the **HDMI IN 2 (ARC)** port only.
- The ARC function allows digital audio to output via the **HDMI IN 2 (ARC)** port on the TV. It can be enabled only when the TV is connected with an audio receiver that supports the ARC function.

Using a Component Cable (up to 1080p HD signals) or an Audio/Video Cable (480i analog signals only)

Use with DVD players, Blu-ray players, cable boxes, STB satellite receivers, VCRs.

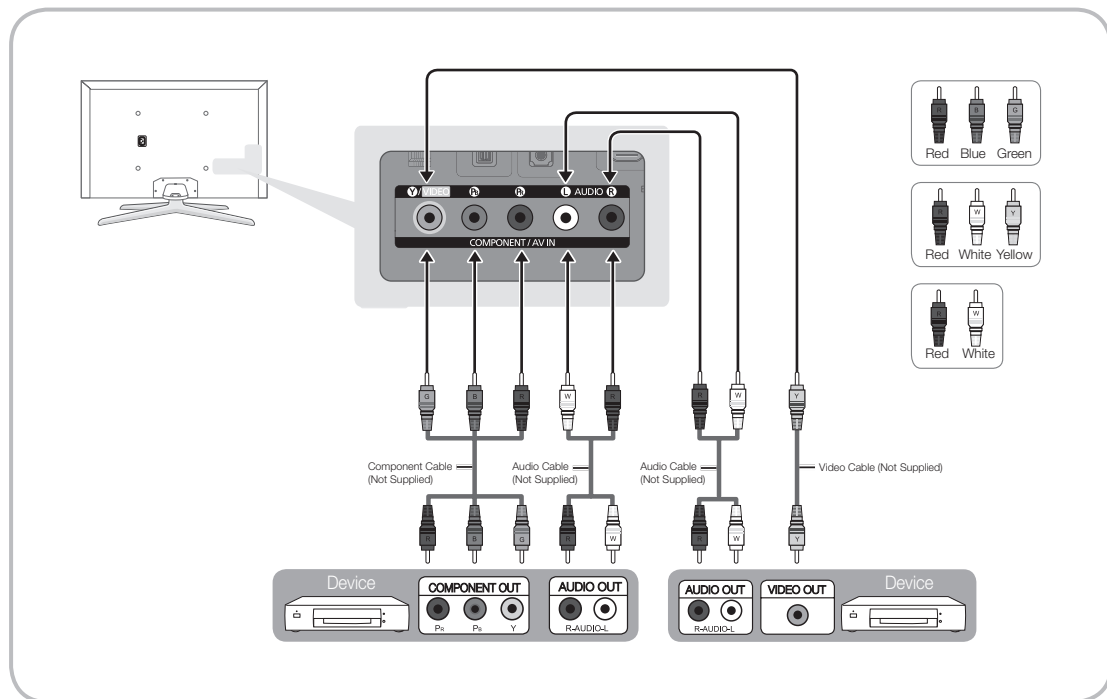

- ✎ For better picture quality, we recommend the Component connection over the A/V connection.
- ✎ When you connect a Video cable to **COMPONENT / AV IN**, the color of the **COMPONENT / AV IN [VIDEO]** jack (green) will not match the video cable (yellow).

Connecting to Audio Devices

Using an Optical (Digital) Cable Connection

Use with Digital Audio Systems, Amplifiers, and Home Theaters.

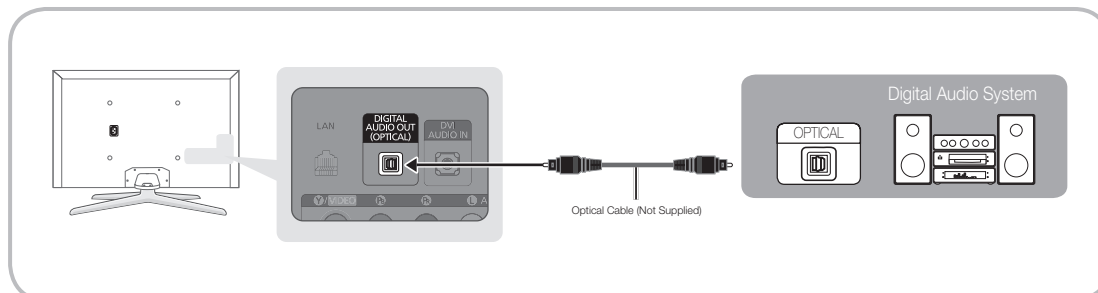

DIGITAL AUDIO OUT (OPTICAL)

- When you connect a Digital Audio System to the **DIGITAL AUDIO OUT (OPTICAL)** jack, decrease the volume of both the TV and the system.
- 5.1 CH (channel) audio is available when you connect the TV to an external device supporting 5.1 CH.
- When the receiver (or home theater) is set to on, you can hear sound output from the TV's optical jack. When the TV is receiving a DTV signal, the TV will send 5.1 CH sound to the home theater receiver. When the source is a digital component such as a DVD player / Blu-ray player / cable box / STB (Set-Top-Box) satellite receiver and you connected it to the TV via HDMI, you will only hear 2 CH audio from the home theater receiver. If you want to hear 5.1 CH audio, connect the digital audio out jack from your DVD / Blu-ray player / cable box / STB satellite receiver directly to an amplifier or home theater.

Connecting to a PC

Using an HDMI cable or an HDMI to DVI cable

- ✎ Your PC may not support an HDMI connection.
- ✎ Use your PC speakers for audio.

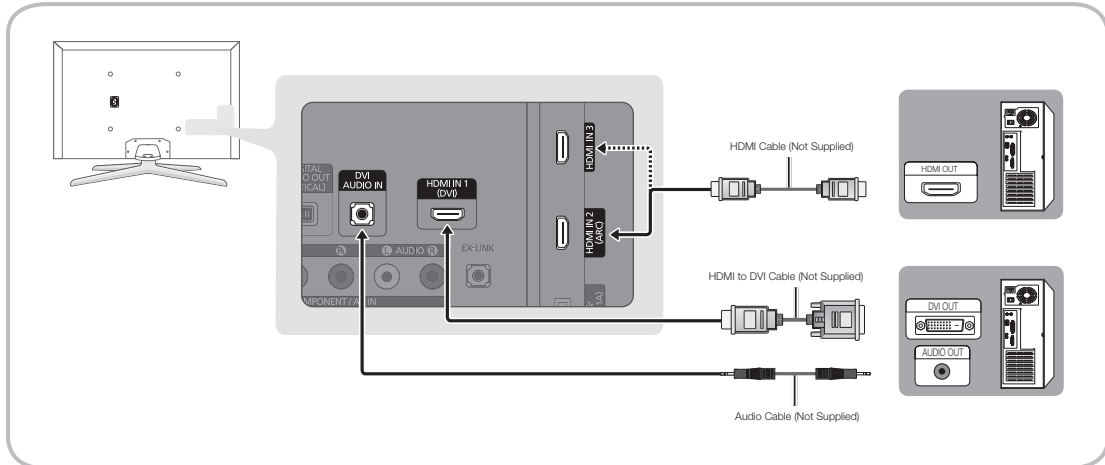

The optimal resolution is 1920 X 1080 @ 60 Hz. See the Display Resolution page for all available resolutions (page 41).

NOTE

- For an HDMI to DVI cable connection, you must use the **HDMI IN 1 (DVI)** jack.
- For PCs with DVI video out jacks, use an HDMI to DVI cable to connect the DVI out on the PC to the **HDMI IN 1 (DVI)** jack on the TV. Use the PC's speakers for audio.
- PC (D-Sub) input is not supported.

The EX-Link Cable Connection



The EX-LINK connection is for service only.

Connecting to a Network

You can set up your TV so that it can access SMART TV applications through your local area network (LAN) using a wired or wireless connection.

After you have “physically” connected your TV to your network, you must configure the network connection to complete the process. You can configure the connection during the Initial Setup process (see page 22) or after the Initial Setup process, through the TV’s menu (see page 30).

Network Connection - Wireless

You can connect your TV to your local area network (LAN) through a standard wireless router or modem.

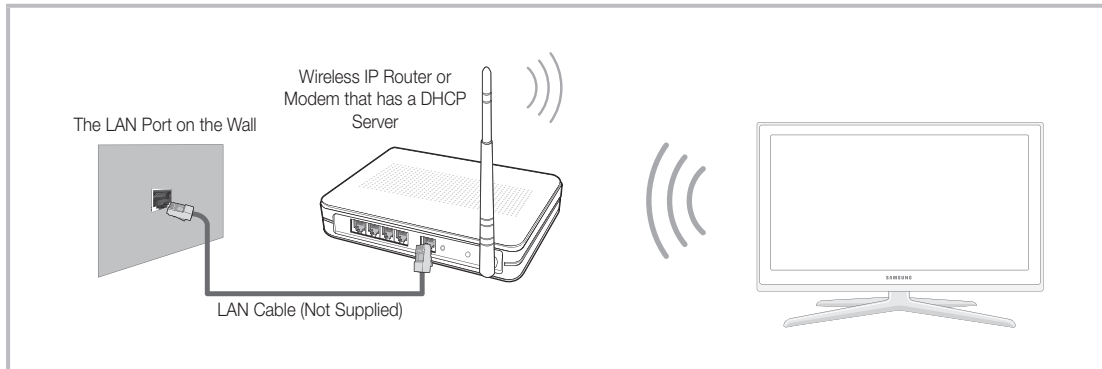

This TV supports the IEEE 802.11a/b/g and n communication protocols. Samsung recommends using IEEE 802.11n. If you play video using IEEE 802.11a, b, or g, the video may not play smoothly.

Most wireless network systems incorporate a security system that requires devices that access the network through an access point or AP (typically a wireless router or modem) to transmit an encrypted security code called an access key.

Your TV is compatible with the following security protocols:

- Authentication Mode: OPEN, SHARED, WPAPSK, WPA2PSK
- Encryption Type: WEP, TKIP, AES

If you select Pure High-throughput (Greenfield) 802.11n mode and the Encryption type is set to WEP or TKIP on your AP or wireless router, Samsung TVs will not support a connection in compliance with new Wi-Fi certification specifications.

Network Connection - Wired

There are three main ways to connect your TV to your network using cable, depending on your network setup. They are illustrated starting below:

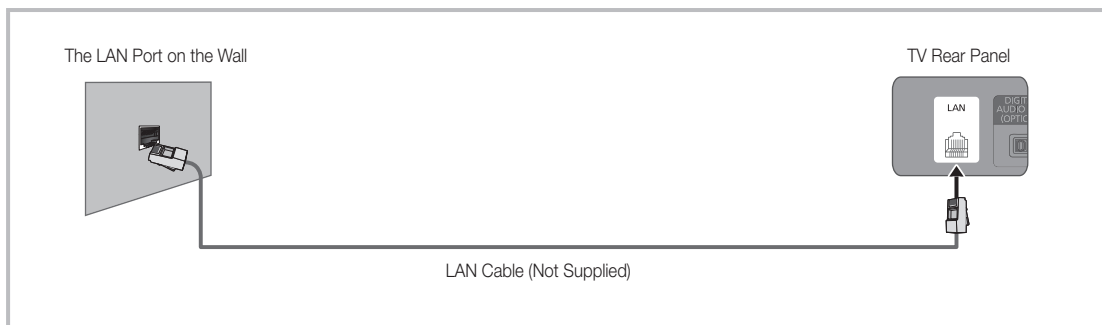
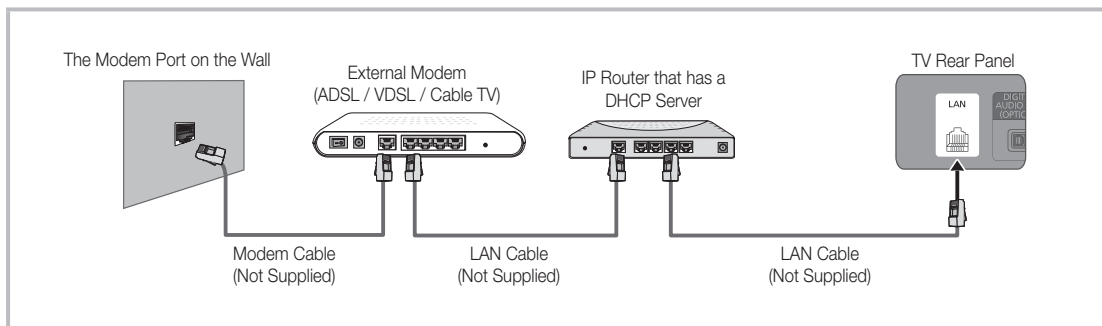
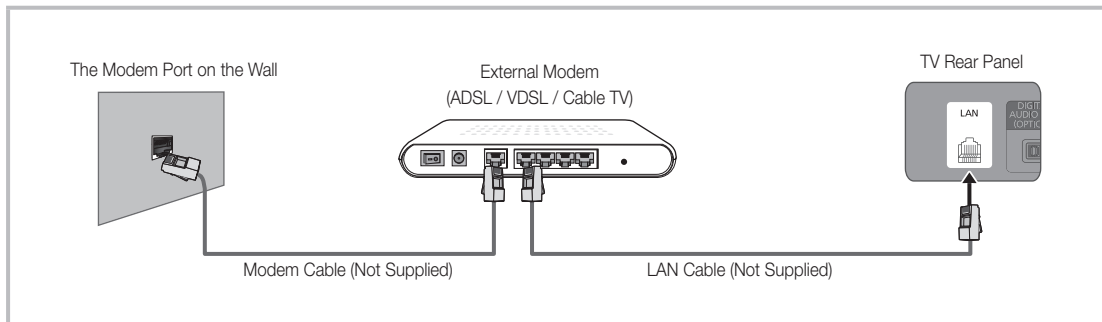

- ✎ The TV does not support network speeds less than or equal to 10Mbps.
- ✎ Use Cat 5 or 6 (STP Type*) cable for the connection. (*Shielded Twisted Pair)

The Remote Control

Installing batteries (Battery size: AAA)

Match the polarity of the batteries to the symbols in the battery compartment.

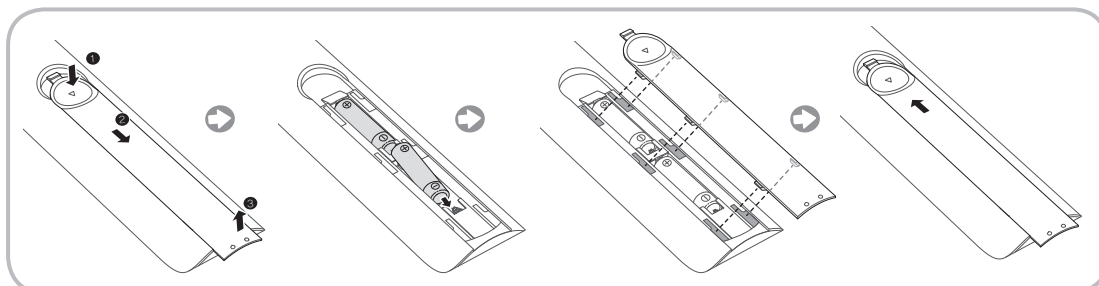

NOTE

- Install the batteries so that the polarity of the batteries (+/-) matches the illustration in the battery compartment.
- Use the remote control within 23 feet of the TV.
- Bright light may affect the performance of the remote control. Avoid using it near fluorescent lights or neon signs.
- The color and shape of the remote may vary depending on the model.



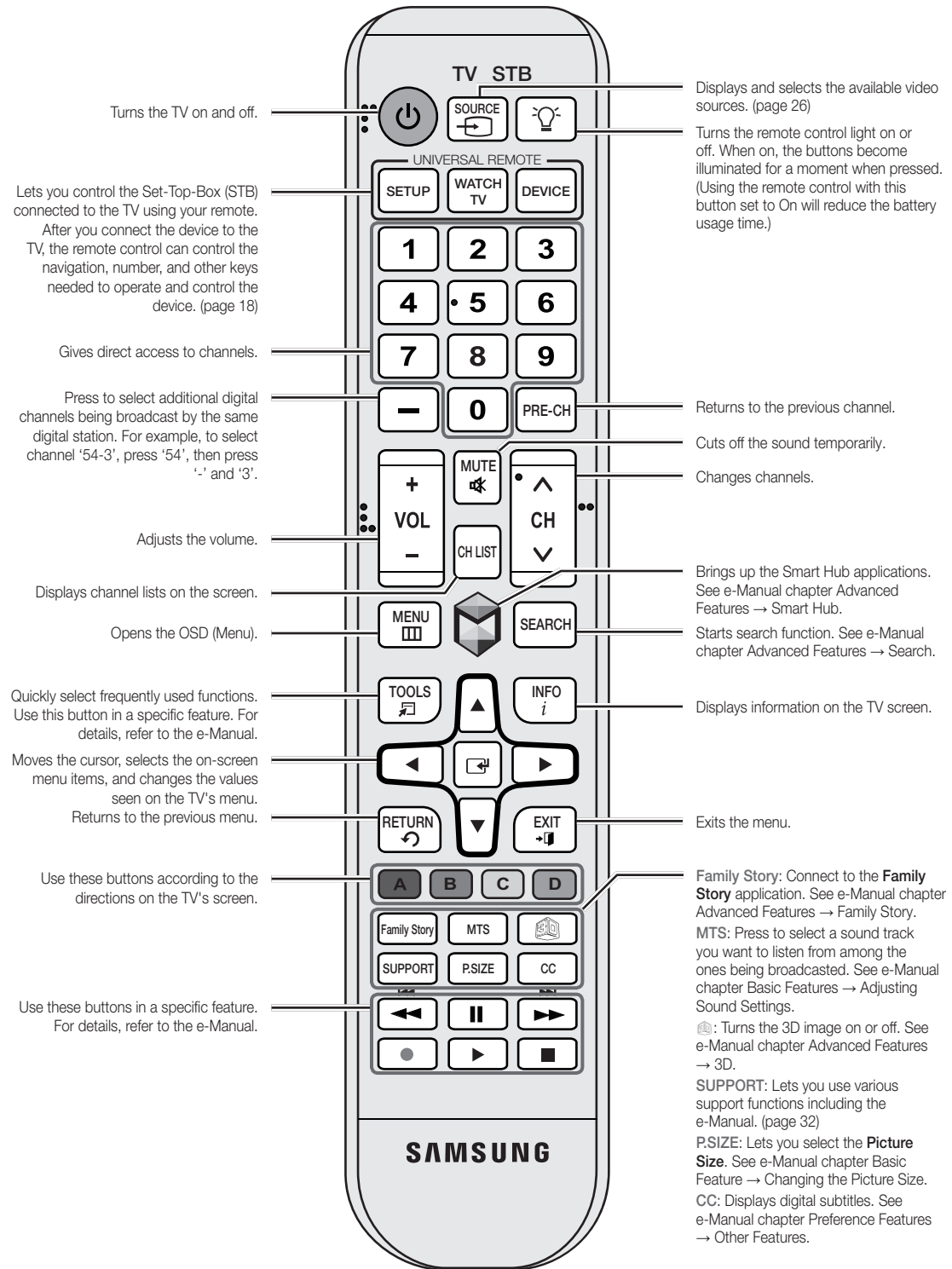

The Remote Control Buttons

Learn where the function buttons are on your remote. Especially note **SOURCE**, **MUTE**, **VOL**, **CH**, **MENU**, **TOOLS**, **INFO**, **CH LIST**, **RETURN**, and **EXIT**.

 This remote control has Braille points on the Power, Channel, and Volume buttons and can be used by visually impaired persons.



Setting up Universal Remote with The Universal Remote Setup Application

-  If your remote controller buttons does not work, please set your remote to TV mode by using the **DEVICE** button.
1. To set up Universal Remote, press the **SETUP** button on your remote.
 2. To identify your remote, press and hold the **SETUP** button for 8 seconds. If you use this function for the first time, the END USER LICENSE AGREEMENT screen appears.
 3. Press the  button to select **I AGREE**. It is required to agree with the terms prior to using Universal Remote.
 4. Select a remote control you have. The remote option menu screen appears.
 5. Select **Set up a device to control**. The **Select a device** screen appears.
 6. Select an external device you want to connect. The **Input Source** screen appears.
 7. Select a port that the external device is connected to the TV. The **Brand** screen appears. If your TV cannot find an external device, please check your external device connection, and then try again by selecting **Refresh**.
 8. Select a brand name of the external device you have. The **Model** screen appears. To search a brand name, select **Search brands**. The QWERTY keypad screen appears. Input a brand name using the QWERTY keypad screen. When done, select **Done**. Wait until the search is completed and then select a brand name in the search result.
 9. Select **SEARCH MODEL**. The QWERTY keypad screen appears. Input a model number in the same way as Step 8, and then select a model number you have in the search result list. If you can't find the model, select **Recommended**. The TV progresses a test using the code set of the brand you selected. If you select **Recommended**, go to Step 11. If you select a model in the search result list, go to Step 13.
 10. The Test screen appears. Press and hold the **SETUP** button for 3 seconds. Numbers appears on the screen.
 11. Enter the following numbers using your remote. The button test screen appears.
 12. Press the  **CH**  button to test your remote. If your external device working, select **YES** to register the device. If you external device is not work, select **NO**. If you select **NO**, the TV changes the code data, and then the Test screen reappears. Try again Steps 10 to 12.

 If all the code data do not work, please check the brand name or search a model name of your external device again.
 13. Your external device has been setup successfully.

Setting up Universal Remote with Universal Remote Code Set

If your remote controller buttons does not work, please set your remote to TV mode by using the **DEVICE** button.

1. To set up Universal Remote, press the **SETUP** button on your remote for 3 seconds. All the LEDs on the top of your remote blink twice simultaneously.
2. Press the **1** button on your remote to select a Set-top box.
3. Press the number button corresponding to the port of device connected.

 Port numbers are as follows:

1	2	3	5	7
HDMI 1/DVI	HDMI 2	HDMI 3	AV	Component

4. Enter Universal Remote Code corresponding to device you have.

 For more detailed information about Universal Remote Code, refer to "Universal Remote Code Set list" on page 20.

Using your remote as a Universal Remote

In Universal Remote mode, you can use your remote to control your TV and STB together, your TV alone, or your STB alone. When you have set your remote to control your TV and STB, certain buttons control the TV only and certain buttons control the STB only.

• Controlling the TV and STB Together

To control your TV and STB together, press the **WATCH TV** button at the top center of your remote. The TV and STB LEDs go on and off. If the TV is on, it automatically changes to the source the STB is connected to.

You can control the TV and Set-Top box using the universal remote. (For example, press the Volume button to adjust the TV volume, press the channel button to change the STB channels, etc.)

 See the illustration to the right. When you are using the remote as a universal remote, the buttons demarcated for TV control the TV only and the buttons demarcated for STB control the set top box only.

 To turn only the TV off, press the **DEVICE** button, change to TV mode, and then press the **⏻** button. To turn only the STB off, press the **DEVICE** button, change to STB mode, and then press the **⏻** button. To turn the TV and the STB off, press the **⏻** button and hold it for two seconds.

• Controlling the TV only.

Press the **DEVICE** button and change to TV mode. The TV LED goes on and off. You can only control the TV using the universal remote.

• Controlling the STB only

Press the **DEVICE** button and change to STB mode. The STB LED goes on and off. You can only control the Set-Top box using the universal remote.

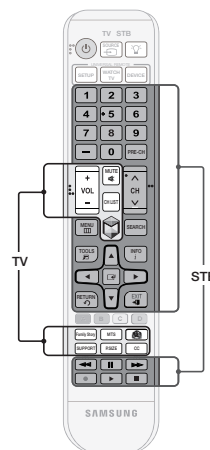

To initializing (reset) the Universal Remote Control

Initializing erases the current code set from the remote control's memory.

1. Press the **SETUP** button for 3 seconds. All the TV and STB LEDs on the top of your remote blink twice simultaneously.
2. Press in sequence: **9, 8, 1**.
3. The TV and STB LEDs on the top of your remote blink once simultaneously, and then the Universal Remote Control initializes.

Universal Remote Code Set list

Setup Codes For Cable Set Top Box

Brand	Code Set
ABC	0008
ADB	2254, 2586
Ajinvision	1271
Amino	1481, 1602, 1822, 2482, 2655
Arris	2187
AT&T	0858
Bell	1998
Bright House	1376, 1877
C & M	2962, 3319
Cable One	1376, 1877
Cablevision	1376, 1877
Charter	1376, 1877, 2187
Cisco	0858, 0877, 1877, 1982, 2345, 2378, 3028
CJ Digital	2693, 2979
CJ HelloVision	3322
Comcast	0476, 1376, 1877, 1982, 2187, 2576
Comtronics	0040
Cox	1376, 1877
Daehan	0778
Daeryung	0008, 0877, 1877
Digeo	2187
Director	0476
Dongkuk	0702
Entone	2302, 3048
Everquest	0040
General Instrument	0476
GoldStar	0040, 0144, 0838
Hana TV	2681, 2959
Hello TV	3322

Brand	Code Set
HelloD	2979
Homecast	2301
Humax	2962
I-Digital	3319
i3 Micro	1602
Insight	1376, 1877
Jerrold	0476
KNC	0008
Knology	1877
KoolConnect	1481
LG	0040, 0144, 0838, 2692
LG U+	2682
Mediacom	1376, 1877
Mega TV	2683
Memorex	0000
Motorola	0476, 0858, 1376, 1982, 1998, 2378
Moxi	2187
MTS	1998
MyLGTV	2682
Myrio	1602, 1822
OllehTV	2683
Pace	0008, 1376, 1877, 1982
Pacific	1410
Panasonic	0000, 1982
Paragon	0000
Pioneer	0144, 0877, 1877
Pulsar	0000
QooK TV	2683
Quasar	0000

Brand	Code Set
RCN	0476, 1376
Rogers	1877
Runco	0000
Samsung	0000, 0040, 0144, 0702, 0840, 1877, 2979, 3319
Sasktel	1998
Scientific Atlanta	0008, 0858, 0877, 1877, 1982, 2345, 3028
Seawoo	0073
Sejin	1602
Shaw	1376
Signal	0040
SKBtv	2681
SL Marx	0040
SMtronics	3319
Stargate	0040
Suddenlink	1376, 1877
SureWest	1481, 1998
Suwon Cable	3319

Brand	Code Set
TaeKwang	0068
Taepyung	1410
Taihan	0778
Teleview	0040
Telus	2345
Thomson	1982
Time Warner	1376, 1877, 2187
Timeless	0040
TiVo	2576
TongKook	0840
Topfield	2981
Toshiba	0000
UBS	0073
Verizon	2378
Videotron	1877
WideOpenWest	1877
Zenith	0000, 0525





Setup Codes For Satellite Set Top Box



Brand	Code Set
Bell ExpressVu	0775
DirecTV	1377, 1442, 1609
Dish Network	0775
Dishpro	0775
Echostar	0775
Expressvu	0775
General Instrument	0869
GOI	0775
HTS	0775
Hughes Network Systems	1377, 1442
Humax	1406, 1407
Jerrold	0869
JVC	0775

Brand	Code Set
LG	0335, 0461
Motorola	0869
Next Level	0869
Olleh-Skylife	3321
Philips	1442
Qook-Skylife	3321
RadioShack	0869
Radix	1255
Samsung	1276, 1377, 1442, 1609
Shaw Direct	0869
SkyLife	0796, 1255, 3321
Star Choice	0869
TiVo	1442
Voom	0869

Configuring the Basic Settings in Initial Setup

When you turn the TV on for the first time, a sequence of screens and on-screen prompts will assist you in configuring the TV's basic settings. Plug the power cord into a wall outlet, and then press the  button to turn on the TV.

-  **Setup** is available only when the input source is set to TV. See "Changing the Input Source" (page 26).
-  To return to the previous step in the **Setup** sequence, select **Previous**.
-  If you are not using a cable box or satellite box, make sure you have connected the TV to an antenna or cable connection before you turn on the TV. See page 9 for instructions.
-  If you want to configure a wired network connection during **Setup**, make sure you've connected a LAN cable to your TV. See pages 15 for instructions. If you want to configure a wireless network connection during **Setup**, make sure your wireless modem or router is on and working.







1	Menu Language: Select a Language.	After you press the  button, the Start screen appears. Select Next to continue. The Menu Language screen appears. Select the menu language you want using your remote, and then select Next . The TV will display on-screen menus using the language you select beginning with the next step in the Setup process.
2	Use Mode: Select the Home Use Mode.	On the Use Mode screen, select the Home Use using your remote, and then select Next . The Network Settings screen appears.  Store Demo is for retail environments only. If you select Store Demo , some functions will not work, and the TV will reset all functions to their factory default every 15 minutes. For more information about Store Demo , go to the end of this section.
3	Network Settings: Configure the network settings  To configure later, select Skip . You can set up the network connection later using the on-screen Network menu.	To configuring your network settings, select Start using your remote, and then go to 3A - Wireless Network or 3B - Wired Network on the next page. If you do not know your network configuration information or want to configure the settings later, or do not have a network, select Skip , and then go to 6 - Auto Program (1) on page 24. To configure network settings later, refer to "Setting up the Wired or Wireless Network" in the e-Manual or see the Network Connection sections in this manual (pages 14 and 30).



3A Wireless Network

1. The TV searches for and then displays all the wireless networks within range. When done, it displays a list of the networks. In the list of networks, move the Highlight to select a network, and then select **Next**. If the selected network requires a Security Key, the Security Key screen appears.
 - ✎ If you have a WPS(PBC) compatible router, select **WPS(PBC)** instead, and then follow the directions on the screen. When done, go to Step 4.
2. Enter your network security key or WPS PIN using your remote.
 - ✎ Enter numbers and letters using your remote.
 - You can enter numbers by pressing the number buttons on the remote.
 - To enter a letter, move the Highlight to the letter, and then select it. You can enter numbers in the same fashion if you choose.
 - ✎ To display capital letters (or redisplay small letters if capital letters are displayed), select **Caps** or **Shift**.
 - ✎ To display symbols and punctuation, select **★**. To redisplay letters, select **★** again.
3. When done, select **Next** if you have entered a security key or **WPS PIN** if you have entered a WPS PIN.
4. The TV checks the wireless connection. If the connection is successful, the **You are connected to the Internet. If you have any problems using online services, please contact your Internet Service Provider.** message appears. Select **Next**, and then go to 4 **Software Upgrade** Step.
 - ✎ If the connection fails, select **Previous**, repeat Step 1 and 2, carefully re-enter your security key or WPS PIN, then repeat Steps 3 and 4. If it fails again, select **Next** on the "Connection Failed" screen, and then go to 6 - **Auto Program** (1) on the next page. Configure your network later through **Network Settings** in the TV's Menu. For more information, refer to "Setting up the Wired or Wireless Network" in the e-Manual or see the Network Connection sections in this manual (pages 14 and 30).

3B Wired Network

The TV checks the network connection, then displays the **You are connected to the Internet. If you have any problems using online services, please contact your Internet Service Provider.** message appears. Select **Next**. The **Software Upgrade** screen appears.

<p>4</p>	<p>Software Upgrade: Update the software to the latest version</p> <p> To update later, select Skip.</p>	<p>When Network Settings is complete, your TV will check for a new software version automatically. If new software is available, the TV downloads and installs the new software. When the download is complete, select Next.</p> <p> If you want to upgrade later, select Skip. For more information, refer to Software Update (Preference Features → Support Menu) in the e-Manual.</p> <p> This may take some time, depending on your network status.</p> <p> You can only upgrade software if your TV has an active network connection.</p> <p> If no new update software is available, a no new updates message appears on the screen. Select OK.</p>
<p>5</p>	<p>Terms of Service Agreement</p>	<p>The Terms of Service Agreement screen appears.</p> <p> The screen can take a few seconds to display.</p> <p>The General Disclaimer screen appears. Select Agree. The Privacy Policy screen appears. Select Agree.</p> <p> To use Smart Hub, you must select Agree for the Terms of Service Agreement.</p>
<p>6</p>	<p>Auto Program (1): Select where your TV signal comes from.</p>	<p>Select the appropriate option for your TV using your remote, and then select Next.</p> <ul style="list-style-type: none"> • I use an aerial cable to connect to TV: Select if you have an antenna or a cable connection without a set-top box. If you select this option, go to 7 - Auto Program (2) Step. • I use a set-top box.: Select if you have a satellite or cable set-top box. You do not need to run Auto Program. If you select this option, go to 9 - Clock on the next page.
<p>7</p>	<p>Auto Program (2): Select the search options.</p>	<ol style="list-style-type: none"> 1. Select Air or Cable using your remote. A check appears on your selection. When done, select Next. You can check both if you have both connected. 2. If you selected Air, go to 8 - Auto Program (3). 3. If you selected Cable, you'll go to the cable system screen. Select Digital Cable System. The option window appears. Select the correct cable signal format; STD, HRC, or IRC. Most cable systems use STD (Standard). Repeat the same process with Analog Cable System. 4. When done, select Next.

8	Auto Program (3): Channel memorization	<p>Channel memorization starts. Channel memorization can take up to 45 minutes, depending on your cable system.</p> <p>For more information, refer to Auto Program (Channel Menu → Memorizing Channels) in the e-Manual.</p> <p> Select Stop at any time to halt the memorization process.</p>
9	Clock: Set the Clock	<p>Select Auto or Manual, and then select Next.</p> <p> If you selected I have a set-top box. in 6 - Auto Program (1), you can only set the current time and date manually, using your remote.</p> <p>Auto</p> <p>If you selected Auto, the TV will automatically download the correct time from a digital channel. The Time Zone screen will appear. Select your Time Zone, and then select Next. The DST (Daylight Savings Time) screen will appear. The DST function sets the time ahead one hour to adjust the clock for Daylight Savings Time. Select On if you want to turn the DST adjustment on. Select Off to turn off the DST adjustment. You can also turn the DST function on through the TV's on screen menu (Menu → System → Time → Clock → DST).</p> <p>Manual</p> <p>If you selected Manual, you'll go to the Clock screen. Select Date or Time. You can set the current date and time using your remote. When done setting the Date and Time, select Next.</p>
10	Setup Complete	<p>Review the Setup data, and then select Close to finish.</p> <p> The completed settings are displayed.</p>

If You Want to Rerun Setup...

Menu → **System** → **Setup**

If You Want to Turn the Store Demo Mode On or Off.

To set or unset **Store Demo** mode outside of **Setup**, press and release the Controller when the power is on. The Function menu screen appears. Push the Controller to the left (to **MENU** (III)) and hold for more than 5 seconds. The **Store Demo** mode is set. To cancel **Store Demo**, bring up the Function menu using the Controller, push the Controller to the right (to **Source** (I)) and hold for more than 5 seconds. See page 28 for information about the Controller.

Changing the Input Source

Source



 → **Source**

When you are watching TV and you want to watch a movie on your DVD player or Blu-ray player or switch to your cable box or STB satellite receiver, you need to change the Source.



■ TV / HDMI1/DVI / HDMI2 / HDMI3 / AV / Component



1. Press the  button on your remote. The **Smart Hub** screen appears.
2. Select **Source**. The **Source** screen appears.
3. Select a desired external input source.

-  Alternatively, you can access the **Source** screen by pressing the **SOURCE**  button on your remote.
-  You can only choose external devices that are connected to the TV. In the displayed **Source** list, connected inputs are highlighted.

How to Use Edit Name

Edit Name lets you associate a device name to an input source. To access **Edit Name**, press the **TOOLS**  button on your remote when the **Source** list is displayed. The following selections appear under **Edit Name**:

■ **VCR / DVD / Cable STB / Satellite STB / PVR STB / AV Receiver / Game / Camcorder / PC / DVI PC / DVI Devices / TV / IPTV / Blu-ray / HD DVD / DMA**: Select an input jack, and then select the name of the device connected to that jack from the list that appears. For example, if you have your Blu-ray player attached to **HDMI IN 2**, select **Blu-ray** for that input.

-  If you connect a PC to the **HDMI IN 1 (DVI)** port with an HDMI cable, assign **PC** to **HDMI1/DVI** in **Edit Name**.
-  If you connect a PC to the **HDMI IN 1 (DVI)** port with an HDMI to DVI cable, assign **DVI PC** to **HDMI1/DVI** in **Edit Name**.
-  If you connect an AV device to the **HDMI IN 1 (DVI)** port with an HDMI to DVI cable, assign **DVI Devices** to **HDMI1/DVI** in **Edit Name**.

Information

You can see detailed information about the selected external device.

Refresh

If the external devices are not displayed in the **Source** list, open the **Tools** menu, select **Refresh**, and then search for the connected devices.

-  Alternatively, you can refresh the **Source** list by pressing the **A** button on your remote.

How to Navigate Menu

Your TV's Main and Tools menu contains functions that let you control the TV's features. For example, in the Main menu you can change the size and configuration of the picture, its brightness, its contrast and so on. There are also functions that let you control the TV's sound, channel configuration, energy use, and a host of other features. To access the main, on-screen menu, press the **MENU** button on your remote. To access Tools menus, press the **TOOLS** button. Tools menus are available when the **TOOLS** menu icon is displayed on the bottom right of the screen.

The illustration below displays the buttons on the remote you use to navigate the menus and select and adjust different functions.

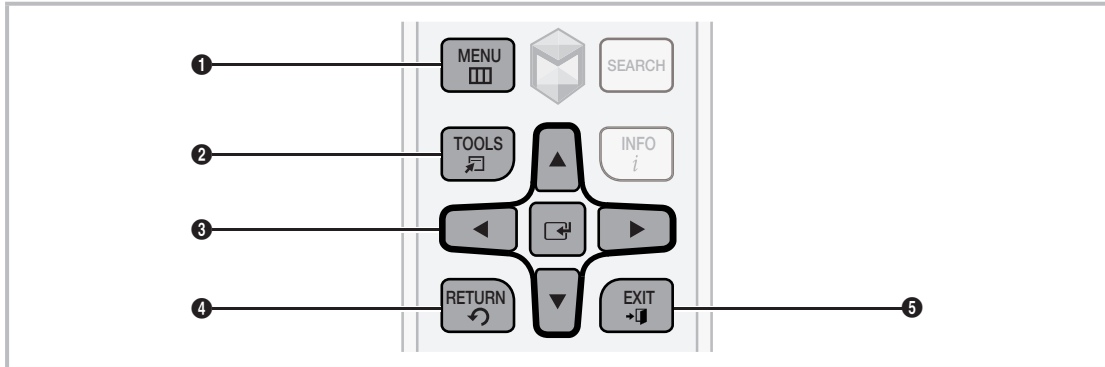

- ❶ **MENU** button: Displays the main on-screen menu.
- ❷ **TOOLS** button: Displays the Tools menus when available.
- ❸ **↔** and Direction buttons: Use the Direction buttons to move the cursor and highlight an item. Use the Enter button to select an item or confirm the setting.
- ❹ **RETURN** button: Returns to the previous menu.
- ❺ **EXIT** button: Exits the on-screen menu.

How to Operate the Main Menu (OSD - On Screen Display) Using the Remote

The access steps may differ depending on the menu option you select.

1	MENU	The main menu options appear on the screen: Picture, Sound, Channel, Network, System, Support.
2	▲ / ▼	Select a main menu option on the left side of the screen with the ▲ or ▼ button.
3	↵	Press ↵ to access the sub-menus.
4	▲ / ▼	Select the desired submenu with the ▲ or ▼ button.
5	▲ / ▼ / ◀ / ▶	Adjust the value of an item with the ◀, ▶, ▲, or ▼ button. The adjustment in the OSD may differ depending on the selected menu.
6	↵	Press ↵ to confirm the selection.
7	EXIT	Press EXIT .

Using the TV's Controller (Panel Key)

The TV's Controller, a small joy stick like button on the bottom left side of the TV, lets you control the TV without the remote control.

The product color and shape may vary depending on the model.

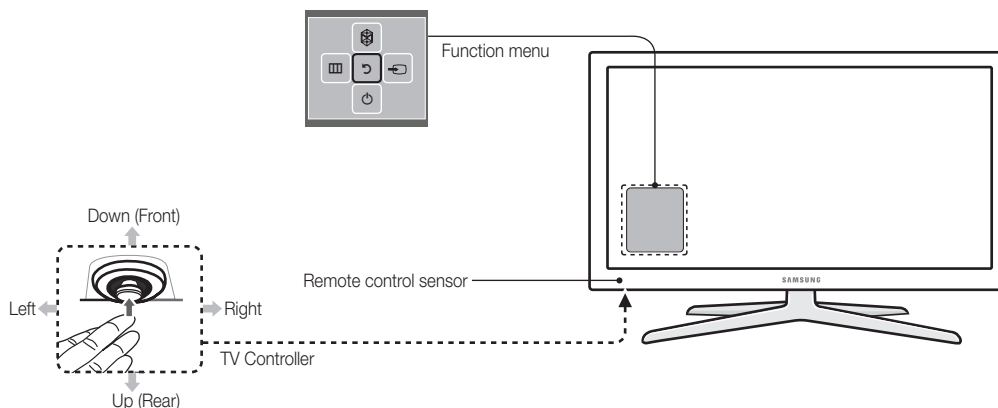

Follow these instructions facing the front of your TV.

When selecting the function by moving the controller to the up/down/left/right directions, be sure not to press the controller. If you press it first, you cannot operate it to move the up/down/left/right directions.

Power on	Turn the TV on by pressing the Controller when the TV is in standby mode.
Adjusting the volume	Adjust the volume by moving the Controller from side to side when the power is on.
Selecting a channel	Select a channel by moving the Controller backwards and forwards when the power is on.
Using the Function menu	To view and use the Function menu, press and release the Controller when the power is on. To close the Function menu, press and release the Controller again.
Selecting the SMART HUB (Ⓜ)	With the Function menu visible, select SMART HUB (Ⓜ) by moving the Controller backwards. The SMART HUB main screen appears. Select an application by moving the Controller, and then pressing the Controller.
Selecting the MENU (☰)	With the Function menu visible, select the MENU (☰) by moving the Controller to the left. The OSD (On Screen Display) Menu appears. Select an option by moving the Controller to the right. Move the Controller to the right or left, or backwards and forwards to make additional selections. To change a parameter, select it, and then press the Controller.
Selecting a Source (⇄)	With the Function menu visible, open the Source (⇄) list by moving the Controller to the right. The Source list screen appears. To select a source, move the Controller back and forth. When the source you want is highlighted, press the Controller.
Power Off (⏻)	With the Function menu visible, select Power Off (⏻) by moving the Controller forwards, and then press the Controller.

To close the **Menu**, **Smart Hub**, or **Source**, press the Controller for more than 1 second.

Standby mode

Your TV enters Standby mode when you turn it off and continues to consume a small amount of electric power. To be safe and to decrease power consumption, do not leave your TV in standby mode for long periods of time (when you are away on vacation, for example). It is best to unplug the power cord.

Using Smart Hub

Smart Hub provides easy, on-screen access to five functions that let you manage and access channels, set favorite channels, access photos, videos, or music on USB devices, cameras, and PCs, select video sources, and set the TV to turn on automatically when a show you want to watch is on. The five functions are listed below:

- **Channel:** Lets you manage channels, select favorite channels, add channels to and delete channels from the **Added Ch.** list (the channels that appear when you press the **▼ CH ▲** button.)
- **Web Browser:** Lets you browse the Internet.
- **Schedule Manager:** Lets you schedule shows and channels for viewing.
- **Source:** Lets you select a connected external video source to view.
- **AllShare Play:** Lets you access, view, or play photos, videos, or music located on USB devices, digital cameras, cell phones, and PCs. PCs and cell phones can be accessed wirelessly, through your wireless network.

Smart Hub also provides an easy-to-use gateway to a host of on-line media and entertainment including apps from the Samsung Apps store, streaming videos and movies, kids sites, and more.

 To access **Smart Hub**, press the  button on your remote.

 For more information about **Smart Hub**, see the e-Manual.

Configuring Network Connections

After you have run the initial setup, you can configure or reconfigure the network connections through the TV's menu.

Configuring a Wireless Network Connection

The instructions below are for networks that use the Dynamic Host Configuration Protocol (DHCP) to configure network connections automatically. Most wireless networks use DHCP. If you have a Static IP network, see the e-Manual for configuration instructions.



To configure the network connection for a network that uses DHCP, follow these steps:

1. Connect your TV to your network as shown in the illustration on page 14.
2. Turn on your TV, and then go to the **Network Settings** screen. (**Menu** → **Network** → **Network Settings**)
3. Select **Start**. The Network function searches for available wireless networks. When done, it displays a list of the available networks.
4. In the list of networks, move the highlight to select a network, and then select **Next**.
 - ✎ If you have a WPS(PBC) compatible router, select **WPS(PBC)** instead, and then follow the directions on the screen.
5. Enter your network security key or WPS PIN using your remote.
 - ✎ Enter numbers and letters using your remote.
 - Enter numbers by pressing the number buttons on your remote.
 - To enter a letter, move the Highlight to the letter, and then select it. You can enter numbers in the same fashion if you choose.
 - ✎ To display capital letters (or redisplay small letters if capital letters are displayed), select **Caps** or **Shift**.
 - ✎ To display symbols and punctuation, select **★**. To redisplay letters, select **★** again.
6. When done, select **Next** if you have entered a security key or **WPS PIN** if you have entered a WPS PIN.
7. The TV checks the wireless connection. If the connection is successful, the "**You are connected to the Internet. If you have any problems using online services, please contact your Internet Service Provider.**" message appears. Select **Next** using your remote.
 - ✎ For more detailed information, see "Setting up the Wireless Network" in the e-Manual.
 - ✎ If you want to configure the connection manually, select **IP Settings** on the Network Connection screen. Set **IP Mode** to **Manual**, and then enter the **IP Address**, **Subnet Mask**, **Gateway**, and **DNS Server** manually.

Configuring a Wired Network Connection

Most home networks use the Dynamic Host Configuration Protocol (DHCP) to configure network connections. Home networks that support DHCP automatically provide the IP address, subnet mask, gateway, and DNS values your TV needs to access the Internet so you don't have to enter them manually. If you have a Static IP network, see your user's manual for configuration instructions.

To configure the network connection for a wired network that uses DHCP, follow these steps:

1. Connect your TV to your network as shown in one of the illustrations on page 15.
 2. Turn on your TV, and then go to the **Network Settings** screen. (**Menu** → **Network** → **Network Settings**)
 3. Select **Start**.
 4. The Network Connection screen appears, and verifies the network connection. When the connection has been verified, the **"You are connected to the Internet. If you have any problems using online services, please contact your Internet Service Provider."** message appears. Network set up is completed.
-  If your TV cannot acquire network the connection values automatically or if you want to set the connection manually, select **IP Settings** on the network connection screen. Set **IP Mode** to **Manual**, and then enter the **IP Address**, **Subnet Mask**, **Gateway**, and **DNS Server** manually.
-  For more detailed information, refer to "Setting up the Wired Network" in the e-Manual.

How to view the e-Manual



You can find instructions for your TV's features in the e-Manual. To open the e-Manual, press the **SUPPORT** button on your remote.

You can also access it through the menu:

Menu → Support → e-Manual

Access the e-Manual

To use the e-Manual, follow these steps:

1. When you need to help, press the **SUPPORT** button on your remote. The **Support** screen appears.
2. Select **e-Manual** using your remote. The **e-Manual** screen appears.
3. Select a desired category.
4. Select a desired topic. The e-Manual displays the page you want to see.

Blue words in e-Manual signify menu options or selections on TV screen.

Green icons in the e-Manual signify a button on your remote.

Arrow steps (e.g. **Menu → Support → e-Manual**) in the e-Manual signify the sequence of steps required to access an option or activate a function.

How to toggle between an e-Manual topic and the corresponding OSD menu(s).

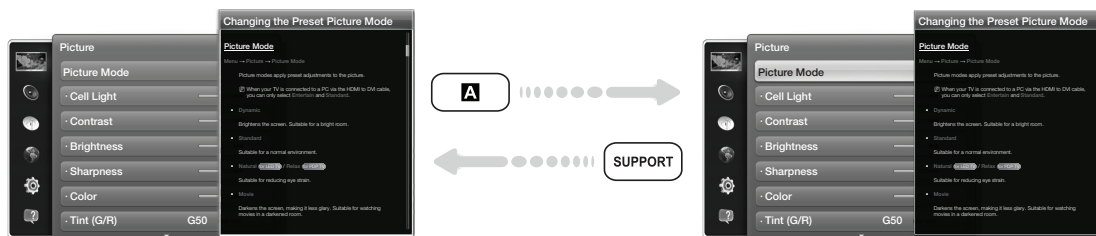

This function is not enabled in some menus.

You can't use the **Try Now** function if the menu is not available.

1. To go to the topic's corresponding menu option, press the **A** button on your remote.
2. To return to the e-Manual screen, press the **SUPPORT** button on your remote.

Using the colored and function buttons with the e-Manual

- **Scroll bar:** Scroll the e-Manual screen up or down.
- **◀ / ▶:** Moves to the previous or next chapter.
- **▲ Try Now:** Move to the OSD menu that corresponds to the topic. To return to the e-Manual screen, press the **SUPPORT** button on your remote.
- **■ Home:** Moves to the e-Manual home screen.
- **■ Position:** Each time you select **■**, you change the position of the e-Manual screen.
- **■ Index:** Displays the Index screen.
- **↶ Return:** Return to the previous screen.

How to search for a topic on the index page

1. Select **■** using your remote. The Index screen appears.
2. To search for a topic, select a letter. The Index displays a list of topics and keywords that begin with the letter you selected.
3. Select a topic or keyword you want.
4. The e-Manual page with the topic appears.
 - ✎ To close the **Index** screen, press the **RETURN** **↶** button.

To Change the screen position of the e-Manual

If the e-Manual screen is not invisible well because the OSD Menus screen, you can change the e-Manual screen's position.

1. Move the Highlight to the e-Manual screen by pressing the **SUPPORT** button on your remote.
2. Press the **■** button on your remote. Each time you select **■**, the position of the e-Manual will change.

Troubleshooting

If the TV seems to have a problem, first review this list of possible problems and solution. Also review the Troubleshooting Section in the e-Manual. If none of the troubleshooting tips apply, visit www.samsung.com/support or call Samsung Customer Service at 1-800-SAMSUNG (1-800-726-7864).

Issues	Solutions and Explanations
Flickering and Dimming	<p>If your Samsung Television is flickering or dimming sporadically, you may need to disable some of its energy efficient features such as the Eco Sensor or the Energy Saving feature. Follow the steps below with your remote to turn these features off or on.</p> <ul style="list-style-type: none"> • Energy Saving: User Menu → System → Eco Solution → Energy Saving • Eco Sensor: User Menu → System → Eco Solution → Eco Sensor
Component Connections / Screen Color	<p>If you find that the color on your Samsung television's screen is not correct or black and white, first run a Self Diagnosis on the TV to make sure there are no device issues.</p> <ul style="list-style-type: none"> • Self Diagnosis: User Menu → Support → Self Diagnosis → Picture Test <p>If the problem does not appear in the Picture test, make sure:</p> <ul style="list-style-type: none"> • Your connections are all consistent. For example, if you've used the AV In jack on your TV, make sure you have used the AV Out jack on your video source. • You have connected your devices to the correct jacks. For example, if you use the Component jacks, labeled Pb, Pr, and Y, to connect your TV and video source, make sure you have connected the blue Pb jack on the video source to the blue Pb jack on the TV, and the yellow Y jack on the source to the yellow Y jack on the TV.
Screen Brightness	<p>If you find that the colors on your Samsung TV are correct but just a little too dark or bright, try adjusting the following settings in the Picture menu option of the Main menu:</p> <ul style="list-style-type: none"> • Cell Light, Contrast, Brightness, Sharpness, Color, Tint (G/R) and so on.

Issues	Solutions and Explanations
Unwanted Powering Off	<p>If your Samsung TV appears to turn off by itself, there may be an issue with either your Timer settings or your Eco friendly No Signal Power Off feature.</p> <p>First make sure Sleep Timer is not accidentally set. The Sleep Timer turns off the TV automatically after a certain period of time has passed.</p> <ul style="list-style-type: none"> • Sleep Timer: User Menu → System → Time → Sleep Timer <p>If the Sleep Timer is not activated, you may have engaged the No Signal Power Off or Auto Power Off feature.</p> <ul style="list-style-type: none"> • No Signal Power Off : User Menu → System → Eco Solution → No Signal Power Off • Auto Power Off: User Menu → System → Eco Solution → Auto Power Off
Trouble Powering On	<p>Before you turn the TV on, find the red light on the right or left bottom of your TV. Press the Power on button on the TV or remote. The light should blink about 5 times before the TV turns on.</p> <p>If you find that you are having trouble powering on your Samsung television, there are a number of things to check before making a call to the service department.</p> <ul style="list-style-type: none"> • If you happen to be using the TV as a monitor and the stand-by light only blinks for a few seconds when you press the power button, your PC is in sleep mode. To take your PC out of sleep mode, press a key on your keyboard or move the mouse. Then try turning your TV on. <p>If you're sure your power cord, remote control, and PC are functioning properly, you may be having a cable issue. If you have a cable or satellite box, your TV may appear to be off because the cable or satellite box is not outputting a signal. To test the signal output of your cable or satellite box, press the guide or info button on the cable or satellite box remote control. If the screen displays the guide or info data, the problem is caused by the box.</p>
Stand Assembly	<p>If you have any trouble assembling the stand, visit www.samsung.com/spsn and watch "2012 Stand Assembly" on the "Top 7 TV Troubleshooting Tips".</p>
Cannot Find a Channel	<p>Re-run Setup (Go to User Menu → System → Setup) or run Auto Program. (Go to User Menu → Channel → Auto Program).</p>

 For detailed troubleshooting information, watch the troubleshooting videos at www.samsung.com/spsn.

Issues	Solutions and Explanations
The TV won't turn on.	<ul style="list-style-type: none"> • Make sure the AC power cord is securely plugged in to the wall outlet and the TV. • Make sure the wall outlet is working. • Try pressing the  button on the TV to make sure the problem is not the remote. If the TV turns on, refer to "Remote control does not work" below.
There is no picture/video.	<ul style="list-style-type: none"> • Check the cable connections. Remove and reconnect all cables connected to the TV and external devices. • Set the video outputs of your external devices (Cable/Sat Box, DVD, Blu-ray etc) to match the TV's input connections. For example, if an external device's output is HDMI, it should be connected to an HDMI input on the TV. • Make sure your connected devices are powered on. • Be sure to select the correct input source • Reboot the connected device by unplugging it, and then reconnecting the device's power cable.
The remote control does not work.	<ul style="list-style-type: none"> • Replace the remote control batteries. Make sure the batteries are installed with their poles (+/-) in the correct direction. • Clean the sensor's transmission window on the remote. • Try pointing the remote directly at the TV from 5~6 feet away.
The cable/set top box remote control doesn't turn the TV on or off, or adjust the volume.	<ul style="list-style-type: none"> • Program the Cable/Set remote control to operate the TV. Refer to the Cable/Set-Top-Box user manual for the SAMSUNG TV code.

 Some functions and pictures shown in this manual are available on specific models only.

 To keep your TV in optimum condition, upgrade to the latest firmware on the Samsung web site by USB (samsung.com → Support → Downloads).

Licenses



Storage and Maintenance

- ✎ If a sticker was attached to the TV screen, some debris can remain after you remove the sticker. Please clean the debris off before watching TV.
- ✎ The exterior and screen of the product can get scratched during cleaning. Be sure to wipe the exterior and screen carefully using the cloth provided or a soft cloth to prevent scratches.

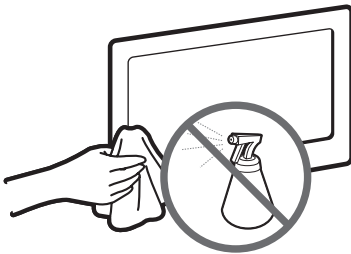

Do not spray water directly onto the product. Any liquid that goes into the product may cause a failure, fire, or electric shock.

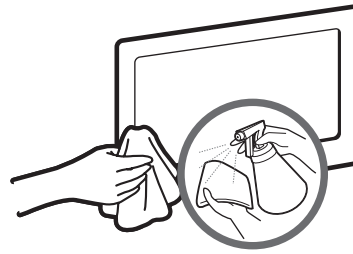

Clean the product with a soft cloth dampened with a small amount of water. Do not use a flammable liquid (e.g. benzene, thinners) or a cleaning agent.

Securing the TV to the Wall

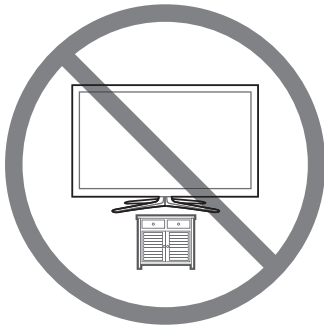

Caution: Pulling, pushing, or climbing on the TV may cause the TV to fall. In particular, ensure your children do not hang over or destabilize the TV. Doing so may cause the TV to tip over, causing serious injuries or death. Follow all safety precautions provided in the Safety Flyer included with your TV. For added stability and safety, you can purchase and install the anti-fall device as described below.

The TV-Holder Kit (Sold Separately):

The parts below are included in the TV Holder kit. In addition, you need to provide a wood screw, screw and molly, or other screw appropriate for the wall or cabinet you intend to secure the TV-Holder string to. We recommend a size M4xL20 wood screw.



TV-Holder (BN96-15753A)



Screw (M8 X L19)

Installing the TV-Holder

1. Remove the screw attached to the back of your TV, and then connect the TV-Holder to the TV with the screw included in the TV-Holder Kit that is designated for your TV.

 Make sure to use only the appropriate supplied screw. If you use a different screw, you can damage your TV.

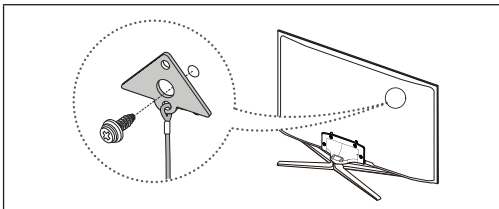

2. Firmly fasten the screw you provided (size M4xL20 or similar) to the wall or cabinet where the TV is to be installed.

 If you fasten the screw to the wall, we recommend you drive the screw into a stud. If that is not possible, use a molly to anchor the screw.

3. Tie the TV-Holder cord to the screw fastened to the wall or cabinet so that the TV is fixed. See the illustrations below.

- 🔗 Install the TV close to the wall so that it does not fall.
- 🔗 When attaching the TV-Holder cord to the wall, tie the cord level with the ground or slanted downwards for safety purposes.
- 🔗 Check the cord occasionally to make sure it is secure.
- 🔗 Before moving the TV, separate the connected cord first.

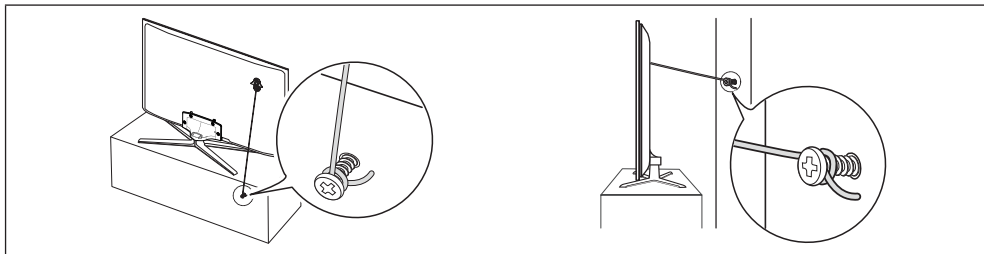





4. Verify all connections are properly secured. Periodically check the connections for any sign of fatigue or failure. If you have any doubt about the security of your connections, contact a professional installer.

To purchase the TV-Holder Kit, contact Samsung Customer Care

- In the United States: 1-800-SAMSUNG (1-800-726-7864)
- In Canada: 1-800-SAMSUNG (1-800-726-7864)

Specifications

Display Resolution	1920 x 1080	
Environmental Considerations		
Operating Temperature	50°F to 104°F (10°C to 40°C)	
Operating Humidity	10% to 80%, non-condensing	
Storage Temperature	-4°F to 113°F (-20°C to 45°C)	
Storage Humidity	5% to 95%, non-condensing	
Stand Swivel (Left / Right)	-20° ~ 20°	
Model Name	PN51E6500	PN60E6500
Screen Size (Diagonal)	51" Class (50.7" measured diagonally)	60" Class (60.0" measured diagonally)
Sound (Output)	10 W X 2	
Dimensions (W x H x D)		
Body	46.9 x 28.1 x 2.2inches (1193.0 x 714.0 x 56.0 mm)	54.8 x 32.7 x 2.2 inches (1394.3 x 832.6 x 56.0 mm)
With stand	46.9 x 31.7 x 12.1 inches (1193.0 x 806.3 x 309.3 mm)	54.8 x 36.3 x 13.8 inches (1394.3 x 922.8 x 351.7 mm)
Weight		
Without Stand	45.6 lbs (20.7 kg)	65.0 lbs (29.5 kg)
With Stand	50.7 lbs (23.0 kg)	72.0 lbs (32.7 kg)

-  Design and specifications are subject to change without prior notice.
-  The actual appearance of the TV may differ from the images in this manual, depending on the model.
-  This device is a Class B digital apparatus.
-  For information about the power supply, and more about power consumption, refer to the label attached to the product.
-  Typical power consumption is measured according to Energy Star Program requirements for Televisions.

Dispose unwanted electronics through an approved recycler.

To find the nearest recycling location, go to our website:

www.samsung.com/recyclingdirect or call, (877) 278 - 0799

Display Resolution

If you have attached the TV to your PC, you can select one of the standard resolutions listed in the Resolution column. The TV will automatically adjust to the resolution you choose.

Mode	Resolution	Horizontal Frequency (KHz)	Vertical Frequency (Hz)	Pixel Clock Frequency (MHz)	Sync Polarity (H / V)
IBM	640 x 350	31.469	70.086	25.175	+/-
	720 x 400	31.469	70.087	28.322	-/+
MAC	640 x 480	35.000	66.667	30.240	-/-
	832 x 624	49.726	74.551	57.284	-/-
	1152 x 870	68.681	75.062	100.000	-/-
VESA DMT	640 x 480	31.469	59.940	25.175	-/-
	640 x 480	37.861	72.809	31.500	-/-
	640 x 480	37.500	75.000	31.500	-/-
	800 x 600	37.879	60.317	40.000	+/+
	800 x 600	48.077	72.188	50.000	+/+
	800 x 600	46.875	75.000	49.500	+/+
	1024 x 768	48.363	60.004	65.000	-/-
	1024 x 768	56.476	70.069	75.000	-/-
	1024 x 768	60.023	75.029	78.750	+/+
	1152 x 864	67.500	75.000	108.000	+/+
	1280 x 720	45.000	60.000	74.250	+/+
	1280 x 800	49.702	59.810	83.500	-/+
	1280 x 1024	63.981	60.020	108.000	+/+
	1280 x 1024	79.976	75.025	135.000	+/+
	1366 x 768	47.712	59.790	85.500	+/+
	1440 x 900	55.935	59.887	106.500	-/+
	1600 x 900RB	60.000	60.000	108.000	+/+
1680 x 1050	65.290	59.954	146.250	-/+	
1920 x 1080	67.500	60.000	148.500	+/+	

NOTE

- The interlaced mode is not supported.
- The set might operate abnormally if you select a non-standard video format.
- Separate and Composite modes are supported. SOG (Sync On Green) is not supported.

Video Codec

File Extension	Container	Video Codec	Resolution	Frame rate (fps)	Bit rate (Mbps)	Audio Codec
*.avi	AVI MKV ASF MP4 3GP VRO VOB PS TS WebM	DIVX 3.11/4.x/5.x/6.1	1920 x 1080	6 – 30	30	AC3 LPCM ADMPCM(IMA, MS) AAC HE-AAC WMA DD+ MPEG(MP3) DTS Core Voris
*.mkv		MPEG4 SP/ASP				
*.asf		H.264 BP/MP/HP				
*.wmv		Motion JPEG	640 x 480		8	
*.mp4		Window Media Video v9	1920 x 1080		30	
*.3gp		MPEG2				
*.vro		MPEG1				
*.mpg		VP8				
*.mjpeg		VP6				
*.ts						
*.tp						
*.trp						
*.m2ts						
*.mts						
*.webm						
*.divx						

Other Restriction

- 📎 Video content will not play, or not play correctly, if there is an error in the content or the container.
- 📎 Sound or video may not work if the contents have a standard bit rate/frame rate above the compatible Frame/sec listed in the table above.
- 📎 If the Index Table is in error, the Seek (Jump) function is not supported.
- 📎 When you play video over a network connection, the video may not be played smoothly.
- 📎 The menu may take longer to appear if the video's bit rate exceeds 10Mbps.
- 📎 Some USB/digital camera devices may not be compatible with the player.

Video decoder

- Supports up to H.264, Level 4.1.
- H.264 FMO / ASO / RS, VC1 SP / MP / AP L4 and AVCHD are not supported.
- For all Video codecs except MVC, VP8, VP6:
 - Below 1280 x 720: 60 frame max
 - Above 1280 x 720: 30 frame max
 - GMC is not supported.
- Supports only SVAF Top/Bottom and Side by Side.
- Supports only BD MVC Spec.

Audio decoder

- WMA 9, 10 Pro supports up to 5.1 channel and M2 profile (except LBR mode of M0).
- WMA lossless audio is not supported.
- If Vorbis is only in Webm container, supports up to 2 channel.

Dimensions

■ Jack panel detail / Rear view

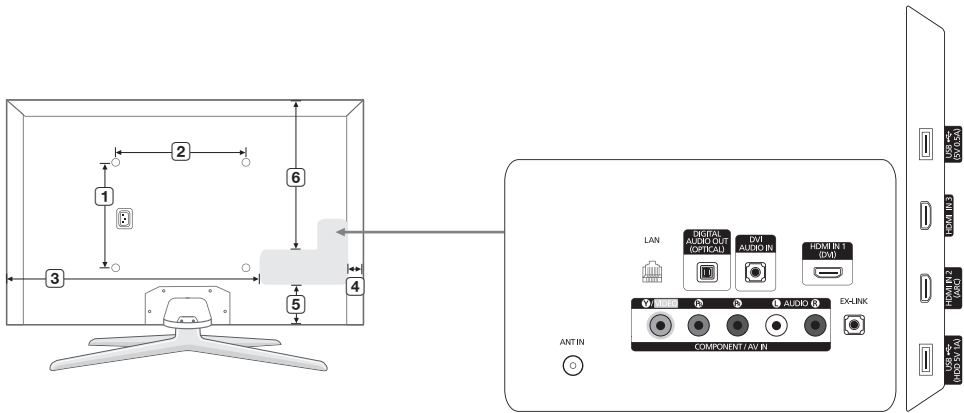

(Unit: inches)

Model name	1	2	3	4	5	6
PN51E6500	15.7	15.7	36.8	3.9	5.0	18.8
PN60E6500	15.7	23.6	40.6	7.4	7.8	20.4

NOTE: All drawings are not necessarily to scale. Some dimensions are subject to change without prior notice. Refer to the dimensions prior to performing installation of your TV. Not responsible for typographical or printed errors.

© 2012 Samsung Electronics America, Inc