

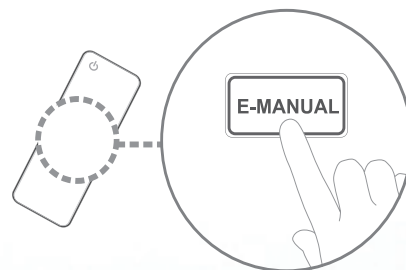

E-MANUAL



Thank you for purchasing this Samsung product.
To receive more complete service, please register
your product at

www.samsung.com/register

Model _____ Serial No. _____

Contents

Channel Menu

- Using the Channel Menu 1
- Memorizing Channels 17
- Other Features 22

Basic Features

- Changing the Preset Picture Mode 24
- Adjusting Picture Settings 25
- Changing the Picture Size 26
- Changing the Picture Options 31
- Using the TV with Your PC 38
- Changing the Preset Sound Modes 42
- Adjusting Sound Settings 43

Preference Features

- Wired Network Connection 51
- Wireless Network Connection 62
- Setting the Time 88
- Blocking Programs 95
- Economical Solutions 107
- Picture In Picture (PIP) 109
- Other Features 112
- Support Menu 126

Advanced Features

- **3D** 139
- **AllShare™** 151
- Anynet+(HDMI-CEC) 157
- Using the My Contents 167
- **Videos** 177
- **Music** 184
- **Photos** 186
- **My Contents** - Additional Functions 188

Other Information

- Troubleshooting 195
- Anti-theft Kensington Lock 207
- License 209

❑ Using the Channel Menu

Press the **CONTENT** button to select **Watch TV**, and then select the desired menu item. Choose from **Schedule Manager**, **Channel List**, and **Channel Manager**.



- The displayed image may differ depending on the model.

■ Schedule Manager

 CONTENT → Watch TV → Schedule Manager → ENTER 







To cancel or set **Timer Viewing**. **Timer Viewing** lets you display the channel you want at the time of your choice.

Using Timer Viewing

You can set the TV to display a desired channel automatically on a day and at a time of your choice.

 You must set the current time first using the **Time** → **Clock** function in the **System** menu to use this function.

To use **Timer Viewing**, follow these steps:

1. Press the **ENTER**  button to add a scheduled viewing.
2. Press the  /  /  /  buttons to set **Antenna**, **Channel**, **Repeat**, **Date**, and **Start Time**.
 - **Antenna**: Select the desired antenna source.
 - **Channel**: Select the desired channel.
 - **Repeat**: Select **Once**, **Manual**, **Sat~Sun**, **Mon~Fri** or **Everyday**. If you select **Manual**, you can set the day you want.
 -  The  mark indicates a day you are selected.

- **Date:** you can set a desired date.
 - ☑ **Date** is available only when you select **Once** in **Repeat**.
- **Start Time:** You can set the start time you want.
- ☑ You can only schedule memorized (added) channels.
- ☑ On the **Information** screen, you can change or cancel a scheduled viewing.
- **Cancel Schedules:** Cancel a scheduled viewing.
- **Edit:** Change a scheduled viewing.
- **Return:** Return to the previous screen.

■ Channel List

The **Channel List** contains the channels your TV displays (**Added Channels**) when you press the **Channel** button on your remote. On the **Channel List**, you can view **Added Channels**, channel information, **Favorites**, and manage channels.

 When you press the **CH LIST** button on the remote control, the **Channel List** screen is displayed at once.



- **Added Channels**: Shows all added (memorized) channels.
- **Favorites 1-5**: Shows all favorite channels, arranged in up to five groups. Each group has a separate screen.

 The TV displays **Favorites** only if you have added favorites using **Add to Favorites**.





- The displayed image may differ depending on the model.

- ✍ If you want to view the list of favorite channels, press the **CH LIST** button, and then press the **▶ (CH Mode)** button to display **Favorites 1-5**. If you have favorites in more than one Favorite Group, press the **◀▶ (CH Mode)** to view the other groups. Press the **◀** button to return to the **Channel List**.
- ✍ Using the colored and function buttons with the **Channel List**.
- **A** Red (**Antenna**): Switches the mode and display between **Air** or **Cable**.
 - **C** Yellow (**Program View / Channel View**): For digital channels, switches the display between **Program View** and **Channel View**. When you select a digital channel in **Channel View**, press once to display a list of programs on that channel. Press again to re-display the **Channel List**.



-  (**CH Mode**): Toggles between the **Favorites** list (if you have added favorites using **Add to Favorites**) and the **Channel List**.
-  (**Watch / Information**): Press to watch the channel you selected / Displays details of the selected program.
-  (**Page**): Scrolls the **Channel List** to the next or previous page.

Channel Status Display Icons

Icon	Description
	An analog channel.
	A reserved program.

How to use Timer Viewing in Channel List (digital channels only)



You can use **Timer Viewing** in **Channel List** to schedule a digital channel program for viewing. The TV will turn on and display the digital channel program when the program begins. To schedule a digital program, follow these steps:

1. Press the **CH LIST** button, then select a desired digital channel.
2. Press the **C** (**Program View**) button. The Program List for that channel appears.
3. Press the **▲** or **▼** buttons to select the desired program, and then press the **INFO** button.
4. Press the **◀** or **▶** buttons to select **Timer Viewing**, and then press the **ENTER**  button.
5. Press **RETURN** twice to exit.
 -  If you want to cancel **Timer Viewing**, follow Steps 1 through 3, and then select **Cancel Schedules**.

■ Channel Manager

 CONTENT → Watch TV → Channel Manager → ENTER 

Using **Channel Manager**, you can add, edit, or delete Added and Favorite channels. You can also add and edit channel names - for analog channels only.

- () **Added Ch.:** Shows all added channels.
- () **All Channels:** Shows all currently available channels. Includes channels that have not been added.
- () **Favorites 1-5:** Shows five favorite channels, arranged in up to five groups. Each group has a separate screen.



 Using the colored buttons with **Channel Manager**.

- **A** Red (**Antenna**): Switches between **Air** and **Cable**.
- **D** Blue (**Sorting**): Sorts the channel list by channel number or by channel name.





- The displayed image may differ depending on the model.

Using the Arrow buttons with **Channel Manager**







1. Highlight a channel in the first column on the left, and then press the Left arrow button. The Channel Manager sub-menu appears.
2. Use the Up or Down arrow buttons to select **Added Ch.**, **All Channels** or **Favorites 1** through **5**, and then press **ENTER**  or the Right arrow button. The cursor enters the screen you selected.
 -  If you have no favorites in a Favorite Group, the cursor will not enter that screen.

Channel Status Display Icons

Icon	Description
	An analog channel.
	A selected channel.
	A favorite channel.

Channel Manager Option Menu





Manage channels using the **Channel Manager** menu options (**Watch**, **Add to Favorites** / **Edit Favorites**, **Channel Name Edit**, **Add** / **Delete**, **Deselect All**, **Select All**). The Option menu items that appear may differ depending on the channel status and type.

1. Use the arrow buttons to select a channel, and then press the **ENTER**  button. A check appears next to the channel.
 -  You can select more than one channel by highlighting each channel with the cursor, and then pressing **ENTER** .
 -  Pressing **ENTER**  again deselects the channel.
2. Press the **TOOLS** button on your remote.
3. Select an option, and then press **ENTER**  to activate the option or change its settings.
 -  Exceptions: Select **All**. See the end of the **Channel Manager** section for information.





Options

- **Watch**: Watch the channel you selected. To use, select **Watch** on the Option menu, and then press **ENTER** .
- **Add to Favorites** / **Edit Favorites**: **Add to Favorites** appears if the channel you selected is not already a favorite. **Edit Favorites** appears if the channel you selected is already a favorite.





Using Add to Favorites to add a channel to the Favorites List:

1. Select **Add to Favorites**, and then press the **ENTER**  button. The **Add to Favorites** screen appears.
2. The **Add to Favorites** screen has five groups, Favorites 1, Favorites 2, etc. You can add a favorite channel to any one of the groups. Select a group using the up and down arrows on your remote, and then press **ENTER** .
3. Select **OK**, press **ENTER** , and then press **ENTER**  again.

Using Edit Favorites to delete a channel from the Favorites List:

1. Select **Edit Favorites**, and then press the **ENTER**  button. The **Edit Favorites** screen appears.
2. The Favorites Group you assigned the channel to is checked. Select the group, and then press **ENTER** . The check disappears.
3. Select **OK**, press **ENTER** , and then press **ENTER**  again.

Using Edit Favorites to move a channel from one Favorites Group to another:





1. Select **Edit Favorites**, and then press the **ENTER**  button. The **Edit Favorites** screen appears.
2. The Favorites Group you assigned the channel to is checked. Select the group, and then press **ENTER** . The check disappears.
3. Use the Up or Down arrow key to highlight a different group, and then press **ENTER** . A check appears by the group's name.
4. Select **OK**, press **ENTER** , and then press **ENTER**  again.

- **Channel Name Edit** (analog channels only): Assign a name of up to five characters to a channel. For example, Hist, Food, Golf, etc. This makes it easier to find and select the channel.
- **Add / Delete**: Add a channel to or delete a channel from the **Channel Manager**. When you use the Channel button on your remote to change channels, your TV only displays the channels on the **Channel Manager**.

Deleting a Channel from the Channel List:

1. Select **Delete**, and then press the **ENTER**  button. The Delete pop-up appears.
2. Select **OK** on the pop-up, press **ENTER** , and then press **ENTER**  again.

Adding a Channel to the Channel List:

1. Select a deleted channel on the **All Channels** list, and then press the **ENTER**  button.
 -  Deleted channels are grayed out.
2. Press the **TOOLS** button on your remote. The Options menu appears.
3. Select **Add**, press **ENTER** , and then press **ENTER**  again.

NOTE

- Your TV will display all channels, including channels you deleted from the **Channel Manager**, on the **All Channels** list.
- A gray-colored channel on the **All Channels** list indicates the channel has been deleted from the **Channel Manager**.
- The **Add** menu only appears for deleted channels.

- **Deselect All:** Deselect all the selected channels.
 - ☑ You can only select **Deselect All** when you have selected one or more channels.
- **Select All:** Select all the channels in the channel list. To use, choose **Select All** in the Options menu, and then press **ENTER** . All channels are selected and a check appears by each channel. You can then apply one of the other options on the Options menu to all the selected channels.



❑ Memorizing Channels

 MENU  → Channel → ENTER 

■ Antenna (Air / Cable)

To select **Air** or **Cable**, follow these steps:

Your TV memorizes channels and adds the memorized channels to the **Channel Manager** with the **Auto Program** function. Before your TV can memorize channels, you must specify the signal source, either **Air** or **Cable**. If you select **cable**, when you start **Auto Program**, you must also specify the cable system type, **STD**, **HRC**, or **IRC**. If you don't know your cable system type, contact your local cable company for the information. Most cable companies use **STD**.







1. Push **MENU**  → **Channel** → **ENTER**  on your remote.
2. Select **Antenna**, and then press **ENTER** .
3. Select the source of your TV signal, **Air** or **Cable**, and then press the **RETURN** button.







■ Auto Program





Scans for channels automatically and stores them in the TV's memory.

To start **Auto Program**, follow these steps:

1. Push **MENU**  → **Channel** → **ENTER**  on your remote.
2. Select **Auto Program**, and then press **ENTER** .
3. Select **Air** or **Cable** or both by highlighting and then pressing **ENTER** .
-  If you selected **Air** or **Cable** or both on the Antenna screen, your choice will already be selected.
4. Select **Search** or **Next**, and then press **ENTER** .

5. If you selected **Cable**, the Cable System screen appears. Select **Digital**, and then press **ENTER** .
-  If you selected **Air** only, **Auto Program** starts.
6. Select **STD**, **HRC**, or **IRC**, and then press **ENTER** .
7. Repeat for Analog.
8. Select **Search** or **Next**, and then press **ENTER** . **Auto Program** starts.
-  After all the available channels are stored, **Auto Program** removes scrambled channels. When done, the **Auto Program** menu then reappears. This process can take up to 30 minutes.

How to Stop Auto Programming

1. Press the **ENTER**  button.
2. A message will ask **Stop Auto Program?** Select **Yes** by pressing the  or  button.
3. Press the **ENTER**  button.





❑ Other Features

 MENU  → Channel → ENTER 

■ Clear Scrambled Channel

This function filters out scrambled channels after **Auto Program** is completed. This process may take up to 20~30 minutes.

How to Stop the clear Scrambled Channels function

1. Press the ENTER  button to select **Stop**.
2. Press the  button to select **Yes**.
3. Press the ENTER  button.

 This function is only available in **Cable** mode.

■ Fine Tune

(analog channels only)

If the reception is clear, you do not have to fine tune the channel, as this is done automatically during the search and store operation. If the signal is weak or distorted, fine tune the channel manually. Scroll to the left or right until the image is clear.

- ☑ Settings are applied to the channel you're currently watching.
- ☑ Fine tuned channels that have been saved are marked with an asterisk "*" on the right-hand side of the channel number in the channel banner.
- ☑ To reset the fine-tuning, select **Reset**.

❑ Changing the Preset Picture Mode

 MENU  → **Picture** → **Picture Mode** → ENTER 

■ Picture Mode

Picture modes apply preset adjustments to the picture. Select a mode using the up and down arrow keys, and then press the **ENTER**  button.



 When connecting a PC, you can only select **Entertain** and **Standard**.





- **Dynamic**: Suitable for a bright room.
- **Standard**: Suitable for a normal environment.
- **Movie**: Suitable for watching movies in a dark room.
- **Entertain** (When connecting a PC): Suitable for watching movies and games.

❑ Adjusting Picture Settings

 MENU  → **Picture** → ENTER 

■ **Cell Light / Contrast / Brightness / Sharpness / Color / Tint (G/R)**



Your television has several options for adjusting picture quality. Select an option using the up and down arrow keys, and then press **ENTER** . Use the arrow keys to adjust the option value or select an option setting. When done, press **ENTER** .

- ◀  When you make changes to **Cell Light, Contrast, Brightness, Sharpness, Color** or **Tint (G/R)**, the OSD will be adjusted accordingly. ▶
-  When connecting a PC, you can only make changes to **Cell Light, Contrast, Brightness**, and **Sharpness**.
-  You can adjust and store settings for each external device connected to the TV.
-  Lowering picture brightness reduces power consumption.

❑ Changing the Picture Size

 MENU  → **Picture** → **Screen Adjustment** → ENTER 

■ Screen Adjustment

Screen Adjustment provides various picture size and aspect ratio options. Select an option using the up and down arrow keys, and then press **ENTER** . Use the arrow keys to select an option in the sub-menu, and then press **ENTER** .

- **Picture Size:** If you have a cable box or satellite receiver, it may have its own set of screen sizes as well. However, we highly recommend you use your TV's 16:9 mode most of the time.

16:9: Sets the picture to 16:9 wide screen mode.

Zoom1: Use for moderate magnification. Cuts off the top and sides.

Zoom2: Use for a stronger magnification.

Wide Fit: Enlarges the aspect ratio of the picture so it fits the entire screen.

 Available with HD 1080i / 720p signals in 16:9 mode.



4:3: Sets the picture to (4:3) mode. For analog TV programs.



 Do not set your TV to 4:3 format for a long time. The borders displayed on the left and right, or top and bottom of the screen may cause image retention (screen burn) which is not covered by the warranty.

Screen Fit: When your TV inputs HDMI (720p / 1080i / 1080p) or Component (1080i / 1080p) signals, displays the full image without any cut-off.









- **Position**: Adjusts the picture position. **Position** is only available if Picture size is set to **Zoom1**, **Zoom2**, **Wide Fit**, or **Screen fit**.

 To use the Position function after selecting **Zoom1**, **Zoom2** or **Wide Fit**, follow these steps:

1. Press the ▼ button to select **Position**.
2. Press the ENTER  button.
3. Press the ▲ or ▼ button to move the picture up or down.
4. Press the ENTER  button.
5. Select **Close** by pressing the ▼ and ► buttons sequentially. To reset the picture position, press **Reset**.

 If you want to reset the pictures to its original position, select **Reset** in the **Position** screen, and then press ENTER . The picture will be reset to its default position.

 To use the **Position** function after selecting **Screen Fit** when connected to an HDMI (1080i/1080p) or Component (1080i/1080p) source, follow these steps:

1. Press the  button to select **Position**.
2. Press the **ENTER**  button.
3. Press the , ,  or  button to move the picture.
4. Press the **ENTER**  button.
5. Select **Close** by pressing the  and  buttons sequentially.

 If you want to reset the pictures to its original position, select **Reset** in the **Position** screen. The picture will be set to its default position.

- HD (High Definition): 16:9 - 1080i / 1080p (1920x1080), 720p (1280x720)
- You can adjust and store settings for each external device you have connected to an input on the TV.
- Picture Sizes available by Input Source:



Input Source	Picture Size
ATV, AV, Component (480i, 480p)	16:9, Zoom1, Zoom2, 4:3
DTV(1080i), Component (1080i, 1080p), HDMI (720p, 1080i, 1080p)	16:9, 4:3, Wide Fit, Screen Fit
PC	16:9, 4:3

❑ Changing the Picture Options

■ Advanced Settings

🖱️ MENU  → **Picture** → **Advanced Settings** → ENTER 

Advanced Settings are available in the **Standard** and **Movie** modes. When connecting a PC, you can only make changes to **Gamma** and **White Balance**. They are not available when you are watching a digital channel.

To use, select an option using the up and down arrow keys, and then press **ENTER** . Use the arrow keys to change a value or setting, and then press **ENTER** .

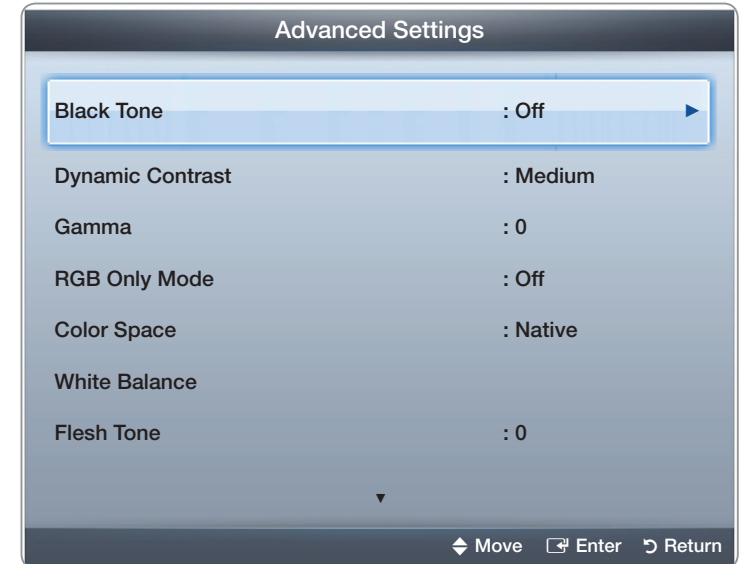

- The displayed image may differ depending on the model.

- **Black Tone (Off / Dark / Darker / Darkest)**: Select the black level to adjust the screen depth.
- **Dynamic Contrast (Off / Low / Medium / High)**: Adjusts the screen contrast.
- **Gamma**: Adjusts the primary color intensity.
- **RGB Only Mode (Off / Red / Green / Blue)**: Displays the **Red**, **Green** and **Blue** color for making fine adjustments to hue and saturation.



- **Color Space (Auto / Native)**: Adjusts the range of colors (the color gamut) available to create images.

- **White Balance**: Adjusts the color temperature for a more natural picture.

R-Offset / G-Offset / B-Offset: Adjusts each color's (red, green, blue) darkness.

R-Gain / G-Gain / B-Gain: Adjusts each color's (red, green, blue) brightness.

Reset: Resets the White Balance to its default settings.

- **Flesh Tone**: Emphasizes pink "Flesh Tone."
- **Edge Enhancement (Off / On)**: Emphasizes object boundaries.
- **Motion Lighting (Off / On)**: Reduces power consumption by reducing screen brightness when the picture on the screen is in motion.

 **3D** is not supported.

 When you change the **Cell Light**, **Contrast**, or **Brightness**, the TV sets **Motion Lighting** to **Off**.

■ Picture Options

 MENU  → **Picture** → **Picture Options** → ENTER 

Select an option using the up and down arrow keys, and then press **ENTER** .

Use the arrow keys to change the setting, and then press **ENTER** .

 When connecting a PC, you can only make changes to **Color Tone**.

- **Color Tone** (**Cool** / **Standard** / **Warm1** / **Warm2**)

 **Warm1** or **Warm2** will be deactivated when the picture mode is **Dynamic**.

 You can adjust and store settings for each external device connected to an input on the TV.

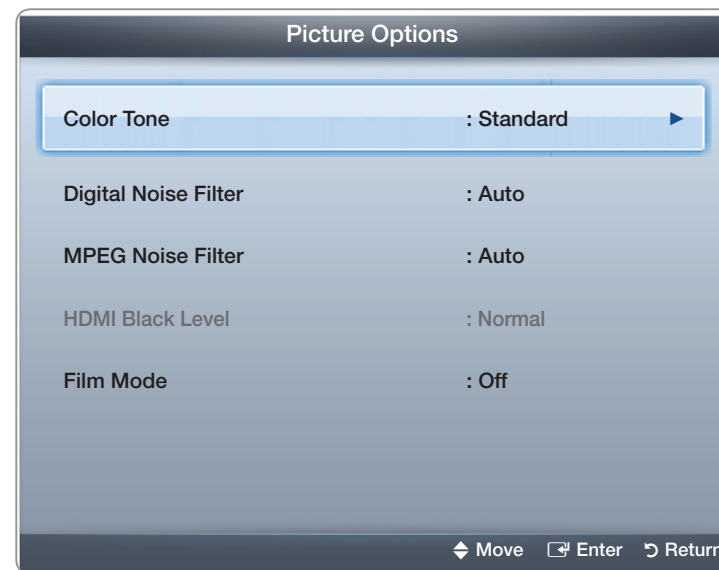

- The displayed image may differ depending on the model.

- **Digital Noise Filter (Off / Low / Medium / High / Auto / Auto Visualization):** If the broadcast signal received by your TV is weak, you can activate the **Digital Noise Filter** feature to reduce any static and ghosting that may appear on the screen.



☞ When the signal is weak, try each option until the the TV displays the best picture.

Auto Visualization: When changing analog channels, displays signal strength.

☞ Only available for analog channels.

☞ When the bar is green, you are receiving the best possible signal.

- **MPEG Noise Filter (Off / Low / Medium / High / Auto):** Reduces MPEG noise to provide improved picture quality.

- **HDMI Black Level (Low / Normal)**: Lets you select the black level on the screen to adjust the screen depth.
 Available only in **HDMI** mode.
- **Film Mode (Off / Auto1 / Auto2 / Cinema Smooth for PDP 550 Series and above)**: Sets the TV so that it senses and then processes film signals from all sources automatically and adjusts the picture for optimum quality. The **Cinema Smooth** function is only activated when the TV inputs an HDMI 24Hz signal.
 Available in TV, AV, COMPONENT (480i / 1080i) and HDMI (1080i).

■ **Reset Picture (OK / Cancel)**

Resets your current picture mode to its default settings.



❑ Using the TV with Your PC

Set the input source to PC.

■ Auto Adjustment

 MENU  → **Picture** → **Auto Adjustment** → ENTER 

Automatically adjusts the picture's frequency, position, and fine tune settings in the **PC** mode.



 Available in **PC** mode only.

 Not available if you connect your PC with an HDMI to DVI cable.

■ PC Screen Adjustment

 MENU  → **Picture** → **Screen Adjustment** → **PC Screen Adjustment** →
ENTER 

 Available in **PC** mode only.

- **Coarse / Fine**: Removes or reduces picture noise. If the noise is not removed by Fine-tuning alone, use the **Coarse** function to adjust the frequency as best as possible (**Coarse**) and Fine-tune again. After the noise has been reduced, re-adjust the picture so that it is aligned to the center of screen.
- **Position**: To adjust the PC's screen position if it is not centered or does not fit the TV screen. Press the u or d button to adjust the vertical position. Press the  or  button to adjust the horizontal position.
- **Image Reset**: Resets the image to the default settings.

Using Your TV as a Computer (PC) Display

Entering the Video Settings (Based on Windows XP)

For your TV to work properly as a computer display, you must enter the correct video settings into your PC.

- ☞ Depending on your version of Windows and your video card, the procedure on your PC will probably differ slightly from the procedure presented here. However, the same basic information will apply in most cases. (If not, contact your computer manufacturer or Samsung Dealer.)

1. On your PC, click “Control Panel” on the Windows start menu.
2. Click “Appearance and Themes” in the “Control Panel” window, A display dialog-box appears.
3. Click “Display”. Another display dialog box appears.
4. Click the “Settings” tab on the display dialog-box.
 - On the Settings tab, set the correct resolution.
 - If a vertical-frequency option exists on your display settings dialog box, select “60” or “60 Hz”. Otherwise, just click “OK” and exit the dialog box.

❑ Changing the Preset Sound Modes

 MENU  → **Sound** → **Sound Mode** → ENTER 

■ **Sound Mode**

Use the up and down arrow keys to select an option, and then press ENTER .

- **Standard**: Selects the normal sound mode.
- **Music**: Emphasizes music over voices.
- **Movie**: Provides the best sound for movies.
- **Clear Voice**: Emphasizes voices over other sounds.
- **Amplify**: Increase the intensity of high-frequency sound to allow a better listening experience for the hearing impaired.

 If **Speaker Select** is set to **External Speaker**, **Sound Mode** is disabled.

□ Adjusting Sound Settings

 MENU  → **Sound** → ENTER 

■ Sound Effect

 If **Speaker Select** is set to **External Speaker**, **Sound Effect** is disabled.

- **SRS TruSurround HD (Off / On)**

(standard sound mode only)



◀ This function provides a virtual 5.1 channel surround sound experience through a pair of speakers using HRTF (Head Related Transfer Function) technology. ▶

- **SRS TruDialog (Off / On)**

(standard sound mode only)

This function allows you to increase the intensity of a voice over background music or sound effects so that dialog can be heard more clearly.

- **Equalizer**

The Equalizer displays a series of sliders. Use the up and down arrow keys to select a slider. Use the left and right arrow keys to change the slider's value. To Reset the **Equalizer**, select **Reset** and press **ENTER** , then press **ENTER**  again. To exit, select **Close**, and then press **ENTER** . Equalizer is available in the standard sound mode only.

- **Balance L/R**: Adjusts the balance between the right and left speaker.
- **100Hz / 300Hz / 1kHz / 3kHz / 10kHz** (Bandwidth Adjustment): Adjusts the volume level of specific bandwidth frequencies.
- **Reset**: Resets the equalizer to its default settings.

■ Broadcast Audio Options

- Preferred Language

(digital channels only)

Use the up and down arrow keys to select a language, and then press **ENTER** .

Digital-TV broadcasts can simultaneously transmit many audio tracks (for example, simultaneous translations of the program into foreign languages).

 You can only select a language from among the ones being broadcasted.

- **Multi-Track Sound (MTS)** 

(analog channels only)

Select an option using the up and down arrow keys, and then press **ENTER** .

Mono: Choose for channels that are broadcasting in mono or if you are having difficulty receiving a stereo signal.

Stereo: Choose for channels that are broadcasting in stereo.

SAP: Choose to listen to the Separate Audio Program, which is usually a foreign-language translation.

 Depending on the program being broadcast, you can listen to **Mono**, **Stereo**, or **SAP**.

■ SPDIF Output

The SPDIF (Sony Philips Digital InterFace) outputs an uncompressed digital audio signal when you connect the digital audio jack on the back of the TV to a digital audio in jack on a receiver or home theater.

- **Audio Format:** You can select the Digital Audio output (SPDIF) format.
 - ☑ The available Digital Audio output (SPDIF) format may differ depending on the input source.
- **Audio Delay:** Lets you correct timing mismatches between the audio track and the video when you are watching the TV and listening to digital audio output from the TV through an external device such as an AV receiver. When you select Audio Delay, a slider appears. Use the left and right arrow buttons to adjust the slider. Press **ENTER**  when done (0ms ~ 250ms).

■ Speaker Settings

- **Speaker Select (External Speaker / TV Speaker)**

If you are listening to the sound track of a broadcast or movie through an external receiver, you may hear a sound echo caused by the difference in decoding speed between the TV's speakers and the speakers attached to your audio receiver. If this occurs, set the TV to **External Speaker**.

☑ When you set Speaker Select to **External Speaker**, the TV's speakers are turned off. You will hear sound through the external speakers only. When you set **Speaker Select** to **TV Speaker** both the TV's speakers and the external speakers are on. You will hear sound through both.

☑ When **Speaker Select** is set to **External Speaker**, the **–VOL+** and **MUTE** buttons will not operate and the sound settings will be limited.

☑ If there is no video signal, both speakers will be mute.

- **Auto Volume (Off / Normal / Night)**

Normal equalizes the volume level on each channel, so that when you change channels, the volume level is the same.

Night equalizes and decrease the volume level on each channel, so each channel is quieter. **Night** is useful at night, when you may want to keep the volume low.

 To use the volume control of a connected source device, set **Auto Volume** to **Off**. A change to the volume control of the connected source device may not be applied if **Auto Volume** is set to **Normal** or **Night**.

■ **Reset Sound (OK / Cancel)**

Reset all sound settings to the factory defaults. Select Reset, press **ENTER** , select OK on the pop-up, and then press **ENTER**  again.



❑ Wired Network Connection

■ Connecting to a Wired Network for PDP 550 Series and above

There are three ways to attach your TV to your LAN using cable:

- You can attach your TV to your LAN by connecting the LAN port on the back of your TV to an external modem using a LAN cable. See the diagram below.

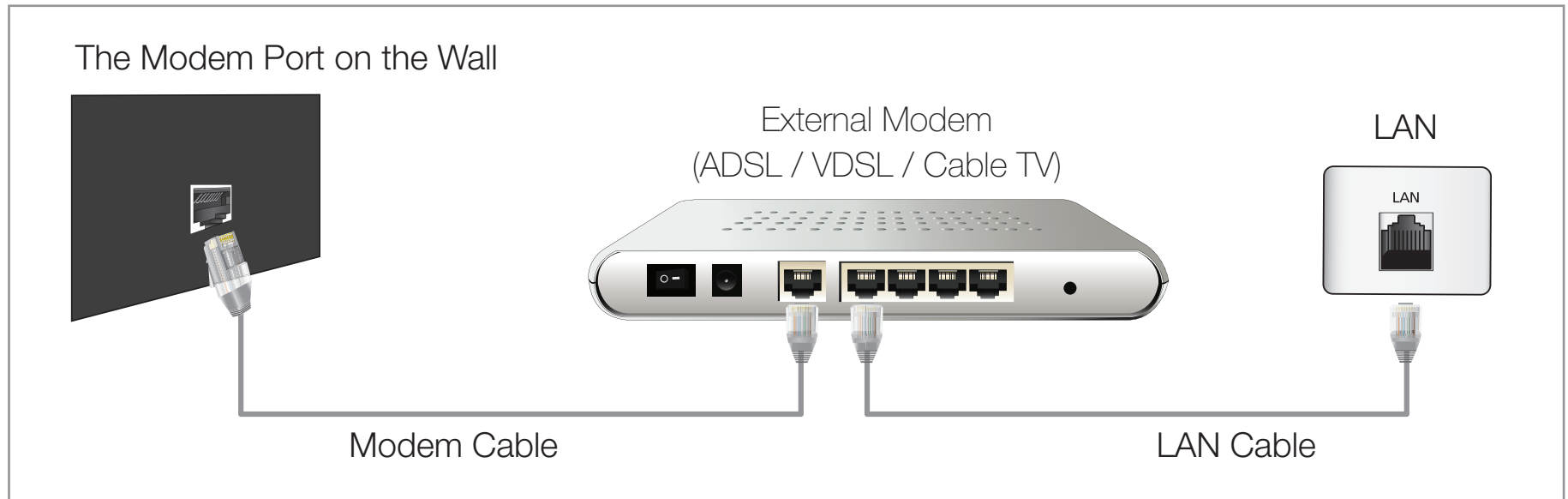

- You can attach your TV to your LAN by connecting the LAN port on the back of your TV to a IP Sharer (router) which is connected to an external modem. Use LAN cable for the connection. See the diagram below.

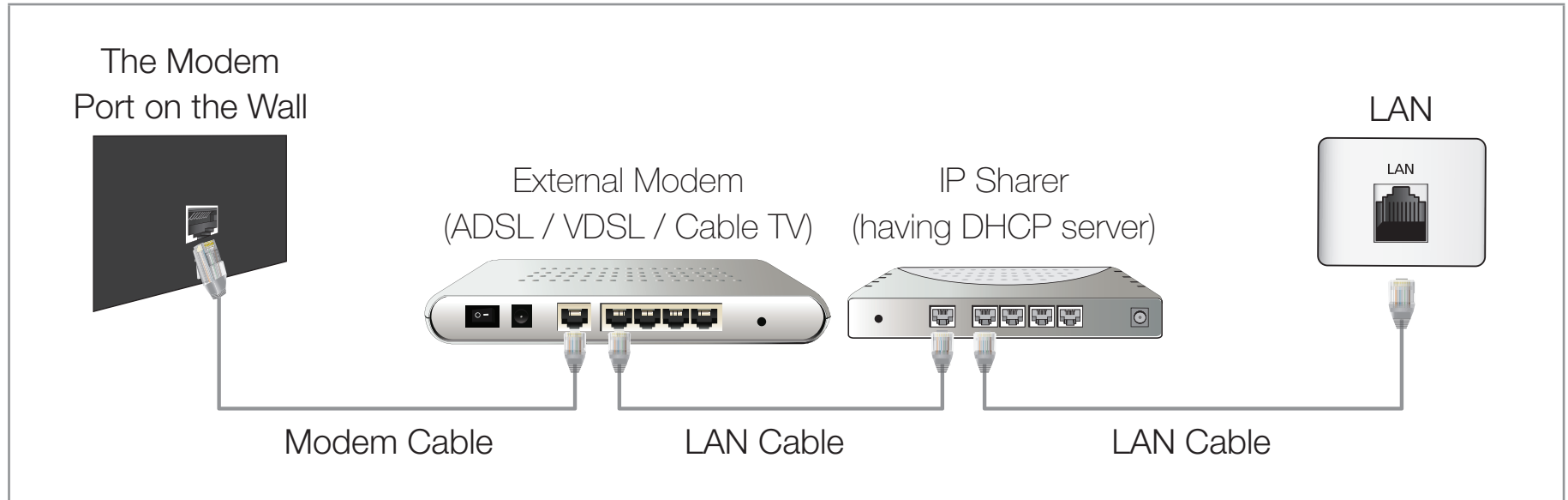

- Depending on how your network is configured, you may be able to attach your TV to your LAN by connecting the LAN port on the back of your TV directly to a network wall outlet using a LAN cable. See the diagram below. Note that the wall outlet is attached to a modem or router elsewhere in your house.

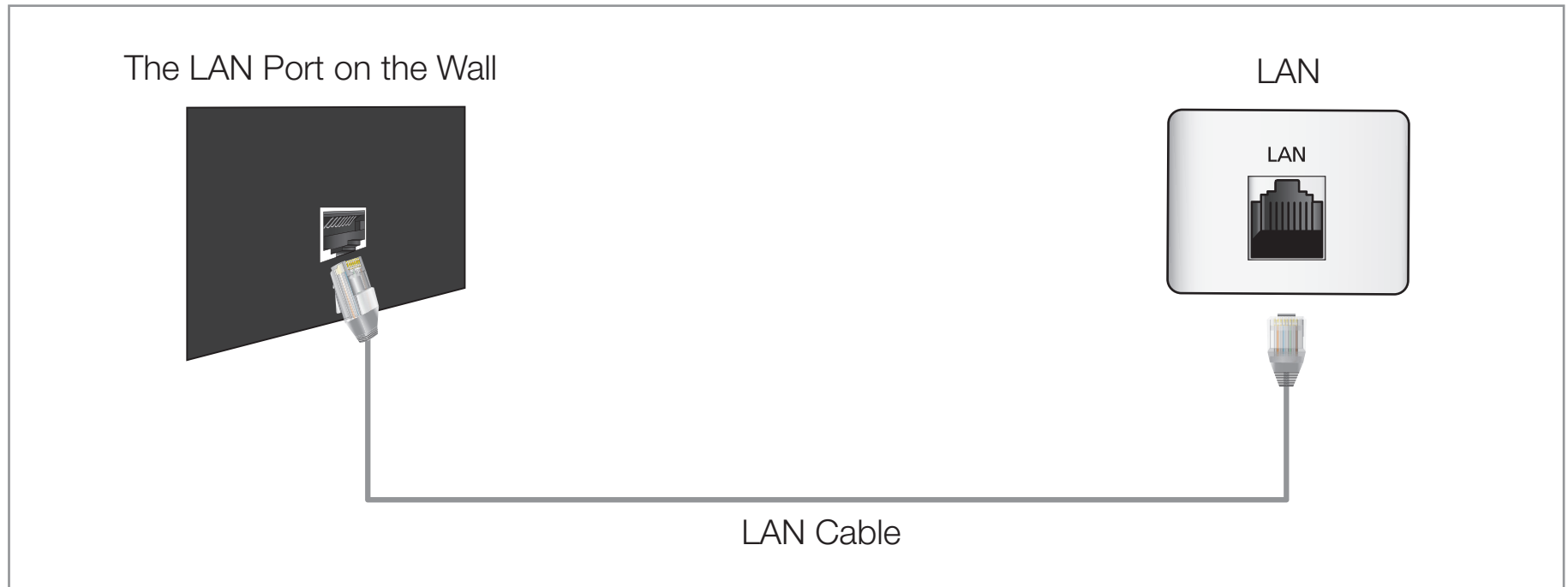

- If you have a Dynamic Network, you should use an ADSL modem or router that supports the Dynamic Host Configuration Protocol (DHCP). Modems and routers that support DHCP automatically provide the IP address, subnet mask, gateway, and DNS values your TV needs to access the Internet so you do not have to enter them manually. Most home networks are Dynamic Networks.

Some networks require a Static IP address. If your network requires a Static IP address, you must enter the IP address, subnet mask, gateway, and DNS values manually on your TV's Cable Setup Screen when you set up the network connection. To get the IP address, subnet mask, gateway, and DNS values, contact your Internet Service Provider (ISP). If you have a Windows computer, you can also get these values through your computer.

- ☑ You can use ADSL modems that support DHCP if your network requires a Static IP address. ADSL modems that support DHCP also let you use Static IP addresses.

■ Network Settings

 MENU  → Network → Network Settings → ENTER 

Set up your network connection so you can use various Internet services such as **My Contents**, AllShare™ and perform software upgrades.

■ Network Status

 MENU  → Network → Network Status → ENTER 

Lets you check the current network and Internet status.

■ AllShare Settings



 MENU  → Network → AllShare Settings → ENTER 

Lets you select whether to use media functions on the network. For details on set up options, refer to the “AllShare™” instructions.

■ Automatic Network Setup

Use the Automatic **Network Setup** when connecting your TV to a network that supports DHCP. To set up your TV's cable network connection automatically, follow these steps:

How to set up automatically

1. Go to the **Network Settings** screen.
(MENU  → **Network** → **Network Settings** → ENTER )
2. Select **Wired**, and then press ENTER .
3. The network test screen appears and verifies the network connection. When the connection has been verified, the “Internet connection successful.” message appears.

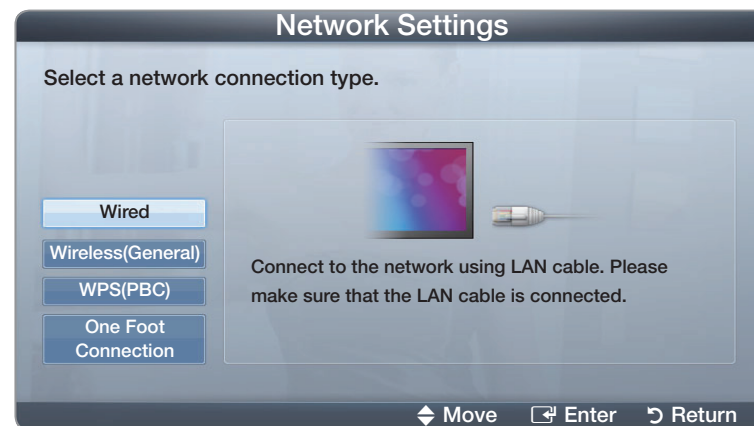

- The displayed image may differ depending on the model.

- ✎ If the connection process fails, check the LAN port connection.
- ✎ If the automatic process cannot find the network connection values or if you want to set the connection manually, go to the next section, Manual Network Setup.



- The displayed image may differ depending on the model.

■ Manual Network Setup

Use the Manual Network Setup when connecting your TV to a network that requires a Static IP address.





Getting the Network Connection Values

To view the Network connection values on most Windows computers, follow these steps:

1. Right click the Network icon on the bottom right of the screen.
2. In the pop-up menu that appears, click Status.
3. On the dialog that appears, click the Support tab.
4. On the Support Tab, click the Details button. The Network connection values are displayed.



How to set up manually

To set up your TV's cable network connection manually, follow these steps:

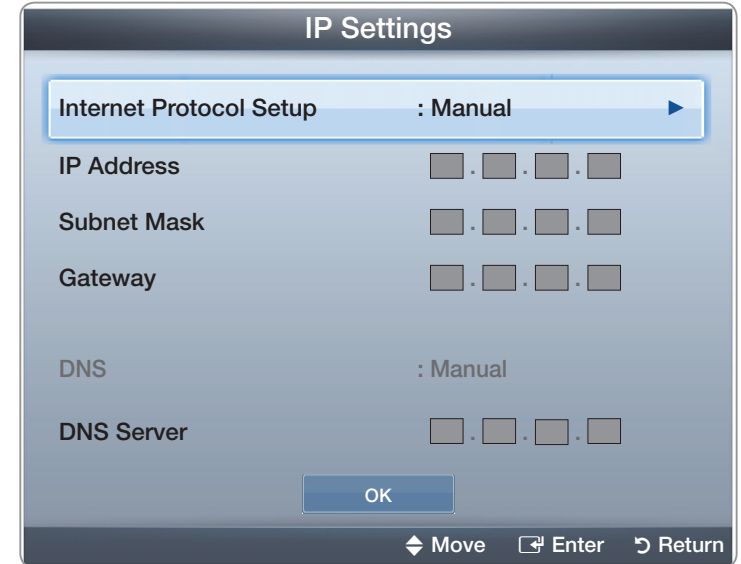

1. Go to the **Network Settings** screen. (MENU 
→ **Network** → **Network Settings** → ENTER )
2. Select **Wired**, press ENTER , then press ENTER  again. The network test screen appears and the verification process starts.
3. Press ENTER . The verification process stops. Select **IP Settings** on network test screen. The **IP Settings** screen appears.



- The displayed image may differ depending on the model.

4. In the top entry field, press **ENTER** , and then set **IP Mode** to Manual.
5. Press the  button on your remote to go to the IP Address entry field, and then press **ENTER** .
6. Enter the first portion of the IP Address (for example, 105) into the first entry field using the number keys on your remote. Press the right arrow button to go to the next field.
7. Enter the next portion of the **IP Address**. Press the right arrow button to go to the next field.



8. Repeat the entry process for each field in the IP Address.
 - ✎ If you make a mistake when entering a number, re-enter the number to correct it. You can also press the up or down arrow button to change the number one unit at a time.
9. When done entering the **IP Address**, press **ENTER** .
10. Press the down arrow key to go to the **Subnet Mask** fields, and then press **ENTER** .
11. Repeat the same entry process for **Subnet Mask**, **Gateway**, and **DNS Server**.
12. When done, select **OK** at the bottom of the page, and then press **ENTER** .

The network test screen appears and the verification process starts. When the connection has been verified, the “Internet connection successful.” message appears.

❑ Wireless Network Connection

■ Connecting to a Wireless Network for PDP 550 Series and above

To connect your TV to your wireless network, you need a wireless router or modem and a Samsung Wireless LAN adapter (WIS09ABGN, WIS09ABGN2, or WIS10ABGN), which you connect to your TV's back or side panel USB jack. See the illustration below.

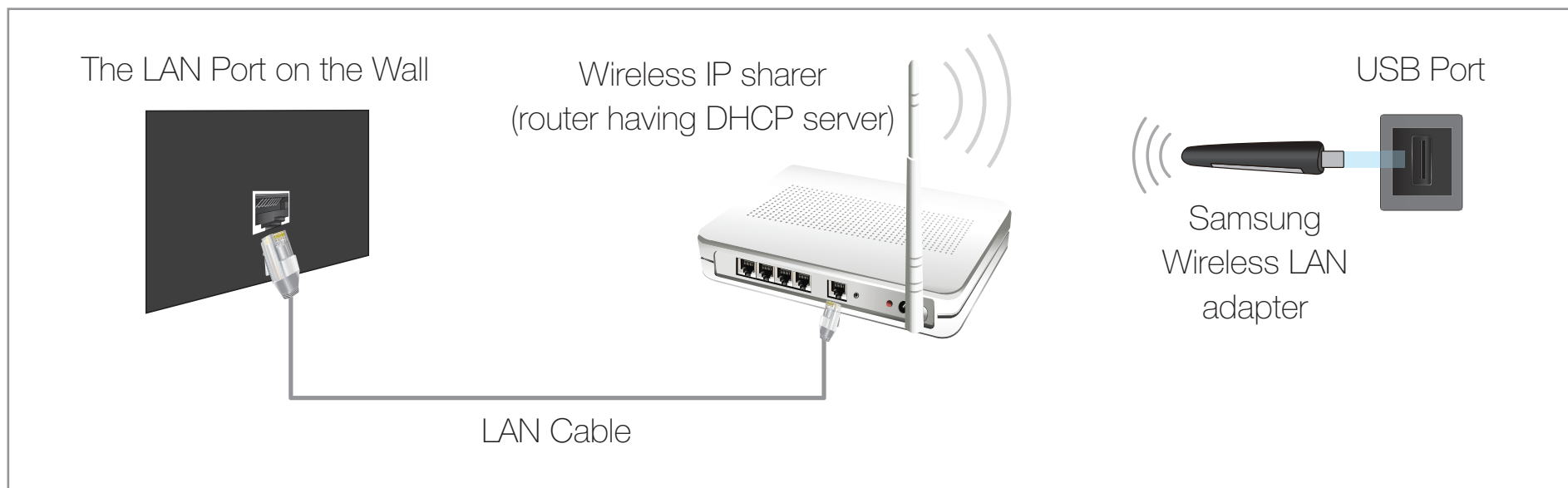

Samsung's Wireless LAN adapter is sold separately and is offered by select retailers, Ecommerce sites, and Samsungparts.com. Samsung's Wireless LAN adapter supports the IEEE 802.11a/b/c and n communication protocols. Samsung recommends using IEEE 802.11n. When you play video over a network connection, the video may not be played smoothly.

 NOTE

- You must use the “Samsung Wireless LAN adapter” (WIS09ABGN, WIS09ABGN2, or WIS10ABGN) to use a wireless network.
- To use a wireless network, your TV must be connected to a wireless IP sharer (either a router or a modem). If the wireless IP sharer supports DHCP, your TV can use a DHCP or static IP address to connect to the wireless network.

- Select a channel for the wireless IP sharer that is not currently being used. If the channel set for the wireless IP sharer is currently being used by another device nearby, this will result in interference and communication failure.
- Your TV supports the following wireless security systems only:
 - Authentication Mode : WEP, WPAPSK, WPA2PSK
 - Encryption Type : WEP, AES
- If you select the Pure High-throughput (Greenfield) 802.11n mode and the Encryption type is set to WEP, TKIP or TKIP AES (WPS2Mixed) on your wireless router, Samsung TVs will not support a connection in compliance with new Wi-Fi certification specifications.

- If your AP supports WPS (Wi-Fi Protected Setup), you can connect to the network via PBC (Push Button Configuration) or PIN (Personal Identification Number). WPS will automatically configure the SSID and WPA key in either mode.
- If your router, modem, or device is not certified, it may not connect to the TV via the “Samsung Wireless LAN adapter.”
- Ensure the TV is turned off before you connect the Samsung Wireless LAN adapter.



- Connection Methods: You can setup the wireless network connection in five ways:
 - Auto Setup (Using the Auto Network Search function)
 - Manual Setup
 - **WPS(PBC)**
 - **One Foot Connection**
 - **Plug & Access**
- ◀ ● The TV may not recognize the Samsung Wireless LAN adapter if it is connected ▶ to the TV using a USB hub or USB extension cable other than the cable supplied.

Notice

The picture may appear corrupted or have static on some channels when the TV is connected to the Samsung Wireless LAN adapter. If this occurs, connect the Samsung Wireless LAN adapter using a USB cable in a place that is not affected by radio interference.

To connect the Samsung Wireless LAN adapter using the extension cable, follow these steps:

1. Connect the extension cable to the **USB** port.
2. Connect the extension cable and Samsung Wireless LAN adapter.
3. Attach the Samsung Wireless LAN adapter to the back of the TV near the top, using double-sided adhesive tape.

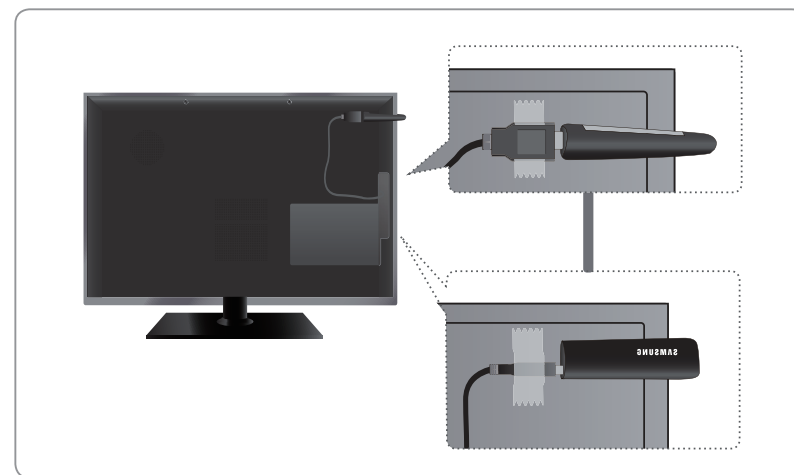





- The displayed image may differ depending on the model.

■ Automatic Network Setup



Most wireless networks have an optional security system that requires devices that access the network to transmit an encrypted security code called an Access or Security Key. The Security Key is based on a Pass Phrase, typically a word or a series of letters and numbers of a specified length you were asked to enter when you set up security for your wireless network. If you use this method of setting up the network connection, and have a Security Key for your wireless network, you will have to enter the Pass Phrase during the automatic or manual setup process.

How to set up automatically

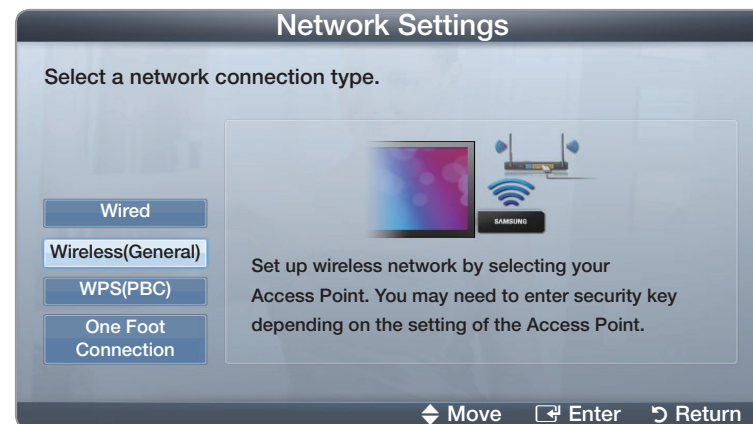
1. Go to the **Network Settings** screen.
(MENU  → **Network** → **Network Settings** → ENTER .
2. Select **Wireless (General)**, press ENTER , and then press ENTER  again.



- The displayed image may differ depending on the model.

3. The **Network** function searches for available wireless networks. When done, it displays a list of the available networks.
4. In the list of networks, press the ▲ or ▼ button to select a network, and then press the **ENTER**  button twice.
 -  If the wireless router is set to Hidden (Invisible), you have to select **Add Network** and enter the correct **Network Name (SSID)** and **Security key** to establish the connection.
5. If the **Enter Security Key** screen appears, go to step 6. If you select an wireless router that does not have security, go to step 7.



6. If the wireless router has security, enter the Security key (Security key or PIN).

☞ When you enter the **Security key** (**Security key** or **PIN**), use ▲ / ▼ / ◀ / ▶ buttons on your remote to select number/characters. Press **ENTER**  button to enter the characters.

☞ You can also enter numbers by pressing the number buttons on your remote.



- The displayed image may differ depending on the model.

7. When done, use the right arrow button to move the cursor to **Done**, and then press **ENTER** .
8. The network test screen appears and the verification process starts. When the connection has been verified, the “Internet connection successful.” message appears.
 -  If the network does not accept the Security key (**Security key** or **PIN**), select **Retry** or select **IP Settings** to enter the settings manually.
 -  If you want to set up the connection manually, select **IP Settings**. Then, go to the next section, “How to set up manually”.

■ Manual Network Setup

Use Manual Network Setup when connecting your TV to a network that requires a Static IP address or if the automatic connection process has failed.

Getting the Network Connection Values

To view the Network connection values on most Windows computers, follow these steps:

1. Right click the Network icon on the bottom right of the screen.
2. In the pop-up menu that appears, click Status.
3. On the dialog that appears, click the Support tab.
4. On the Support Tab, click the Details button. The Network connection values are displayed.

How to set up manually

To set up your TV's cable network connection manually, follow these steps:

1. Go to the **Network Settings** screen.

(MENU  → **Network** → **Network Settings** → ENTER )

2. Select **Wireless (General)**, and then press the ENTER  button.

3. The Network function searches for available wireless networks. When done, it displays a list of the available networks.

4. In the list of networks, press the ▲ or ▼ button to select a network, and then press the ENTER  button twice.

 If the wireless router is set to Hidden (Invisible), you have to select **Add Network** and enter the correct network Name (SSID) and Security key to establish the connection.





5. If the Enter Security key screen appears, go to step 6. If you selected an AP or wireless router that does not have security, go to step 8.

6. Enter the Security key (Security key or PIN).

 When you enter the **Security key** (**Security key** or **PIN**), use the ▲ / ▼ / ◀ / ▶ buttons on your remote to select number/characters. Press **ENTER** to enter the characters.

 You can also enter numbers by pressing the number buttons on your remote.

 You should be able to find the Pass Phrase on one of the set up screens you used to set up your router or modem.

7. When done, use the ► button to move the cursor to **Done**, and then press the ENTER  button.
8. The network test screen appears and the verification process starts. Press ENTER  to cancel. Select **IP Settings** on network test screen. The **IP Settings** screen appears.
9. On the top, press ENTER , and then set **IP Mode** to **Manual**.
10. Press the ▼ button on your remote to go to the **IP Address** entry field, and then press ENTER .
11. Enter the first portion of the **IP Address** (for example, 105) into the first entry field using the number keys on your remote. Press the ► button to go to the next field.
12. Enter the next portion of the **IP Address**. Press the right arrow button to go to the next field.

13. Repeat the entry process for each field in the **IP Address**.

 If you make a mistake when entering a number, re-enter the number to correct it. You can also press the ▲ or ▼ button to change the number one unit at a time.

14. When done entering the **IP Address**, press **ENTER** .

15. Press the ▼ button to go to the **Subnet Mask** fields, and then press **ENTER** .

16. Repeat the same entry process for **Subnet Mask**, **Gateway**, and **DNS Server**.





17. When done, select **OK** at the bottom of the page, and then press **ENTER** .

The network test screen appears and the verification process starts. When the connection has been verified, the “Internet connection successful.” message appears.

■ WPS(PBC) Network Setup

How to set up using WPS(PBC)

If your router has a WPS(PBC) button, follow these steps:

1. Go to **Network Settings** screen. (MENU  → **Network** → **Network Settings** → ENTER ).
2. Select the **WPS(PBC)** and press ENTER , then press ENTER  again.
3. Press the **WPS(PBC)** button on your router within 2 minutes. Your TV automatically acquires all the network setting values it needs and connects to your network.
4. The network connection screen appears, and network setup is done.

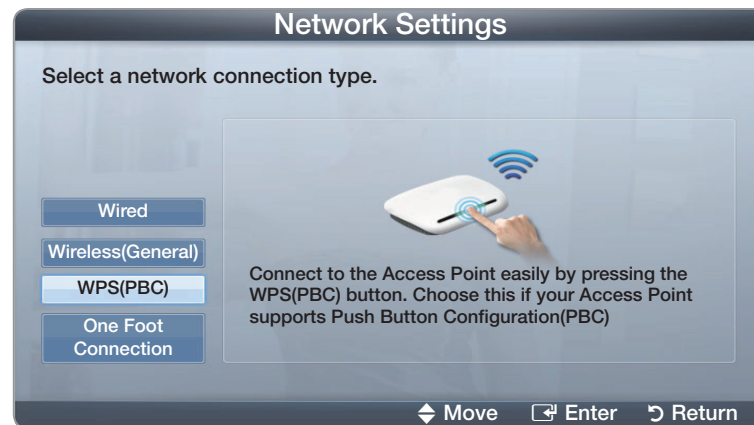

- The displayed image may differ depending on the model.

■ Ad Hoc Network Setup

You can connect to a mobile device that supports Ad-hoc connections - without going through a wireless router - using the “Samsung Wireless LAN adapter”. After you connect the TV to a mobile device, you can use files on the device or connect to the internet using the AllShare or My Contents function.



How to connect to using Ad hoc

1. Go to **Network Settings** screen.

(MENU  → **Network** → **Network Settings** → ENTER ).

2. Select **Wireless (General)**, and press ENTER , then press ENTER  again.

3. Select **Ad hoc**. The message “**Ad hoc service supports a direct connection with Wi-Fi compatible devices like a cell phone or PC. Other network services may be limited when using Ad hoc network device. Do you want to change the network connection?**” is displayed.

4. Select **OK**, and press **ENTER** . The TV searches for the mobile device.
5. When the TV finishes searching for mobile devices, input the generated **Network Name (SSID)** and **Security Key** into the device you want to connect.
 -  If network does not operate normally, check the **Network Name (SSID)** and **Security Key** again. An incorrect Security key may cause a malfunction.
 -  If a device is connected once, it is added to the Network Setting list. When you connect it again, you can find it in the Network Setting list.





■ One Foot Connection Network Setup

The **One Foot Connection** function lets you connect your Samsung TV automatically to a Samsung wireless Router. If your wireless router does not support **One Foot Connection**, you must connect using one of the other methods.

- ☞ You can check for equipment that supports **One Foot Connection** on www.samsung.com.

How to set up using One Foot Connection

Turn on the power of wireless router and TV.

1. Turn on the router and TV.
2. Go to **Network Settings** screen. (MENU  → **Network** → **Network Settings** → ENTER ).
3. Select the **One Foot Connection**, and press ENTER , then press ENTER  again.
4. Place the router in parallel with and no more than 9 3/4 inches from the Samsung Wireless LAN Adapter.



- The displayed image may differ depending on the model.

 If **One Foot Connection** does not connect your TV to your router, a popup window appears on the screen notifying you of the failure. If you want to try using **One Foot Connection** again, reset the wireless router, disconnect the Samsung Wireless LAN adapter and then try again from Step 1.

5. The network test screen appears, and network set up is done.

6. Move the wireless Router to a desired location.

 If the wireless router's settings change or you install a new wireless router, you must perform the **One Foot Connection** procedure again, beginning from Step 1.

■ Plug & Access Network Setup

The **Plug & Access** function lets you easily connect your Samsung TV to your Samsung wireless router by using a USB memory stick to transfer the setup information from the router to the TV. If your non-Samsung wireless router does not support **Plug & Access**, you must connect using one of the other methods.

 You can check for equipment that supports **Plug & Access** on www.samsung.com.

How to set up using Plug & Access function

1. Turn on the Samsung wireless router and your TV.
2. Insert a USB memory stick into the USB port in your Samsung wireless router. Check the router's LED's to make sure it is on (Blinking → On).
3. Take the USB memory stick out of the router, and then insert it into a USB port on your Samsung TV. The memory stick downloads the connection information.
4. Wait until the connection is automatically established.
 - ☒ If **Plug & Access** does not connect your TV to your wireless router, a pop-up window appears on the screen notifying you of the failure. If you want to try using **Plug & Access** a gain, reset the wireless router, disconnect the Samsung Wireless LAN adapter and then try again from Step 1. You can also choose one of the other connection setup methods.

5. The network test screen appears, and the network setup is done.
6. Place the wireless router in a desired location.
 - ☒ If the router's settings change or you install a new wireless router, you must perform the **Plug & Access** procedure again, beginning from Step 1.



Priority QOS

Samsung wireless routers are optimized to stream HD AV to Samsung DTVs.

This Priority QOS function is unique to Samsung wireless routers.

You can connect a Samsung wireless router to many devices, such as laptops, mobile phones, BD players etc. But, when you connect a Samsung TV to a Samsung wireless router, the Samsung wireless router gives the Samsung TV a priority connection.

◀ This ensures you get the highest quality streaming contents and the fastest throughput speed. ▶

- Priority QOS makes your TV faster by giving it priority bandwidth. (Priority QOS is optional. You can turn it on and off.)
- Because your Samsung TV has a priority connection, you can enjoy HD content without buffering.

📝 The connection speed may vary based on the network environment.

If Your TV Fails to Connect to the Internet

Your TV may not be able to connect to the Internet because your ISP has permanently registered the MAC address (a unique identifying number) of your PC or modem, which it then authenticates each time you connect to the Internet as a way of preventing unauthorized access. As your TV has a different MAC address, your ISP can not authenticate its MAC address, and your TV can not connect.

To resolve this problem, ask your ISP about the procedures required to connect devices other than a PC (such as your TV) to the Internet.

If your Internet service provider requires an ID or password to connect to the Internet, your TV may not be able to connect to the Internet. If this is the case, you must enter your ID or password when connecting to the Internet.

The internet connection may fail because of a firewall problem. If this is the case, contact your Internet service provider.

If you cannot connect to the Internet even after you have followed the procedures of your Internet service provider, please contact Samsung Electronics at 1-800-SAMSUNG.

❑ Setting the Time

📖 MENU  → System → Time → ENTER 

■ Time

📖 The current time will appear every time you press the **INFO** button.

- **Clock:** Setting the clock to use the various various timer features of the TV.

📝 If you disconnect the power cord, you have to set the clock again.

- **Clock Mode:** Set the current time manually or automatically.



Auto: Have the TV set the current time automatically using the time from a digital channel.

📝 You must have the cable or an antenna connected to the TV to set the time automatically.

Manual: Set the current time manually.

☞ Depending on the broadcast station and signal, the auto time set up may not be correct. In this case, set the time manually.

– **Clock Set:** Set the **Month**, **Day**, **Year**, **Hour**, **Minute** and **am/pm**.

☞ Select **Clock Set**. Select **Date** or **Time**, and then press **ENTER** . Use the number buttons to enter numbers or press the up and down arrow buttons. Use the left and right arrow buttons to move from one entry field to the next. Press **ENTER**  when done. To exit **Clock Set**, select **Close**, and press **ENTER** .



☞ Available only when **Clock Mode** is set to **Manual**.

☞ You can set the month, day, year, hour, minute and am/pm directly by pressing the number buttons on the remote control.

- **DST (Off / On)**: Switches the DST (Daylight Saving Time) function on or off.
 - ☑ This function is only available when the **Clock Mode** is set to **Auto**.
- **Time Zone**: Select your time zone.
 - ☑ This function is only available when the **Clock Mode** is set to **Auto**.

Using the Sleep Timer

 MENU  → **System** → **Time** → **Sleep Timer** → ENTER 

- **Sleep Timer** : Automatically shuts off the TV after a preset period of time (30, 60, 90, 120, 150 and 180 minutes).
 - ☑ Use the up and down arrows to select a period of time, and then press ENTER . To cancel **Sleep Timer**, select **Off**.

Setting the On / Off Timer

 MENU  → System → Time → ENTER 

- Set **On Timer** so that your TV turns on automatically at a time and on a day of your choosing.
- **On Timer**: You can set up three separate On Timer configurations. (**On Timer 1**, **On Timer 2**, **On Timer 3**)

 You must set the clock before you can use **On Timer**.

Setup: Select **Off**, **Once**, **Everyday**, **Mon~Fri**, **Mon~Sat**, **Sat~Sun** or **Manual**. If you select **Manual**, you can choose the days you want **On Timer** to turn on your TV.

 The  mark indicates days you've selected.



- The displayed image may differ depending on the model.

On Time: Set the hour, minute, am/pm. Use the number buttons or the up and down arrow keys to enter numbers. Use the left and right arrow buttons to change entry fields.

Volume: Set the desired volume level. Use the left and right arrow buttons to change the volume level.

Source: Select **TV** or **USB**. Select TV and the TV will display broadcast or cable TV programs when it turns on automatically. Select USB and the TV will play content from a USB device when the TV turns on automatically. (You can select USB only when a USB device is connected to the TV)

Antenna (when the **Source** is set to **TV**): Select **Air** or **Cable**.

Channel (when the **Source** is set to **TV**): Select the desired channel.

Music / Photo (when the **Source** is set to **USB**): Select a folder in the USB device containing music or photo files you want played when the TV turns on automatically.

NOTE

- If there is no music file on the USB device or you don't select a folder containing a music file, the Timer function does not operate correctly.
- If there is only one photo file in the USB, the Slide Show will not play.
- If a folder name is too long, the folder cannot be selected. Each USB you use is assigned its own folder. When using more than one of the same type of USB, make sure the folders assigned to each USB have different names.
- We recommend that you use a USB memory stick and a multi card reader when using **On Timer**. The **On Timer** function may not work with USB devices with a built-in battery, MP3 players, or PMPs made by some manufacturers because the TV can take too long to recognize these devices.

- **Off Timer:** You can set up three separate Off Timer configurations. (**Off Timer 1**, **Off Timer 2**, **Off Timer 3**)

✎ You must set the clock before you can use **Off Timer**.

Setup: Select **Off**, **Once**, **Everyday**, **Mon~Fri**, **Mon~Sat**, **Sat~Sun** or **Manual**. If you select **Manual**, you can choose the days you want **Off Timer** to turn off your TV.

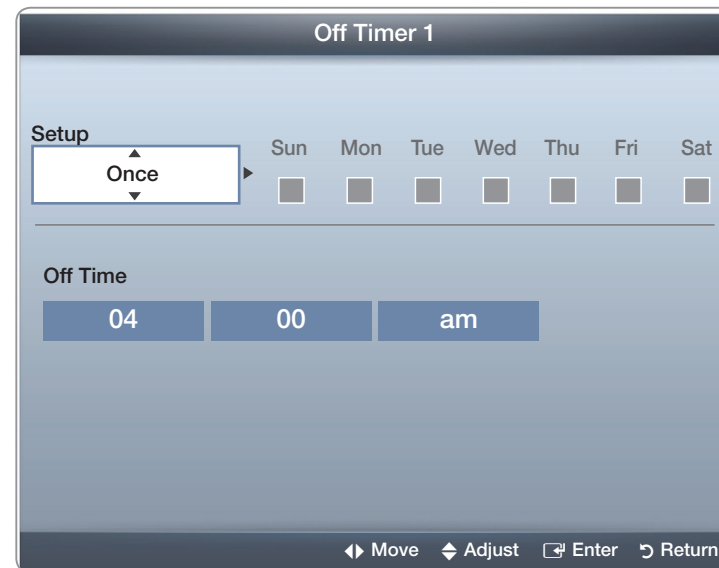

✎ The ✓ mark indicates days you've selected.

Off Time: Set the **hour**, **minute**, and **am/pm**. Use the number buttons or the up and down arrow keys to enter numbers. Use the left and right arrow buttons to change entry fields.



● The displayed image may differ depending on the model.

❑ Blocking Programs

 MENU  → System → Security → ENTER 

■ Security

When you access the Security functions for the first time, the PIN input screen appears. Enter a 4 digit PIN you will remember. The PIN screen closes and the Security Menu appears. Every time you access the Security functions, the PIN screen will appear and you must enter that PIN.

- **Program Rating Lock (Off / On):** When turned on, the **Program Rating Lock** feature can automatically block programs you deem inappropriate for your children. You must enter a PIN (personal identification number) before you can set or change any of the **Program Rating Lock** restrictions.



 The default PIN number for a new TV set is “0-0-0-0”.

TV Rating: You can block TV programs based on their ratings. This function allows you to control what your children can watch. TV Rating displays a grid with locks. The following categories are on the left side:



- **TV-Y:** Young children / **TV-Y7:** Children 7 and over / **TV-G:** General audience / **TV-PG:** Parental guidance / **TV-14:** Viewers 14 and over / **TV-MA:** Mature audience

The following categories are on top:

- **ALL:** Lock all TV ratings. / **FV:** Fantasy violence / **V:** Violence / **S:** Sexual situation / **L:** Adult Language / **D:** Sexually Suggestive Dialog

 To block certain content, you select a lock, and press **ENTER**  (That is, you “click it”). For example, click the lock at the intersection of **V** and **TV-MA**, and you block all programs that are rated violent and for mature adults. The blocks are also assigned to related groups. For example, if you click **TV-Y** under All, then **TV-Y7** will also automatically be blocked.

Similarly, if you click **TV-G** under ALL, then all the categories in the young adult group will be blocked (**TV-G**, **TV-PG**, **TV-14** and **TV-MA**). The sub-ratings (**D**, **L**, **S**, **V**) work similarly. So, if you block the L sub-rating in **TV-PG**, then the **L** sub-ratings in **TV-14** and **TV-MA** will automatically be blocked.

-  To unblock a category, click the lock. To unblock all the categories in a row, click the lock under ALL.
-  To watch a blocked program, you must enter the Security code when requested.

Movie Rating (MPAA): You can block movies based on their MPAA rating. The Motion Picture Association of America (MPAA) has implemented a rating system that provides parents or guardians with advanced information on which films are appropriate for children.

Movie Rating displays a column with locks and the following ratings categories:

- **G**: General audience (no restrictions). / **PG**: Parental guidance suggested. / **PG-13**: Parents strongly cautioned. / **R**: Restricted. Children under 17 should be accompanied by an adult. / **NC-17**: No children under age 17. / **X**: Adults only. / **NR**: Not rated.

- ☑ To block certain content, you select a lock, and press **ENTER**  (That is, you “click it”). For example, click the **X** lock and you block all X-rated movies. The rating categories are also grouped so that clicking one category blocks all the categories a parent would block along with it. For example, if you block the **PG-13** category, then **R**, **NC-17** and **X** will automatically be blocked also.
- ☑ To unblock a category, click the lock.

Canadian English Rating: You can block TV programs based on their Anglophone Canadian rating.

Canadian English Rating displays a column with locks and the following ratings categories:



- **C**: Programming intended for children under age 8. / **C8+**: Programming generally considered acceptable for children 8 years and over to watch on their own. / **G**: General programming, suitable for all audiences. / **PG**: Parental Guidance. / **14+**: Programming contains themes or content which may not be suitable for viewers under the age of 14. / **18+**: Adult programming.

- ☑ To block certain content, you select a lock, and press **ENTER**  (That is, you “click it”). For example, click the 18+ lock and you block all TV programs rated 18+. The rating categories are also grouped so that clicking one category blocks all the categories a parent would block along with it. For example, if you block the **G** category, then **PG**, **14+** and **18+** will automatically be blocked.
- ☑ To unblock a category, click the lock.

Canadian French Rating: You can block TV programs based on their French Canadian rating.

Canadian French Rating displays a column with locks and the following ratings categories:

- **G:** General / **8 ans+:** Programming generally considered acceptable for children 8 years and over to watch on their own. / **13 ans+:** Programming may not be suitable for children under the age of 13. / **16 ans+:** Programming is not suitable for children under the age of 16. / **18 ans+:** Programming restricted to adults.

 To block certain content, you select a lock, and press **ENTER**  (That is, you “click it”). For example, click the 18 ans+ lock and you block all TV programs rated 18 ans+. The rating categories are also grouped so that clicking one category blocks all the categories a parent would block along with it. For example, if you block the **8 ans+** category, then **13 ans+**, **16 ans+** and **18 ans+** will automatically be blocked also.

 To unblock a category, click the lock.

Downloadable U.S. Rating: Parental restriction information you can use while watching DTV channels.

NOTE

- If information is not downloaded from the broadcasting station, **Downloadable U.S. Rating** menu is deactivated.
- Parental restriction information is automatically downloaded while you watch DTV channels. It may take several seconds.
- The **Downloadable U.S. Rating** menu is available for use after information is downloaded from the broadcasting station. However, depending on the information from the broadcasting station, it may not be available for use.
- Parental restriction levels differ depending on the broadcasting station. The default menu name and **Downloadable U.S. Rating** change depending on the downloaded information.

- Even if you set the on-screen display to another language, the **Downloadable U.S. Rating** menu will appear in English only.
- Blocking one rating level will automatically block other categories that deal with more sensitive material.
- The rating titles (For example: Humor Level..etc) and TV ratings (For example: DH, MH, H..etc) may differ depending on the broadcasting station.



- **Change PIN:** The **Change PIN** screen will appear. Choose any 4 digits for your PIN and enter it in **Enter New PIN**. Re-enter the same 4 digits. in **Confirm New PIN**. When the Confirm screen disappears, press the OK button. The TV has memorized your new PIN.

How to watch a restricted program or movie

If the TV is tuned to a restricted program or movie, the **Program Rating Lock** will block it. The screen will go blank and the following message will appear:

◀ This channel is blocked by **Program Rating Lock**. Please enter the PIN to unblock
Enter the PIN to unblock. the program or movie. ▶

- 📝 If you forget the PIN, press the remote-control buttons in the following sequence, which resets the PIN to “0-0-0-0:” **POWER** (off) → **MUTE** → **8** → **2** → **4** → **POWER** (on)

❏ Economical Solutions

■ Eco Solution

👆 MENU  → System → Eco Solution → ENTER 

- **Energy Saving (Off / Low / Medium / High / Picture Off)**: Lets you adjust the brightness of the TV in order to reduce power consumption. If you select **Picture Off**, the screen is turned off, but the sound remains on. Press any button except the volume button to turn on the screen.
- ◀ • **Eco Sensor (Off / On)**: To enhance your power savings, the picture settings will automatically adapt to the light in the room. ▶
- 📝 If you adjust **Cell Light** in the **Picture** menu, the **Eco Sensor** will be set to **Off**.

Min Cell Light: When **Eco sensor** is **On**, you can manually adjust the minimum screen brightness.

 If **Eco Sensor** is **On**, the display brightness may change (become slightly darker or brighter) depending on the surrounding light intensity. You can control the screen's minimum brightness with the **Min Cell Light** function.

- **No Signal Power Off (Off / 15 min. / 30 min. / 60 min.):** To avoid unnecessary energy consumption, you can set how long you want the TV to remain on if it's not receiving a signal.

 Disabled when an attached PC is in power saving mode.

- **Auto Power Off (Off / On):** The TV will automatically turn off if you don't press a button on the remote or touch a button on TV's front panel within 4 hours to prevent overheating.

❑ Picture In Picture (PIP)

 MENU  → System → PIP → ENTER 

■ PIP







You can watch a program whose signal has passed through the TV's tuner and the video from one external video source simultaneously. For example, if you have a cable box connected to the Cable In jack, you can use **PIP** to watch programs from the cable box and a movie from a Blu-ray player attached to the HDMI In jack.

NOTE

- For PIP sound, refer to the **Sound Select** instructions.
- The **PIP** function is not available in **3D** mode.
- If you turn the TV off while watching in the PIP mode, the PIP function is reset to off. When you turn your TV on, you must turn PIP on again to watch in the PIP mode.
- You may notice that the picture in the PIP window becomes slightly unnatural when you use the main screen to view a game or karaoke.
- While **Program Rating Lock** is on, you cannot use PIP.
- PIP Settings

The picture from the external video source will be in the main screen and the picture from the TV's tuner will be in the PIP sub-picture window.

Main picture	Sub picture
Component, HDMI, PC	TV



- **PIP (Off / On)**: Activate or deactivate the PIP function.
- **Air/Cable (Air / Cable)**: Select either **Air** or **Cable** as the input source for the sub-screen.
- **Channel**: Select the channel for the sub-screen.
- **Size** ( / ): Select a size for the subpicture.
- **Position** ( /  /  / ): Select a position for the sub-picture.
- **Sound Select (Main / Sub)**: You can choose to listen to the sound from the Main picture or the Sub picture.

❑ Other Features

 MENU  → **System** → ENTER 

■ Menu Language

Set the menu language.

1. Select **Menu Language**, and then press the ENTER  button.
 2. Choose a language, and then press the ENTER  button.
-  Choose from **English**, **Español**, and **Français**.

■ Caption

(On-Screen Text Messages)

- **Caption (Off / On):** You can switch the caption function on or off. If captions are not available, they will not be displayed on the screen.

☒ The Caption feature does not work with devices connected to the TV through the Component, HDMI or PC input jacks.

- **Caption Mode:** You can select the desired caption mode.

☒ The availability of captions depends on the program being broadcast.

Default / CC1 ~CC4 / Text1 ~Text4: (analog channels only) The Analog Caption function operates in either analog TV channel mode or when a signal is supplied from an external device to the TV. (Depending on the broadcasting signal, the Analog Caption function may or may not work with digital channels.)

Default / Service1 ~Service6 / CC1 ~CC4 / Text1 ~Text4: (digital channels only) The Digital Captions function works with digital channels.

 **Service1 ~6** may not be available in digital caption mode depending on the broadcast.

- **Digital Caption Options:** (digital channels only) Adjusts the each option. When done, select **Close**.

Size: Options include Default, Small, Standard and Large. The default is Standard.

Font Style: Options include Default and Styles 0 to 7. The default is Style 0.

Foreground Color: You can change the color of the letters. Options include Default, White, Black, Red, Green, Blue, Yellow, Magenta and Cyan. The default is White.

Background Color: You can change the background color of the caption. Options include Default, White, Black, Red, Green, Blue, Yellow, Magenta and Cyan. The default is Black.

Foreground Opacity: This adjusts the opacity of text. Options include Default, Transparent, Translucent, Solid and Flashing.

Background Opacity: This adjusts the opacity of the caption background. Options include Default, Transparent, Translucent, Solid and Flashing.

Return to Default: This option sets each Size, Font Style, Foreground Color, Background Color, Foreground Opacity and Background Opacity to its default.

NOTE

- **Digital Caption Options** are available only when you can select **Default** and **Service1 ~ Service6** in **Caption Mode**.
- The availability of captions depends on the program being broadcast.
- The **Default** setting follows the standards set by the broadcaster.
- You cannot set the Foreground and Background to the same color.
- You cannot set both the **Foreground Opacity** and the **Background Opacity** to **Transparent**.

■ **Screen Burn Protection**

To reduce the possibility of screen burn, this unit is equipped with Pixel Shift screen burn prevention technology. Pixel Shift moves the picture slightly on the screen. The Time function setting allows you to program the time between movement of the picture in minutes.



Your TV also has the following additional screen burn protection functions:

- **Pixel Shift**
- **Auto Protection Time**
- **Scrolling**
- **Side Gray**

- **Pixel Shift (Off / On)**: Using this function, you can set the TV to move pixels minutely on the PDP screen in a horizontal or vertical direction to minimize after images on the screen.

 Available Pixel Shift Settings and Optimum Settings

	Available Settings	Optimum Settings for TV/AV/ Component/HDMI/PC
Horizontal	0~4(pixels)	4
Vertical	0~4(pixels)	4
Time (minute)	1~4 min	4 min

-  The **Pixel Shift** value may differ depending on the monitor size (inches) and mode.
-  This function is not available in the **Screen Fit** mode.

- **Auto Protection Time (Off / 10 min. / 20 min. / 40 min. / 1 hour)**: If the screen displays a still image for a certain period of time you define, the TV activates the screen saver to prevent the formation of burnt in ghost images on the screen.
- **Scrolling**: This function removes after-images on the screen by illuminating all the pixels on the PDP according to a pattern. Use this function when there are after images or symbols on the screen, especially when you displayed a still image on the screen for a long time.
 - ☞ The after-image removal function has to be executed for a long time (approximately 1 hour) to effectively remove after-images on the screen. If the after-image is not removed after you apply the function, repeat the function again.
 - ☞ Press any key on the remote control to cancel this feature.
- **Side Gray (Light / Dark)**: When you watch TV with the screen ratio set to 4:3, using the Side Gray function can prevent damage to the edges of the screen by adjusting the white balance on the extreme left and right sides.

■ General

- **Game Mode (Off / On)**: When you have connected a game console such as a PlayStation™ or Xbox™ to the TV, you can enjoy a more realistic gaming experience if you set Game Mode on.

📝 Precautions and limitations for Game Mode

- Before disconnecting a game console and connecting another external device, set **Game Mode** to **Off** in the System menu.
- If you display the TV menu in **Game Mode**, the screen shakes slightly.

- ✎ **Game Mode** is not available when the input source is set to TV or PC.
- ✎ Set **Game Mode** to **On** only after connecting a game console. If you turn Game Mode on before you have attached the game console, you may notice reduced picture quality.
- ✎ If **Game Mode** is **On**:
 - **Picture Mode** is set to **Standard** and **Sound Mode** is set to **Movie**.



- **Menu Transparency (Bright / Dark)**: Set the Transparency of the menu.
 - **Boot Logo (Off / On)**: Displays the Samsung logo when the TV is turned on.
 - **TV Name** **for PDP 550 Series and above**: Sets the TV name so you can find it easily on a mobile device.
-  If you select User Input, you can type on the TV using the OSK (On Screen Keyboard).

■ Anynet+ (HDMI-CEC)

For details on set up options, refer to the “Anynet+ (HDMI-CEC)” instructions.



■ DivX® Video On Demand

Shows the registration code authorized for the TV. If you connect to the DivX web site and register using that code, you can download the VOD registration file. If you activate the VOD registration using My Contents, the registration is completed.

 For more information about DivX® VOD, visit “<http://vod.divx.com>”.



■ **Network Remote Control (On / Off)** for PDP 550 Series and above

Turn on/off or give permission to Samsung mobile phone devices to connect with and control the TV.

You must have a Samsung Mobile phone/device which supports Network Remote Control. For more details, refer to each device's manual.



❑ Support Menu

 MENU  → Support → ENTER 

■ e-Manual

The e-Manual is built into your TV. Open the e-Manual to learn how to use your TV's many features.

 For the detailed information about the e-Manual Screen, refer to “How to view the e-Manual” in the Users Manual.

■ Self Diagnosis

- **Picture Test:** Use to check for picture problems. **Picture Test** displays a high definition picture that you can examine for flaws or faults.

Yes: Select **Yes** if the test picture does not appear or there is noise or distortion in the test picture. There may be a problem with the TV. Contact Samsung's Call Center for assistance.

No: Select **No** if the test picture displays properly. There may be a problem with your external equipment. Please check your connections. If the problem persists, refer to the external device's user manual.

- **Sound Test:** Use the built-in melody to check for sound problems.
 - ☞ If you hear no sound from the TV's speakers, before performing the sound test, make sure **Speaker Select** is set to **TV Speaker** in the **Sound** menu, and then try the speakers again.
 - ☞ You will hear the melody during the test even if you have set **Speaker Select** to **External Speaker** or have muted the sound by pressing the **MUTE** button.

Yes: Select **Yes** if you can hear sound from only one speaker or from neither speaker during the sound test. There may be a problem with the TV. Contact Samsung's Call Center for assistance.

No: Select **No** if you can hear sound from the speakers. There may be a problem with your external equipment. Please check your connections. If the problem persists, refer to the external device's user manual.

- **Signal Information:** (digital channels only) The reception quality of over-the-air HD channels is either perfect or the channels are unavailable. Signal Information displays HD channel signal strength so you can adjust your antenna to increase signal strength and receive HD channels.
- **Troubleshooting:** Displays a troubleshooting guide organized into four symptom categories: Poor or Distorted Picture, Distorted Sound or No Sound, RF or PC Issues, and Other Issues. If your TV seems to be having a problem, access the troubleshooting guide for a solution.



■ Software Upgrade

The **Software Upgrade** menu lets you upgrade your TV's software to the latest version.

Current Version: This is the software version already installed in the TV.

- 📝 The current version is displayed in the following format: **Year / Month / Day_**
Version number.

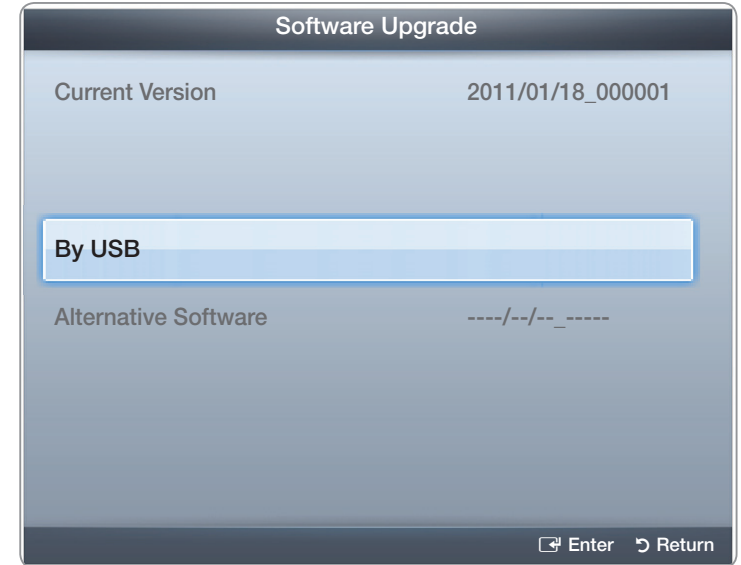

- The displayed image may differ depending on the model.

Upgrading to the Latest Version

You can upgrade in three ways:

- **By USB**
- **By Online**
- **By Standby Mode Upgrade**

The three methods are explained in the following pages.

- ◀  Be careful not to turn off the power until the upgrade is complete. The TV will turn off and on automatically after completing the firm ware upgrade. When you upgrade software, all video and audio settings you have made will return to their default settings. We advise you to write down your settings so that you can easily reset them after the upgrade. ▶

By USB

To upgrade by USB, follow these steps:

1. Visit www.samsung.com.
 2. Download the latest USB software upgrade exe archive to your computer.
 3. Extracts the exe archive to your computer.
You should have a single folder with the same name as the exe file.
 4. Copy the folder to a USB flash drive.
 5. Turn on the TV, and then insert the USB flash drive into the USB port of the TV.
 6. In the TV's menu, go to **Support** → **Software Upgrade**.
 7. Select **By USB**.
-  Please be careful not to remove the USB drive until the upgrade is complete.

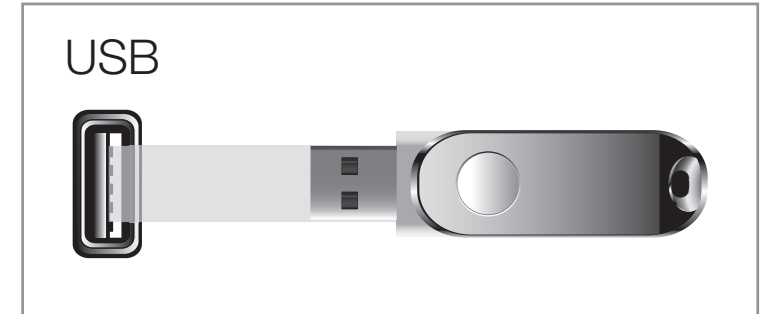

- The displayed image may differ depending on the model.

By Online for PDP 550 Series and above

The **By Online** function lets you download the upgrade software directly from the Internet into your TV and then upgrade the software in one operation. To use **By Online**, you must have configured your TV to connect to your network and the TV must be connected to the Internet. See the Network Connection instructions.

To upgrade by Online, follow these steps:

1. Select **By Online**, and then press the **ENTER**  button. The Connecting to Server message appears.
2. If there is a download available, the Download pop-up appears with a progress bar and the download starts.

3. When the download is complete, the Upgrade Query window appears with three choices: **Upgrade Now**, **Upgrade Later**, or **Don't Upgrade**.
4. If you select **Upgrade Now**, the TV upgrades the software, turns off, and then turns on automatically.
5. If you do not make a selection in one minute or select **Upgrade Later**, the TV stores the new upgrade software. You can upgrade the software later using the **Alternative Software** function.
6. If you select **Don't Upgrade**, the TV cancels the upgrade.

Alternative Software for PDP 550 Series and above

The **Alternative Software** option lets you upgrade using a file the TV downloaded earlier, but you decided not to install immediately, or a file downloaded by the TV in Standby Mode (See **Standby Mode Upgrade** on the next page).

To upgrade by **Alternative Software**, follow these steps:

1. If upgrade software has been downloaded, you will see the software version number to the right of **Alternative Software**.
2. Select **Alternative Software**, and then press the **ENTER**  button.
3. The TV displays a message asking if you want to upgrade. Select **Yes**. The TV begins the upgrade.
4. When the update is complete, the TV turns off automatically, and then turns on.

Standby Mode Upgrade for PDP 550 Series and above

You can set the **Standby Mode Upgrade** function so that the TV downloads new upgrade software when it is in Standby mode. In Standby mode, the TV is off, but its Internet connection is active. This allows the TV to download upgrade software automatically, when you are not using it. Because the TV is turned on internally, the screen may glow slightly. This phenomenon may continue for more than 1 hour until the software download is complete.

To set **Standby Mode Upgrade**, follow these steps:

1. Press the arrow buttons to select **Upgrade** in Standby Mode, and then press the **ENTER**  button.

2. Select **On** or **Off**.

- **Off** : If you select **Off**, the TV will notify you with a pop up message when new upgrade software is available.
 - **On** : If you select **On**, the TV will automatically download new upgrade software when it is in Standby mode with the power off. If it downloads new upgrade software, the TV will ask you if you want to install it when you turn the TV on.
-  To use the **Standby Mode Upgrade** function, your TV must be connected to the Internet.

■ **Contact Samsung**

View this information when your TV does not work properly or when you want to upgrade the software. You can find information regarding our call centers and how to download products and software.



3D

 MENU  → Picture → 3D → ENTER 

■ Using the 3D function

This exciting new feature enables you to view 3D content. To fully enjoy this feature, you must purchase a pair of Samsung 3D Active Glasses to view 3D video. Samsung 3D Active Glasses are sold separately. For more detailed purchasing information, contact the retailer where you purchased this TV.

IMPORTANT HEALTH AND SAFETY INFORMATION FOR 3D PICTURES.



Read and understand the following safety information before using the TV's 3D function.

WARNING

- Some viewers may experience discomfort while viewing 3D TV such as dizziness, nausea and headaches. If you experience any such symptom, stop viewing 3D TV, remove the 3D Active Glasses and rest.
- Watching 3D images for an extended period of time may cause eye strain. If you feel eye strain, stop viewing 3D TV, remove your 3D Active Glasses and rest.

- A responsible adult should frequently check on children who are using the 3D function. If there are any reports of tired eyes, headaches, dizziness, or nausea, have the child stop viewing 3D TV and rest.
- Do not use the 3D Active Glasses for other purposes (such as general eyeglasses, sunglasses, protective goggles, etc.)
- Do not use the 3D function or 3D Active Glasses while walking or moving about. If you use the 3D function or 3D Active Glasses while walking or moving about you can injure yourself by running into objects, tripping, and/or falling.

- **3D Mode:** Select the 3D input format.
 - ☑ If you want to experience the 3D effect fully, put the 3D Active Glasses on first, and then select the **3D Mode** from the list below that provides the best 3D viewing experience.

3D Mode		Operation
Off		Turns the 3D function off.
	2D → 3D	Changes a 2D image to 3D.
	Side by Side	Displays two images next to each other.
	Top & Bottom	Displays one image above another.

- ☑ Some file formats may not be supported “2D → 3D.”
- ☑ “Side by Side” and “Top & Bottom” are available when the resolution is 720p, 1080i and 1080p in DTV, HDMI and USB mode or when you set the TV’s source to PC and your PC is connected through an HDMI/DVI cable.

- **3D Perspective (-5 ~ +5)**: Adjust the overall 3D perspective of on-screen image.
- **Depth (1~10)**: Adjust overall depth.
- **L/R Change (L/R Image / R/L Image)**: Swaps the left and right pictures.
- **3D → 2D (Off / On)**: Displays the image for the left eye only.
 - ☞ This function is deactivated when **3D Mode** set to “2D → 3D” or Off.



 Support resolution (16:9 only)

Resolution	Frequency (Hz)
1280 x 720p	50 / 60 Hz
1920 x 1080i	50 / 60 Hz.
1920 x 1080p	24 / 30 / 50 / 60 Hz

Resolution supported for HDMI PC mode

The optimal resolution for the HDMI PC mode is 1920 x 1080. If the input resolution is not 1920 x 1080, the TV may not display images properly in 3D display or full screen mode.

How to watch the 3D images

- ☞ Some 3D modes may not be available depending on the format of the image source.
 - ☞ To watch in 3D, you must wear 3D Active Glasses and turn the glasses on by pressing the power button.
1. Press the **MENU** button on your remote, use the ▲ or ▼ button to select **Picture**, and then press the **ENTER**  button.
 2. Use the ▲ or ▼ button to select **3D**, and then press the **ENTER**  button.

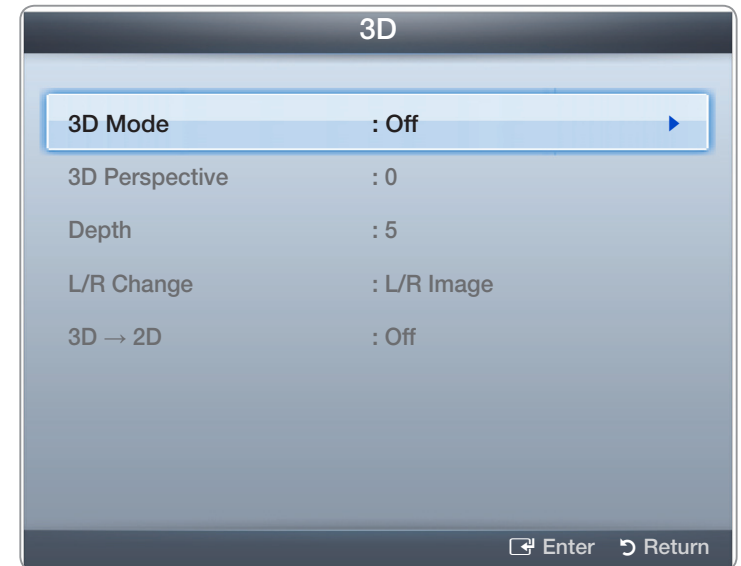

- The displayed image may differ depending on the model.

3. Use the ▲ or ▼ button to select **3D Mode**, and then press the ENTER ↵ button.
4. Using the ◀ or ▶ buttons on your remote control, select the **3D Mode** of the image you want to view.

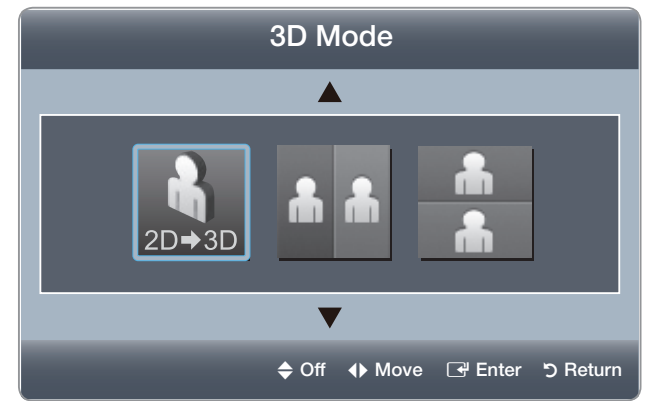

- The displayed image may differ depending on the model.

Supported formats and operating specifications for Standard HDMI 3D

-  The 3D formats listed below are recommended by the HDMI association and must be supported by 3D TVs.

Source signal format	Standard HDMI 1.4 3D
1920x1080p@24Hz x 2	1920x2205p@24Hz
1280x720p@60Hz x 2	1280x1470p@60Hz

Read These Notes Before Using the 3D Function...

NOTE

- **3D Mode** is set to **Off** automatically when you access **My Contents** or **e-Manual** functions.
- **3D Mode** is set to its memorized configuration value automatically when you change the input source.
- Some **Picture** functions are disabled in **3D** mode.
- **PIP** is not supported in **3D** mode.

- 3D Active Glasses from Samsung's previous product (IR type) or other manufacturers are not supported.
- When the TV is initially powered on, it may take some time until the 3D display is optimized.
- The 3D Active Glasses may not work properly if there are any other 3D product or electronic devices turned on near the glasses or TV. If there is a problem, keep other electronic devices as far away as possible from the 3D Active Glasses.

- Be sure to stay within the optimum viewing angle and TV viewing distance when watching 3D pictures. Otherwise, you may not be able to see 3D effects properly.
- The ideal 3D viewing distance is three times or more the height of the screen. For example, if your screen is two feet high, you should sit at least six feet from the screen. We recommend sitting so that your eyes are level with the screen.



AllShare™

for PDP 550 Series and above

AllShare™ connects your TV and compatible Samsung mobile phones/ devices through a network. You can play media contents including videos, photos, and music saved on your mobile phones or the other devices (such as your PC) by controlling them on the TV via the network.

-  For more information, visit “www.samsung.com” or contact the Samsung call center. Mobile devices may need additional software installation. For details, refer to each device’s user’s guide.

- ☞ If your Samsung TV connects to a non-Samsung DLNA server, a compatibility issue may occur during video playback.
- ☞ By connecting your Samsung TV to a network via AllShare™, you can use Samsung's original functions as follows:
 - Playback of various video formats (DivX, MP4, 3GPP, AVI, ASF, MKV, etc.)
 - Video thumbnail feature
 - Bookmark function (to resume video playback)
 - Auto-chaptering (scene navigation)
 - Digital content management
 - Compatibility with various subtitle formats (SRT, SMI, SUB, TXT, TTXT)
 - Search with file names
 - And many others
- ☞ To use the original DLNA functions of Samsung fully, it is recommended that you use the AllShare™ software provided with your TV.

❑ Setting Up AllShare™ for PDP 550 Series and above

🖱️ MENU  → Network → AllShare Settings → ENTER 

■ AllShare Settings

- **Media (On / Off)**: Enables or disables the media function. When the media function is on, you can control Media contents play using mobile phones or other devices that support DLNA DMC.

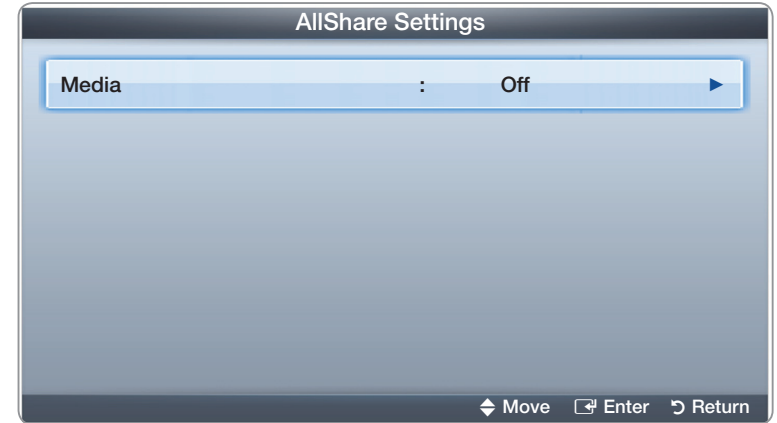

- The displayed image may differ depending on the model.

■ Media

Shows a list of mobile phones or connected devices which have been set up to use the **Media** function with this TV.

☑ The Media function is available in all devices which support DLNA DMC.

- **Allowed / Denied:** Allows/Blocks the devices.

- **Delete:** Deletes the devices from the list.



☑ This function only deletes the name of the device from the list. If the deleted device is turned on or tries to connect to the TV, it may appear on the list again.

Using the Media Function

An alarm window appears informing you that media contents (videos, photos, music) sent from a mobile phone will be displayed on your TV. The contents are played automatically 3 seconds after the alarm window appears. If you press the **RETURN** or **EXIT** button when the alarm window appears, the media contents are not played.

NOTE

- The first time a device accesses your TV through the media function, a warning popup window appears. Press the **ENTER**  button to select **Allow**. This permits the phone to access the TV freely and use the Media function to play content.

- To turn off media contents transmissions from a mobile phone, set **Media** to **Off** in the **AllShare Settings**.
- Contents may not play on your TV depending on their resolution and format.
- The **ENTER**  and  /  buttons may not work depending on the type of media content.
- Using the mobile device, you can control the media play. For details, refer to each mobile's user's guide.



❑ Anynet+(HDMI-CEC)

■ What is Anynet+? TOOLS

Anynet+ is a function that enables you to control all connected Samsung devices that support Anynet+ with your Samsung TV's remote. The Anynet+ system can be used only with Samsung devices that have the Anynet+ feature. To be sure your Samsung device has this feature, check if there is an Anynet+ logo on it.

NOTE



- You can only control Anynet+ devices using the TV's remote control, not the buttons on the TV.
- The TV remote control may not work under certain conditions. If this occurs, reselect the Anynet+ device.
- The Anynet+ functions do not operate with other manufacturers' products.

- For instructions explaining how to connect Anynet+ external devices, refer to the device's user manual.
- You must connect an Anynet+ device using an HDMI cable. Some HDMI cables may not support Anynet+ functions.
- Anynet+ works when the AV device supporting Anynet+ is in the standby or on status.
- Anynet+ supports up to 12 AV devices in total. Note that you can connect up to 3 devices of the same type.
- However, you can connect only one Anynet+ Home Theater. To connect an Anynet+ Home Theater, connect the Home Theater to the TV using an HDMI cable then:

- To hear sound from the Home Theater's Front, Left and Right speakers and the subwoofer only, connect a Digital Optical cable between the **DIGITAL AUDIO OUT (OPTICAL)** jack on your TV and the Digital Audio Input on the Home Theater.
- To hear 5.1 channel audio, connect HDMI cables to your Anynet+ DVD player, satellite box, etc. Then, connect the **DIGITAL AUDIO OUT (OPTICAL)** jack on your DVD player, Satellite Box, etc. (i.e. Anynet + Device 1 or 2) directly to the Home Theater, not the TV.

Anynet+ Menu

The Anynet+ menu changes depending on the type and status of the Anynet+ devices connected to the TV.

Anynet+ Menu	Description
View TV	Changes Anynet+ mode to TV broadcast mode.
Device List	Shows the Anynet+ device list.
(device_name) MENU	Shows the connected device menus. E.g. if a DVD player recorder is connected, the disc menu of the DVD player recorder will appear.
(device_name) Tools	Shows the tools menu of the connected device. E.g. if a DVD player recorder is connected, the play menu of the DVD player recorder will appear.  Depending on the device, this menu may not be available.
(device_name) Title Menu	Shows the title menu of the connected device. E.g. If a DVD player recorder is connected, the title menu of the title menu of the movie in the DVD player recorder will appear.  Depending on the device, this menu may not be available.
Receiver	Sound is played through the receiver.

□ Setting Up Anynet+

 MENU  → System → Anynet+ (HDMI-CEC) → ENTER 

■ Anynet+ (HDMI-CEC) (Off / On)

To use the Anynet+ Function, you must set **Anynet+ (HDMI-CEC)** to **On**.

 When the **Anynet+ (HDMI-CEC)** function is disabled, all the Anynet+ related operations are deactivated.



◀ ■ Auto Turn Off (No / Yes) ▶

Set an Anynet+ Device to turn off automatically when the TV is turned off.

 If **Auto Turn Off** is set to **Yes**, running external devices will turn off at the same time as the TV turns off.

 **Auto Turn Off** may not be enabled depending on the device.

❑ Switching between Anynet+ Devices

1. Press the **TOOLS** button, select **Anynet+ (HDMI-CEC)**, and then press **ENTER**.
2. Select Device List, and then press the **ENTER**  button.
 - ✎ If you cannot find a device you want, press the **A** button to refresh the list.
3. Select a device, and then press the **ENTER**  button. You can switch to the selected device.

◀  The **Device List** menu appears only when you set **Anynet+ (HDMI-CEC)** to **On** in the **System** menu. ▶

- Switching to the selected device may take up to 2 minutes. You cannot cancel the operation during the switching operation.
- If you have selected an Anynet+ device by pressing the **SOURCE** button and then selecting its input source, you cannot use the Anynet+ function. Make sure to switch to an Anynet+ device by using the **Device List**.

❑ Listening through a Receiver

You can listen to sound through a receiver (i.e Home Theater) instead of the **TV Speaker**.

1. Select **Receiver** and set to **On**.

2. Press the **EXIT** button to exit.

- ☞ If your receiver supports audio only, it may not appear in the device list.
- ☞ The receiver will work when you have properly connected the optical in jack of the receiver to the **DIGITAL AUDIO OUT (OPTICAL)** jack of the TV.
- ☞ When the receiver (i.e Home Theater) is set to On, you can hear sound output from the TV's Optical jack. When the TV is displaying a DTV (air) signal, the TV will send out 5.1 channel sound to the receiver. When the source is a digital component such as a DVD player and is connected to the TV via HDMI, you will hear only 2 channel sound from the receiver.

❑ Troubleshooting for Anynet+

Problem	Possible Solution
Anynet+ does not work.	<ul style="list-style-type: none">● Check if the device is an Anynet+ device. The Anynet+ system supports Anynet+ devices only.● You can connect only one receiver (home theater).● Check if the Anynet+ device power cord is properly connected.● Check the Anynet+ device's Video/Audio/HDMI cable connections.● Check whether Anynet+ (HDMI-CEC) is set to On in the Anynet+ setup menu.● Check whether the TV remote control is in TV mode.● Check whether the remote control is Anynet+ compatible.● Anynet+ doesn't work in certain situations. (Searching channels, operating My Contents or Plug & Play (initial setup), etc.)● If you have removed and the reconnected the HDMI cable, please make sure to search devices again or turn your TV off and on again.● Check if the Anynet+ Function of the Anynet+ device is set on.

I want to start Anynet+.	<ul style="list-style-type: none">● Check if the Anynet+ device is properly connected to the TV and check if the Anynet+ (HDMI-CEC) is set to On in the Anynet+ Setup menu.● Press the TOOLS button to display the Anynet+ menu and select a menu you want.
I want to exit Anynet+.	<ul style="list-style-type: none">● Select View TV in the Anynet+ menu.● Press the SOURCE button on the TV remote control and select a non- Anynet+ device.
The message “Connecting to Anynet+ device...” appears on the screen.	<ul style="list-style-type: none">● You cannot use the remote control when you are configuring Anynet+ or switching to a view mode.● Use the remote control after the TV has completed Anynet+ configuration or has finished switching to Anynet+.
The Anynet+ device does not play.	<ul style="list-style-type: none">● You cannot use the play function when Plug & Play (initial setup) is in progress.

The connected device is not displayed.

- Check whether or not the device supports Anynet+ functions.
- Check whether or not the HDMI cable is properly connected.
- Check whether **Anynet+ (HDMI-CEC)** is set to **On** in the Anynet+ setup menu.
- Search Anynet+ devices again.
- Anynet+ requires an HDMI connection. Make sure the device is connected to your TV with an HDMI cable.
- Some HDMI cables may not support Anynet+ functions.
- If the connection is terminated because there has been a power failure or the HDMI cable has been disconnected, please repeat the device scan.

The TV sound is not output through the receiver.

- Connect the optical cable between TV and the receiver.

❑ Using the My Contents

Enjoy photos, music and/or movie files saved on a USB Mass Storage Class (MSC) device and/or your PC.

1. Press the **CONTENT** button.
 2. Press the ▲ / ▼ / ◀ / ▶ button to select the **Videos**, **Photos**, or **Music**, and then press the **ENTER** ↵ button.
- 📝 To view content on a USB device, you must plug the device into a USB jack on the TV.



- The displayed image may differ depending on the model.

❑ Connecting a USB Device

1. Turn on your TV.
2. Connect a USB device containing photo, music and/or movie files to the **USB** jack on the side of the TV.
3. When a USB device is connected to the TV, the **Connected Device** window appears. Select a connected device, and then press **ENTER** .

The TV may display the files on the USB device automatically if it is the only device connected.

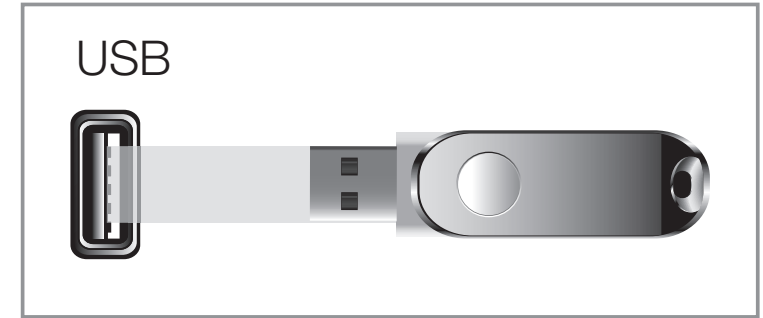

- The displayed image may differ depending on the model.

✎ The USB function might not work properly with unlicensed multimedia files.

✎ Read this information before using **My Contents** with a USB device:

- MTP (Media Transfer Protocol) is not supported.
- The file system supports FAT16, FAT32 and NTFS.
- Certain types of USB Digital camera and audio devices may not be compatible with this TV.
- **My Contents** is compatible with the Sequential jpeg format only. It is not compatible with the Progressive jpeg format.
- **My Contents** only supports USB Mass Storage Class (MSC) devices. **for PDP 550 Series and above** MSC is a Mass Storage Class Bulk-Only Transport device. Examples of MSC are Thumb drives, Flash Card Readers and USB HDD (USB HUB are not supported). Devices should be connected directly to the TV's USB port.
- USB(HDD) is not supported. **for PDP 450 and 490 Series**

- Connect USB HDDs to the dedicated port, **USB 1 (HDD)**, only.
- Before connecting your device to the TV, please back up your files to prevent them from damage or loss of data. SAMSUNG is not responsible for any data file damage or data loss.
- Do not disconnect the USB device while it is loading.
- The higher the resolution of the image, the longer it takes to display on the screen.
- The maximum supported JPEG resolution is 15360 X 8640 pixels.

- If a file is corrupted or the TV does not support the file type, the “Not Supported File Format” message appears.
- If the files are sorted by Folder View, the TV can display the names of up to 1000 files in each folder.
- If the number of files and folders saved on a USB storage device is approximately over 4000, the files and folders may not appear and some folders may not be opened.
- The TV cannot play MP3 files with DRM that have been downloaded from a for-pay site. Digital Rights Management (DRM) is a technology that supports the creation, distribution, and management of digital content in an integrated and comprehensive way, including protecting the rights and interests of content providers, preventing illegal copying of contents, and managing billings and settlements.

- If more than 2 PTP devices are connected, you can only use one at a time.
- If more than two MSC devices are connected, some of them may not be recognized. A USB device that requires high power (more than 500mA or 5V) may not be supported.
- If an over-power warning message is displayed while you are connecting or using a USB device, the device may not be recognized or may malfunction.
- If the TV has no input during the time set in **Auto Protection Time**, the Screensaver will run.
- The power-saving mode of some external hard disk drives may be released automatically when you connect them to the TV.



- If you use a USB extension cable, the TV may not recognize the USB device or may not be able to read the files on the device.
- If a USB device you connect to the TV is not recognized, the files on the device are corrupted, or a file in the list is not played, connect the USB device to a PC, format the device and check the connection.
- If a file you deleted from the PC is still found when you run **My Contents**, use the “Empty the Recycle Bin” function on the PC to permanently delete the file.



❑ **Connecting to a PC through your network** for PDP 550 Series and above

You can play pictures, music, and videos saved in your PC through a network connection using the **AllShare** mode.

- ✍ For more information on how to configure your TV and connect it to your network, see 'Network Connection'.
- ✍ To view content located on your PC, you must have connected your TV and your PC to your LAN and downloaded and installed AllShare PC Software on your PC.
- ✍ We recommend you locate both your TV and PC in the same network subnet. IP addresses have four parts, separated by periods (111.222.333.444). If your TV and PC are in the same subnet, the first 3 parts of the TV IP address and the PC IP address (111.222.333) will be the same and only the last part (the host address) will be different.

- ✎ The following My Contents functions are not supported when you are playing media from a PC connected through a network:
 - The **Background Music** and **Background Music Setting** functions.
 - Sorting files by preference in the **Photos**, **Music**, and **Videos** folders.
 - The  (REW) or  (FF) button while a movie is playing.
- ✎ The DivX DRM, Multi-audio, and embedded captions are not supported.
- ✎ Set your PC firewall program so that AllShare PC Software is a permitted program.
- ✎ You may experience file stuttering while playing a video through a network connection.

❑ My Contents Selection Screen

To play a file, move to the file using the ◀ / ▶ / ▲ / ▼ buttons, and then press the ENTER ◀ or ▶ (Play) button. The TV plays the file. The **My Contents** screen may differ depending on the way you enter the screen.

Information: Displays the selected content category (Music, for example), device (USB drive, for example), folder/file name, page, and sort criteria..



File List Section: Displays files or folders sorted by criteria you can select.

Contents mode / Device name:
You can select the desired Content Category or Device.

Operation Buttons:

- **Yellow (Edit Mode):** Lets you select music by checking the files you want to play. Only available in Music
- **Blue (Sorting):** Selects the sort list.
- **◀ / ▶ (Page):** Move to next or previous page.
- **Tools:** Displays the option menu.
- **Return:** Move to the previous page or step.

■ Videos

Playing a Video

1. Press the ◀ / ▶ / ▲ / ▼ button to select the desired video in the file list.
2. Press the ENTER ↵ button or ▶ (Play) button.
 - The file name appears on the top with its playing time.
 - If video time information is unknown, the playing time and progress bar are not displayed.



- The displayed image may differ depending on the model.

- During video playback, you can search using the ◀ and ▶ buttons.
- You can use the ◀◀ (REW), ▶▶ (FF), Pause, Stop, and Play buttons on the bottom of your remote during playback.
- Press the **RETURN** button to exit the movie
- Supported Video Subtitle Formats (for language subtitles, etc.)

Name	File extension	Format
MPEG-4 time-based text	.ttxt	XML
SAMI	.smi	HTML
SubRip	.srt	string-based
SubViewer	.sub	string-based
Micro DVD	.sub or .txt	string-based

- Supported Video Formats

File Extension	Container	Video Codec	Resolution	Frame rate (fps)	Bit rate (Mbps)	Audio Codec
*.avi *.mkv	AVI MKV	DivX 3.11 / 4.x / 5.1 / 6.0	1920x1080	6 ~ 30	8	MP3 / AC3 / LPCM / ADPCM / DTS Core
		H.264 BP / MP / HP	1920x1080	6 ~ 30	25	
		MPEG4 SP / ASP	1920x1080	6 ~ 30	8	
		Motion JPEG	640x480	6 ~ 30	8	
*.asf	ASF	DivX 3.11 / 4.x / 5.1 / 6.0	1920x1080	6 ~ 30	8	MP3 / AC3 / LPCM / ADPCM / WMA
		H.264 BP / MP / HP	1920x1080	6 ~ 30	25	
		MPEG4 SP / ASP	1920x1080	6 ~ 30	8	
		Motion JPEG	640x480	6 ~ 30	8	
*.wmv	ASF	Window Media Video v9	1920x1080	6 ~ 30	25	WMA
*.mp4	MP4	H.264 BP / MP / HP	1920x1080	6 ~ 30	25	MP3 / ADPCM / AAC
		MPEG4 SP / ASP	1920x1080	6 ~ 30	8	

File Extension	Container	Video Codec	Resolution	Frame rate (fps)	Bit rate (Mbps)	Audio Codec
*.3gp	3GPP	H.264 BP / MP / HP	1920x1080	6 ~ 30	25	ADPCM / AAC / HE-AAC
		MPEG4 SP / ASP	1920x1080	6 ~ 30	8	
*.vro	VRO VOB	MPEG1	1920x1080	24 / 25 / 30	30	AC3 / MPEG / LPCM
		MPEG2	1920x1080	24 / 25 / 30	30	
*.mpg *.mpeg	PS	MPEG1	1920x1080	24 / 25 / 30	30	AC3 / MPEG / LPCM / AAC
		MPEG2	1920x1080	24 / 25 / 30	30	
		H.264	1920x1080	6 ~ 30	25	
*.ts *.tp *.trp	TS	MPEG2	1920x1080	24 / 25 / 30	30	AC3 / AAC / MP3 / DD+ / HE-AAC
		H.264	1920x1080	6 ~ 30	25	
		VC1	1920x1080	6 ~ 30	25	

Other Restrictions

NOTE

- Video content will not play, or not play correctly, if there is an error in the content or the container.
- Sound or video may not work if the contents have a standard bitrate/frame rate above the compatible Frame/sec listed in the table above.
- If the Index Table is in error, the Seek (Jump) function is not supported.
- You may experience file stuttering while playing a video through a network connection. **for PDP 550 Series and above**
- The menu may take longer to appear if the video's bit rate exceeds 10Mbps.
- Some USB/digital camera devices may not be compatible with the TV.
- Video content can not be played, if there are many contents in one file.
- When you play video over a network connection, the video may not be played smoothly.

Video Decoder	Audio Decoder
<ul style="list-style-type: none">● Supports up to H.264, Level 4.1● H.264 FMO / ASO / RS, VC1 SP / MP / AP L4 and AVCHD are not supported.● For MPEG4 SP, and ASP:<ul style="list-style-type: none">- Below 1280 x 720: 60 frame max- Above 1280 x 720: 30 frame max● GMC is not supported.	<ul style="list-style-type: none">● Supports up to WMA 7, 8, 9, STD● WMA 9 PRO does not support 2 channel excess multi channel or lossless audio.● The WMA sampling rate 22050Hz mono is not supported.



Playing movie continuously (Resume Play)

If you exit a movie when it is playing, you can play the movie later from the point where you stopped it.

1. Select the movie file you stopped and want to resume by pressing the ◀ or ▶ button to select it from the file list section.

2. Press the ▶ (Play) or ENTER ↵ button.

3. Press the **D** button to select **Play Continuously** (Resume Play) The Movie will begin to play from where you stopped it.

☑ **Play Continuously** (Resume Play) is only available when you resume playing a movie you had stopped.



- The displayed image may differ depending on the model.

■ Music

Playing Music



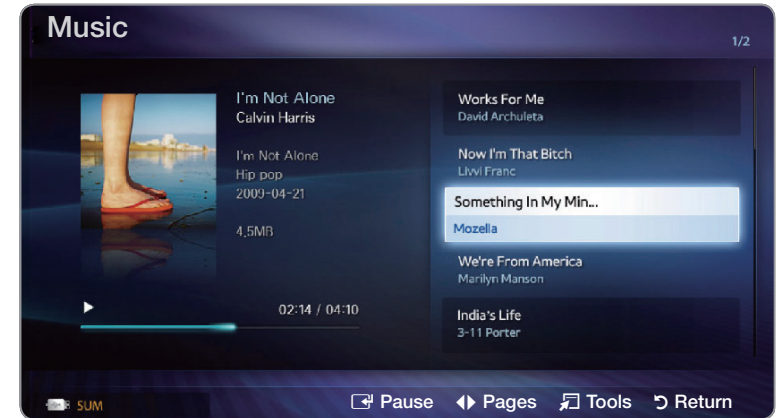

1. Press the ◀ / ▶ / ▲ / ▼ button to select the desired music file in the file list.
2. Press the ENTER ↵ button or ▶ (Play) button.
 - When the music is playing you can search using ◀◀ (REW) and ▶▶ (FF) buttons.



- The displayed image may differ depending on the model.

- 📝 **My Contents** only displays files with MP3 file extensions. Other file extensions are not displayed, even if they are saved on the same USB device.
- 📝 If the sound is abnormal when you play MP3 files, adjust the **Equalizer** in the **Sound** menu. (An over-modulated MP3 file may cause a sound problem.)

Playing selected music

1. Press the **C** (**Edit Mode**) button. A check box appears on the left side of all the music files.
2. Using the arrow keys, highlight a file you want to play, and then press **ENTER** .
 -  A  appears in the check box of the selected file.
3. Repeat for each file you want to play.
4. Press the **TOOLS** button, and then select **Play Selected Contents**.
 -  You can select or deselect all music by pressing the **Select All / Deselect All**. You can select or deselect a single file by pressing the **ENTER**  button.

■ Photos

Viewing a Photo (or Slide Show)

1. Press the ◀ / ▶ / ▲ / ▼ button to select the desired photo in the file list.
2. Press the ENTER ↵ button.
 - To view files manually, one at a time, press the left or right arrow buttons.
 - To start the slide show, press the ENTER ↵ button when the file you selected is displayed.
 - During the slide show, all files in the file list are displayed in order, starting from the file you selected.

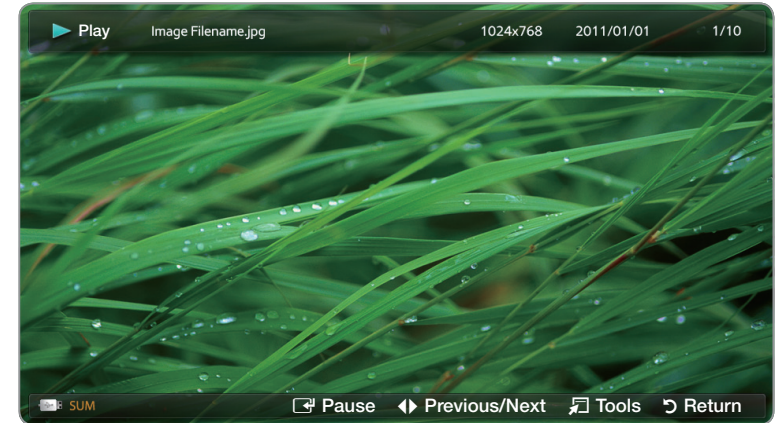

- The displayed image may differ depending on the model.

- ☞ When you press the  (Play) button in the file list, the slide show will start immediately.
- ☞ During a Slide show, press the **TOOLS** button to access additional functions such as **Slide Show Speed**, **Background Music**, **Zoom**, and **Rotate**.
- ☞ You can add background music to a slide show if you have music files on your USB device or PC by setting **Background Music** to **On** in the **Tools** menu, and then selecting music files to play.
- ☞ The **Background Music** cannot be changed until the BGM has finished loading.
- ☞ You can use the Pause, Stop, and Play buttons on the bottom of your remote during a slide show.
- ☞ When you press the Stop or Return button, the slide show stops and the main photo screen re-appears.

☐ My Contents - Additional Functions

Sorting the file list

Press the **D** button in the file list to sort the files.

Category	Operation	Videos	Music	Photos
Folder View	Displays the whole folder. You can view the photo by selecting the folder.	✓	✓	✓
Title Search	Sorts and displays the file title in Alphabet/Number/Symbol order.	✓	✓	✓
Latest Date	Sorts and shows files by the latest date.	✓		✓
Earliest Date	Sorts and shows files by the earliest date.	✓		✓

Category	Operation	Videos	Music	Photos
Artist	Sorts the music file by artist in alphabetical order.		✓	
Album	Sorts the music file by album in alphabetical order.		✓	
Genre	Sorts music files by the genre.		✓	
Monthly	Sorts and shows photo files by month.			✓



Videos/Music/Photos Play Option menu

When playing a file, press the **TOOLS** button. The Option Menu appears. Checks in the table below indicate which media the options apply to.

Option Name	Operation	Videos	Music	Photos
Title Search	You immediately load a video file you select.	✓		
Time Search	You can search a video using the ◀ and ▶ buttons at one minute interval or entering the number directly.	✓		
Shuffle Mode	You can play the music files randomly.		✓	
Repeat Mode	You can play movie and music files repeatedly.	✓	✓	

Option Name	Operation	Videos	Music	Photos
Picture Size	You can adjust the picture size to your preference.	✓		
Picture Mode	You can select the Picture Mode .	✓		✓
Sound Mode	You can select the Sound Mode .	✓	✓	✓



Option Name	Operation	Videos	Music	Photos
Subtitle Language	You can view a subtitle. You can select a specific language if the subtitle file contains multiple languages.	✓		
Subtitle Setting	You can play a video with Subtitles. This function only works if the subtitles file has the same file name as the video.	✓		



Option Name	Operation	Videos	Music	Photos
Audio	You can enjoy a video in one of the supported languages. The function is only enabled when you play stream-type files which support multiple audio formats.	✓		
Start Slide Show / Pause Slide Show	You can start or pause a Slide Show.			✓
Slide Show Speed	You can select the slide show speed during the slide show.			✓
Background Music	You can turn background music on and off when watching a Slide Show.			✓
Background Music Setting	You can select background music when watching a Slide Show.			✓

Option Name	Operation	Videos	Music	Photos
Zoom	You can zoom into images in full screen mode. Use the ENTER button to increase or decrease the zoom. Use the arrow buttons to select the area to enlarge.			✓
Rotate	You can rotate images in full screen mode. Use the left and right arrow buttons to rotate the picture. The rotation is only temporary.			✓
Information	You can see detailed information about the played file.	✓	✓	✓

- ☑ Pressing the **INFO** button while a device name is selected will display information about the selected device.
- ☑ Pressing the **INFO** button while a file is selected will display information about the selected file.

❑ Troubleshooting

If the TV seems to have a problem, first review this list of problems and solutions. If none of these troubleshooting tips apply, visit samsung.com, then click on Support, or call Samsung customer service at 1-800-SAMSUNG.

Issues	Solutions and Explanations
Picture Quality	<p>First, perform the Picture Test and to see if your TV is properly displaying the test image.</p> <ul style="list-style-type: none">● Go to MENU - Support - Self Diagnosis - Picture Test <p>If the test image is properly displayed, the poor picture may be caused by the source or signal.</p>
The TV image does not look as good as it did in the store.	<p>Store displays are typically tuned to digital, HD (high definition) channels.</p> <ul style="list-style-type: none">● If you have an analog cable/set top box, upgrade to a digital set top box. Use HDMI or Component cables to deliver HD (high definition) picture quality.● Cable/Satellite subscribers: Try HD stations from the channel line up.● Antenna connection: Try HD stations after performing an Auto program.

Issues	Solutions and Explanations
The picture is distorted: macro block error, small block, dots, pixelization	<ul style="list-style-type: none"> ● The compression of video contents may cause picture distortion especially in fast moving pictures such as sports and action movies. ● A weak signal can cause picture distortion. This is not a TV issue. ● Mobile phones used close to the TV (within 3.3 ft.) may cause noise in the picture on analog and digital channels.
Color is wrong or missing.	<ul style="list-style-type: none"> ● If you're using a component connection, make sure the component cables are connected to the correct jacks. Incorrect or loose connections may cause color problems or a blank screen.
There is poor color or the picture is not bright enough.	<ul style="list-style-type: none"> ● Adjust the Picture options in the TV menu (go to Picture Mode / Color / Brightness / Sharpness) ● Adjust the Energy Saving option in the TV menu (go to MENU – System – Eco Solution – Energy Saving) ● Try resetting the picture to view the default picture settings (go to MENU - Picture - Reset Picture)
There is a dotted line on the edge of the screen.	<ul style="list-style-type: none"> ● If the picture size is set to Screen Fit, change it to 16:9. ● Change the cable/satellite box resolution.
The picture is black and white.	<ul style="list-style-type: none"> ● If you are using an AV composite input, connect the video cable (yellow) to the Green jack of Component input 1 on the TV.

Issues	Solutions and Explanations
When changing channels, the picture freezes or is distorted or delayed.	<ul style="list-style-type: none">● If connected to a cable box, try to reset the box. (Disconnect and then reconnect the AC cord and wait until the cable box reboots. It may take up to 20 minutes.)● Set the output resolution of the cable box to 1080i or 720p.
Sound Problem	First, perform a Sound Test to confirm that your TV audio is properly operating. (go to MENU - Support - Self Diagnosis - Sound Test) If the audio is OK , the sound problem may be caused by the source or signal.
There is no sound or the sound is too low at maximum volume.	<ul style="list-style-type: none">● Please check the volume of the device (Cable/Sat Box, DVD, Blu-ray etc) connected to your TV.

Issues	Solutions and Explanations
<p>The picture is good but there is no sound.</p>	<ul style="list-style-type: none">● Set the Speaker Select option to TV Speaker in the Sound menu.● If you are using an external device, make sure the audio cables are connected to the correct audio input jacks on the TV.● If you are using an external device, check the device's audio output option (Ex. You may need to change your cable box's audio option to HDMI if you have the box connected to the TV using an HDMI cable.)● If you are using a DVI to HDMI cable, a separate audio cable is required.● If your TV has a headphone jack, make sure there is nothing plugged into it.● Reboot the connected device by disconnecting, and then reconnecting device's power cable.

Issues	Solutions and Explanations
The speakers are making an inappropriate noise.	<ul style="list-style-type: none">● Check the cable connections. Make sure a video cable is not connected to an audio input.● For antenna or Cable connections, check the signal strength. Low signal level may cause sound distortion.● Perform the Sound Test as explained above.
No Picture, No Video	
The TV turns off automatically.	<ul style="list-style-type: none">● Ensure the Sleep Timer is set to Off in the System menu.● If your PC is connected to the TV, check your PC power settings.● Make sure the AC power cord is plugged in securely to the wall outlet and the TV.● When you are watching TV, and the signal is coming from an antenna or cable connection, the TV will turn off after 10 - 15 minutes if there is no signal.

Issues	Solutions and Explanations
3D	
The 3D Active Glasses are not working correctly.	<ul style="list-style-type: none">● Make sure the glasses are turned on.● The 3D Active Glasses may not work properly if there is any other 3D product or electronic device turned on near the glasses or TV.● If there is a problem, keep other electronic devices as far away as possible from the 3D Active Glasses.
The 3D images don't look quite right.	<ul style="list-style-type: none">● The ideal viewing distance is three times or more the height of the screen.● We also recommend sitting with your eyes on a level with the screen.
The batteries in the 3D glasses don't last.	<ul style="list-style-type: none">● Turn off 3D glasses while not using them. If you leave 3D glasses on, battery lifespan is shortened

Issues	Solutions and Explanations
RF (Cable/Antenna) Connection	
The TV is not receiving all channels.	<ul style="list-style-type: none"> ● Make sure the coaxial cable is connected securely. ● Please try Auto Program to add available channels to the channel list. Go to MENU - Channel - Auto Program then select Auto and make sure the correct Cable TV signal type is set in the menu. There are 3 options (STD, HRC and IRC) ● Verify the Antenna is positioned correctly.
No Caption on digital channels.	<ul style="list-style-type: none"> ● Check Caption Setup menu. Try changing Caption Mode Service1 to CC1. ● Some channels may not have caption data.
The picture is distorted: macro block error, small block, dots, pixelization.	<ul style="list-style-type: none"> ● The compression of video contents may cause picture distortion, especially with fast moving pictures such as sports and action movies. ● A weak signal can cause picture distortion. This is not a TV problem.

Issues	Solutions and Explanations
PC Connection	
A “Mode Not Supported” message appears.	<ul style="list-style-type: none"> ● Set your PC’s output resolution so it matches the resolutions supported by the TV.
“PC” is always shown on the source list, even if a PC is not connected.	<ul style="list-style-type: none"> ● This is normal. “PC” is always shown on the source list, regardless of whether a PC is connected.
The video is OK but there is no audio.	<ul style="list-style-type: none"> ● If you are using an HDMI connection, check the audio output setting on your PC.
Network Connection for PDP 550 Series and above	
The wireless network connection failed.	<ul style="list-style-type: none"> ● The Samsung Wireless USB dongle is required to use a wireless network. ● Make sure the Network Connection is set to Wireless(General). ● Make sure the TV is connected to a wireless IP sharer (router).

Issues	Solutions and Explanations
<p>Software Upgrade over the network fails.</p>	<ul style="list-style-type: none"> ● Run Network Test in the Network menu to confirm the connection. ● If you have the latest Software (SW) version already installed, SW upgrade will not proceed.
<p>Others</p>	
<p>Purple/green rolling horizontal bars and buzzing noise from the TV speakers with Component cable connection.</p>	<ul style="list-style-type: none"> ● Remove the left and right audio connections from the set-top-box. If the buzzing stops, this indicates that the set-top-box has a grounding issue. Replace the Component video cables with an HDMI connection.
<p>Plasma TV is making humming noise.</p>	<ul style="list-style-type: none"> ● Plasma TVs typically make a soft humming sound. This is normal. It's caused by the electrical charges that are used to create the images on the screen. ● If the humming sound is loud, you may have set the brightness on the TV too high. Try setting the brightness lower. ● You can also have loud humming if the back of your Plasma TV is too close to a wall or other hard surface. Also, try rerouting your connection cables. ● An improperly installed of wall mount can also create excessive noise.

Issues	Solutions and Explanations
<p>The picture won't display in full screen.</p>	<ul style="list-style-type: none"> ● HD channels will have black bars on either side of the screen when displaying up scaled SD (4:3) contents. ● Black bars on the Top & Bottom will be shown on movies that have aspect ratios different from your TV. ● Adjust the picture size options on your external device or TV to full screen.
<p>Image Retention (Burn In) Issue.</p>	<ul style="list-style-type: none"> ● To minimize the possibility of screen burn, this unit is equipped with Pixel Shift screen burn reduction technology. Pixel Shift lets you set the picture so it moves slightly up and down (Vertical Line) and side to side (Horizontal Dot). The regular, slight movement of the picture reduces screen burn in.
<p>A "Mode Not Supported" message appears.</p>	<ul style="list-style-type: none"> ● Check the supported resolution of the TV, and adjust the external device's output resolution accordingly. Refer to the resolution settings in the user manual.

Issues	Solutions and Explanations
<p>Caption on TV menu is greyed out.</p>	<ul style="list-style-type: none"> ● You cannot select the Caption menu if you have selected a source connected to the TV via HDMI or Component. ● The external device's Capton function must also be activated.
<p>There is a plastic smell from the TV.</p>	<ul style="list-style-type: none"> ● This smell is normal and will dissipate over time.
<p>The TV Signal Information is unavailable in the Self Diagnosis menu.</p>	<ul style="list-style-type: none"> ● This function is only available with digital channels from an Antenna / RF/ Coax connection.
<p>The TV is tilted to the side.</p>	<ul style="list-style-type: none"> ● Remove the base stand from the TV and reassemble it.
<p>The channel menu is greyed out (unavailable).</p>	<ul style="list-style-type: none"> ● The Channel menu is only available when the TV source is selected.

Issues	Solutions and Explanations
<p>Your settings are lost after 30 minutes or every time the TV is turned off.</p>	<ul style="list-style-type: none"> ● If the TV is in the Store Demo mode, it will reset audio and picture settings every 30 minutes. Change the settings from Store Demo mode to Home Use mode in the Plug & Play procedure. Press the SOURCE button to select TV mode, and go to MENU → System → Plug & Play → ENTER .
<p>You have intermittent loss of audio or video.</p>	<ul style="list-style-type: none"> ● Check the cable connections and reconnect them. ● Loss of audio or video can be caused by using overly rigid or thick cables. Make sure the cables are flexible enough for long term use. If mounting the TV to a wall, we recommend using cables with 90 degree connectors.
<p>You see small particles when you look closely at the edge of the frame of the TV.</p>	<ul style="list-style-type: none"> ● This is part of the product's design and is not a defect.
<p>The PIP menu is not available.</p>	<ul style="list-style-type: none"> ● PIP functionality is only available when you are using a HDMI, PC or Component source.
<p>POP (TV's internal banner ad) appears on the screen.</p>	<ul style="list-style-type: none"> ● Select Home Use under Plug & Play mode. For details, refer to Plug & Play Feature.

❑ Anti-theft Kensington Lock

A Kensington Lock is a device you can use to physically fix your TV in place when using it in a public place. You wrap the Kensington Lock's cable around a large, immobile object and then attach the lock to the Kensington slot on the back of the TV.

The appearance and locking method may differ from the illustration depending on the manufacturer. Refer to the manual provided with the Kensington Lock for additional information on proper use. The Kensington Lock is not supplied by Samsung.

📝 Please find a “” icon on the rear of the TV. The Kensington slot is beside the “” icon.

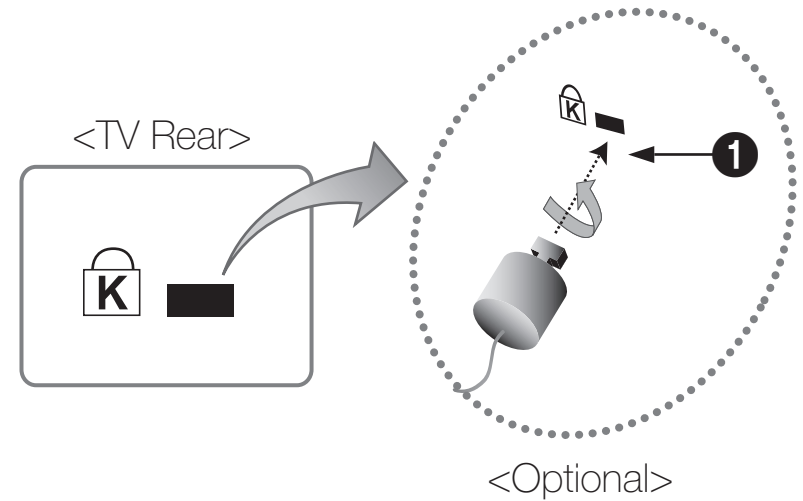

- The displayed image may differ depending on the model.

To lock the product, follow these steps:

1. Wrap the Kensington Lock cable around a large, stationary object such as desk or chair.
2. Slide the end of the cable with the lock attached through the looped end of the Kensington Lock cable.
3. Insert the locking device into the Kensington slot on the product.
4. Lock the lock.

◀  These are general instructions. For exact instructions, see the Users manual supplied with the locking device. ▶

 The locking device has to be purchased separately.

 The location of the Kensington slot may be different depending on the TV model.

□ License



TheaterSound, SRS and  symbol are trademarks of SRS Labs, Inc.
TheaterSound technology is incorporated under license from SRS Labs, Inc.



Manufactured under license from Dolby Laboratories. Dolby and the double-D symbol are trademarks of Dolby Laboratories.



Manufactured under license under U.S. Patent #'s: 5,451,942; 5,956,674; 5,974,380; 5,978,762; 6,487,535 & other U.S. and worldwide patents issued & pending. DTS and the Symbol are registered trademarks. & DTS 2.0+ Digital Out and the DTS logos are trademarks of DTS, Inc. Product Includes software. © DTS, Inc. All Rights Reserved.



DivX Certified® to play DivX® video up to HD 1080p, including premium content.

DivX®, DivX Certified® and associated logos are trademarks of DivX, Inc. and are used under license.

ABOUT DIVX VIDEO: DivX® is a digital video format created by DivX, Inc. This is an official DivX Certified® device that plays DivX video. Visit www.divx.com for more information and software tools to convert your files into DivX video.

ABOUT DIVX VIDEO-ON-DEMAND: This DivX Certified® device must be registered in order to play purchased DivX Video-on-Demand (VOD) movies. To obtain your registration code, locate the DivX VOD section in your device setup menu. Go to vod.divx.com for more information on how to complete your registration.

Covered by one or more of the following U.S. patents : 7,295,673; 7,460,668; 7,515,710; 7,519,274

Open Source License Notice

In the case of using open source software, Open Source Licenses are available on the product menu.

Open Source License Notice is written only English.