



Contact SAMSUNG WORLDWIDE

If you have any questions or comments relating to Samsung products, please contact the SAMSUNG customer care center.

Country	Customer Care Center ☎	Web Site	Address
CANADA	1-800-SAMSUNG (726-7864)	www.samsung.com	Samsung Electronics Canada Inc., Customer Service 55 Standish Court Mississauga, Ontario L5R 4B2 Canada
U.S.A	1-800-SAMSUNG (726-7864)	www.samsung.com	Samsung Electronics America, Inc. 85 Challenger Road Ridgefield Park, NJ 07660-2112



SERIES **4+**
490

Plasma TV user manual

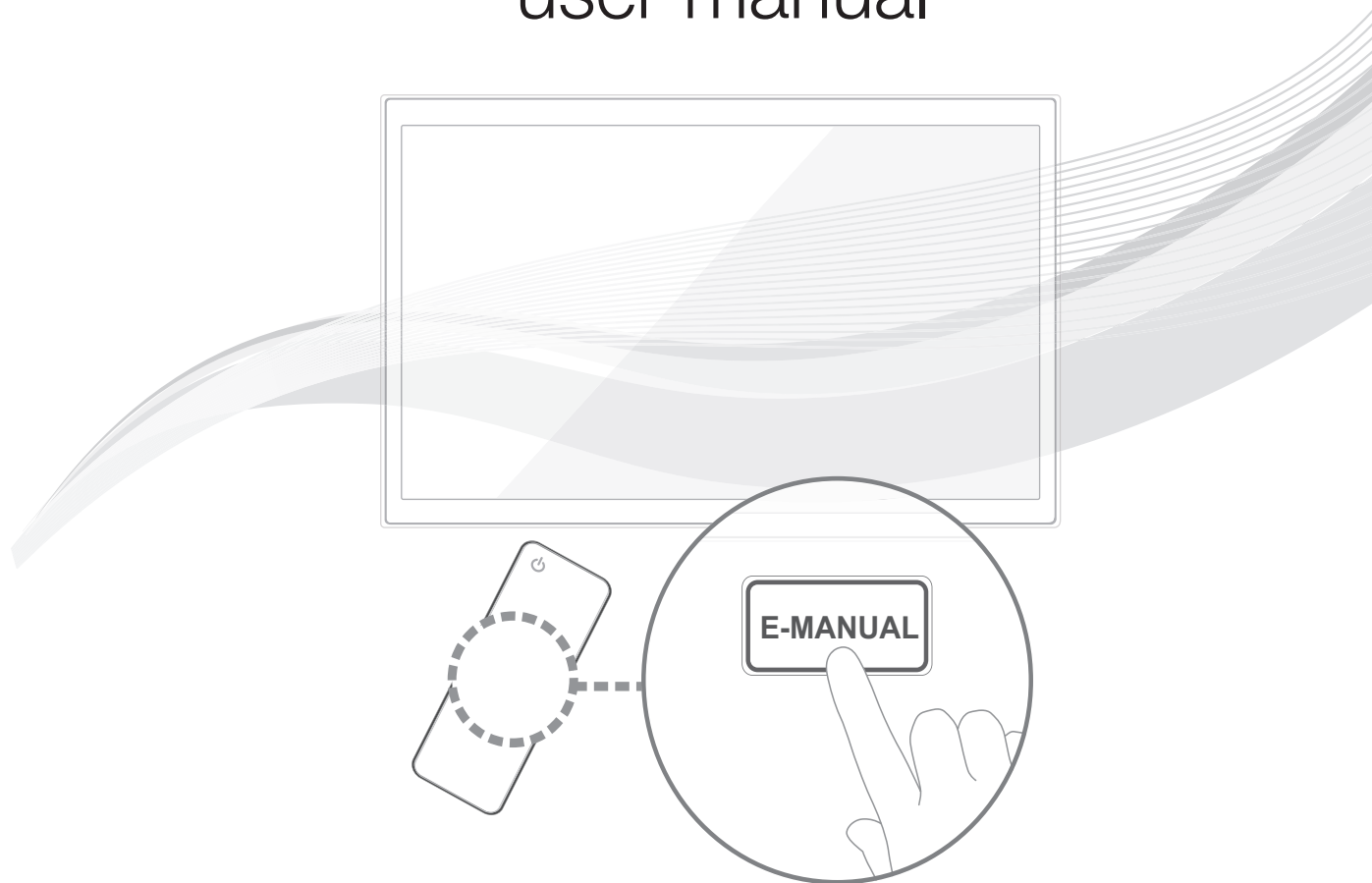

imagine the possibilities

Thank you for purchasing this Samsung product.
To receive more complete service, please register
your product at
www.samsung.com/register

Model _____ Serial No. _____



Figures and illustrations in this User Manual are provided for reference only and may differ from actual product appearance. Product design and specifications may be changed without notice.

Important Warranty Information Regarding Television Format Viewing

 See the warranty card for more information on warranty terms.

Wide screen format PDP Displays (with 16:9 aspect ratios, the ratio of the screen width to height) are primarily designed to view wide screen format full-motion video. The images displayed on them should primarily be in the wide screen 16:9 ratio format, or expanded to fill the screen if your model offers this feature, with the images constantly in motion. Displaying stationary graphics and images on the screen, such as the dark side bars on non-expanded standard format television video and programming, should be limited to no more than 5% of the total television viewing per week.

Additionally, viewing other stationary images and text such as stock market crawls, video game displays, station logos, web sites or computer graphics and patterns, should be limited as described above for all televisions. Displaying stationary images for more than 5% of total viewing time can cause uneven aging of your PDP display and leave subtle, but permanent burned-in ghost images in the PDP picture. To avoid this, vary the programming and images, and primarily display full screen moving images, not stationary patterns or dark bars. On PDP models that offer picture sizing features, use these controls to view different formats as a full screen picture.

Be careful in the selection of television formats you use for viewing and the amount of time you view them. Uneven PDP aging as a result of format selection and use, as well as burned in images, are not covered by your Samsung limited warranty.

- **SAMSUNG ELECTRONICS NORTH AMERICAN LIMITED WARRANTY STATEMENT**

Subject to the requirements, conditions, exclusions and limitations of the original Limited Warranty supplied with Samsung Electronics (SAMSUNG) products, and the requirements, conditions, exclusions and limitations contained herein, SAMSUNG will additionally provide Warranty Repair Service in the United States on SAMSUNG products purchased in Canada, and in Canada on SAMSUNG products purchased in the United States, for the warranty period originally specified, and to the Original Purchaser only.

The above described warranty repairs must be performed by a SAMSUNG Authorized Service Center. Along with this Statement, the Original Limited Warranty Statement and a dated Bill of Sale as Proof of Purchase must be presented to the Service Center. Transportation to and from the Service Center is the responsibility of the purchaser. Conditions covered are limited only to manufacturing defects in material or workmanship, and only those encountered in normal use of the product.

Excluded, but not limited to, are any originally specified provisions for, in-home or on-site services, minimum or maximum repair times, exchanges or replacements, accessories, options, upgrades, or consumables.

For the location of a SAMSUNG Authorized Service Center, please call toll-free:

– In the United States : 1-800-SAMSUNG (1-800-726-7864)

– In Canada : 1-800-SAMSUNG

Important User Information

- **Screen Image retention**

Do not display a still image (such as that from a video game) on the plasma display panel for more than a few minutes. Still images can cause screen image retention (burn in). To avoid such image retention, reduce the degree of brightness and contrast of the screen when displaying a still image.

- **Heat on the top of the Plasma TV**

The top side of the TV may become hot after long periods of use as heat dissipates from the panel through the vent hole in the upper part of the TV. This is normal and does not indicate any defect or operational failure of unit.

However, children should be prevented from touching the upper part of the TV.

- **The TV is making a 'cracking' noise.**

A 'cracking' noise may occur when the TV contracts or expands due to a change in the surrounding environment such as temperature or humidity.

This is normal and not a defect.

- **Cell Defects**

The PDP uses a panel consisting of 2,360,000 (HD-level) to 6,221,000 (FHD-level) pixels which require sophisticated technology to produce.

However, there may be a few bright or dark pixels on the screen. These pixels will have no impact on the performance of the product.

- **Avoid operating the TV at temperatures below 41°F (5°C)**

- **A still image displayed too long may cause permanent damage to the PDP Panel.**



Watching the Plasma TV in 4:3 format for a long period of time may leave traces of the borders on the left, right, top, or bottom of the screen. Playing a DVD or a game console may have a similar effect.

Damage caused by the above effect is not covered by the warranty.

- **After-images on the Screen.**

Displaying still images from Video games or a PC for longer than a certain period of time may produce partial after-images.



To prevent this effect, reduce the 'brightness' and 'contrast' when displaying still images for a long time.

- **Warranty**

Warranty does not cover any damage caused by image retention.

Burn-in is not covered by the warranty.

Accessories

-  Please make sure the following items are included with your TV. If any items are missing, contact your dealer.
-  The items' colors and shapes may vary depending on the model.
-  Check that there are no accessories hidden behind or under packing materials when you open the box.

- | | |
|------------------------------------------------------------------------------------------------------------------------------------------------------------------------------------|--------------------------------------------------------------------------------------------------------|
| <ul style="list-style-type: none"> • Remote Control (AA59-00482A) & Batteries (AAA x 2) • Owner's Instructions • Cleaning Cloth (BN63-01798B) | <ul style="list-style-type: none"> • Warranty Card / Safety Guide • Power Cord |
|------------------------------------------------------------------------------------------------------------------------------------------------------------------------------------|--------------------------------------------------------------------------------------------------------|



Ferrite Core (2EA)
(3301-002049)

-  **Ferrite Core for Power Cord:** The ferrite cores are used to shield the cables from interference. When connecting the ferrite core to a cable, open the ferrite core and clip it around the cable near the plug as shown in the figure.
 - **A** One ferrite core should be no more than 8 inches from the end of the cord that is inserted into the TV.
 - **B** If your TV came with a second ferrite core (the 43 inch model), the second core should be no more than 3/4 inches from the end of the cord that is inserted into the AC outlet.

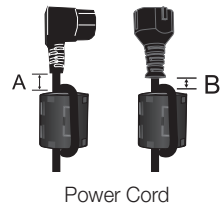



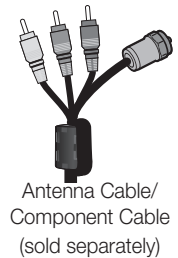



-  **Ferrite Core :** The ferrite cores are used to shield the cables from interference. When connecting a cable, open the ferrite core and clip it around the cable near the plug as shown in the figure. (51 inch model only)



Input Cables (Sold Separately)

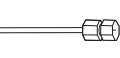
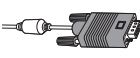

To purchase the RS232 cable, contact www.SamsungParts.com.

			
RS232 (AA39-00311A)	HDMI	HDMI-DVI	Audio
			
Component	Composite (AV)	Coaxial (RF)	VGA

Viewing the Control Panel

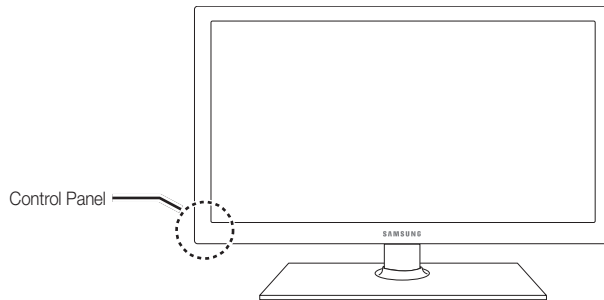
 The product color and shape may vary depending on the model.



Remote control sensor	Aim the remote control towards this spot on the TV.
Power Indicator	Blinks and turns off when the power is on and lights up in standby mode.
SOURCE 	Toggles between all the available input sources. In the on-screen menu, use this button as you would use the ENTER  button on the remote control.
MENU	Displays an on-screen menu, the OSD (on screen display), which contains controls for your TV's features.
–VOL+	Adjusts the volume. In the OSD, use the –VOL+ buttons as you would use the ◀ and ▶ buttons on the remote control.
▼ CH ▲	Changes the channels. In the OSD, use the ▼ CH ▲ buttons as you would use the ▼ and ▲ buttons on the remote control.
⏻ (Power)	Turns the TV on or off.

Standby mode

Your TV enters Standby mode when you turn it off and continues to consume a small amount of electric power. To be safe and to decrease power consumption, do not leave your TV in standby mode for long periods of time (when you are away on a vacation, for example). It is best to unplug the power cord.

Securing the Installation Space

Keep the required distances between the TV, the wall, and other objects to ensure proper ventilation. Failing to do so may result in a fire or a problem with the TV caused by an increase in its internal temperature.

 When using a stand or wall-mount, use parts provided by Samsung Electronics only.

- If you use parts provided by another manufacturer, it may result in a problem with the product or an injury due to the product falling.

Installation with a stand.

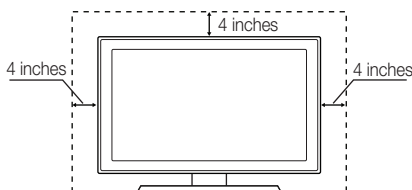

Installation with a wall-mount.

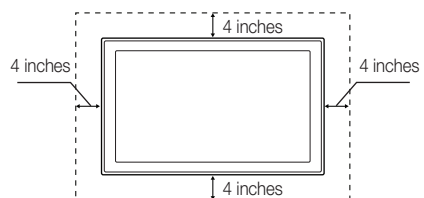

Other Warnings

 The actual appearance of the TV may differ from the images in this manual, depending on the model.

 Be careful when you touch the TV. Some parts can be somewhat hot.

Install the Stand

See the separate stand installation guide for more detailed instructions.

A 1 EA

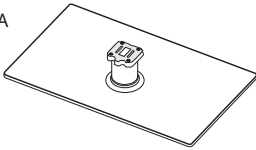

B 1 EA

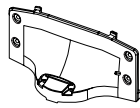

C  x4 (M4 X L12)

D  x4 (M4 X L8)

Stand (1EA)

Guide Stand (1EA)

Screws (8EA)

1

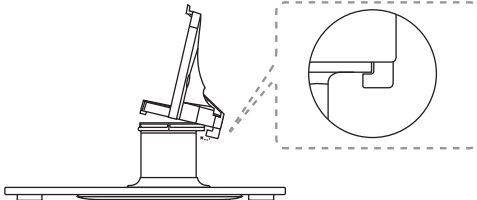

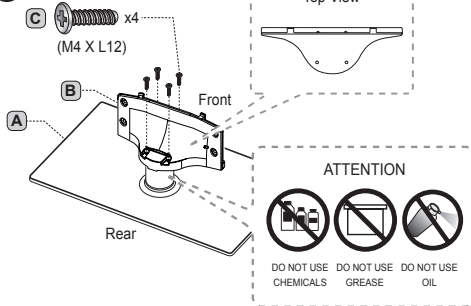

2

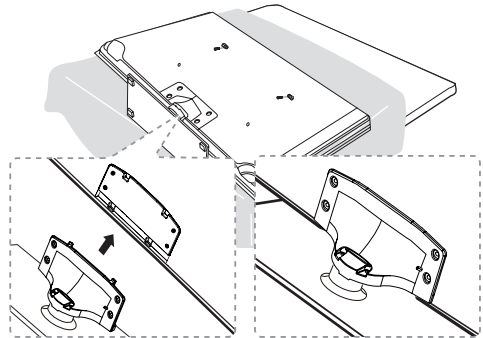

3



 Place a soft cloth over the table to protect the TV, and then place the TV on the cloth screen side down.

 Insert the Stand Guide into the slot of TV bottom side.

4

Side View

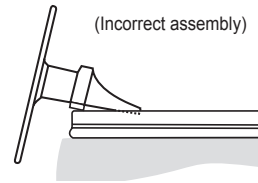
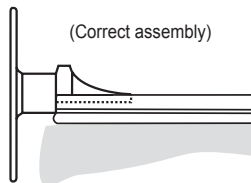

5

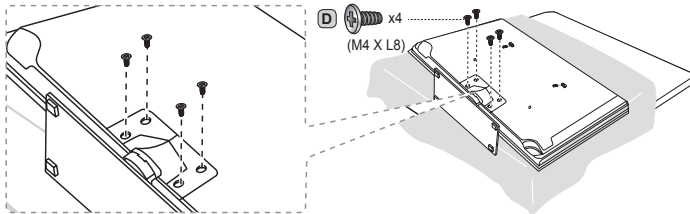

NOTE

- Make sure to distinguish between the front and back of the Stand and Guide Stand when assembling them.
- Make sure that at least two people lift and move the TV.
- Stand the product up when you fasten the screws. If you fasten the screws with the TV lying down, it may lean to one side when you stand it up.

 **Do not insert your fingers into the stand base slot of the TV when installing the stand base.**

Installing the Wall Mount

Installing the Wall Mount Kit

The wall mount kit (sold separately) allows you to mount the TV on the wall.

For detailed information on installing the wall mount, see the instructions provided with the wall mount. We recommend you contact a technician for assistance when installing the wall mount bracket. Samsung Electronics is not responsible for any damage to the product or injury to yourself or others if you elect to install the wall mount on your own.

Wall Mount Kit Specifications (VESA)

 The wall mount kit is not supplied, but sold separately.

Install your wall mount on a solid wall perpendicular to the floor. Before attaching the wall mount to surfaces other than plaster board, please contact your nearest dealer for additional information. If you install the TV on a ceiling or slanted wall, it may fall and result in severe personal injury.

NOTE

- Standard dimensions for wall mount kits are shown in the table below.
- Samsung wall mount kits contain a detailed installation manual and all parts necessary for assembly are provided.
- Do not use screws that do not comply with the VESA standard screw specifications.
- Do not use screws that are longer than the standard length or do not comply with the VESA standard screw specifications. Screws that are too long may cause damage to the inside of the TV set.
- For wall mounts that do not comply with the VESA standard screw specifications, the length of the screws may differ depending on the wall mount specifications.
- Do not fasten the screws too firmly. This may damage the product or cause the product to fall, leading to personal injury. Samsung is not liable for these kinds of accidents.
- Samsung is not liable for product damage or personal injury when a non-VESA or non-specified wall mount is used or the consumer fails to follow the product installation instructions.
- Do not mount the TV at more than a 15 degree tilt.
- Always have two people mount the TV on a wall.

Product Family	TV size in inches	VESA screw hole specs (A * B) in millimeters	Standard Screw	Quantity
PDP-TV	43~51	400 X 400	M8	4
	59~64	600 X 400		

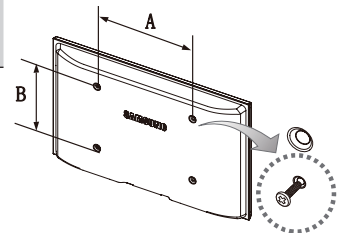

 Remove the screws in the mounting holes before you install the wall mount.



Do not install your Wall Mount Kit while your TV is turned on. It may result in personal injury due to electric shock.

Remote Control Buttons

 This remote control has Braille points on the Power, Channel, and Volume buttons and can be used by visually impaired persons.

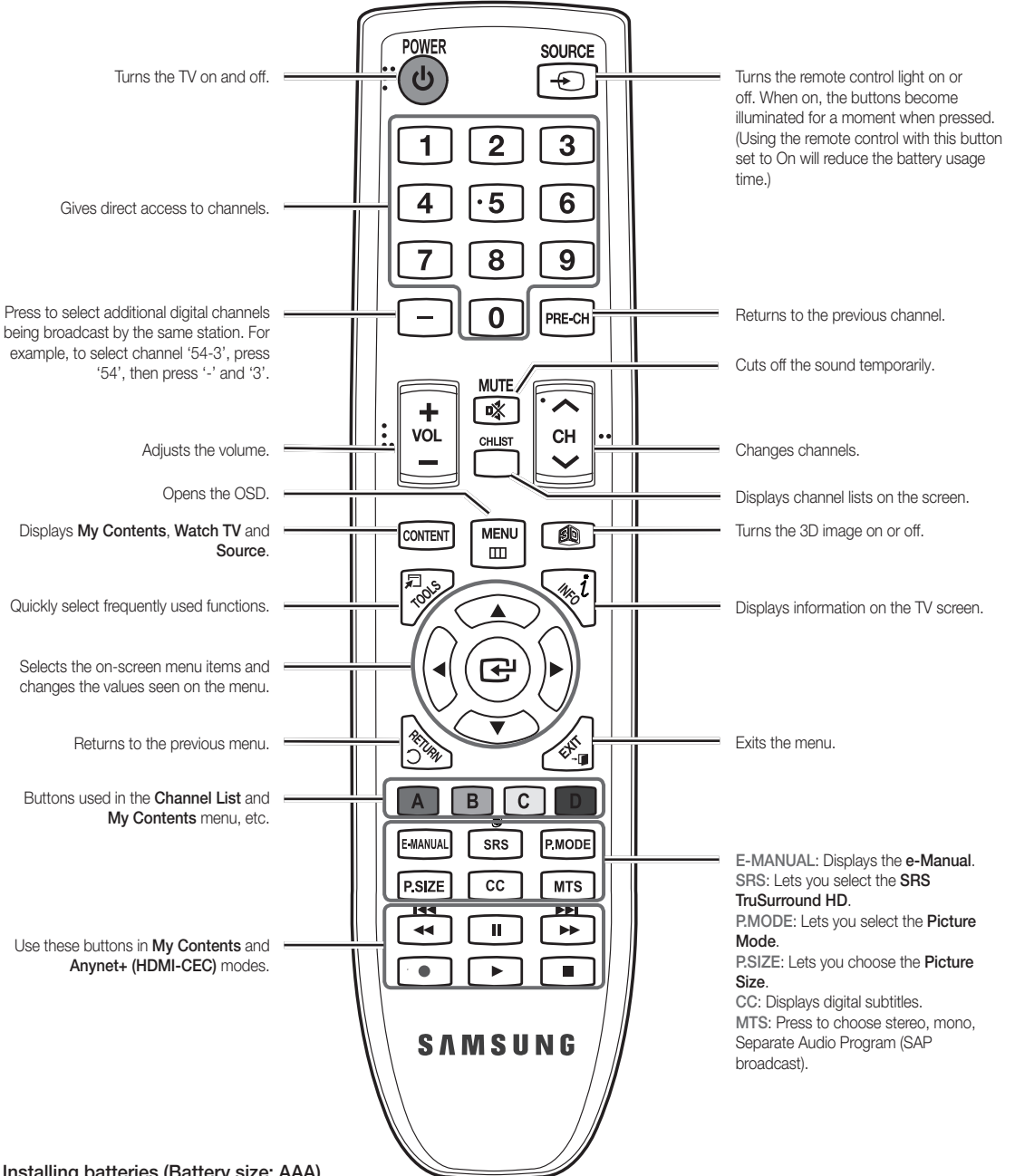

Installing batteries (Battery size: AAA)

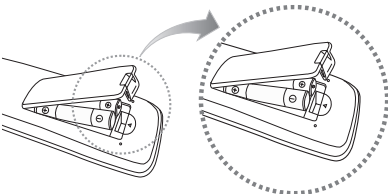

NOTE

- Use the remote control within 23 feet of the TV.
- Bright light may affect the performance of the remote control. Avoid using when near special fluorescent lights or neon signs.
- The color and shape may vary depending on the model.

How to Navigate Menu

Before using the TV, follow the steps below to learn how to navigate the menu and select and adjust different functions.

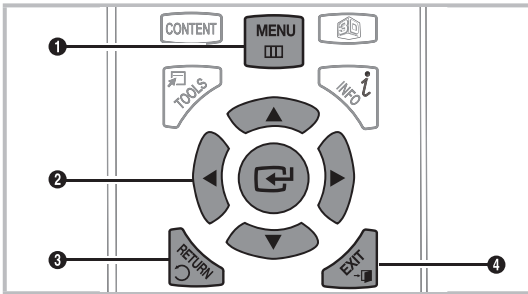

- 1 **MENU** button: Displays the main on-screen menu.
- 2 **ENTER** / Direction button: Move the cursor and select an item. Confirm the setting.
- 3 **RETURN** button: Returns to the previous menu.
- 4 **EXIT** button: Exits the on-screen menu.

How to Operate the OSD (On Screen Display)

The access steps may differ depending on the selected menu.

1	MENU	The main menu options appear on the screen: Picture, Sound, Channel, System, Support.
2	▲ / ▼	Select an icon or option with the ▲ or ▼ button.
3	ENTER	Press ENTER to access the sub-menus.
4	▲ / ▼	Select the desired submenu with the ▲ or ▼ button.
5	◀ / ▶	Adjust the value of an item with the ◀ or ▶ button. The adjustment in the OSD may differ depending on the selected menu.
6	ENTER	Press ENTER to confirm the selection.
7	EXIT	Press EXIT .

For the best cable connections to this product, be sure to use cables no thicker than 0.55 inches (14mm).

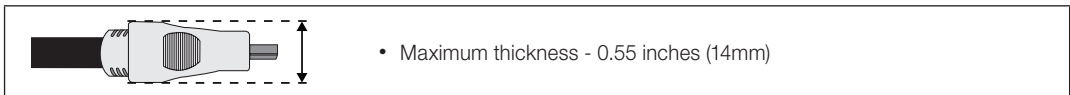

Connecting to an Antenna or Cable Connection

Connecting the power cord and an antenna or cable connection

- The PDP device may interfere with an amateur radio or AM radio.
- Using two-way radio mobile and portable units or amateur radio or AM radio near your TV may cause the TV to malfunction.

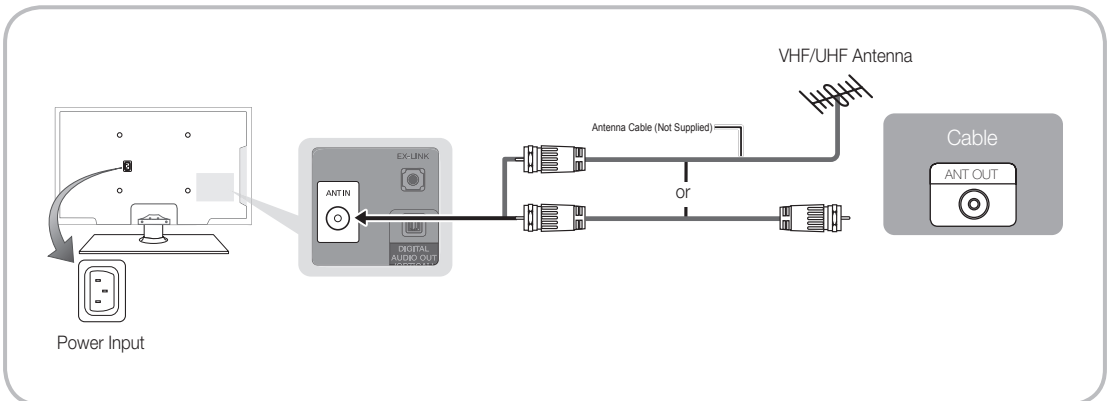



















Plug & Play (Initial Setup)

When you turn the TV on for the first time, a sequence of on-screen prompts will assist in configuring basic settings. To turn on the TV, press the **POWER**  button.



 **Plug & Play** is available only when the **Source** is set to TV.

 To return to the previous step in the **Plug & Play** sequence, press the red button, and then press **ENTER** .

 Before turning on the TV, make sure you have connected the TV to an antenna or cable connection (p. 8).

1	Selecting the OSD Language	Press the ▲ or ▼ button to select a language. Press ENTER  twice when done.	
2	Selecting the usage mode	Press the ▲ or ▼ button to select Home Use , and then press the ENTER  button twice. Select Home Use mode. Store Demo mode is for retail environments.	
3	Setting the Clock Mode	Press the ▲ or ▼ button to select Auto or Manual , and then press ENTER  twice.  If you selected Auto , you'll go to the Time Zone and DST screen. Select Time Zone or DST , and then press ENTER  . On the Time Zone screen, use the ▲ or ▼ button to select your zone, and then press ENTER  . On the DST screen, press, ENTER  , then select whether to turn DST (Daylight Savings Time) on or off. When done, press ENTER  .	
4	Selecting search options for auto tuning	Press the ▲ or ▼ button to select Air or Cable , and then press ENTER  . A check appears on your selection. Select Next , and then press the ENTER  button. You can check both if you have both connected.  If you selected Cable , you'll go to the Cable System screen. Use the ▲ or ▼ button to select Digital or Analog , and then press. ENTER  . Use the ▲ or ▼ button to select the correct cable signal format - STD , HRC , or IRC - and then press ENTER  . Most cable systems use STD . Select the correct cable signal format for both the Digital and Analog systems. When done, select Next , and the press ENTER  .	
5	Selecting and memorizing channels	The channel search will start automatically. This can take up to 30 minutes. For more information, refer to Channel → Auto Program in the e-Manual.  Press the ENTER  button at any time to interrupt the memorization process.	
6	Enjoy your TV.	Press the ENTER  button.	

If You Want to Rerun Plug & Play...

 **MENU** → **System** → **Plug & Play** → **ENTER** 

NOTE

- To change the TV's setting from **Store Demo** to **Home Use** when not in Plug & Play, press the volume button on the TV. When you see the volume bar on the screen, press and hold the **MENU** button on the TV for 5 sec.

Connecting to an AV Device

Using an HDMI or an HDMI to DVI Cable: HD connection (up to 1080i)

We recommend using the HDMI connection for the best quality HD picture.

Available devices: DVD player, Blu-ray player, HD cable box, HD STB (Set-Top-Box) satellite receiver

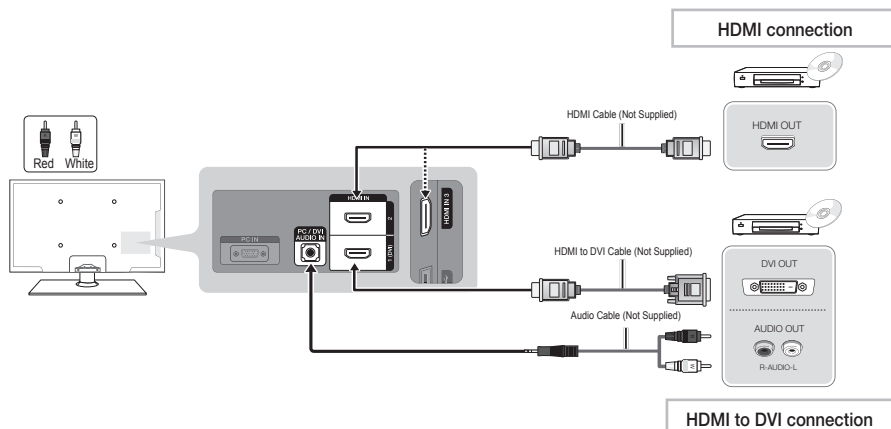

HDMI IN 1 (DVI), 2, 3, 4 / PC/DVI AUDIO IN

- For better picture and audio quality, connect to a digital device using an HDMI cable.
- An HDMI cable supports digital video and audio signals, and does not require an audio cable.
 - To connect the TV to a digital device that does not support HDMI output, use an HDMI/DVI and audio cables.
- The picture may not display normally (if at all) or the audio may not work if you connect an external device that uses an older version of HDMI mode is connected to the TV. If such a problem occurs, ask the manufacturer of the external device about the HDMI version and, if out of date, request an upgrade.
- Be sure to purchase a certified HDMI cable. Otherwise, the picture may not display or a connection error may occur.
- We recommend using a basic high-speed HDMI cable or an HDMI cable that supports Ethernet. Note that this TV does not support the Ethernet function via HDMI.

Using a Component (up to 1080i) or an Audio/Video (480i only) Cable

Available devices: DVD player, Blu-ray player, cable box, STB satellite receiver, VCR

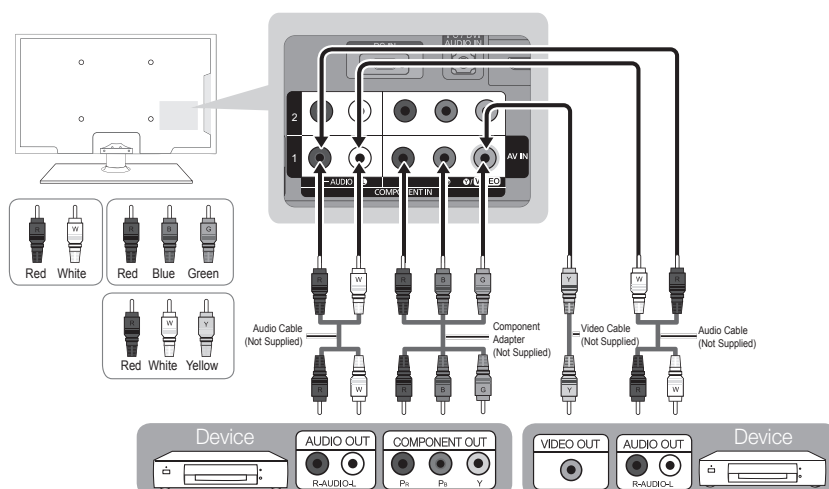

For better picture quality, we recommend the Component connection over the A/V connection.

When connecting to AV IN, the color of the AV IN [Y/VIDEO] jack (green) will not match the video cable (yellow).

Connecting to an Audio Device

Using an Optical (Digital) Cable Connection

Available devices: Digital Audio System, Amplifier, DVD home theater

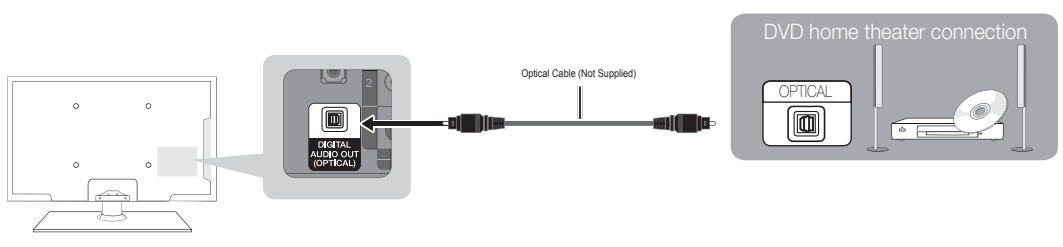

DIGITAL AUDIO OUT (OPTICAL)

- When you connect a Digital Audio System to the DIGITAL AUDIO OUT (OPTICAL) jack, decrease the volume of both the TV and the system.
- 5.1 CH (channel) audio is available when you connect the TV to an external device supporting 5.1 CH.
- When the receiver (home theater) is set to on, you can hear sound output from the TV's optical jack. When the TV is receiving a DTV signal, the TV will send 5.1 CH sound to the home theater receiver. When the source is a digital component such as a DVD player / Blu-ray player / cable box / STB (Set-Top-Box) satellite receiver and you connected it to the TV via HDMI, you will only hear 2 CH audio from the home theater receiver. If you want to hear 5.1 CH audio, connect the digital audio out jack from your DVD / Blu-ray player / cable box / STB satellite receiver directly to an amplifier or home theater.

Connecting to a PC

Using an HDMI cable or an HDMI to DVI cable or a D-sub cable

Your PC may not support an HDMI connection.

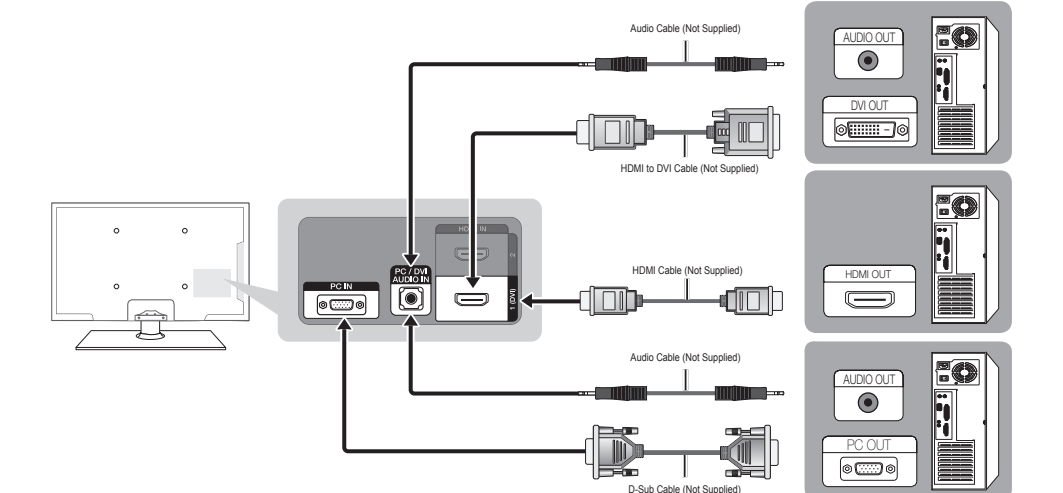

PC IN

PC/DVI AUDIO IN

HDMI IN

AUDIO OUT

DVI OUT

HDMI OUT

PC OUT

Audio Cable (Not Supplied)

HDMI to DVI Cable (Not Supplied)

HDMI Cable (Not Supplied)

Audio Cable (Not Supplied)

D-Sub Cable (Not Supplied)

PC Display Modes (D-Sub and HDMI to DVI Input)

Optimal PC resolution:

- PN43D490: 1024 X 768 @ 60 Hz
- PN51D490: 1360 X 768 @ 60 Hz

You can also select one of the standard resolutions listed in the Resolution column. The TV will automatically adjust to the resolution you choose.

Mode	Resolution	Horizontal Frequency (KHz)	Vertical Frequency (Hz)	Pixel Clock Frequency (MHz)	Sync Polarity (H / V)	PN43D490	PN51D490
IBM	640 x 350	31.469	70.086	25.175	+/-	▼	▼
	720 x 400	31.469	70.087	28.322	-/+	▼	▼
MAC	640 x 480	35.000	66.667	30.240	-/-	▼	▼
	832 x 624	49.726	74.551	57.284	-/-	▼	▼
VESA DMT	640 x 480	31.469	59.940	25.175	-/-	▼	▼
	640 x 480	37.500	75.000	31.500	-/-	▼	▼
	640 x 480	37.861	72.809	31.500	-/-	▼	▼
	800 x 600	37.879	60.317	40.000	+/+	▼	▼
	800 x 600	46.875	75.000	49.500	+/+	▼	▼
	800 x 600	48.077	72.188	50.000	+/+	▼	▼
	1024 x 768	48.363	60.004	65.000	-/-	▼	▼
	1024 x 768	56.476	70.069	75.000	-/-	▼	▼
	1024 x 768	60.023	75.029	78.750	+/+	▼	▼
1360 x 768	47.712	60.015	85.500	+/+	▼	▼	

NOTE

- For HDMI to DVI cable connection, you must use the **HDMI IN 1 (DVI)** jack.
- The interlaced mode is not supported.
- The set may operate abnormally if you select a non-standard video format.
- Separate and Composite modes are supported. SOG (Sync On Green) is not supported.

Changing the Input Source

Source

Use to select TV or an external input sources such as a DVD player / Blu-ray player / cable box / STB satellite receiver.

1. Press the **SOURCE** button on your remote.
2. Select a desired external input source.

 You can change the view mode between the **All** and **Connected** by pressing the ◀ or ▶ button.

- **TV / PC / AV / Component1 / Component2 / HDMI1/DVI / HDMI2 / HDMI3 / USB**

 You can only choose external devices that are connected to the TV. In **Source**, connected inputs will be highlighted.

 In **Source**, **PC** always stays activated.

 If the connected external devices are not highlighted, press the red button. The TV will search for connected devices.

SOURCE





Edit Name

Edit Name lets you associate a device name to an input source. To access Edit Name, press the **TOOLS** button In **Source**. The following selections appear under Edit Name:

- **VCR / DVD / Cable STB / Satellite STB / PVR STB / AV Receiver / Game / Camcorder / PC / DVI PC / DVI Devices / TV / IPTV / Blu-ray / HD DVD / DMA:** Name the device connected to the input jacks to make your input source selection easier.

 If you have connected a PC to the **HDMI IN 1 (DVI)** port with an HDMI cable, select **PC** under **Edit Name** to enter a device name.

 If you have connected a PC to the **HDMI IN 1 (DVI)** port with an HDMI to DVI cable, select **DVI PC** under **Edit Name** to enter a device name.

 If you connected an AV device to the **HDMI IN 1 (DVI)** port with an HDMI to DVI cable, select **DVI Devices** mode under **Edit Name** to enter a device name.

Information

You can see detailed information about the selected external device.

How to view the e-Manual

E-MANUAL



You can find instructions for your TV's features in the e-Manual in your TV. To use the e-Manual, press the Help button on your remote. Move the cursor using the up/down/right/left buttons to highlight a category, then a topic, and then press the ENTER button. The e-Manual displays the page you want to see.

You can also access it through the menu:

MENU **Support** **e-Manual**

If you want to return to the e-Manual, press the **E-MANUAL** button on your remote.

You can not use the **Try Now** function if the menu is not activated.

Screen Display

TV Screen: Displays the program, movie, video, etc. you are currently watching.

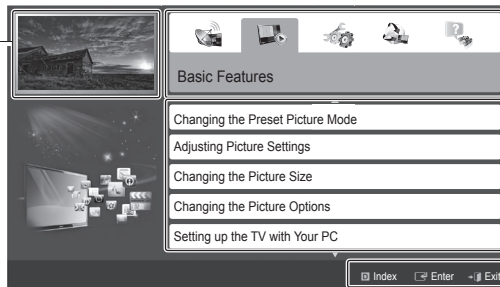

The category list. Press or button to select the category you want.

Displays the sub-menu list. Use the arrow buttons on your remote to move the cursor. Press the ENTER button to select the sub-menu you want.

Operation Buttons:

Blue (Index): Displays the Index screen.

Enter: Select a category or sub-menu.

Exit: Exit the e-Manual.

How to toggle between an e-Manual topic and the corresponding OSD menu(s).

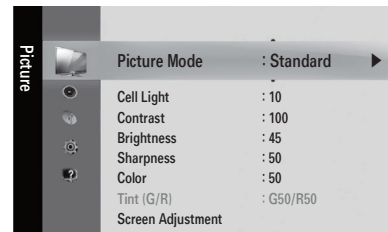
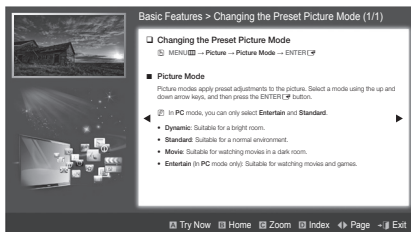

This function is not enabled in some menus.

Method 1

1. If you want to use the menu that corresponds to an e-Manual topic, press the red button to select **Try Now**.
2. To return to the e-Manual screen, press the **E-MANUAL** button.

Method 2

1. Press the ENTER button when a topic is displayed. "Do you want to execute this?" appears. Select **Yes**, and then press the ENTER button. The OSD window appears.
2. To return to the e-Manual screen, press the **E-MANUAL** button.

Viewing the Contents

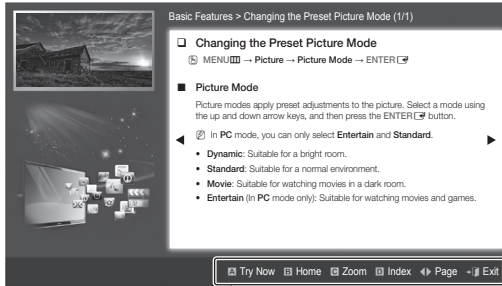

Contents Area: Contains the topic contents if you selected a sub-menu. To move to the previous or next page, press the ◀ or ▶ button.

Operation Buttons:

- A** Red (**Try Now**): Displays the OSD menu that corresponds to the topic. To return to the e-Manual screen, press the E-MANUAL button
- B** Green (**Home**): Moves to the e-Manual home screen.
- C** Yellow (**Zoom**): Magnifies a screen.
- D** Blue (**Index**): Displays the Index screen.
- ◀▶ (**Page**): Moves to previous or next page.
- | (**Exit**): Exit the e-Manual.

Using the Zoom mode

When you are viewing an e-Manual instruction page, press the yellow button to magnify the screen. You can scroll through the magnified screen by using the ▲ or ▼ buttons.

To return to the screen to normal size, press the RETURN button.

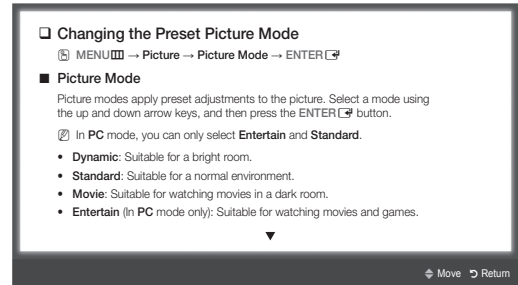

How to search for a topic on the index page

1. To search for a topic, press the left or right arrow button to select a letter, and then press ENTER. The Index displays a list of topics and keywords that begin with the letter you selected.
2. Press the ▲ or ▼ button to select a topic or keyword you want, and then press the ENTER button.
4. The e-Manual page with the topic appears.
 - To close the Index screen, press the RETURN button.

Troubleshooting

If the TV seems to have a problem, first review this list of possible problems and solutions. Also review the Troubleshooting section in the e-Manual. If none of the troubleshooting tips apply, visit “www.samsung.com,” then click on Support, or call Samsung customer service at 1-800-SAMSUNG.

Issues	Solutions and Explanations
The TV won't turn on.	<ul style="list-style-type: none"> • Make sure the AC power cord is securely plugged in to the wall outlet and the TV. • Make sure the wall outlet is working. • Try pressing the POWER button on the TV to make sure the problem is not the remote. If the TV turns on, refer to “Remote control does not work” below.
There is no picture/video.	<ul style="list-style-type: none"> • Check the cable connections. Remove and reconnect all cables connected to the TV and external devices. • Set the video outputs of your external devices (Cable/Sat Box, DVD, Blu-ray etc) to match the TV input connections. For example, if an external device's output is HDMI, it should be connected to an HDMI input on the TV. • Make sure your connected devices are powered on. • Be sure to select the TV's correct input source by pressing the SOURCE button on the remote control. • Reboot the connected device by unplugging and then reconnecting the device's power cable.
The remote control does not work.	<ul style="list-style-type: none"> • Replace the remote control batteries. Make sure the batteries are installed with their poles (+/-) in the correct direction. • Clean the sensor's transmission window on the remote. • Try pointing the remote directly at the TV from 5-6 feet away.
The cable/set top box remote control doesn't turn the TV on or off, or adjust the volume.	<ul style="list-style-type: none"> • Program the Cable/Set remote control to operate the TV. Refer to the Cable/Set user manual for the SAMSUNG TV code.

 Some functions and pictures shown in this manual are available on specific models only.

 To keep your TV in optimum condition, upgrade to the latest firmware on the Samsung web site by USB (samsung.com → Support → Downloads).

License



List of Features

- **Excellent Digital Interface & Networking:** Using its built-in HD digital tuner, you can view non-subscription HD broadcasts without a cable box or STB (Set-Top-Box) satellite receiver.
- **3D:** This exciting new feature enables you to view 3D content.
- **Anynet+(HDMI-CEC):** Allows you to control all connected Samsung devices that support Anynet+ with your Samsung TV's remote.

Securing the TV to the Wall



Caution: Pulling, pushing, or climbing on the TV may cause the TV to fall. In particular, ensure your children do not hang over or destabilize the TV. Doing so may cause the TV to tip over, causing serious injuries or death. Follow all safety precautions provided in the included Safety Flyer with your TV. For added stability and safety, you can purchase and install the anti fall device as described below.

The TV-Holder Kit (Sold Separately):

The parts below are included in the TV Holder kit. In addition, you need to provide a wood screw, screw and molly, or other screw appropriate for the wall or cabinet you intend to secure the TV-Holder string to. We recommend a size M4xL20 wood screw.



TV-Holder (BN96-15753A)







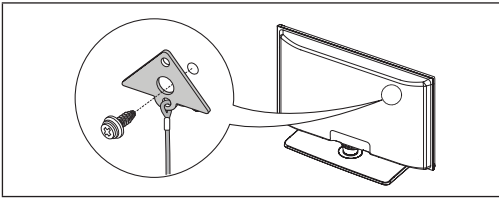

Screw (M8 X L19)

Installing the TV-Holder

1. Remove the screw attached to the back of your TV, and then connect the TV-Holder to the TV with the screw included in the TV-Holder Kit that is designated for your TV.

 Make sure to use only the appropriate supplied screw. If you use a different screw, you can damage your TV.



2. Firmly fasten the screw you provided (size M4xL20 or similar) to the wall or cabinet where the TV is to be installed.
 -  If you fasten the screw to the wall, we recommend you drive the screw into a stud. If that is not possible, use a molly to anchor the screw.
3. Tie the TV-Holder cord to the screw fastened on the wall or cabinet so that the TV is fixed. See the illustrations below.
 -  Install the TV close to the wall so that it does not fall.
 -  When attaching the TV-Holder cord to the wall, tie the cord level with the ground or slanted downwards for safety purposes.
 -  Check the cord occasionally to make sure it is secure.
 -  Before moving the TV, separate the connected cord first.

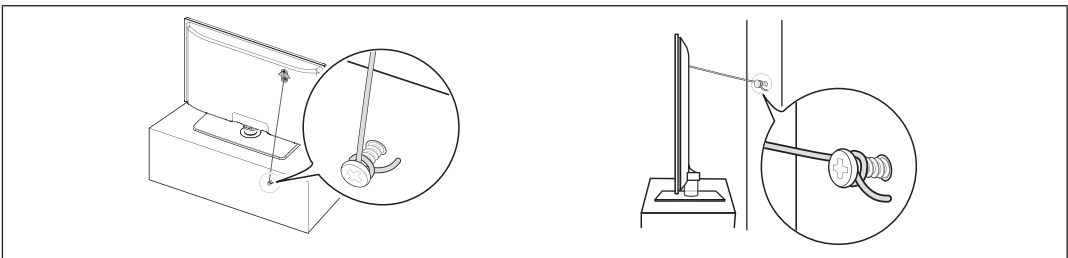

4. Verify all connections are properly secured. Periodically check the connections for any sign of fatigue or failure. If you have any doubt about the security of your connections, contact a professional installer.

To purchase the TV-Holder Kit, contact Samsung Customer Care

- In the United States: 1-800-SAMSUNG (1-800-726-7864)
- In Canada: 1-800-SAMSUNG (1-800-726-7864)

Storage and Maintenance

 If you attached some stickers on the TV screen, it remains some debris after removing the sticker. Please clean it to watch TV.

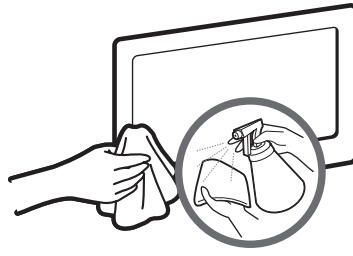
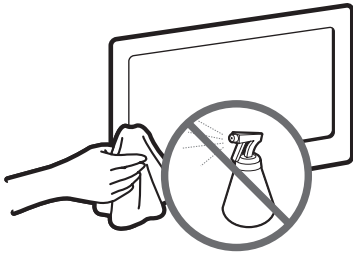

Do not spray water or a cleaning agent directly onto the product. Any liquid that goes into the product may cause a failure, fire, or electric shock.

Clean the product with a soft cloth dampened with a small amount of water.

Specifications

Environmental Considerations		
Operating Temperature	50°F to 104°F (10°C to 40°C)	
Operating Humidity	10% to 80%, non-condensing	
Storage Temperature	-4°F to 113°F (-20°C to 45°C)	
Storage Humidity	5% to 95%, non-condensing	
Stand Swivel (Left / Right)	-20° ~ 20°	
Model Name	PN43D490	PN51D490
Screen Size (Diagonal)	43" Class (43.0" measured diagonally)	51" Class (50.7" measured diagonally)
Sound (Output)	10 W X 2	
Dimensions (WxDxH)		
Body	39.8 x 2.2 x 24.5 inches (1011.8 x 56.0 x 622.4mm)	46.8 x 2.2 x 27.8 inches (1187.8 x 56.0 x 706.6 mm)
With stand	39.8 x 2.2 x 27.5 inches (1011.8 x 56.0 x 698.7 mm)	42.8 x 2.2 x 30.8 inches (1087.8 x 56.0 x 782.9 mm)
Weight		
Without Stand	35.3 lbs (16.0 Kg)	49.6 lbs (22.5 Kg)
With Stand	41.9 lbs (19.0 Kg)	56.2 lbs (25.5 Kg)
Display Resolution	1024 x 768	1360 x 768

 Design and specifications are subject to change without prior notice.

 This device is a Class B digital apparatus.

 For information about the power supply, and more about power consumption, refer to the label attached to the product.

Dispose unwanted electronics through an approved recycler.

To find the nearest recycling location, go to our website:

www.samsung.com/recyclingdirect Or call, (877) 278 - 0799

Dimensions

■ Front view / Side view

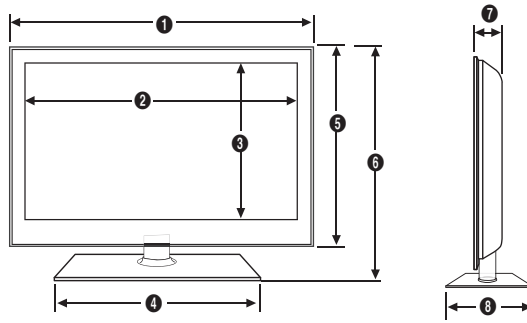

(Unit: inches)

Model name	1	2	3	4	5	6	7	8
PN43D490	39.8	37.6	21.6	20.1	24.5	27.5	2.2	12.0
PN51D490	46.8	44.6	25.0	20.1	27.8	30.8	2.2	12.0

■ Rear view

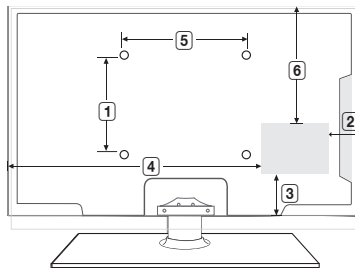

(Unit: inches)

Model name	1	2	3	4	5	6
PN43D490	15.7	3.7	3.4	29.6	15.7	16.7
PN51D490	15.7	3.9	4.7	36.2	15.7	18.7

NOTE: All drawings are not necessarily to scale. Some dimensions are subject to change without prior notice. Refer to the dimensions prior to performing installation of your TV. Not responsible for typographical or printed errors.

© 2011 Samsung Electronics America, Inc

***This page is intentionally
left blank.***