

Speed Queen

User's Guide

for your
frontload
washer

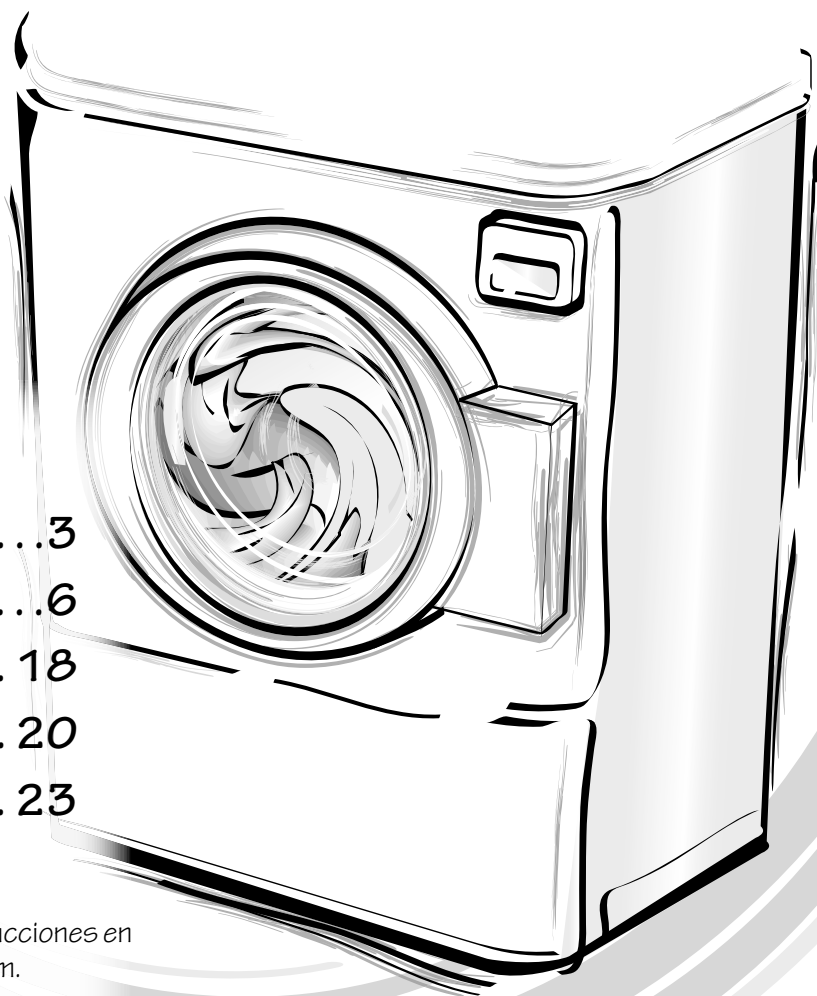

Inside . . .

Safety Information	3
Operation	6
Clothing Care	18
Maintenance	20
Troubleshooting	23

Para bajar una copia de estas instrucciones en español, visite www.speedqueen.com.



WARNING

For your safety and to reduce the risk of fire or an explosion, do not store or use gasoline or other flammable vapors and liquids in the vicinity of this or any other appliance.

W022

Product Registration

New owners of Speed Queen equipment are encouraged to register their appliance to insure proper warranty coverage.

Register online at www.speedqueen.com.

All information will be kept confidential and will not be distributed to other parties.

Safety Information

Explanation of Safety Messages

Throughout this manual and on machine decals, you will find precautionary statements (“DANGER,” “WARNING,” and “CAUTION”) followed by specific instructions. These precautions are intended for the personal safety of the operator, user, servicer, and those maintaining the machine.

	DANGER
Indicates an imminently hazardous situation that, if not avoided, will cause severe personal injury or death.	

	WARNING
Indicates a hazardous situation that, if not avoided, could cause severe personal injury or death.	

	CAUTION
Indicates a hazardous situation that, if not avoided, may cause minor or moderate personal injury or property damage.	

Additional precautionary statements (“IMPORTANT” and “NOTE”) are followed by specific instructions.

IMPORTANT: The word “IMPORTANT” is used to inform the reader of specific procedures where minor machine damage will occur if the procedure is not followed.

NOTE: The word “NOTE” is used to communicate installation, operation, maintenance or servicing information that is important but not hazard related.

Important Safety Instructions

Save These Instructions

	WARNING
To reduce the risk of fire, electric shock, serious injury or death to persons when using your washer, follow these basic precautions:	
W023	

1. Read all instructions before using the washer.
2. Refer to the *Grounding Information* in the Installation Instructions for the proper grounding of the washer.
3. Do not wash articles that have been previously cleaned in, washed in, soaked in, or spotted with gasoline, dry-cleaning solvents, or other flammable or explosive substances as they give off vapors that could ignite or explode.
4. Do not add gasoline, dry-cleaning solvents, or other flammable or explosive substances to the wash water. These substances give off vapors that could ignite or explode.

5. Under certain conditions, hydrogen gas may be produced in a hot water system that has not been used for two weeks or more. HYDROGEN GAS IS EXPLOSIVE. If the hot water system has not been used for such a period, before using a washing machine or combination washer-dryer, turn on all hot water faucets and let the water flow from each for several minutes. This will release any accumulated hydrogen gas. THE GAS IS FLAMMABLE. DO NOT SMOKE OR USE AN OPEN FLAME DURING THIS TIME.
6. Do not allow children to play on or in the washer. Close supervision of children is necessary when the washer is used near children. This is a safety rule for all appliances.
7. Before the washer is removed from service or discarded, remove the door to the washing compartment.
8. Do not reach into the washer if the wash drum is moving.
9. Do not install or store the washer where it will be exposed to water and/or weather.
10. Do not tamper with the controls.
11. Do not repair or replace any part of the washer, or attempt any servicing unless specifically recommended in the user-maintenance instructions or in published user-repair instructions that you understand and have the skills to carry out.
12. To reduce the risk of an electric shock or fire, DO NOT use an extension cord or an adapter to connect the washer to the electrical power source.
13. Use your washer only for its intended purpose, washing clothes.
14. ALWAYS disconnect the washer from electrical supply before attempting any service. Disconnect the power cord by grasping the plug, not the cord.
15. Install the washer according to the Installation Instructions. All connections for water, drain, electrical power and grounding must comply with local codes and be made by licensed personnel when required. Do not do it yourself unless you know how!
16. To reduce the risk of fire, clothes which have traces of any flammable substances such as vegetable oil, cooking oil, machine oil, flammable chemicals, thinner, etc. or anything containing wax or chemicals such as in mops and cleaning cloths, must not be put into the washer. These flammable substances may cause the fabric to catch on fire by itself.
17. Do not use fabric softeners or products to eliminate static unless recommended by the manufacturer of the fabric softener or product.
18. Keep your washer in good condition. Bumping or dropping the washer can damage safety features. If this occurs, have your washer checked by a qualified service person.
19. Replace worn power cords and/or loose plugs.
20. Be sure water connections have a shut-off valve and that fill hose connections are tight. CLOSE the shut-off valves at the end of each wash day.
21. Loading door MUST BE CLOSED any time the washer is to fill, tumble or spin. DO NOT bypass the loading door by permitting the washer to operate with the loading door open.
22. Check washer for water leaks after each use. If water is found, turn off the water supply and call for service immediately. Don't use washer until it is repaired by an authorized service agent.
23. If the washer's volume or type of sound changes from what is normally heard, call an authorized service agent immediately to prevent possible damage to other components.

24. Never start a cycle and leave the property without first checking to make sure the wash cycle is complete.
25. Always read and follow manufacturer's instructions on packages of laundry and cleaning aids. Heed all warnings or precautions. To reduce the risk of poisoning or chemical burns, keep them out of the reach of children at all times (preferably in a locked cabinet).
26. Always follow the fabric care instructions supplied by the garment manufacturer.
27. Never operate the washer with any guards and/or panels removed.
28. DO NOT operate the washer with missing or broken parts.
29. DO NOT by-pass any safety devices.
30. Failure to install, maintain, and/or operate this machine according to the manufacturer's instructions may result in conditions which can produce bodily injury and/or property damage.
31. Replace washer fill hoses every five years.
32. If unit is a stacked washer and dryer, do not operate washer and dryer if the units have been separated.

NOTE: The WARNING and Important Safety Instructions appearing in this manual are not meant to cover all possible conditions and situations that may occur. Observe and be aware of other labels and precautions that are located on the machine. They are intended to provide instructions for safe use of the machine. Common sense, caution and care must be exercised when installing, maintaining, or operating the washer.

Always contact your dealer, distributor or service agent about any problems or conditions you do not understand.



Operation

Before Washing

Prepare Wash Load

Empty Pockets and Cuffs

Make sure all pockets are empty and turn them inside out. One bobby pin, metal or plastic toy, nail or sharp object in a load can catch laundry, cause tears and plug the pump. Facial tissue left in a pocket will produce extreme “lint”. A crayon or lipstick in a wash load may cause stains that cannot be removed. Roll down cuffs and shake out grass, sand and gravel.

Mend Rips and Tears

Little holes can become bigger in the washer. Mend holes and tears before placing garments in the washer.

Close Zipper and Fasten Hooks

These can catch on garments in a wash load and tear them. Tie belts and sashes so they won't wind around clothes.

Put Small Items in Bag

Small items such as baby socks may get stuck around the door. Put them inside a mesh garment bag.

Check For Colorfastness

Squeeze a portion of garment in warm or hot sudsy water. If the color bleeds or runs, wash the item separately in cold water.

Sort Items

Different items use different wash cycles and temperatures. Always follow the manufacturer's care label. Proper sorting is easy if you follow a few guidelines:

1. Sort by Color:

Separate items into loads of whites, darks, lights and non-colorfast.

Whites



TLW1991N



TLW1990N

2. Sort by Fabric and Construction:

Separate items into loads of cottons/linens, permanent press, synthetics/blends/poly knits, and delicates.

Cottons



TLW1991N

3. Sort by Temperature:

Separate items into loads that can be washed in cold, warm or hot water.

Cold



TLW1991N

4. Sort by Type and Amount of Soil:

Heavily soiled clothes will need extra treatment. Lightly soiled clothes can become dingy if washed with heavily soiled items.

5. Sort Lint “Shedders” From Lint “Receivers”:

Some fabrics attract lint and should not be washed with lint-shedding loads. Lint shedders are cottons, terry towels, chenille bedspreads, rugs and clothes that have been heavily bleached.

Lint receivers are synthetics, permanent or durable press, knits (including socks), corduroy, and other smooth fabrics.

Pretreat

Pretreat shirt collars and cuffs with a pretreat product or liquid detergent when placing them in the washer. Before washing, treat special stains individually.



WARNING

Do not wash or dry items soiled with vegetable or cooking oils. Some oils may remain after washing and may cause the fabric to catch on fire by itself.

W527

Loading the Washer

Load Articles

- Load items by the amount of space they take up, not by their weight. Mix large and small items in a load to get the best washing results.
- Load items loosely into the wash drum. The bulk of the clothes rather than the weight will determine load size.

Bulky Items

- Use the DELICATES/BULKY cycle for bulky items such as blankets and comforters. The cycle includes gentle agitation to clean items delicately and thoroughly. The extra rinse cycle may be selected to ensure complete removal of soap residue. A final spin extracts the moisture at a low speed to maintain the load's balance and minimize wear to the articles.

Load Sizes

- Load sizes vary. Small and large items should be washed together to create a balanced load. If washing a large item, two bath towels should be added to even the load.
- Smaller loads can create an unbalanced condition and cause premature wear on the washer. Do not hesitate to fill the entire inner drum of the washer. The load will compress a great deal when wet. This allows room for proper tumbling.

Water Level

- The washer will automatically adjust the water level to the type and size of the load during any fill.

Wash Temperature

Hot Water

The Hot Wash temperature is determined by the actual temperature of the hot water supplied to the washer. Hot water is the most effective for cleaning, but it is not recommended for all fabric types (read labels).

Warm Water

The Warm Wash is useful for providing a thorough cleaning on lightly soiled clothing without damaging fabric or adding to color fading.

The Warm Rinse is useful in preventing wrinkles on certain fabrics. Check labels for fabric manufacturer's recommendations.



Cold Water

The Cold Wash is ideal for delicate items. Although its cleaning abilities are not as great with hot or warm water, it is useful for colors that bleed easily and for sensitive fabrics.

The Cold Rinse is optional in every cycle and is the most beneficial for fabrics. **Cold rinses reduce wrinkling and color fading. In addition, cold rinses will save money and energy.**

NOTE: In wash temperatures colder than 60°F (16°C), detergents do not dissolve well. This may cause ineffective cleaning, or lint and residue to form.

NOTE: Always follow manufacturer's care labels.

Wash Temperature Guide

Water Temperature	Use	Comments
HOT (approximately 120°F [49°C] or as determined by outside hot water supply)	<ul style="list-style-type: none"> Sturdy whites and colorfast items Work clothes Soiled items Diapers 	<ul style="list-style-type: none"> Best cleaning for soiled items Good for sanitizing
WARM (approximately 100° F [38°C])	<ul style="list-style-type: none"> Rinsing of some items (OPTIONAL) Light and moderately soiled items Non-colorfast or dark colors Permanent press Silks, woolens, nylon, acrylic 	<ul style="list-style-type: none"> Reduces wrinkling in permanent press fabrics Less fading Reduces shrinking in knits
COLD (approximately 60° F [16°C])	<ul style="list-style-type: none"> Rinsing of most items Non-colorfast fabrics Extra delicate clothing 	<ul style="list-style-type: none"> Saves energy Reduces color fading Reduces wrinkling Reduces shrinking

Energy

You can save energy when washing by following a few guidelines:

1. Heating water accounts for the greatest energy expense when washing. Save on heating water by using warm or cold washes as well as cold rinses.
2. Wash full loads, but do not overload.

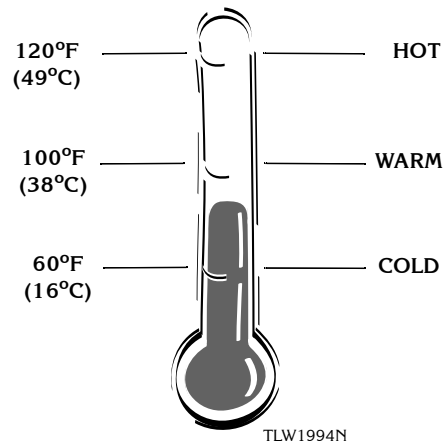

Operating Your Washer

	WARNING
<p>To reduce the risk of fire, electric shock, serious injury or death to persons, read the <i>Safety Information</i> section before operating your washer.</p>	
<small>W522</small>	

NOTE: Always follow manufacturer's care labels.

Determine Proper Cycle

NOTE: The cycle times might be longer if a **Boosted Hot Wash**, if available, is selected.

Regular Cycle

Use for sturdy items, like play or work clothes, towels, T-shirts, etc. This cycle includes a wash tumble and two rinses with an optional third rinse. The final spin starts with a medium spin and finishes with a high spin.

Perm Press Cycle

Use for permanent press items and synthetics. This cycle includes a wash tumble and two rinses with an optional third rinse. The final spin starts with a medium spin and finishes with a high spin.

Delicates/Bulky Cycle

Wash delicate items usually washed by hand on this cycle. The cycle includes a wash tumble and two rinses with an optional third rinse. The final spin extracts moisture at a low spin.

Rinse & Spin Cycle

Use to quickly rinse items. The rinse is followed by a high spin.

Spin Only Cycle

Use to extract water from wet items. This cycle uses the high spin.

OFF

Use to stop a cycle or change cycles.

Extra Rinse

This optional setting is useful for detergent sensitive skin. By turning the "EXTRA RINSE" knob to "ON," the REGULAR, PERM PRESS and DELICATES/BULKY cycles will each provide an additional rinse.



To Wash Clothes

IMPORTANT: Before using your new washer, make sure the washer cord is plugged into a 120 Volt electrical outlet that has the proper grounding and polarity. Make sure the washer hoses are connected to the hot and cold water faucets, and that the faucets are turned on. Be sure the drain hose is not kinked and is inserted into a drain. Refer to the **INSTALLATION INSTRUCTIONS** for details of proper washer installation.

IMPORTANT: Prior to first wash, use an all purpose cleaner, or a detergent and water solution, and a damp cloth to remove shipping dust from inside of wash drum.

1. Get the clothes ready for washing. Empty pockets and cuffs. Sort items into separate loads. Pretreat stains and heavily soiled areas.



TLW1991N

IMPORTANT: Remove all sharp objects from laundry to avoid tears and rips to items during normal machine operation.

2. Measure and add **low sudsing, high efficiency (HE) detergent**, fabric softener and bleach to the dispenser drawer. Refer to section on *Using Your Dispenser Drawer*. Follow instructions on detergent package for amount to use.

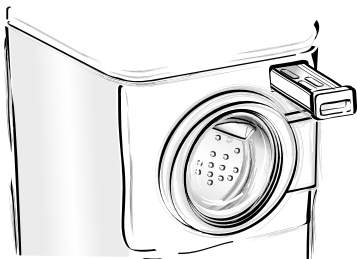

FLW2169N

NOTE: High efficiency (HE) detergents are designed especially for frontload washers to reduce oversudsing and maximize cleaning results. Look for the HE logo or “high efficiency” on the detergent’s label.



IMPORTANT: If using non-HE detergent, avoid oversudsing by using only 1/2 of the detergent manufacturer's recommended amount.

3. Load clothes into wash drum. Refer to section on *Load Sizes*.

NOTE: Small items such as baby socks may get caught around the door. Place these articles inside a mesh garment bag.



FLW2170N

When washing bulky items such as blankets and comforters, use the DELICATES/BULKY cycle. The cycle includes gentle agitation to clean items delicately and thoroughly. The extra rinse cycle may be selected to ensure complete removal of soap residue. A final spin extracts the moisture at a low speed to maintain the load's balance and minimize wear to the articles.

4. Close the loading door tightly. The washer will not operate with the loading door open.

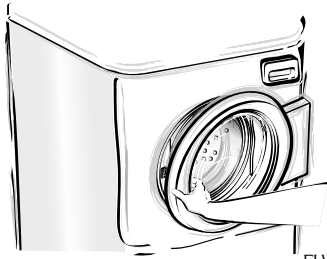

FLW2171N

6. Select EXTRA RINSE if desired.

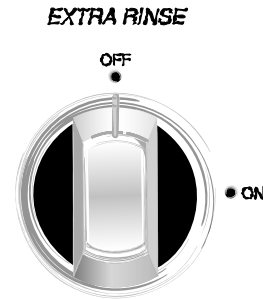

FLW2220N

	WARNING
<p>To reduce the risk of serious injury, do not bypass the loading door switch by permitting the washer to tumble or spin with the loading door open.</p>	
W095	

5. Set WASH/RINSE temperatures.

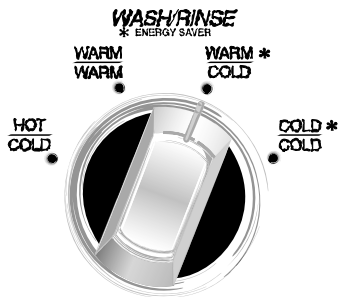

FLW2219N

There are four WASH/RINSE temperatures available – Hot Wash/Cold Rinse, Warm Wash/Warm Rinse, Warm Wash/Cold Rinse, Cold Wash/Cold Rinse.

The Energy Saver settings, marked with an asterisk (*), show which temperature settings will use the least energy.

Refer to the *Water Temperature* section for the temperature that works best for your garments.

	WARNING
<p>Window may be hot in the Hot Wash Cycle.</p>	
W326	

The extra rinse control is useful for detergent sensitive skin. By turning the EXTRA RINSE knob to ON, the REGULAR, PERM PRESS, and DELICATES/BULKY cycles will each provide an additional rinse. If the rinse is desired, turn the knob to ON. When the extra rinse is not wanted, OFF should be selected.

7. Select the cycle according to the type of fabric being washed. Use the indented line on the cycle selector knob as a guide.
8. Turn the START knob to the right to start the washer. The DOOR light will come on after a short delay, water fill will begin, and wash drum will begin tumbling.

NOTE: Washer door MUST be closed tightly to start washer.

If items need to be added or removed after a cycle has started, turn the cycle selector knob to the OFF position. Wait until the DOOR light goes off (approximately 45 seconds after cycle has been stopped), open door, add or remove items, and start the cycle again.



There is no agitator on this washer. Instead, the clothing gently tumbles through the water. The wash action consists of a period of tumbling in one direction, a brief pause, and then a reverse tumble in the opposite direction. The pauses are part of the tumble action and add to the unique cleaning capabilities of the washer. They are part of the cycle.

To Change Cycles

If the selected cycle is not the correct cycle for the fabric being washed, you may change the cycle selection at any time until the first wash fill is complete. Once the washer has filled for the first part of the cycle (the wash portion), the current cycle must be aborted and a new cycle must be started.

To change the cycle before the first fill is complete:

Change the cycle selected on the cycle selector knob.

To change the cycle after the first fill is complete and before the first wash is complete:

1. Abort the current cycle by changing the cycle selector knob to the OFF position.
2. Set the WASH/RINSE temperature selector.
3. Set cycle selector knob.
4. Turn on extra rinse, if desired.
5. Press and hold the START button for two seconds.

To change the cycle after the first wash is complete:

NOTE: This should only be done if the speed of the final extract is incorrect for the fabric being washed. For example, if washing delicate items on the REGULAR cycle, the high speed extract may damage the fabric. Or, if washing towels or jeans on the DELICATES/BULKY cycle, the lower speed extract would increase drying time.

1. Abort the current cycle by changing the cycle selector switch to the OFF position.
2. Restart the cycle from the beginning. Refer to the *To Wash Clothes* section.

To Pump Out Water After Aborting Cycle

Run a SPIN ONLY cycle. This cycle will perform a high speed extract operation that will pump all of the water out of the washer.

Manual Soaking

To soak a clothes load, start a wash in the desired cycle. After fill is complete and wash drum has started tumbling, turn the cycle selector knob to OFF. When the clothes have soaked the desired length of time, turn the cycle selector knob to the cycle and press the start button to restart the cycle.

DOOR Light

When the washer is started, the DOOR light will come on after a short delay. The light will turn off approximately 45 seconds after the cycle is complete.

WASH Light

This light comes on during the wash part of each cycle.

RINSE Light

This light comes on for the rinse portion of each cycle.

FINAL SPIN Light

This light comes on while the wash load is in the final spin of the cycle.

Out of Balance Load

If at the end of the cycle, the load is dripping wet, the washer has limited the spin speed. This is to prevent damage to the unit if there is a severely unbalanced load.

If this condition occurs, redistribute the load manually and run a RINSE & SPIN cycle.

If the condition persists, consider steps discussed in the *Before Washing* section.



Available Washing Cycles

The cycles of your washer include several different settings. Refer to the table below for what can be expected during the cycles that you select.

Regular Cycle		
	Activity	Water Temperatures
Wash	Fill & Tumble	Hot, Warm or Cold
Spin	Pulse Spin	
Rinse	Fill & Tumble	Cold
Spin	Pulse Spin	
Extra Rinse (Optional)	Fill & Tumble	Cold
Spin	Pulse Spin	
Final Rinse	Fill & Tumble	Warm or Cold
Spin	Pulse Spin	
Spin	Medium Spin (650 rpm)	
Final Spin	High Spin (1000 rpm)	
Fluff	Tumble	
Perm Press Cycle		
	Activity	Water Temperatures
Wash	Fill & Tumble	Hot, Warm or Cold
Spin	Pulse Spin	
Rinse	Fill & Tumble	Cold
Spin	Pulse Spin	
Extra Rinse (Optional)	Fill & Tumble	Cold
Spin	Pulse Spin	
Final Rinse	Fill & Tumble	Warm or Cold
Spin	Pulse Spin	
Spin	Medium Spin (650 rpm)	
Final Spin	High Spin (1000 rpm)	
Fluff	Tumble	

Delicates/Bulky Cycle		
	Activity	Water Temperatures
Wash	Fill & Tumble	Hot, Warm or Cold
Spin	Pulse Spin	
Rinse	Fill & Tumble	Cold
Spin	Pulse Spin	
Extra Rinse (Optional)	Fill & Tumble	Cold
Spin	Pulse Spin	
Final Rinse	Fill & Tumble	Warm or Cold
Spin	Pulse Spin	
Final Spin	Low Spin (500 rpm)	
Fluff	Tumble	
Rinse & Spin Cycle		
	Activity	Water Temperatures
Rinse	Fill & Tumble	Warm or Cold
Spin	Pulse Spin	
Spin	Medium Spin (650 rpm)	
Final Spin	High Spin (1000 rpm)	
Fluff	Tumble	

NOTE: The Rinse setting will give a cold rinse when the optional Extra Rinse is selected.

Common Washer Sounds

Sounds	Cause
Accelerating	This sound is heard during the spin portion of every cycle.
Tapping	These sharp sounds may come from metal fasteners, zippers, belt buckles or coins hitting the wash drum or door glass.
Thumping	Washer may be out of balance. Washer is designed to balance the load. If the washer is severely unbalanced, turn cycle selector knob to OFF and redistribute the load.
Rumbling	Washer may not be level. Stop washer and adjust leveling legs. Refer to INSTALLATION INSTRUCTIONS for details.



Using Your Dispenser Drawer

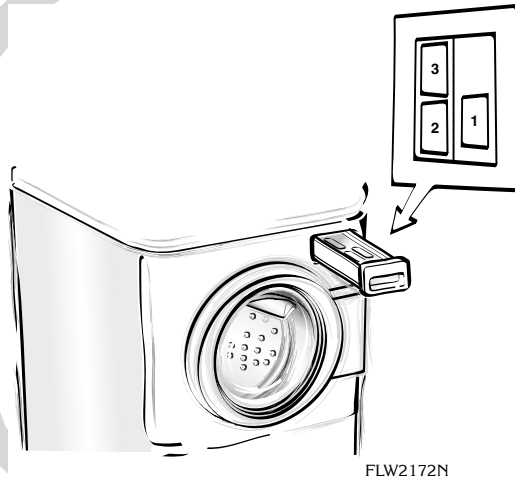

- 1 Detergent
- 2 Bleach
- 3 Fabric Softener

Detergent Compartment

The detergent compartment is located on the right side of the dispenser drawer. Refer to compartment 1 of illustration.

Use low sudsing, high efficiency (HE) powdered or liquid detergents that are recommended for use with frontload washers. Powdered bleach can also be used in the dispenser along with the detergent.

NOTE: High efficiency (HE) detergents are designed especially for frontload washers to reduce oversudsing and maximize cleaning results. Look for the HE logo or “high efficiency” on the detergent’s label.



NOTE: If using non-HE detergent, avoid oversudsing by using only 1/2 of the detergent manufacturer's recommended amount.

When adding detergent, use only the recommended amount. Adding too much detergent or using regular sudsing detergent could result in an oversudsing condition, which would require additional rinsing with cold water. Use care when adding detergent so as not to spill into the other compartments. Detergent mixed with fabric softener can make the softener gummy.

NOTE: The normal level of suds should be below center of the door.

Liquid Bleach Compartment

The bleach compartment is located in the left front corner of the dispenser drawer. Refer to compartment 2 of illustration. It has been designed to prevent the dispensing of undiluted bleach onto the clothes load.

Use liquid bleach in the dispenser. **Powdered bleach must not be used in this compartment. Powdered bleach can be used in the detergent compartment only and can be added along with the detergent.**

DO NOT use more than the maximum level indicated for the bleach compartment. Adding more than the maximum amount could result in early dispensing of the product and possible damage to fabrics.

Carefully pour recommended amount of bleach into the compartment before starting wash load.

Be careful not to spill undiluted bleach. It is a strong chemical and can damage some fabrics if it is not properly diluted. Follow bleach manufacturer's label for proper use.

Carefully close dispenser door. Do not allow bleach to spill into other compartments.

Fabric Softener Compartment

The fabric softener compartment is located in the left rear corner of the dispenser drawer. Refer to compartment 3 of illustration.

Use no more than the maximum level indicated for the fabric softener compartment. Adding more than the maximum amount could result in early dispensing of the product and possible staining of fabrics.

Add fabric softener to compartment before beginning wash load. The fabric softener will be dispensed during the last rinse cycle.

Carefully close dispenser door. Do not allow softener to spill into other compartments.

To Clean the Dispenser

Pour hot water into the dispenser drawer, making sure it flushes through each compartment. Use a small brush to thoroughly clean out any residue.

It is not necessary to remove the dispenser drawer for normal maintenance. If the dispenser drawer needs to be removed for any reason, use dispenser drawer removal tool, Part No. 318P4, to avoid damage to the drawer.



Clothing Care

Clothing Concerns

To keep clothes looking white or bright, use good washing practices at all times to prevent a gradual build-up of soil or water hardness minerals on them. If you notice that your clothes are not as bright as they should be, take corrective measures immediately.

Problem	Cause	Solution
Gray or Dingy Clothes	Insufficient Detergent	Add recommended amount of low-sudsing detergent to dispenser drawer before loading clothes. Mild detergents are not suitable for average soil.
	Improper Sorting	Wash whites separately. Separate light from heavily soiled items. Clothes can pick up soil from dirty wash water.
	Water Not Hot Enough	White clothes will stay whiter with hot wash water. Increase temperature.
Yellowed Clothes	Unremoved Soil	Skin soil is hard to remove. Check hem edge of sheets and pillowcases, bottom end of t-shirts, etc. If this portion is white and center is yellow, the fabric contains unremoved soil. Use sufficient detergent and a hot wash. Chlorine bleach or powered bleach may be needed.
	Clothes Stained from Iron in the Water	To test for an iron stain, use a rust remover that is recommended for use with washing machines on a portion of the garment. Follow bottle directions for larger items.
	Older Clothes	Some white fabrics turn yellow with age and cannot be whitened.
Clothes Tearing or Damaged	Improper Use of Chlorine Bleach	No correction for bleach damaged clothes. Always keep level at or below maximum in bleach dispenser compartment.
	Insufficient Precare	Fasten all hooks and zippers. Mend tears. Remove objects from pockets.
Excessive Lint	Improper Sorting	Fabrics that shed lint cannot be washed with fabrics that receive lint.
	Insufficient Detergent	Use enough detergent so lint remains suspended in water and flushed out. Do not oversuds the water.
	Mixing Fabric Types	Knits and permanent press attract lint. Wash these only with similar items. Use fabric softener in dispenser drawer.

Problem	Cause	Solution
Wrinkling	Improper Sorting	Heavy items like towels should not be washed with light items like nightgowns.
	Improper Cycle	Make sure cycle selected is appropriate for type of clothes.
	Improper Temperature	Using a warm or cold wash and a cold rinse reduces wrinkling.



Maintenance

Lubrication

- All moving parts are sealed in a permanent supply of lubricant or are equipped with oilless bearings. Additional lubrication will not be necessary.
- Do not lubricate the door hinge. If the hinge makes noise, replace the hinge.

Cold Weather Care

- If the washer is delivered on a cold day (below freezing), or is stored in an unheated room or area during the cold months, do not attempt to operate it until the washer has had a chance to warm up.

Care of Your Washer

- Use only a damp or sudsy cloth for cleaning the control panel. Some spray pretreat products may harm the finish on the control panel or damage the interior of the hood.
- Wipe the washer cabinet as needed. If detergent, bleach or other washing products are spilled on the cabinet, wipe immediately. Some products will cause permanent damage if spilled on the cabinet.
- Do not use scouring pads or abrasive cleansers.
- The wash drum and window will need no particular care although they may need rinsing or wiping after an unusual load has been washed.
- The outside of the door window can be cleaned with household window cleaner.
- Running an occasional rinse cycle with bleach will help to avoid a musty smell in the wash drum.

Cleaning Glass Sealing Area

In order to assure that the door properly seals against water leaks, the following surfaces should be wiped off periodically:

- The outside perimeter of the door glass where the seal contacts the glass
- The front surface of the door seal lip

Usually a mild soap solution will work. If there is an extreme build-up of minerals from a hard water supply, the surfaces may need to be cleaned with a lime removal chemical.

Replacing Hoses

- Hoses and other natural parts deteriorate after extended use. Hoses may develop cracks, blisters or material wear from the temperature and constant high pressure they are subjected to.
- All hoses should be checked on a monthly basis for any visible signs of deterioration. Any hose showing the signs of deterioration listed above should be replaced immediately.
- All hoses should be replaced every five years.

Filter Screens

- Check the filter screens in the fill hoses for debris or damage annually. Clean or replace them if necessary.
- If the washer is filling with water slower than normal, check the filter screens. Clean or replace them if necessary.
- Order filter screen Part No. F270300 from the nearest authorized parts distributor.

Vacations and Extended Non-Use

- To avoid possible property damage due to flooding, turn off the water supply to the washer whenever there will be an extended period of non-use.
- Leave the loading door open during extended periods of non-use to allow the wash drum to dry out and avoid a musty smell.

Reinstallation of Shipping Materials

To prevent damage while moving the unit, the shipping materials **MUST** be reinstalled.

- Disconnect washer from electrical supply.
- While supporting the front access panel, remove two screws from the bottom edge of the panel.
- Gently lower the panel to remove it from the washer.
- Place the shock sleeves on all four shock absorbers. Refer to the illustration below.
- Insert hooked end of shipping brace into the open slot of the motor mount.
- Attach the brace with the five bolts and washers. Refer to the illustration below.
- Reinstall front access panel.

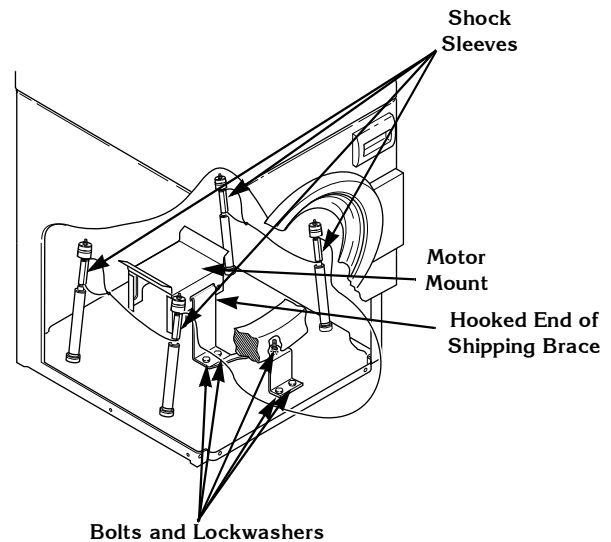

FLW2182N

Refer to the **INSTALLATION INSTRUCTIONS** for proper procedures whenever the washer is moved.

Cleaning Foreign Object Trap

The washer's pump has a trap that may collect foreign objects. The trap may need to be cleaned if water is draining slower than usual. To clean:

- Disconnect washer from electrical supply.
- While supporting the front access panel, remove two screws from the bottom edge of the panel.
- Gently lower the panel to remove it from the washer.

NOTE: The pump may have some water in it. Use a rag or a container to catch water. If the wash drum is full of water, use a wet/dry shop vacuum to catch the water.

- With rag or vacuum ready, unscrew the cap on the left side of the pump and remove trap.
- Clean the debris from the trap.
- Reinstall the trap and access panel.
- Reconnect washer to electrical supply.



Preventative Maintenance

Follow these guidelines to ensure the washer operates properly. Call for service if you observe any of the following: water of any amount on the floor; an increase in operating noise or water remaining in the wash basket after a cycle.

Frequency	Maintenance Procedure
Monthly	<ol style="list-style-type: none">1. Check all hoses and the drain for leaks.2. Check the door lock for proper operation.3. Clean the dispenser drawer. Refer to <i>Using Your Dispenser Drawer</i>.4. Check to make sure the washer is level.
Every six months	<ol style="list-style-type: none">1. Clean the filter screens in the fill hoses.2. Clean the door gasket with a bleach and water solution.
Every five years	Have a qualified service technician conduct general preventative maintenance on the washer to ensure it operates properly.

Control Knob Inserts

Your unit has come equipped from the factory with a red background on the control panel knobs. If you wish to change the color, additional color inserts are included in the accessories bag with your unit.

NOTE: A protective film has been applied to the color inserts that have been shipped in the accessories bag. To obtain the best appearance, remove film before installing inserts.

To add a color insert to the control panel knobs:

1. Pull knob off control panel.
2. Remove and save screws from back side of knob.
3. Pull off red rear piece from knob.
4. Place desired color insert on top of rear piece, over the two pegs, making sure flat area of insert lines up with notch on rear piece. Refer to illustration.
5. Place rear piece onto front part of knob.
6. Screw knob together with screws removed in step 2.
7. Reattach knob to control panel.

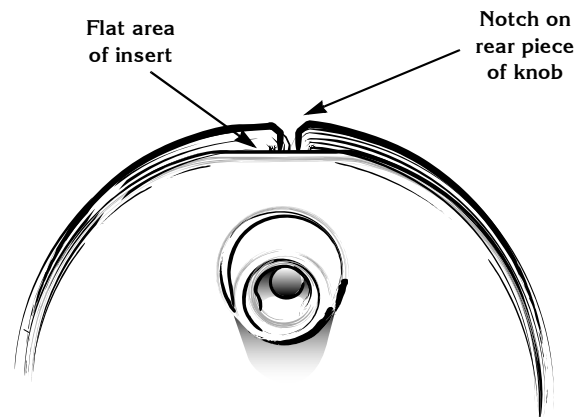

DRY2236N

Troubleshooting

Try these troubleshooting tips before making a service call. You may save time and money!

Washer Symptom	Possible Cause / Solution
Won't Fill	<ul style="list-style-type: none"> • Make sure power cord is plugged all the way into the electrical outlet. • Make sure hot and cold water faucets are turned on. • Make sure that the fill hoses are not kinked or twisted. • Turn the start knob to the right to start washer. • Make sure that the controls are properly set. • Make sure that the loading door is closed tightly. • Check the house fuse or circuit breaker. • Clean the screens in the water mixing valve and the filter screens located at the faucet end of the fill hoses. (Owner is responsible for service calls regarding cleaning of the screens.)
Won't Start	<ul style="list-style-type: none"> • Make sure loading door is closed tightly. • Turn the start knob to the right to start washer. • Make sure power cord is plugged all the way into the electrical outlet. • Make sure cycle selector knob is not set to the OFF position. • Check the house fuse or circuit breaker • Make sure door latch is properly adjusted relative to door lock.
Won't Spin/Tumble	<ul style="list-style-type: none"> • Make sure loading door is closed tightly. • Turn the start knob to the right to start washer. • Make sure power cord is plugged all the way into the electrical outlet. • Make sure controls are properly set. • Check the house fuse or circuit breaker. • Broken drive belt. Call the service person. • Foreign object trap in pump may be clogged. Clean the trap. Refer to <i>Maintenance</i> section.
Stops/Pauses During Cycle	<ul style="list-style-type: none"> • Pauses are part of the washer's normal operation. • Wash load may be unbalanced. Washer will stop and then restart spin automatically. If the washer is severely unbalanced, turn cycle selector knob to OFF and redistribute the load. • Check the house fuse or circuit breaker.
Won't Drain	<ul style="list-style-type: none"> • Make sure drain hose is not kinked or twisted. • Make sure drain hose is not clogged. • Make sure drain receptacle is not clogged. • Refer to the Installation Instructions to make sure that the drain hose has been properly installed. • Foreign object trap in pump may be clogged. Clean the trap. Refer to <i>Maintenance</i> section.
Water Leaks	<ul style="list-style-type: none"> • Check that fill hoses are properly installed on the faucets and the washer's water mixing valve. • Check the condition of the fill hoses. Replace fill hoses every five years. • Check the condition of the rubber door gasket for tears or holes. • Make sure drain receptacle is not clogged. • Check house plumbing. • Laundry load may be oversudsing or overloaded. Make sure you are using low-sudsing, high efficiency (HE) detergent and proper load sizes. • Make sure outside perimeter of the door glass where seal contacts glass is clean.

continued

Washer Symptom	Possible Cause / Solution
Too Many Soap Suds	<ul style="list-style-type: none"> • Laundry load may be oversudsing. Make sure you are using low sudsing, high efficiency (HE) detergent. • Make sure you are using the amount of detergent recommended on the detergent's label. If using non-HE detergent, use only 1/2 of the detergent manufacturer's recommended amount. • Laundry load may be overloaded. Make sure you are using proper load sizes.
Vibrates/Moves Slightly	<ul style="list-style-type: none"> • Make sure washer is level. Uneven leveling can cause vibration. • Make sure washer is installed on a solid, sturdy and level floor. The washer should not be installed on carpeting, soft tile, a platform or other weakly supported structures. • Make sure rubber feet are installed on all four leveling legs. • Try placing the washer near a corner of the room or near an external structural support wall.
Is Noisy	<ul style="list-style-type: none"> • Make sure washer is level. Uneven leveling can cause vibration. • Some sounds may be a part of normal operation for a frontload washer. Refer to <i>Common Washer Sounds</i> section.
Load is too Wet	<ul style="list-style-type: none"> • Wash load may be unbalanced. The washer may have limited the spin speed to prevent damage to the machine. Redistribute the load and run a RINSE & SPIN cycle. • Load is too small. Add items to make full load.
Wrong Water Temperature	<ul style="list-style-type: none"> • Make sure that the controls are properly set. • Check fill hoses. Make sure hot faucet hose is connected to hot mixing valve (indicated with "H" on the valve bracket) and cold faucet is connected to cold mixing valve (indicated with "C" on the valve bracket). • Make sure house water heater is adjusted properly.

Contact Information

If service is required, contact the nearest Factory Authorized Service Center. To find the nearest service center, visit us online at www.speedqueen.com.

If you are unable to locate an authorized service center or are unsatisfied with the service performed on your unit, contact:

Speed Queen
Shepard Street
P.O. Box 990
Ripon, Wisconsin 54971-0990
www.speedqueen.com
Phone: (920)748-3121

Date Purchased _____

Model Number _____

Serial Number _____

When contacting us about your washer, PLEASE GIVE THE MODEL AND SERIAL NUMBERS. The model and serial numbers are located on the nameplate. The nameplate will be in the location shown. Please include a copy of your bill of sale and any service receipts you have.

If replacement parts are required, contact the source from where you purchased your washer or visit us online at www.speedqueen.com.

	<h3>WARNING</h3>
<p>To reduce the risk of serious injury or death, DO NOT repair or replace any part of the washer or attempt any servicing unless specifically recommended in the user-maintenance instructions or in published user-repair instructions that you understand and have the skills to carry out.</p>	
<small>W025</small>	

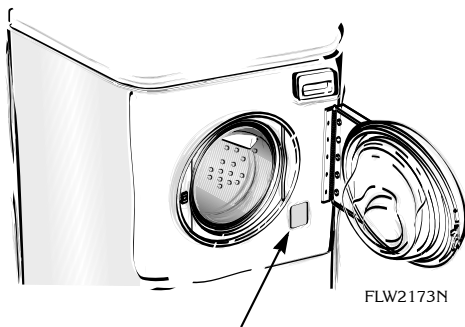

**Model Number and
Serial Number**

