



Standard Features & Accessories

All models include

- Downdraft blower systems are designed to exhaust airborne contaminants when cooking with gas or electric cooktops. They can be mounted in island, peninsula, or conventional wall locations.
- Hidden operation—mechanically raises and lowers from countertop with the touch of a button
- When not in use, unite retracts and rests flush with the cooking surface
- Suitable for both island and wall installations
- Choose from interior- or exterior- power ventilators (see **Installation Notes & Accessories**)
- Filter alert (flashing light) reminds you to clean filters after approx. 30 hours of use
- Four variable fan speeds ensure efficient ventilation
- Delay/off feature allows operation for 10 minutes before automatically shutting off
- Two removable, easy-to-clean mesh filters are dishwasher-safe and sized

VIPR models include

- For use with Viking Professional cooktops
- Controls on intake top

VIPR(R) models include

- For use with Viking Professional cooktops & rangetops* (non-grill, non-wok**)
- Island rangetop must be installed with island trim
- Remote-mounted control installs on the countertop prevents you from having to reach over cooking surface or vessels

DIPR models include

- For use with Viking Designer cooktops & rangetops (non-grill, non-wok**)
- Island rangetop must be installed with island trim
- Remote-mounted control installs on the countertop prevents you from having to reach over cooking surface or vessels

Model numbers

PROFESSIONAL DOWNDRAFT

VIPR101 – 30"W. (fits in most 30"W. cabinets*)

VIPR161 – 36"W. (fits in most 36"W. cabinets*)

VIPR181 – 48"W. (fits in most 48"W. cabinets*)

PROFESSIONAL DOWNDRAFT W/REMOTE

VIPR101R – 30"W. (fits in most 30"W. cabinets*)

VIPR161R – 36"W. (fits in most 36"W. cabinets*)

VIPR181R – 48"W. (fits in most 48"W. cabinets*)

DESIGNER DOWNDRAFT W/REMOTE

DIPR100R – 30"W. (fits in most 30"W. cabinets*)

DIPR160R – 36"W. (fits in most 36"W. cabinets*)

DIPR150R – 45"W. (fits in most 45"W. cabinets*)

*Remote model **must** be used when installed with VGRT rangetops.

**If installed behind a gas char-grill or wok, the warranty will be voided and performance may be below expectations. When selecting the power and high performance of a Viking gas char-grill or wok, a Viking 18"H. overhead hood is highly recommended.

Model Options



**VIPR Professional
Downdraft**

FINISH DETAILS FOR ALL MODELS

- Stainless Steel (SS)



**VIPR Professional
Downdraft w/Remote**

FINISH DETAILS FOR REMOTE MODELS

- Stainless Steel (SS)
- Black control panel and membrane with stainless steel trim
 - 4"W. x 2-1/2"D.



**DIPR Designer
Downdraft w/Remote**



★ Please see Installation Notes & Accessories for important information, including blower kits and remote mounted controls.

Dimensions & Specifications

PRODUCT DIMENSIONS



VIPR Professional Downdraft



VIPR Professional Downdraft w/Remote



DIPR Designer Downdraft w/Remote

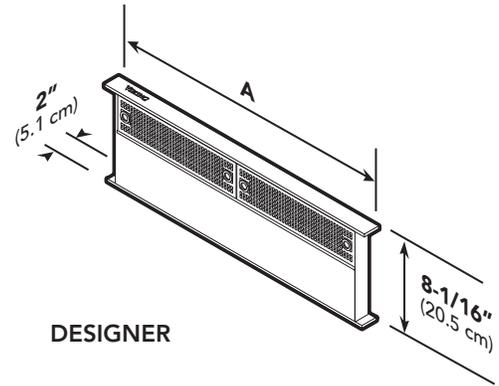
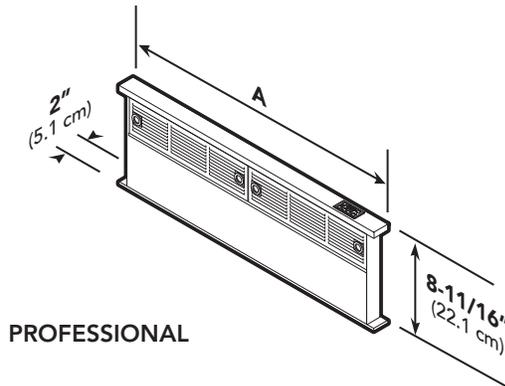

	VIPR101/101R	VIPR161/161R	VIPR181/181R	DIPR100R	DIPR160R	DIPR150R
Overall width (A)	30" (76.2 cm)	36" (91.4 cm)	48" (121.9 cm)	30" (76.2 cm)	36" (91.4 cm)	45" (114.3 cm)
Overall depth	2" (5.1 cm)					
Overall height	29-5/16" (74.5 cm)					
From countertop	8-11/16" (22.1 cm)	8-11/16" (22.1 cm)	8-11/16" (22.1 cm)	8-1/16" (20.5 cm)	8-1/16" (20.5 cm)	8-1/16" (20.5 cm)
Approx. ship. wt.	43 lbs. (19.4 kg)	50 lbs. (22.5 kg)	66 lbs. (29.7 kg)	43 lbs. (19.4 kg)	50 lbs. (22.5 kg)	66 lbs. (29.7 kg)



Dimensions & Specifications

CLEARANCE DIMENSIONS

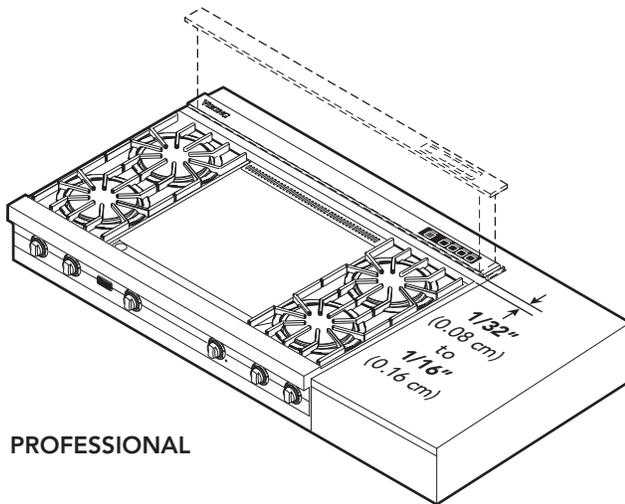
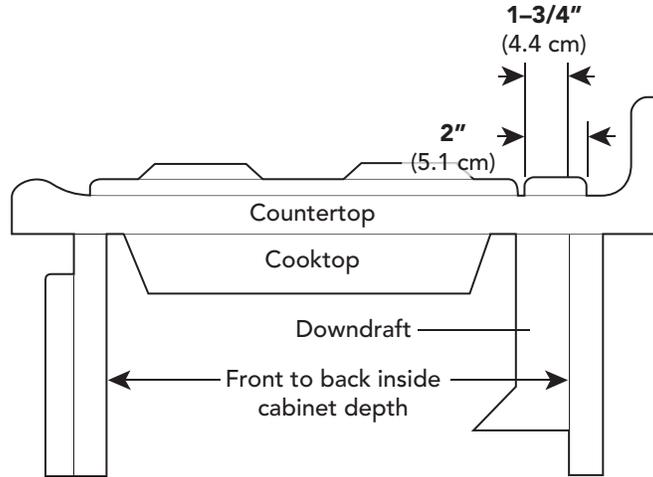

PROFESSIONAL

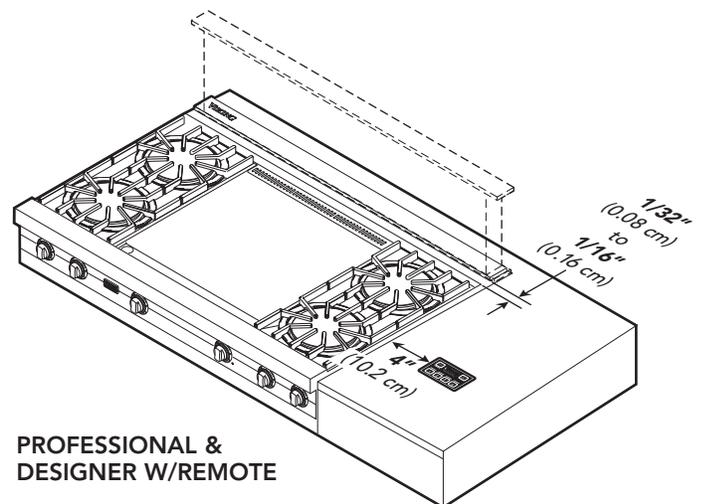

PROFESSIONAL & DESIGNER W/REMOTE

Note: Accurate alignment of cooktop and downdraft is necessary to ensure that there is no interference when air vent is raised and lowered. There should be a gap of 1/32"–1/16" (.08 cm–0.16 cm) between the back of the cooktop and the front of the downdraft cover. Rangetops and Designer cooktops must be used with an "R" model downdraft (with remote control) - mounted into the countertop, at least 4" (10.2 cm) from the burners.

Countertops with a raised lip and/or backsplash may not allow enough flat space. Installation requires 2" of flat countertop behind the cooking surface, and 1-3/4" between the back edge of the cooking surface and the inside back of cabinet. (Viking recommends that oversized cabinets be used for easier installation. Also, cooktop depth can vary greatly, causing the fit of cooktop/rangetop and downdraft to be tight.)

The remote mounted control (if

applicable) must be placed in the countertop. Do not install it directly behind or beside a burner or element. Distance between the controls and the edge of the cooking surface should be 4" min.

Important—If installing in a cabinet with same width as your downdraft model, the outlet cannot be located on the back wall of cabinet. In these cases, the downdraft will cover the entire back wall of the cabinet, so you must you must either

- mount the electrical box to a side wall or

cabinet floor—at least 12" from the back wall, or

- mount the electrical box to a wall stud behind the cabinet, where it will not be covered by the downdraft, and provide a clearance hole in the back wall of the cabinet.

For ducting clearance, check location of floor joists, wall studs, electrical wiring or plumbing for possible interference.



Installation Requirements



**VIPR Professional
Downdraft**



**VIPR Professional
Downdraft w/Remote**



**DIPR Designer
Downdraft w/Remote**

UTILITY REQUIREMENTS



DUCTING

- Check with a qualified and trained installer or local codes for makeup air requirements, if any.
- Max. duct run length (see **Installation Notes & Accessories**)
- For best performance, use the shortest length of ductwork and a minimum number of elbows.
- The system will operate most efficiently when the ductwork does not exceed 40' of equivalent duct. For longer duct runs, increase duct size and contact a qualified and trained installer.
- Straight runs and gradual turns are best; for example, each 90° elbow is equivalent to 5' – 10' (152.4 – 304.8 cm) of straight run.

- 6" or 10" round elbow= 6' of straight duct
- 3-1/4" x 10" to 6" round transition= 2' of straight duct
- 3-1/4" x 10" 90° elbow= 8' of straight duct
- Never use flexible duct; it creates back pressure/air turbulence and greatly reduces performance.



GAS

- Not applicable



ELECTRICAL

- 2'-long power cord with 3-pronged plug included
- Internal blowers require a grounded outlet within reach of the power cord
- External blowers require direct



PLUMBING

- Not applicable

- hardwiring with 2-wire with ground, using locally-supplied wire, and connected to the downdraft plug (included)
- 120 VAC/60 Hz
- Max. amp usage (rating does not include recommended ventilator kit rating—See **Installation Notes & Accessories**)

Model	Ventilator Kits		Duct Size		Max. Amps	
	Interior	Exterior	Interior	Exterior	Interior	Exterior
VIPR101	VIDV500	VEDV900	3-1/4" x 10" (8.3 x 25.4 cm)	10" (25.4 cm)	4.0	5.7
VIPR161	VIDV500	VEDV900	3-1/4" x 10" (8.3 x 25.4 cm)	10" (25.4 cm)	4.0	5.7
VIPR181	VIDV500	VEDV900/1200	3-1/4" x 10" (8.3 x 25.4 cm)	10" (25.4 cm)	4.0	5.7/3.0
VIPR101R	VIDV500	VEDV900	3-1/4" x 10" (8.3 x 25.4 cm)	10" (25.4 cm)	4.0	5.7
VIPR161R	VIDV500	VEDV900	3-1/4" x 10" (8.3 x 25.4 cm)	10" (25.4 cm)	4.0	5.7
VIPR181R	VIDV500	VEDV900/1200	3-1/4" x 10" (8.3 x 25.4 cm)	10" (25.4 cm)	4.0	5.7/3.0
DIPR100R	VIDV500	VEDV900	3-1/4" x 10" (8.3 x 25.4 cm)	10" (25.4 cm)	4.0	5.7
DIPR160R	VIDV500	VEDV900	3-1/4" x 10" (8.3 x 25.4 cm)	10" (25.4 cm)	4.0	5.7
DIPR150R	VIDV500	VEDV900	3-1/4" x 10" (8.3 x 25.4 cm)	10" (25.4 cm)	4.0	5.7

Note: Proper installation/ ducting is extremely important to ensure maximum performance. Use a qualified and trained installer.



Installation Requirements

PROFESSIONAL ACCESS REQUIREMENTS & SITE PREPARATION

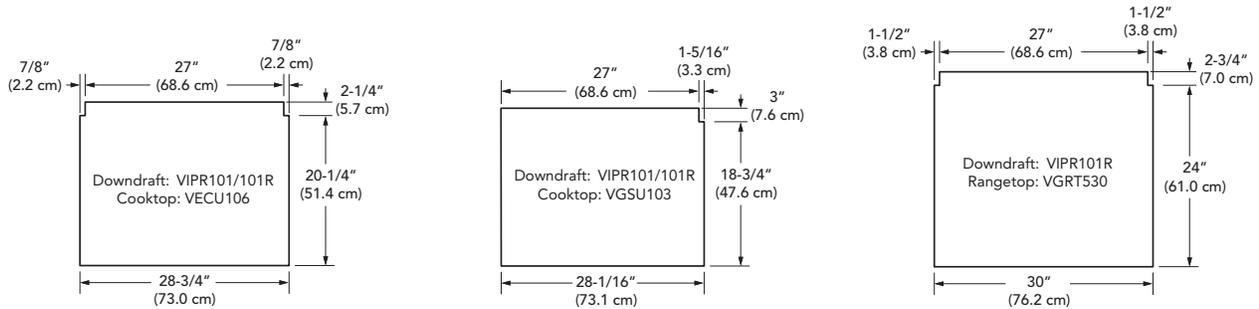

VIPR101/101R

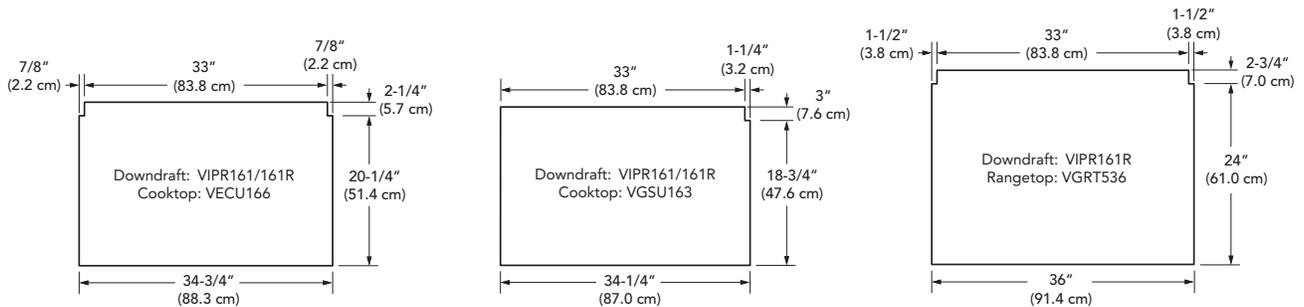

VIPR161/161R

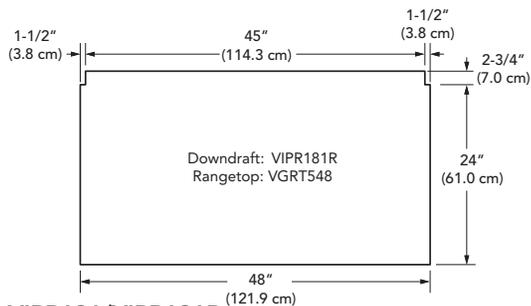

VIPR181/VIPR181R

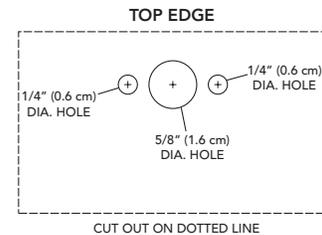

REMOTE CONTROL CUTOUT

Model	Downdraft Cutout		Cooktop Cutout	
	Width	Depth	Width	Depth
VIPR101/101R				
w/VECU106	27" (68.6 cm)	2-1/4" (5.7 cm)	28-3/4" (73.0 cm)	20-1/4" (51.4 cm)
w/VGSU103	27" (68.6 cm)	3" (7.6 cm)	28-1/16" (73.1 cm)	18-3/4" (47.6 cm)
w/VGRT530*	27" (68.6 cm)	2-3/4" (7.0 cm)	30" (76.2 cm)	24" (61.0 cm)
VIPR161/161R				
w/VECU166	33" (83.8 cm)	2-1/4" (5.7 cm)	34-3/4" (88.3 cm)	20-1/4" (51.4 cm)
w/VGSU163	33" (83.8 cm)	3" (7.6 cm)	34-1/4" (87.0 cm)	18-3/4" (47.6 cm)
w/VGRT536*	33" (83.8 cm)	2-3/4" (7.0 cm)	36" (91.4 cm)	24" (61.0 cm)
VIPR181/VIPR181R				
w/VGRT548*	45" (114.3)	2-3/4" (7.0 cm)	48" (121.9 cm)	24" (61.0 cm)

*Must use island trim. Rear countertop trim (supplied with island trim) will be used in this installation.



Installation Requirements

DESIGNER ACCESS REQUIREMENTS & SITE PREPARATION

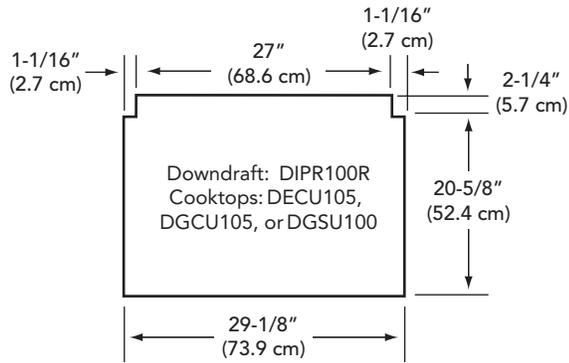

DIPR100R

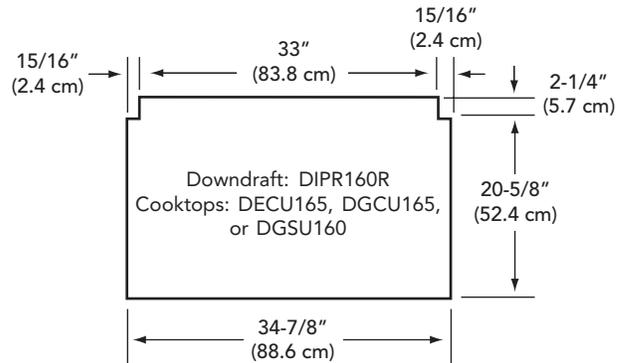

DIPR160R

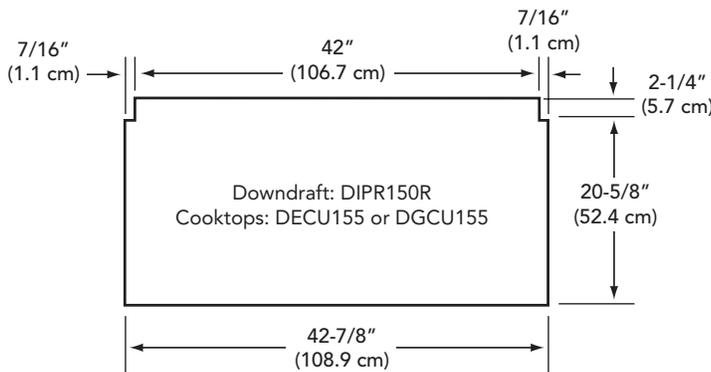

DIPR150R

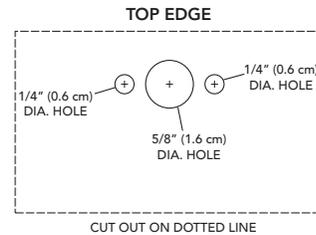

REMOTE CONTROL CUTOUT

Model	Downdraft Cutout		Cooktop Cutout	
	Width	Depth	Width	Depth
DIPR100R				
w/DECU105	27" (68.6 cm)	2-1/4" (5.7 cm)	29-1/8" (73.9 cm)	20-5/8" (52.4 cm)
w/DGCU105	27" (68.6 cm)	2-1/4" (5.7 cm)	29-1/8" (73.9 cm)	20-5/8" (52.4 cm)
w/DGSU100	27" (68.6 cm)	2-1/4" (5.7 cm)	29-1/8" (73.9 cm)	20-5/8" (52.4 cm)
DIPR160R				
w/DECU165	33" (83.8 cm)	2-1/4" (5.7 cm)	34-7/8" (88.6 cm)	20-5/8" (52.4 cm)
w/DGCU165	33" (83.8 cm)	2-1/4" (5.7 cm)	34-7/8" (88.6 cm)	20-5/8" (52.4 cm)
w/DGSU160	33" (83.8 cm)	2-1/4" (5.7 cm)	34-7/8" (88.6 cm)	20-5/8" (52.4 cm)
DIPR150R				
w/DECU155	42" (106.7 cm)	2-1/4" (5.7 cm)	42-7/8" (108.9 cm)	20-5/8" (52.4 cm)
w/DGCU155	42" (106.7 cm)	2-1/4" (5.7 cm)	42-7/8" (108.9 cm)	20-5/8" (52.4 cm)



✦ Installation Notes & Accessories

Interior-Power Blower Kit

- Stainless Steel (SS)
- Mounts on any size plenum
- 3-1/4" x 10" duct takeoff
- Can transition to 6" round
- Can run duct to left, right, or down
- Max. duct run—40' (12.2 m)
- Kit includes motor, downdraft plug, and 3-1/4" x 10" collar (for installers who prefer to rivet the ductwork to the unit.)

Note: Exhaust capacity based on tests with 0.1 static pressure. Without applying static pressure (some brands do not), CFM could be greatly overstated

Model	Description	Max. amp usage	Approx. ship wt. lbs. (kg)
VIDV500	500* CFM downdraft blower	4.0	32 (14.4)

Exterior-Power Blower Kit

- Stainless Steel (SS)
- Mounts on wall or roof (no roof cap required)
- Comes with 10" round duct takeoff plate, which mounts on any size plenum
- Max. duct run—50' (15.2 m)
- Kit includes motor, downdraft plug, and 3-1/4" x 10" collar (for installers who prefer to rivet the ductwork to the unit.)
- VEDV1200 must be used with VIPR181/181R

Note: Exhaust capacity based on tests with 0.1 static pressure. Without applying static pressure (some brands do not), CFM could be greatly overstated

Model	Description	Max. amp usage	Approx. ship wt. lbs. (kg)
VEDV900	900 CFM downdraft blower	5.7	42 (18.9)
VEDV1200	1200 CFM downdraft blower	3.0	44 (19.8)

Remote Mounted Control

- Replaces standard Designer control
- Gray control panel and membrane with stainless steel trim—coordinates with white Designer cooktops
- Easy to install
- Must be mounted into the countertop, 4" min. from burners
- 4"W. x 2-1/2"D.

Model	Description	Approx. ship wt. lbs. (kg)
DSRCGY	Designer remote mounted control (SS/gray)	1.5 (0.7)

Compliance Information



WARRANTY SUMMARY*

- One-year full warranty—complete product
- Five-year limited warranty—all ventilator motors
- Ninety-day limited warranty—cosmetic parts such as glass, painted, and decorative items

*Must use Viking ventilator kits with Viking downdrafts; use of non-Viking kits voids product warranty. For complete warranty see *Use & Care Guide*. Warranty valid on Viking products shipped within the United States and Canada.

