

## MODULAR 3000 SERIES 120V, 3018CLR MODELS



**U-3018CLROL-00**

**U-3018CLROL-01**

**U-3018CLROL-40**

**U-3018CLROL-41**

**U-3018CLRS-00**

**U-3018CLRS-01**

**U-3018CLRS-40**

**U-3018CLRS-41**

## Introduction

Congratulations on your purchase of a U-Line refrigeration product.

For nearly five decades and three generations, U-Line continues to be the leader in innovation, quality and value in the premium built-in undercounter ice making, refrigeration and wine preservation market. U-Line has captivated those with an appreciation for the finer things with exceptional functionality, style, inspired innovation and attention to even the smallest details. We are known and respected for our unwavering dedication to product design, quality and selection.

In 1962, Henry Uihlein founded U-Line Corporation as an outgrowth of Ben-Hur Freezer Company and was the first to develop and patent an automatic stand-alone undercounter residential ice maker. His foresight and determination to develop new ideas and to succeed when there were no clear guidelines or solutions are evident today. The newest Uihlein generation continues to build upon the family's innovative legacy at the Milwaukee, Wisconsin based business by providing continuity and vision from which new designs and technology continue to be born.

Today the complete U-Line product collection includes Ice Makers, Wine Captain® Models, Combo® Models, a Refrigerator / Freezer, Refrigerators, Drawers and Beverage Centers. The U-Line brand offers products in the 1000 Series, 2000 Series and the Modular 3000 Series. The 1000 Series offers a more targeted priced product with appropriate features, while the 2000 Series offers upscale features, advanced technology and specialized product families. U-Line's approach to its breadth of products, multiple price points and features allows a choice and product that will fit any lifestyle.

## Read and save this Use and Care Guide.

### NOTICE

**READ all instructions in this guide completely before using the appliance for the first time.**

For future reference, keep this guide in a safe, accessible location. If you need additional information or assistance, please contact U-Line Corporation direct. Contact information appears on the back cover of this guide.

**Before Calling Service.** If you think your U-Line product is malfunctioning, read the OPERATION section of this guide to understand clearly the function of the control. If the problem persists, read the TROUBLESHOOTING GUIDE section of this guide to help you quickly identify common problems, and provide information on possible causes and remedies.

## Please Record Your Model Information

You will need your product model and serial number when you request additional information or services. You can find this information on the serial plate located on the upper right or back wall in the interior of your product. This information also appears on the warranty registration card. Please complete and mail your warranty registration card. You may also register online at [www.u-line.com](http://www.u-line.com)



Please record the model number (1), serial number (2), date of purchase, and dealer contact information for your U-Line product below:

**Model Number:**

---

**Serial Number:**

---

**Purchase Date:**

---

**Dealer Name:**

---

**Dealer Address:**

---

**Dealer Telephone:**

---

## Table of Contents

---

<b>1 - Safety Precautions</b>	
Safety Alert Definitions .....	1
General Precautions .....	1
<b>2 - Product Features</b>	
Guide Coverage .....	2
Model Features.....	2
3000 Series Features.....	2
<b>3 - Product Operation</b>	
Air Flow .....	3
Initial Startup.....	3
U-Select® Control .....	3
Customer Menu .....	3
Refresh Kit.....	7
Ice Cube Thickness Adjustment.....	7
<b>4 - 3000 Series Maintenance</b>	
Leveling.....	8
Removing and Installing Grille .....	8
Adjusting Grille.....	8
<b>5 - 3000 Series Doors</b>	
Door Alignment and Adjustment.....	9
<b>6 - Cleaning</b>	
Exterior Cleaning.....	10
Interior Cleaning.....	10
Clear Ice Maker Cleaning Cycle.....	10
Condenser Cleaning .....	12
Storage, Vacation and Moving .....	12
Product Disposal.....	12
<b>7 - Service</b>	
Before Calling for Service.....	13
If Service is Required.....	13
Replacement Parts.....	13
Normal Operating Sounds.....	13
Troubleshooting Guide .....	13

## I Safety Precautions

### NOTICE

- **PLEASE READ** all instructions before installing, operating, or servicing the appliance.
- Proper installation procedures must be followed when completing an installation or relocation of a unit. An **INSTALLATION GUIDE** for the unit, providing complete installation information, is available from U-Line Corporation direct. Consult the installation guide before any installation begins. U-Line contact information appears on the rear cover of this guide.
- This unit requires connection to a dedicated 15 Amp grounded (three-prong), polarized receptacle, installed by a qualified electrician, compliant with applicable electrical codes.

### Safety Alert Definitions

Throughout this guide are safety items labeled with a Danger, Warning or Caution based on the risk type:

#### **DANGER**

*Danger means that failure to follow this safety statement will result in severe personal injury or death.*

#### **WARNING**

Warning means that failure to follow this safety statement could result in serious personal injury or death.

#### **CAUTION**

Caution means that failure to follow this safety statement may result in minor or moderate personal injury, property or equipment damage.

### General Precautions

Use this appliance for its intended purpose only and follow these general precautions with those listed throughout this guide:

#### **DANGER**

**RISK OF CHILD ENTRAPMENT.** Before you throw away your old refrigerator or freezer, take off the doors and leave shelves in place so children may not easily climb inside.

#### **WARNING**

- **SHOCK HAZARD - Electrical Grounding Required.**
- Never attempt to repair or perform maintenance on the unit until the electricity has been disconnected.
- Never remove the round grounding prong from the plug and never use a two-prong grounding adaptor.
- Altering, cutting of power cord, removal of power cord, removal of power plug, or direct wiring can cause serious injury, fire and/or loss of property and/or life, and will void the warranty.
- Never use an extension cord to connect power to the unit.
- Always keep your working area dry.

#### **WARNING**

Install provided Anti-Tip kit on all 3000 series units. Serious personal injury could occur.

#### **CAUTION**

- Use care when moving and handling the unit. Use gloves to prevent personal injury from sharp edges.
- If your model requires defrosting, **DO NOT** use an ice pick or other sharp instrument to help speed up defrosting. These instruments can puncture the inner lining or damage the cooling unit. **DO NOT** use any type of heater to defrost. Using a heater to speed up defrosting can cause personal injury and damage to the inner lining.

### NOTICE

- Do not lift unit by door handle.
- Never install or operate the unit behind closed doors. Be sure front grille is free of obstruction. Obstructing free airflow can cause the unit to malfunction and will void the warranty.
- Failure to clean the condenser every six months can cause the unit to malfunction. This could void the warranty.
- Do not Block any internal Fans.

Use only genuine U-Line replacement parts. Imitation parts can damage the unit, affect its operation or performance and may void the warranty.

## 2 Product Features

### Guide Coverage

This guide covers the following list of models.

**U-3018CLROL-00**

**U-3018CLROL-01**

**U-3018CLROL-40**

**U-3018CLROL-41**

**U-3018CLRS-00**

**U-3018CLRS-01**

**U-3018CLRS-40**

**U-3018CLRS-41**

### Model Features

**High daily ice production and storage.** The 3018CLR produces up to 60 pounds of ice per day and stores up to 30 pounds.

**Electronic control module.** Automatically adjusts for changes in room and water temperatures to maximize ice production.

**Easy, self-cleaning process.** Models have a simple to use self cleaning process. Within one hour all ice making internal components have been thoroughly cleaned and rinsed.

**Flexible water drain options.** Water may be drained using either a gravity fed drain or a U-Line supplied P60 drain pump.

### 3000 Series Features

**Advanced OLED control system:** State of the art OLED control system display.

**Fully Integrated Design:** Units are designed to blend seamlessly with surrounding decor.

**Stainless Steel:** Stainless steel models offer a commercial stainless steel handle and door wrap.

**Overlay Models:** Overlay models accept a custom overlay panel or frame to achieve perfect symmetry with surrounding cabinetry.

**Fully Adjustable Toe-Kick / Grille:** Grille is fully adjustable and can be lined up with surrounding cabinetry toe kick height and depth for a truly built-in look.

**Adjustable Leg Levelers:** Heavy Duty leg levelers help dial in the perfect fit. Rear leg levelers are adjusted from the front of the unit for ease of installation.

**Advanced diagnostic system:** Advanced diagnostic systems accessible through front grille mounted USB port, an industry first.

**Advanced LED lighting system:** Energy efficient and low heat LED lighting provides an elegant illumination system. Theater style lights build to fully on and dim to fully off over a 3 second window. Fully programmable / adjustable.

**3 Product Operation**

**Air Flow**

**NOTICE**

The unit requires proper air flow to perform at its highest efficiency. Do not block the front grille, internal fans or vents at any time, or the unit will not perform as expected. Do not install the unit behind a door.

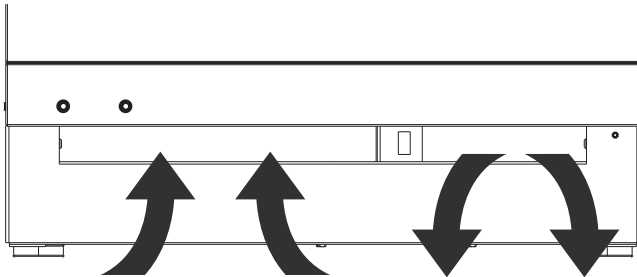

**Initial Startup**

All U-Line controls are preset at the factory. Initial start-up requires no adjustments.

To power your unit on simply press POWER and the unit will immediately switch on. To turn the unit off, press and hold POWER for 5 seconds and release. The display will show a countdown to switching the unit off.

**U-Select® Control**

**Digital Display**

The 3000 Series units are controlled by a feature rich, advanced OLED display control unit. The control panel allows adjustment to temperature set-point, access to Energy Saver Mode, internal temperature readings, and many other features.

**U-Select Lighting**

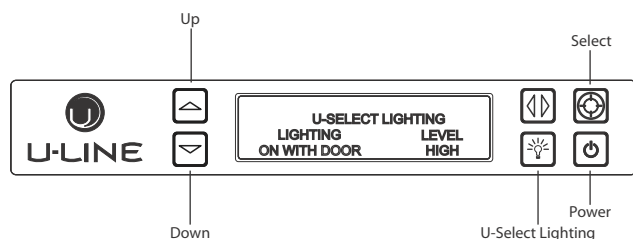

1. To begin, press U-Select Lighting to enter the lighting menu.
2. Use Up or Down to cycle through each available brightness setting; Low, Medium, or High.

3. Use U-Select Lighting to cycle through each available timer setting. Selections include “On With Door”, “On 3 Hours”, “On 6 Hours”, or “On 24 Hours”.
4. To exit, press Select or simply wait for the menu to time out.

**Customer Menu**

The 3000 Series of U-Line undercounter refrigeration appliances contain a feature rich customer menu. The Customer Menu allows access to a Series of advanced features including Energy Saver Mode, Sabbath mode, actual temperature readings as well as a method to restore factory defaults.

**3000 Series - Customer Menu**

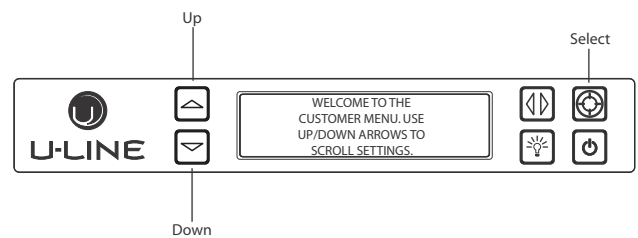

1. To access the Customer Menu hold Select for 5 seconds.
2. Use Up or Down to scroll through available selections.
3. Use Select to enter selected sub-menu.
4. To exit Customer menu, Use Down to scroll to the bottom of the display and use Select to Select “Exit.”

**Actual Temps**

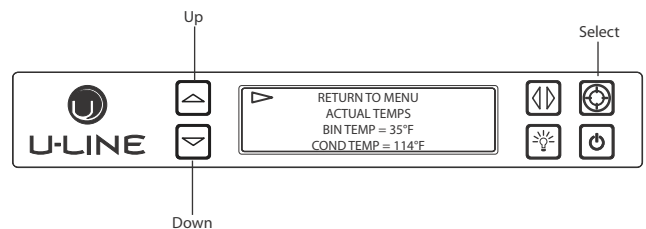





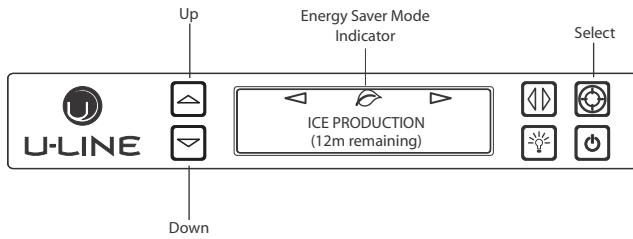

The Actual Temps option displays the actual temperature of the ice bin, condenser, as well as ambient temperature.

1. To view actual temperature, Select Actual Temps from the customer menu.
2. Use Up or Down to scroll through available information.
3. To return to the customer menu, Select Return to Menu.

### Energy Saver Mode





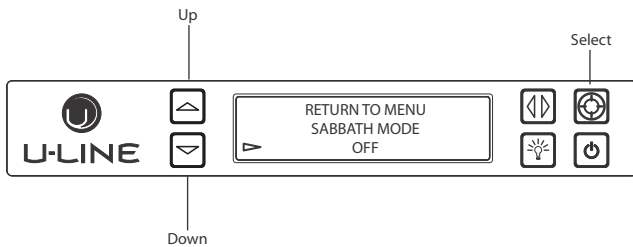

Energy Saver mode reduces overall energy consumption by reducing the amount of ice stored in the bin, along with decreasing the lighting.

1. To enter Energy Saver first select Energy Saver from the Customer Menu.
2. Use Down  to select “Off” in the menu.
3. Press Select .
4. Use Up  or Down  to change the selection from Off to On.
5. Press Select  to confirm your selection.
6. To return to the customer menu, Select  Return to Menu.
7. To cancel Energy Saver mode simply return to the Customer Menu, Select Energy Saver mode and change “On” to “Off”.

### Sabbath Mode



The U-line 3000 Series of models offer a Sabbath mode for users who require this functionality during Sabbaths. Sabbath mode disables system responses to user initiated activities and all external functions; including lighting, display and audible alarms. The unit will still maintain internal temperatures and set points.



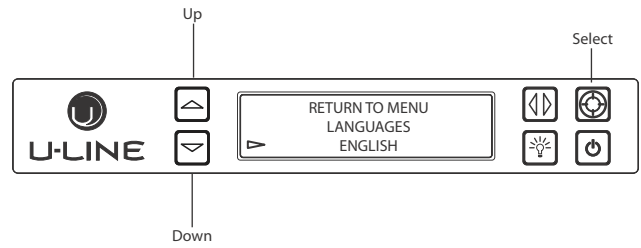

1. To enter Sabbath Mode, select Sabbath Mode from the Customer Menu.
2. Use Down  to select “Off”.
3. Press Select , “Off” will begin to flash.
4. Use Up  or Down  to change “Off” to “On”.
5. Press Select  to confirm your selection.

The Display will fade out as the unit enters Sabbath Mode. Sabbath Mode remains active until Power  is pressed.

### Languages



The U-Line 3000 Series of models supports a number of display languages including English, Spanish, French and German.





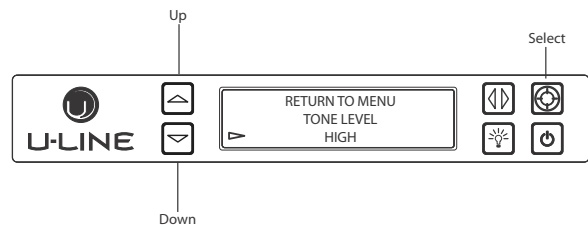

1. To change display language select Languages from the Customer Menu.
2. Use Down  to select “English”.
3. Press Select , “English” will begin to flash.
4. Use Up  or Down  to cycle through the available Languages.
5. Press Select  to confirm your choice.

### Tone Level



Audible alarms and alert tones support four different Tone Level settings, High, Medium, Low, and Off.



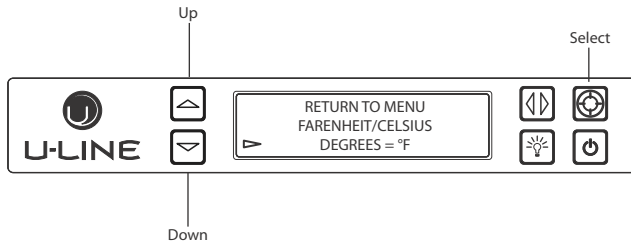

To select a new tone level, enter the Tone Level menu from the Customer Menu.

1. Use Up  or Down  to select the current tone level.
2. Press Select , the current setting will begin to flash.
3. Use Up  or Down  to select a different level.
4. Use Select  to confirm your choice.

**Fahrenheit / Celsius**

Temperature and Set point information can be displayed in either Fahrenheit or Celsius.

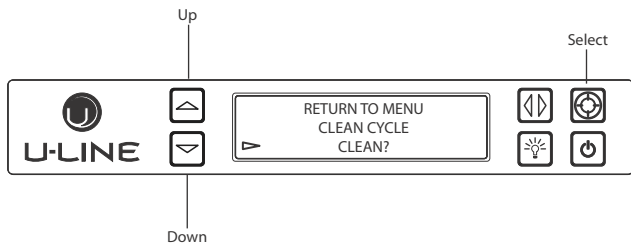

To change from Fahrenheit to Celsius enter the Fahrenheit / Celsius menu from within the Customer Menu.

1. Use Down  to select “Degrees”.
2. Press Select . The selection will begin to flash.
3. Use Up  or Down  to select between °F (Fahrenheit) or °C (Celsius).
4. Press Select  to confirm your choice.

**Clean Cycle**

A clean cycle can be initiated through this menu. Once the cleaning cycle starts, the cycle cannot be stopped until complete.

To initiate a clean cycle, enter the Clean Cycle in the Customer Menu. Please refer to CLEANING section regarding proper cleaning procedure.

1. Use Down  to select “Clean Cycle”.
2. Press Select . The clean cycle will now begin.
3. Refer to CLEANING section regarding proper cleaning procedure.

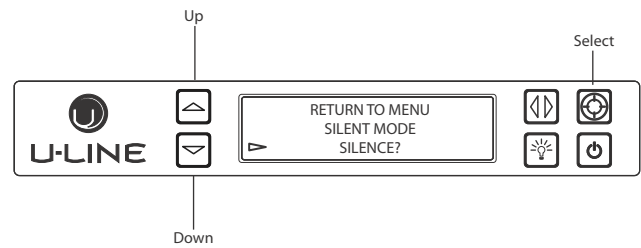

**Silent Mode**

Users can halt ice production for 3 hours with an option called “Silent Mode” in the Customer Menu. Silent Mode will begin once the current ice making cycle is complete. After 3 hours in Silent Mode, normal ice production will continue.



NOTE: Silent Mode will not silence any alerts.

To initiate Silent Mode, enter Silent Mode Menu from within the Customer Menu.

*Activating Silent Mode*

1. Use Down  to select “Silence?”.
2. Press Select . Silent Mode will now begin.

*Cancelling Silent Mode*



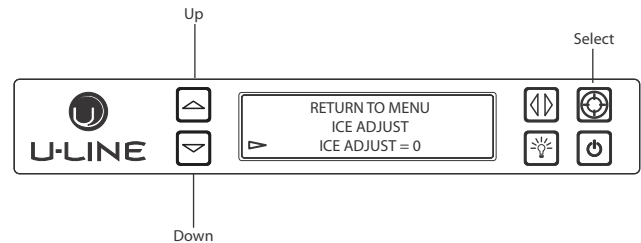

1. Use Down  to select “Cancel?”.
2. Press Select . Silent Mode will end.

**Ice Adjust**

The Ice Adjust option adjusts ice thickness by adding or subtracting up to 5 minutes of ice production.

To change the ice thickness, enter the Ice Adjust menu from within the Customer Menu.

*To adjust thickness*



1. Use Down  to select “Ice Adjust”.
2. Press Select . The selection will begin to flash.
3. Use Up  to make the ice thicker or Down  to make the ice thinner.
4. Press Select  to confirm your choice.

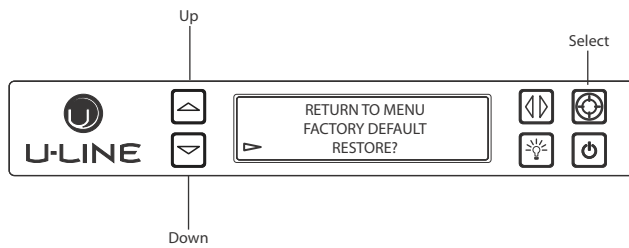



**Factory Default**

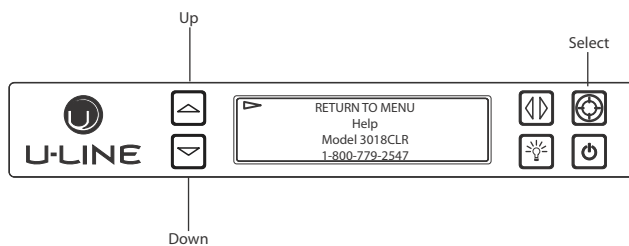

The Factory Default option restores all settings to the original settings the unit came with.

To restore Factory Default settings, enter the Factory Default menu from within the Customer Menu.

1. Use Down  to select "Restore?".
2. Press Select . All settings will now be at Factory Default.

**Help**

To access the Help menu select Help from the Customer Menu. Use Up  or Down  to scroll through available information.

To return to the customer menu, use Up  to select "Return to Menu" and press Select  to confirm.

**NOTICE**

- Discard all ice produced in the first harvest.
- Should power to the unit be interrupted during the self-clean cycle, the complete cleaning cycle will repeat after power is restored.

**Refresh Kit**

Due to variations in water quality or inadequate maintenance your unit may become excessively coated in lime scale or calcium. U-Line offers a cost effective refresh kit which replaces many interior components and will return your unit to like new condition. Refresh kits may be ordered from your local distributor and installed by your local service company. For information on your local distributor or service company please visit <http://www.u-lineservice.com>.

**Ice Cube Thickness Adjustment**

**Interval - As Required**

1. See Ice Adjust section (p. 5) of the U-Select Control chapter for directions on how to adjust ice thickness.

**NOTICE**

Ice thickness adjustment should only be made one increment at a time. Allow ice maker production to stabilize for 24 hours before rechecking ice thickness.

2. Remove all ice from the storage bin.

Ice cubes in any given batch will vary, so it is necessary to choose cubes from the sample area for comparison when making adjustments. If further adjustments are desired, repeat Steps 1 through 4.

The ice cube thickness is factory set for best overall performance. The factory setting is designed to maintain an ice bridge of approximately 1/16" to 1/8" under normal conditions, resulting in a dimple of approximately 1/4" to 1/2" in depth. A fuller cube with less of a dimple results in a thicker ice bridge. As the ice bridge thickens, the tendency for the cubes to stay together as a slab increases. A bridge thicker than 1/8" may cause cubes to overflow the ice bucket.

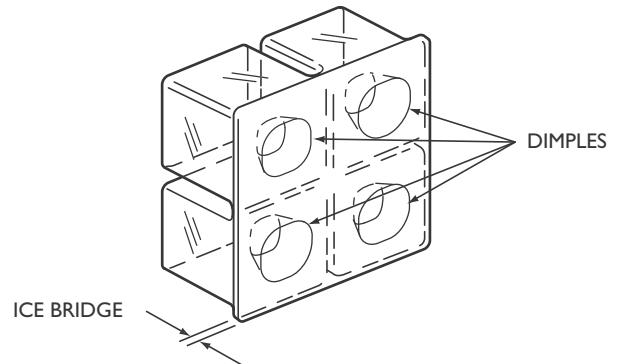

Ice Bridge and Dimples

Cube Types

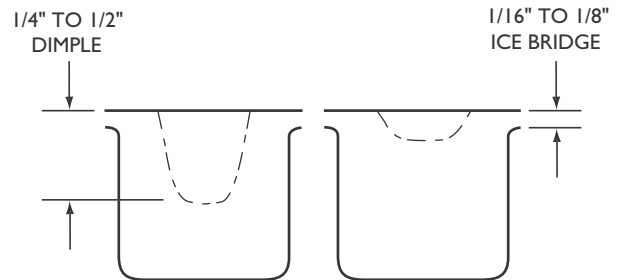

GOOD

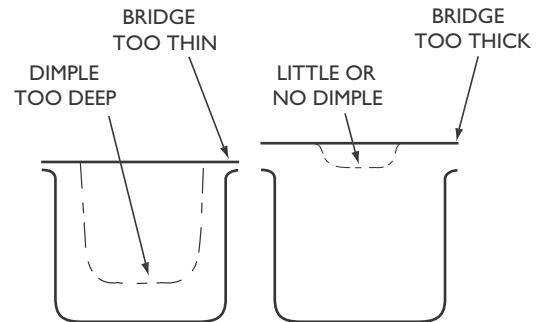

BAD

**4 3000 Series Maintenance**

**Leveling**

**NOTICE**

**Unit must be level for proper door and unit operation.**

1. Use a level to check the levelness of the unit from front to back and from side to side. Place the level along top edge and side edge as shown (1).
2. If the unit is not level, rotate the adjustable leveling legs to raise or lower each corner of the unit (2) as necessary.

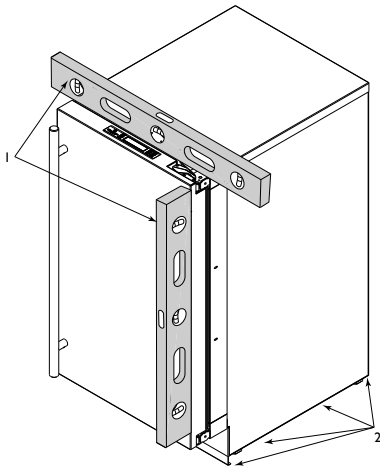

3. To rotate rear leveler legs remove grille. See Removing and Installing Grille.
4. Using the provided 6mm T bar allen wrench, rotate the 2 adjustment screws as shown below.

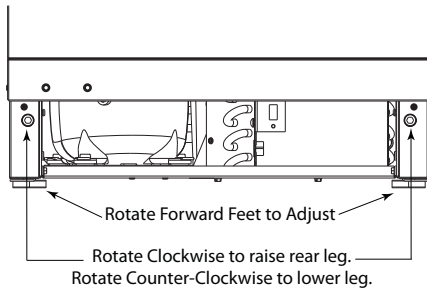

**CAUTION**

**Do not use a power tool to rotate the two adjustment screws. This can result in damage to the unit.**

5. Check levelness after each adjustment and repeat the previous steps until the unit is level.

**Removing and Installing Grille**

**WARNING**

- Disconnect electrical power to the unit before removing the grille.
- Edges of sheet metal may be sharp.

**Removing the grille.**

1. Disconnect power to unit.
2. Using the included 7/64" Allen wrench, loosen, but do not remove both grille lock screws. See below.

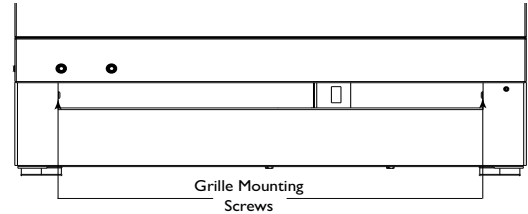

3. Gently pull grille away from unit until it stops.
4. Push grille rails towards the center of the unit to lift rails off lock screws.
5. Pull grille free from unit.

**Installing the grille.**

1. Align slots in grille rail with screw heads in base of unit.
2. Push grille rails towards the center of the unit and set rails over screw head.
3. Slide grille into position. Using included 7/64" Allen wrench, tighten grille lock screws.

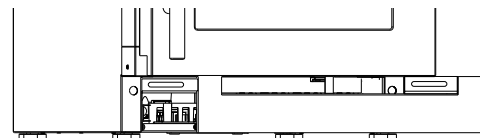

**Adjusting Grille**

The grille has an automatic vertical plane adjustment and can also be adjusted on its horizontal plane as well. To adjust your grille to match your surrounding cabinetry follow the instructions below.

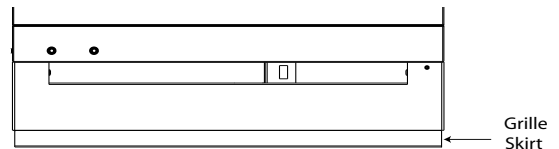

1. Loosen, but do not remove, the lock screws on the inside of the grille rails. Lock screws are located on the inside of each grille rail.
2. Pull grille out to desired position and secure lock screws.
3. The grille skirt may be manually adjusted to the height of your floor. Simply raise or lower the skirt as needed.

**5 3000 Series Doors**

**Door Alignment and Adjustment**

Align and adjust the door if it is not level, or is not sealing properly. If the door is not sealed the unit may not cool properly, or excessive frost or condensation may form in the interior.

**NOTICE**

Properly aligned, the door's gasket should be firmly in contact with the cabinet all the way around the door (no gaps). Carefully examine the door's gasket to assure that it is firmly in contact with the cabinet. Also make sure the door gasket is not pinched on the hinge side of the door.

**CAUTION**

- Do not attempt to use the door to raise or pivot your unit. This would put excessive stress on the hinge system.
- Pay special attention to the Cable Arm. Make sure not to over extend or damage it during door alignment.

**Stainless Models (Removing Wrap)**

1. Open door completely.
2. Using a Phillips screwdriver, remove the two wrap screws from the bottom of the stainless steel door wrap.

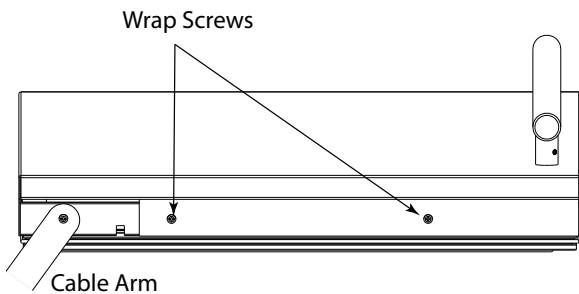

3. Gently pull bottom of wrap away from door.
4. The wrap hinges on top of the door. Carefully pull wrap away and then up. **See below.**

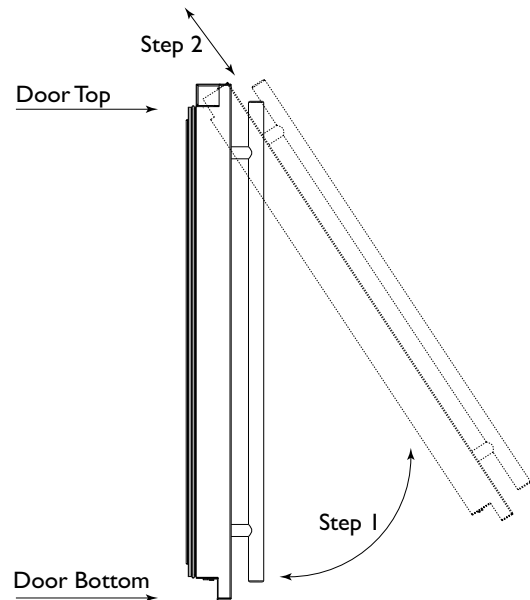

5. Remove cable from display by pressing in the release tab on the cable connector.

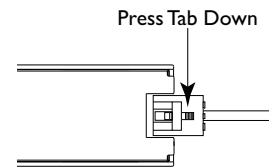

**Alignment and Adjustment**

1. Using a T-25 Torx Bit, loosen each pair of torx head screws on both the upper and lower hinge plate.
2. Square and align door as necessary.
3. Tighten Torx head screws on hinge.
4. Re-connect display and re-install stainless steel wrap.

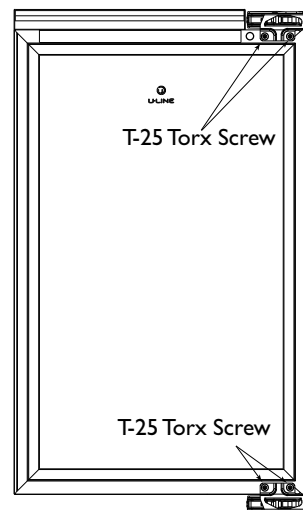

## 6 Cleaning

### Exterior Cleaning

- Stainless door panels, and handles can discolor when exposed to chlorine gas, pool chemicals, saltwater or cleaners with bleach.
- Keep your stainless unit looking new by cleaning with a good quality all-in-one stainless steel cleaner polish monthly. For best results use Claire® Stainless Steel Polish and Cleaner, which can be purchased from U-Line Corporation (Part Number 173348). Comparable products are acceptable. Frequent cleaning will remove surface contamination that could lead to rust. Some installations may require cleaning weekly.
- **Do not clean with steel wool pads.**
- **Do not use stainless steel cleaners or polishes on any glass surfaces.**
- Clean any glass surfaces with a non-chlorine glass cleaner.
- **Do not use cleaners not specifically intended for stainless steel on stainless surfaces (this includes glass, tile and counter cleaners).**
- If any surface discoloring or rusting appears, clean it quickly with Bon-Ami® or Barkeepers Friend Cleanser® and a nonabrasive cloth. Always clean with the grain. Always finish with Claire Stainless Steel Polish and Cleaner or comparable product to prevent further problems.
- **Using abrasive pads such as Scotchbrite™ will cause the graining in the stainless to become blurred.**
- **Rust not cleaned up promptly can penetrate the surface of the stainless steel and complete removal of the rust may not be possible.**

### Interior Cleaning

- **Disconnect power to the unit.**
- Clean the interior and all removed components using a mild nonabrasive detergent and warm water solution applied with a soft sponge or non-abrasive cloth.
- Rinse the interior using a soft sponge and clean water.
- Do not use any solvent-based or abrasive cleaners. These types of cleaners may transfer taste to the interior products and damage or discolor the lining.

### Clear Ice Maker Cleaning Cycle

The 3000 series ice maker is equipped with an automatic clean alert function. Cleaning cycles should be run as notified. Otherwise, to maintain operational efficiency, the unit should be cleaned every three months. Depending on water conditions, more frequent cleaning may be necessary. If the ice maker requires more frequent cleaning, consult a plumber to test the water quality and recommend appropriate treatment.

#### NOTICE

**Wear rubber gloves and safety goggles and/or face shield when handling Ice Machine Cleaner.**

#### NOTICE

**Discard all ice produced in the first harvest.**

#### NOTICE

**Should power to the unit be interrupted during the self-clean cycle, the complete cleaning cycle will repeat after power is restored. S**

#### CAUTION

**Use only U-Line Ice Machine Cleaner (Part No. 37050, available from your dealer or direct from your local parts distributor. To locate a parts distributor near you, visit [www.U-LineService.com](http://www.U-LineService.com). It is a violation of federal law to use this solution in a manner inconsistent with its labeling. Use of any other cleaner can ruin the finish of the evaporator and will void the warranty. Read and understand all labels printed on the package before use.**

U-Line Ice Machine Cleaner is used to remove lime scale and other mineral deposits. Refer to the following steps to initiate the self-cleaning cycle.

#### CAUTION

**Never use anything to force ice from the evaporator. Damage may result.**

1. Turn the ice maker off and allow any ice to melt off of the evaporator.
2. Remove all ice from the storage bin.
3. Remove evaporator cover.
4. Remove the standpipe by lifting it up while using a slight back and forth motion to loosen it from the drain hole. The water in the reservoir will flow down the drain.

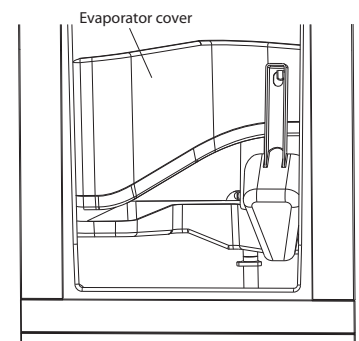

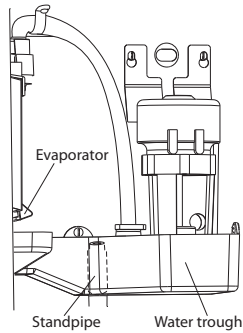

5. Re-install the standpipe into the water trough.

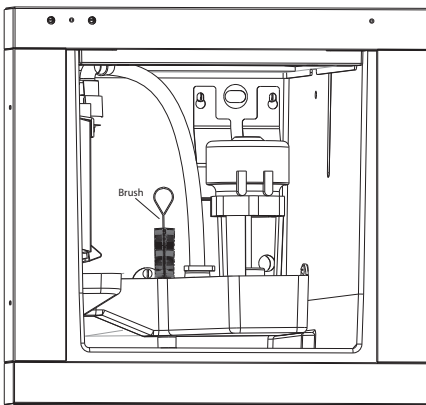

6. Clean the Interior Bin as follows:

- Dilute one packet of CLR cleaner into two quarts of water.
- Using a sponge or cloth, clean interior of ice bin, tubing and door. This cleaner will remove all mineral deposits and other contaminants from the surfaces.
- Using a bottle brush, clean out the trough drain tube and pump tubing where needed.



7. Turn unit on by touching **POWER** .
8. Place unit in cleaning mode by activation through the Customer Menu. See **PRODUCT OPERATION** for more detail.
9. When water begins flowing over the evaporator (approximately 3 minutes), pour 1 packet of CLR cleaner into the water trough. The cleaning process will last approximately 45 minutes.
10. Dilute 1 tablespoon bleach in 1 gallon of warm water. Apply this solution to the entire inside of the storage area. Then rinse thoroughly with water.

The unit will resume operation approximately 15 minutes after the automated cleaning process is completed. The water fill valve will energize, fill the water reservoir, and shut-off after three minutes. The compressor begins to operate and water flows over the evaporator assembly (ice mold). Initially, the water flow may not be uniform, causing uneven sized cubes or water to spill into the ice storage bin. This is a normal situation that will correct itself within the first 24 hours of operation.

## Condenser Cleaning

### Interval - As Needed

To maintain operational efficiency, keep the front grille free of dust and lint, and clean the condenser when necessary. Depending on environmental conditions, more or less frequent cleaning may be necessary.

### **WARNING**

Disconnect electric power to the unit before cleaning the condenser.

### **NOTICE**

**DO NOT** use any type of cleaner on the condenser unit. Condenser may be cleaned using a vacuum, soft brush or compressed air.

1. Remove the grille. (See MAINTENANCE)
2. Clean the condenser coil using a soft brush or vacuum cleaner.

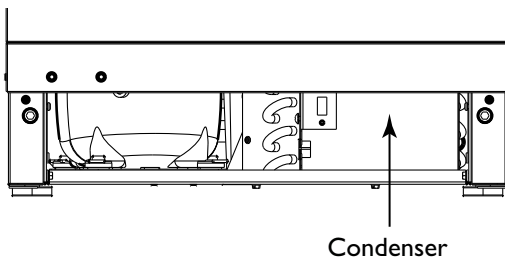

3. Install the grille. (See MAINTENANCE)

## Storage, Vacation and Moving

If not using the unit for an extended period, or otherwise stored, follow these steps completely:

### **WARNING**

**Electrical Shock Hazard. Disconnect power before servicing. Before operating, replace all panels. Failure to do so may result in electrical shock or death.**

### **NOTICE**

If the ambient temperature is expected to drop below 50°F (10°C), turn off and unplug unit.

1. Remove all ice from the unit. If ice is on the evaporator; allow ice to thaw naturally.

### **CAUTION**

**DO NOT** use an ice pick or other sharp instrument to help speed up defrosting. These instruments can puncture the inner lining or damage the cooling unit. **DO NOT** use any type of heater to defrost. Using a heater to speed up defrosting can cause personal injury and damage to the inner lining.

2. Disconnect the power cord from its outlet, and leave it disconnected until the unit is returned to service.
3. Clean and dry the interior of the cabinet.
4. During periods of nonuse, the cabinet must remain open to prevent formation of mold and mildew. Open door a minimum of 2 in. (5 cm) to provide the necessary ventilation.

## Product Disposal

### **DANGER**

**RISK OF CHILD ENTRAPMENT. Before you throw away your old refrigerator or freezer, take off the doors and leave shelves in place so children may not easily climb inside.**

If the unit is being removed from service for disposal, check and obey all Federal, State and Local regulations regarding the disposal and recycling of refrigeration appliances, and follow these steps completely:

1. Remove all consumable contents from the unit.
2. Disconnect power to the unit's power receptacle. Unplug the power cord from its outlet.
3. Remove the cabinet door.

## 7 Service

### Before Calling for Service

If you think your U-Line product is malfunctioning, read the OPERATION section of this guide to understand clearly the function of the control.

If the problem persists, read the NORMAL OPERATING SOUNDS and TROUBLESHOOTING GUIDE section of this guide to help you quickly identify common problems, and possible causes and remedies. Most often, this will resolve the problem without the need to call for service.

### If Service is Required

If you do not understand a troubleshooting remedy, or your product needs service, contact U-Line Corporation directly. Contact information appears on the rear cover of this guide.

When you call, you will need your product Model and Serial Numbers. This information can be recorded inside the front cover of this guide. It also appears on the Model and Serial number plate located on the interior of your product or can be accessed through “Help” in the Customer Menu.

### Replacement Parts

When you need replacement parts, always request genuine U-Line replacements. U-Line designs and engineers products using components that work efficiently, and provide superior service life and performance. The use of aftermarket parts or components may affect the safety, operation, performance or durability of your product, and may also void its warranty.

### Normal Operating Sounds

All models incorporate rigid foam insulated cabinets to provide high thermal efficiency and maximum sound reduction for its internal working components. Despite this technology, your model may make sounds that are unfamiliar.

Normal operating sounds may be more noticeable because of the unit’s environment. Hard surfaces such as cabinets, wood, vinyl or tiled floors and paneled walls have a tendency to reflect normal appliance operating noises.

Listed below are common refrigeration components with brief description of the normal operating sounds they make. NOTE: Your product may not contain all the components listed.

- **Compressor:** The compressor makes a hum or pulsing sound that may be heard when it operates.
- **Evaporator:** Refrigerant flowing through an evaporator may sound like boiling liquid.
- **Condenser Fan:** Air moving through a condenser may be heard.
- **Automatic Defrost Drain Pan:** Water may be heard dripping or running into the drain pan when the unit is in the defrost cycle.
- **Solenoid Valves:** An occasional clicking sound may be heard as solenoid valves are operated.

## Troubleshooting Guide



**ELECTROCUTION HAZARD.** Never attempt to repair or perform maintenance on the unit until disconnecting the main electrical power.

**Troubleshooting -** What to check when problems occur:

Problem	Possible Cause and Remedy
Digital Display and Light Do Not Work.	Ensure power is connected to the unit. If the unit is cooling, it may be in Sabbath mode. (See OPERATION)
Interior Light Does Not Illuminate.	If the unit is cooling it may be in Sabbath mode, or manually set to off. (See OPERATION)
Light Remains on When Door is Closed.	Lighting may be set to On, reset to with door. (See OPERATION)
Unit Develops Condensation on External surfaces	The unit is exposed to excessive humidity, moisture will dissipate as humidity levels decrease.
Digital Display Functions, But Unit Does Not Produce Ice.	Ensure the unit is not in ‘Showroom Mode’. Press and hold the Power icon for five seconds to exit Showroom mode. Press the power button again to resume normal operation.
Digital Display Shows an Error.	“Door” indicates the door may be opened too long, ensure the door is closing properly. For other error codes contact U-Line Customer Service.
Ice Is Too Thick/Thin	Ice Adjust not set to user’s preference. Adjust ice thickness via Customer Menu.
Poor Ice Quality	Unit may not be level. Check unit for levelness. (See MAINTENANCE) Ice maker may be dirty. Clean ice maker. (See CLEANING)
No Ice Production	Ensure water is being supplied to the unit. Verify the ice making unit is turned on. (See OPERATION)
Not Enough Ice	Ensure the condenser coil is clean and free of any dirt or lint buildup.
Water in Bin	Ensure the unit is plugged in. Check if the drain is restricted. Ensure drain is free of foreign debris and hose is not kinked or twisted.
Hear Running Water	During ice creation, the water running over the evaporator may be heard.
Hear Ice Falling	After each harvest, ice will fall into the bin.



## PRODUCT INFORMATION

Complete Installation Guides, Use and Care Guides, Specifications & Features and Benefits, CAD Drawings, Overlay Panel/Frame and Toe-Kick Specifications and Instructions, Compliance Documentation and Applicable Energy Guides are available for reference and download at [u-line.com](http://u-line.com).

## SERVICE INFORMATION

Please consult your Use and Care Guide for troubleshooting information. Answers to Customer Frequently Asked Questions are available at [u-line.com](http://u-line.com) under Customer Service. You may contact U-Line directly:

### GENERAL INQUIRIES:

U-Line Corporation  
P.O. Box 245040  
Milwaukee, Wisconsin 53224-9540 U.S.A.  
Phone 1-414-354-0300  
FAX 1-414-354-7905  
Email: [sales@u-line.com](mailto:sales@u-line.com)  
[u-line.com](http://u-line.com)

### SERVICE ASSISTANCE:

Phone 1-800-779-2547  
FAX 1-414-354-5696  
Email: [onlineservice@u-line.com](mailto:onlineservice@u-line.com)  
[u-lineservice.com](http://u-lineservice.com)

### PARTS ASSISTANCE:

E-mail: [onlineparts@u-line.com](mailto:onlineparts@u-line.com)

---

## BUILDING ON THREE GENERATIONS OF INNOVATION

For nearly five decades and three generations, U-Line continues to be the leader in innovation, quality and value in the premium built-in undercounter ice making, refrigeration and wine preservation market. U-Line has captivated those with an appreciation for the finer things with exceptional functionality, style, inspired innovation and attention to even the smallest details. We are known and respected for our unwavering dedication to product design, quality and selection.

In 1962, Henry Uihlein founded U-Line Corporation as an outgrowth of Ben-Hur Freezer Company and was the first to develop and patent an automatic stand-alone undercounter residential ice maker. His foresight and determination to develop new ideas and to succeed when there were no clear guidelines or solutions are evident today. The newest Uihlein generation continues to build upon the family's innovative legacy at the Milwaukee, Wisconsin based business by providing continuity and vision from which new designs and technology continue to be born.

Today the complete U-Line product collection includes Ice Makers, Wine Captain® Models, Combo® Models, a Refrigerator / Freezer, Refrigerators, Drawers and Beverage Centers. The U-Line brand offers products in the 1000 Series, 2000 Series and the Modular 3000 Series. The 1000 Series offers a more targeted priced product with appropriate features, while the 2000 Series offers upscale features, advanced technology and specialized product families. U-Line's approach to its breadth of products, multiple price points and features allows a choice and product that will fit any lifestyle.

## DESIGNED, ENGINEERED AND ASSEMBLED IN WISCONSIN, USA