



Freezer

FFFC05M4N W

Manual Defrost
5 Cu. Ft. Chest



Product Dimensions

Height (Including Lid)	32-5/16"
Width	28-5/8"
Depth	22"

More Easy-To-Use Features

Defrost Water Drain

Use the drain to conveniently remove water during defrosting.

Lid Handle

Available in:



White
(W)

Signature Features

Store-More™ Removable Basket

Convenient lift-out storage for easy access to most small frozen items or items that are most frequently used.

Power-On Indicator Light

Know at a glance that your freezer is working.

Adjustable Temperature Control

Select the correct temperature for your needs.

Color-Coordinated Handle

Features	
Defrost	Manual
Adjustable Temperature Control	Yes
Interior Lighting	
Store-More™ Removable Baskets	1
Food Organization System	
Defrost Water Drain	Yes
Lid Handle	Yes
Lock with Pop-Out Key	
Power-On Light	Yes
Certifications	
ENERGY STAR®	
CSA Rating	Household
Specifications	
Total Capacity (Cu. Ft.)	5.1
Annual Energy (kWH)	242
Annual Energy Cost (.1065/kWH)	\$26
Power Supply Connection Location	Right Bottom Rear
Voltage Rating	120V/60Hz/5A
Connected Load (kW rating) @ 120 Volts¹	.6
Amps @ 120 Volts	5
Minimum Circuit Required (Amps)	15
Shipping Weight (Approx.)	85

¹An electrical supply with grounded three-prong receptacle is required. The power supply circuit must be installed in accordance with current edition of National Electrical Code (NFPA 70) and local codes & ordinances.

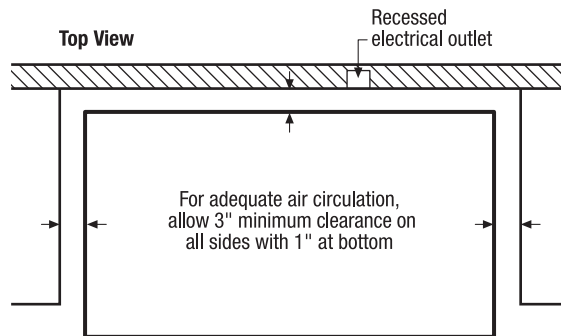
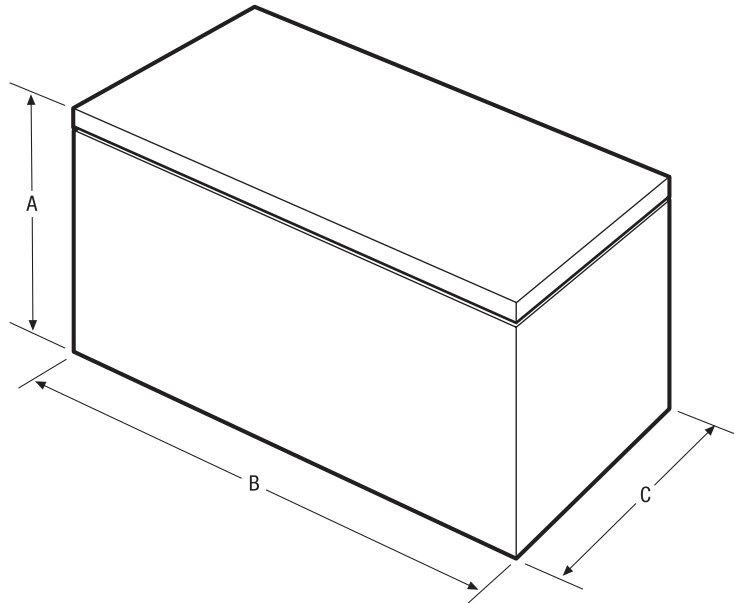

NOTE: For planning purposes only. Always consult local and national electric codes. Refer to Product Installation Guide for detailed installation instructions on the web at frigidaire.com.



Product Dimensions	
A - Height (Including Lid)	32-5/16"
B - Width	28-5/8"
C - Depth	22"
Height with Lid Open 90°	52"

Accessories information available on the web at frigidaire.com

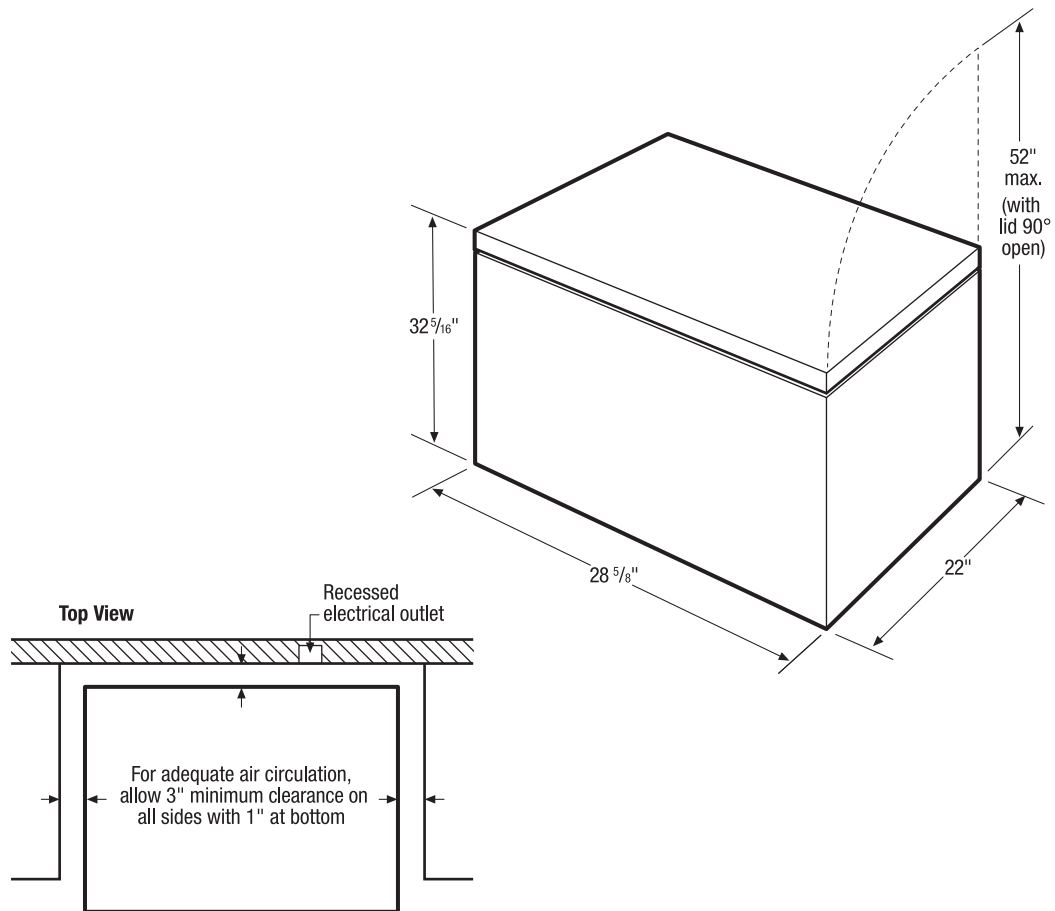

Chest Freezer Specifications

- Product Shipping Weight (approx.) - 85 Lbs.
- An electrical supply with grounded three-prong receptacle is required. The power supply circuit must be installed in accordance with current edition of *National Electrical Code (NFPA 70)* and local codes & ordinances.
- Voltage Rating - 120V / 60 Hz / 5 Amps
- Connected Load (kW Rating) @ 120 Volts = 0.6 kW
- Amps @ 120 Volts = 5 Amps
- Always consult local and national electric codes.
- For adequate air circulation, allow 3" minimum clearance on all sides with 1" at bottom.
- Locate where surrounding air temperature will not exceed 110° F, to ensure optimum performance. (Temperatures 32° F and below will NOT affect operation.)
- All bottom corners of unit MUST rest firmly on solid level surface of hard material, same height as flooring. Surface must be strong and stable enough to support unit when fully loaded.
- Equipped with adjustable leveling legs to ensure unit is level, which is required in order to function properly.

Note: For planning purposes only. Refer to Product Installation Guide on the web at frigidaire.com for detailed instructions.