



USE AND CARE GUIDE

- BUILT-IN UNDER-COUNTER REFRIGERATORS
- BUILT-IN UNDER-COUNTER FREEZERS
- BUILT-IN WINE CELLARS
- OUTDOOR REFRIGERATORS AND FREEZERS
- INDOOR DRAWER REFRIGERATORS AND FREEZERS
- OUTDOOR DRAWER REFRIGERATORS AND FREEZERS
- AUTO-DEFROST BI605FF SERIES

MODELS

- ALB651 / ALB653B SERIES
- ALB751 / ALB753B SERIES
- BI540 / BI541 SERIES
- BI605FF SERIES
- CT66BI / CT67BI SERIES
- FF6BI & FF7BI SERIES
- FS62BI SERIES
- SCFF55 SERIES
- SCR600BI SERIES
- SCR600LOS SERIES
- SP6 DRAWER SERIES
- SP6DS2DOS SERIES
- SP6DSSTBOS SERIES
- SPF5DSSTB
- SPR601OS SERIES
- SPR7OS SERIES
- SWC6GBI SERIES
- OUTDOOR REFRIGERATORS

If you need service or call with a question, please have the following information ready.
We advise you to keep this Owner's Manual in your possession.

Model: _____ Serial number: _____

Options added: _____

Date of Purchase _____ Where Purchased _____

APPLIANCE SAFETY

Your safety and the safety of others are very important to us.

We have provided many important safety messages in this manual and on your appliance. Always read and obey all safety messages. You can be killed or seriously injured if you do not follow these instructions.

Safety messages will tell you what the potential hazard is, how to reduce the chance of injury, and what can happen if the instructions are not followed.

IMPORTANT SAFETY INSTRUCTIONS!

WARNING: To reduce the risk of fire, electric shock or injury when using your refrigerator/freezer, follow these basic precautions:

- Plug into a grounded 3-prong outlet.
- Do not remove ground prong, nor use a 3/2 adapter.
- Do not use an extension cord.
- Use care not to plug into outlets controlled by wall switches.
- Disconnect power before servicing.
- After servicing, replace all parts and panels before operating.
- Use nonflammable cleaners.
- Keep flammable materials and vapors, such as gasoline, away from appliances.
- Use two or more people to move and install appliance.
- **Drawer refrigerators are provided with anti-tip brackets. Always install prior to use.**

Proper Disposal of Your Old Appliance

Old appliances can represent a suffocation hazard to children.

- **Remove doors from your old appliance.**
- **Leave shelves in place.**
- **If an old appliance contains refrigerants, it must be recycled by a licensed service or disposal company.**

INSTALLATION INSTRUCTIONS

UNPACKING

Excessive Weight Hazard!
Use two or more people to move and install your appliance.
Failure to do so can result in back or other injury.

ALLOW APPLIANCE TO SIT UPRIGHT FOR 24 HOURS BEFORE TURNING ON, TO ALLOW THE COMPRESSOR LUBRICANT TO DRAIN.

1. Remove packaging materials.
2. Remove tape and glue residue from surfaces before turning on the appliance. Rub a small amount of liquid dish soap over the adhesive with your fingers. Rinse with warm water and dry.
3. Do not use sharp instruments, rubbing alcohol, flammable fluids, or abrasive cleaners to remove tape or glue. These products can damage the surface of your appliance.
4. **When Moving Your Appliance:**
Your appliance is heavy. When moving the appliance for cleaning or service, be sure to protect the floor. Always pull the appliance straight out when moving it. Do not wiggle or “walk” the appliance when trying to move it, because floor damage can occur.
5. **Clean Before Using**
After you remove all of the packaging materials, clean the inside of your appliance before using it. See the cleaning instructions in *Appliance Care*.
6. All upright models have level legs in the front and many also have them in the rear. Level as necessary for best operation.
7. If your appliance has casters, after moving into place, lock the brakes on those casters supplied with brakes. Always unlock before moving the appliance for cleaning.

Keep flammable materials and vapors, such as gasoline, away from appliances. Failure to do so can result in explosion or fire.

LOCATION REQUIREMENTS

IMPORTANT: Do not install the appliance near an oven, radiator, or other heat source, nor in a location where the temperature will fall below 45°F (7°C). Do not place in direct sunlight.

Check the strength of the floor before installing your appliance. It should hold the weight of a fully-loaded appliance. Allow at least 1” (2.5 cm) of airspace at the top and on both sides of the appliance and 1” (2.5 cm) between the back of the appliance and the wall. If the appliance is going to be placed against a wall, if possible, leave extra space on the hinge side so the door can open wider than its width (to make it easier to remove shelves or storage bins).

NOTE: This appliance may be installed side by side with another appliance. Allow for a 3” (7.5 cm) clearance at the top and sides, and a 1/4” (0.64 cm) clearance between the appliances.

IF YOUR MODEL HAS THE LETTERS “BI” IN THE MODEL NUMBER OR SUFFIX, OR BEGINS WITH “ALB”, IT IS DESIGNED FOR BUILT-IN USE AND DOES NOT REQUIRE CLEARANCE EXCEPT IN THE BACK. BE SURE THAT YOU DO NOT BLOCK THE AIRFLOW UNDER THE APPLIANCE .

INSTALLATION INSTRUCTIONS

CHOOSING THE RIGHT PLACE

Place the appliance in a dry and regularly ventilated place. It is recommended that this appliance always be operated in an ambient temperature of at least 60°F and under 85°F. The appliance may be exposed to lower or higher temperatures but only for a short period of time and the temperature should never be lower than 45°F. Never place the appliance near heat-emitting devices (e.g., oven, radiator, water heater) and do not expose it to direct sunlight.

RECOMMENDED GROUNDING METHOD

A 115 Volt (AC only) 60 Hz grounded electrical supply equipped with a 15- or 20- amp fuse or circuit breaker is required. It is recommended that a separate circuit serving only your appliance be provided. Use outlets that cannot be turned off by a switch or pull chain. Connect this appliance to a 3-prong power supply outlet that has a ground terminal. If you only have a 2-prong outlet, have it replaced by a qualified technician with an outlet that meets the local codes. **DO NOT USE AN EXTENSION CORD.** Required nominal voltage and frequency are indicated on the rating plate. The connection to the power supply and grounding has to be made according to current standards and regulations. The appliance can resist temporary voltage fluctuations from -15 to +10%.

FOR OUTDOOR MODELS ONLY

Electrical Shock Hazard! Plug into a grounded 3-prong outlet. Do not remove ground prong. Do not use an adapter.

Do not use an extension cord. Failure to follow these instructions can result in fire or electrical shock.

Many outdoor outlets are controlled by wall switches. Turning power off and then on again may cause the GFCI switch to trip.

A GFCI (ground fault circuit interrupter) is built into every line cord. Do not defeat or bypass this important safety feature. The line cord supplied with this appliance is specially designed for outdoor use. Use only a factory-supplied replacement cord with a GFCI in the event the cord becomes damaged.

You may purchase these cords from either our sales or service department at **718-893-3900 (sales)** or **718-328-8700 (service)**.

They can also be ordered online from www.summitapplianceparts.com

ENERGY SAVING TIPS

- The more airflow you can provide around an appliance, the less energy it will use.
- If your appliance needs defrosting, keep ice build-up to less than 1/2 inch.
- Keep doors or drawers open a minimum of time, and shut securely.

LEVELING YOUR APPLIANCE

1. Locate the two front leveling legs, which may be taped among the packing materials. In most models these legs are already mounted into the underside of the appliance.
2. Screw these legs into the front holes on the bottom of the appliance. The back of the appliance rests on two fixed supports. (Built-in models also have rear level legs that can provide more precise leveling).
3. Adjust the front legs just enough to lift the cabinet up off the floor.
4. Place a leveling tool on top of the appliance: first side to side, then front to back. Turn leg counter-clockwise to raise a corner. Turn leg clockwise to lower a corner.
5. Repeat Step 4 until appliance is level.
6. After appliance is fully loaded, recheck with level as in Step 4.
7. If your appliance is equipped with casters, the two front casters have brakes to prevent rolling. Keep brakes locked, and unlock for moving only.

APPLIANCE USE

In order to ensure proper temperature, you need to permit proper airflow in the appliance. Do not block any air vents. If the vents are blocked, airflow will be prevented, and temperature and moisture problems may occur. Always position contents to allow some airflow between shelves or baskets.

Allow the appliance to cool at least 6 to 8 hours before adding contents. Allow 24 hours for temperature to stabilize.

NOTE: When the appliance is first started, the compressor will run constantly until the appliance is cold. It may take 6 to 8 hours (or longer), depending on room temperature and the number of times the appliance door is opened. After the appliance is cooled, the compressor will turn on and off as needed to keep the appliance at the proper temperature.

The outside of your appliance may feel warm. This is normal. The appliance's design and main function is to remove heat from packages and air space inside the appliance. The heat is transferred to the room air, making the outside of the appliance feel warm. *In some models the condenser that gets warm is inside the side walls, making these walls warm to the touch.*

REVERSING THE DOOR SWING (Selected models)

If you find the direction of opening the door on your appliance inconvenient, on some models you can change it. Holes on the opposite side have already been prepared in the factory. On models with our wrapped stainless steel door and 12-inch pro handle (suffix SSTB, SSVH or CSS, or with optional handles "TB" or "SH"), you must order these with either a right hand or left hand door swing in advance. These doors cannot be reversed. Models with suffix SSHH, BIFR, BIIF and CSSHH can be reversed.

TO REVERSE YOUR DOOR

- Take off the upper hinge cover from the door and remove the screws that hold the top hinge.
- Lift the hinge straight up to free the hinge pin from the socket in the top of the door.
- Lift the door up and away to free its bottom socket from the hinge pin.
- Remove the screws to the bottom hinge.
- Remove the decorative caps from the opposite side and plug the holes from the original side with the decorative caps.
- Move the bottom hinge to the opposite side and tighten the screws. Use any lock washers or nuts if they were included in the original installation.
- Replace door onto the hinge pin on the bottom hinge. Place top hinge pin into door. Insert screws into top hinge and tighten.

If you notice the door is not hanging straight, loosen the top hinges, adjust the door until it is level and tighten the screws.

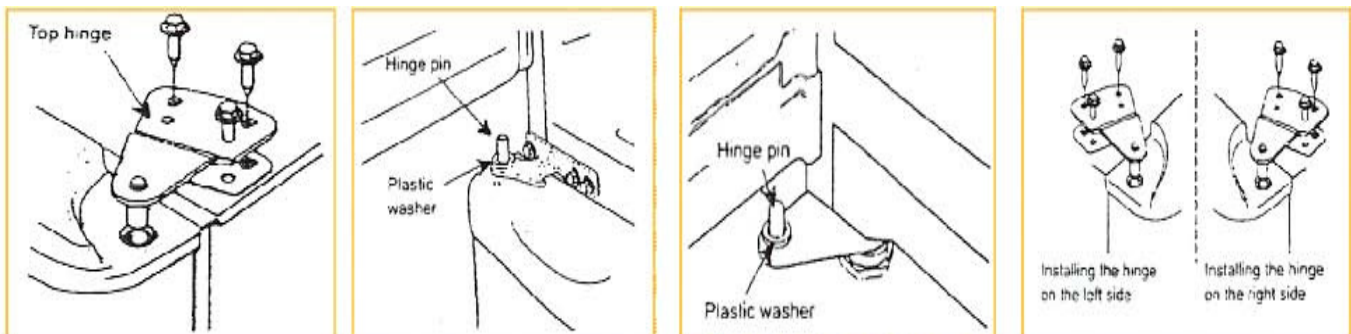

APPLIANCE OPERATION

Base Grill (some models only)

To Remove and Replace the Base Grill:

1. Open the appliance door and remove the base grill by pulling down and out from the top.
2. Replace the base grill by putting the clips in the openings in the appliance panel. Push in until the base grill snaps into place.

An optional stainless steel grill is available for some models (model numbers beginning with FF6, FF7, CT66, CT67, SCR600, FS62, SCFF55, BI540, BI541, SWC6G and outdoor units and drawer units). You can order at

www.summitapplianceparts.com

Changing the light bulb (some models only)

NOTE: Not all appliance bulbs will fit your appliance. Be sure to replace the bulb with one of the same size, shape, base size and wattage. You can purchase bulbs at www.summitapplianceparts.com

1. Unplug appliance or disconnect power.
2. Remove the light shield. Most models do not require tools.
3. Replace the light bulb with an appliance bulb of the same wattage.
4. Replace the light shield.
5. Plug in appliance or reconnect power.

Loss of Power

After the power is restored, unplug the appliance for 30 minutes to allow the refrigeration system to equalize. During this time, keep the door closed whenever possible.

REMEMBER: A full appliance stays cold longer than a partially filled one.

Moving Care

1. Remove all containers.
2. Unplug the appliance.
3. Clean it thoroughly.
4. Tape the appliance shut and tape the electrical cord to the cabinet.

When you get to your new location, refer to the *Installation Instructions* and *Appliance Use* sections for information on installation and setting the controls.

Removal / Replacing of the Drawers on the SP6DS, SP6DSSTB or SP6DS2D models

To remove the drawers from the refrigerator, these directions need to be followed:

1. Pull the drawer out towards you completely.
2. On both sides of the drawer there are stainless steel slides.
3. On each slide there is a black lever.
4. The left lever should be pulled up.
5. The right lever should be pulled down. Both levers should be pulled at the same time while continuing to pull the drawer.

To re-install the drawers on the appliance:

Simply line up the hinges on the drawer and the hinges on the appliance and gently push the drawer in. Once lined up, close the drawer completely, then open again to make sure the drawer is on track.

APPLIANCE CARE

Cleaning Your Frost-Free Refrigerator

Use nonflammable cleaners.

Frost-free means that you do not have to defrost your appliance. Frost is removed by air moving and collecting any moisture and depositing it on the cooling coil. The cooling coil periodically warms up enough to melt the frost, and the water then flows down to the drain pan (located behind the base grill) where it is evaporated.

Complete cleaning should be done at least once a year.

1. Unplug appliance or disconnect power.
2. Remove all substances.
3. Wash the inside walls with a solution of mild detergent in warm water or 2 tbs (26 g) baking soda to 1 qt (0.95 L) warm water.
 - Do not use abrasive or harsh cleaners such as window sprays, scouring cleansers, flammable fluids, cleaning waxes, concentrated detergents, bleaches or cleansers containing petroleum products on plastic parts, interior and door liners or gaskets. Do not use paper towels, scouring pads, or other harsh cleaning tools. These can scratch or damage materials.
4. Rinse well and wipe dry with a clean soft cloth.
5. Use the appropriate cleaning method for your exterior finish.

Painted metal: Wash exteriors with a clean sponge or soft cloth and a mild detergent in warm water. Do not use abrasive or harsh cleaners, or cleaners designed for stainless steel. Dry thoroughly with a soft cloth. For additional protection against damage to painted metal exteriors, apply appliance wax (or auto paste wax) with a clean, soft cloth. Do not wax plastic parts.

6. Plug in appliance or reconnect power.
7. Replace all containers.

Stainless steel: Clean stainless steel with special stainless steel cleaners only. Do not use bleach or any abrasive cleaners.

Cleaning your cycle defrost or manual defrost refrigerator

Cycle defrost models utilize a system where ice builds up on the rear wall and melts when the compressor is off. Manual defrost models continually build ice on inner walls.

NEVER USE A METAL OBJECT TO REMOVE ICE FROM THE REAR WALL. IF NEEDED, USE A PLASTIC ICE-SCRAPER OR A HAIR DRYER.

Clean surfaces, using the same instructions as for frost-free models.

For CSS Models (completely stainless steel) or models with stainless steel doors and handles, please use only cleaners especially made for stainless steel.

TEMPERATURE SELECTION

**YOUR APPLIANCE MAY HAVE A MECHANICAL (DIAL) OR DIGITAL THERMOSTAT.
INSTRUCTIONS FOR BOTH FOLLOW:**

MECHANICAL THERMOSTAT INSTRUCTIONS

The refrigerator is controlled with a thermostat knob located inside the unit, toward the upper right-hand corner. Turn the knob clockwise from the **STOP (0)** position toward the higher numbers for colder temperatures.

Temperature Controls

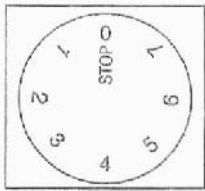

- Higher settings on the knob (higher numbers) mean lower temperatures (colder) in all compartments of the appliance. At the coldest settings, temperatures in some spots of the interior of the appliance may even drop below 32°F. Use higher thermostat settings only when required or recommended. When the ambient temperature is normal, we recommend the medium setting.
- Changes of the ambient temperature affect temperature in the interior of the appliance so keep this in mind when choosing the setting of the thermostat knob.
- In the **STOP (0)** position the appliance does not operate (the cooling system is switched off), yet power supply is not interrupted (the light goes on when you open the refrigerator door).
- The temperature in the refrigerator and in the freezer compartment also depend on how often you open the door.
- In all small refrigerators and freezers without interior fans, temperatures are coldest near the bottom, and occasionally near the rear. Place contents accordingly. It is best not to operate these units mostly empty. If temperatures are erratic, try putting some water bottles or freezer packs inside to create a load for the compressor.

DIGITAL THERMOSTAT INSTRUCTIONS

If you find that it is necessary to change the temperature setting for your digital thermostat-controlled appliance, please refer to the following instructions. The front panel of the thermostat is illustrated here:



To see the **SETPOINT**:

Push and immediately release the **SET** key. The display will show the **SET** point value. Wait 5 seconds and the probe value will display again.

To change the **SETPOINT**:

Push and hold the **SET** key for more than 3 seconds to change the *setpoint* value. The value of the *setpoint* will be displayed and the "snowflake" LED will start blinking. To change the SET value, push the up or down arrows to the desired setting. The new setting will be memorized after 15 seconds, provided no other keys are pushed.

Note: The minimum and maximum range of your thermostat is preset and locked by us, so it cannot easily be accidentally moved between freezer and refrigerator temperatures. To reset this range lock, either call us or find information on our website under *Troubleshooting*.

KEYPAD LOCK (optional on most models)



Factory set default password: The factory set default password is 0123. If the default password is lost, press the  key (located inside the battery box) for 30 seconds, then wait for the warning sound which signifies the factory set default password has been restored.

To set the password: While door is open, press the  key (located inside the battery box) until it jingles, enter the 0123 password then the # key within 10 seconds to confirm. Enter the password (1-16 digits), then press # again to confirm. A total of 10 passwords can be set.

Note: Each password starts from the number 0 to 9 in order. The first password starting with 0 is the default password. For example, use 1xxx, then 2xxx etc. for 10 users.

Changing password: While the door is open, press the  key (located inside the battery box) until it jingles, enter the old password and press # within 10 seconds to confirm. Enter new password then press # to confirm. Note that the first digit cannot be changed.

To open the door: While the door is closed, press the  key, enter the password then press  again to confirm.

To lock door manually: Press #.

Function setting of automatic lock: To set the auto-lock to lock on a preset time interval, press the  key (inside the battery box), enter a number (the time interval in seconds from 10-99) then press # to confirm. The auto-lock time can be set between 10-99 seconds after opening the door. If the time is set less than 10 seconds, the door will not lock automatically, only manually.

Deleting the door-opening passwords: Press the  key, enter default password followed by 0000, then press # and all the door-opening passwords will be deleted except for the default password.

Note: To access the battery box you need to remove only the two small screws on the top and bottom of that cover. Do not remove the 4 screws holding the keypad and cover to the appliance door.

IF YOUR MODEL HAS A FRONT LOCK (SELECTED MODELS)

Your lock has a feature called automatic key eject. To lock or unlock the appliance, you must push and hold the key in the lock while turning. The lock is spring-loaded, so the key cannot be left in the lock.

If the key is lost, contact your dealer or SUMMIT APPLIANCE to purchase a replacement. Always give the model and serial number of your appliance when requesting a replacement key. Keys for most models can be ordered online at

www.summitapplianceparts.com

NEVER KEEP KEYS WITHIN THE REACH OF CHILDREN

ALARM INSTRUCTIONS (alarms are optional on most models)

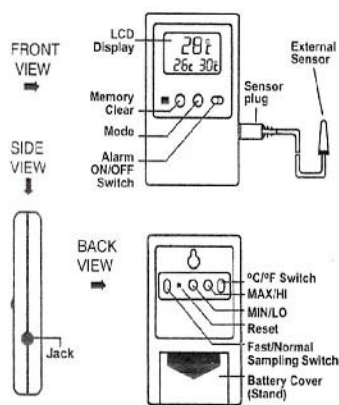

SETTING THE HIGH/LOW ALARM

Press the MODE button until the unit is in the ALARM DISPLAY MODE indicated by the display of current temperature and HI and LO alarm settings.

To set the HIGH temperature alarm limit, press the HI button to advance the display in 1° increments until the desired high temperature is displayed. Press and hold the HI button to rapidly advance the display in 5° increments.

To set the LOW temperature alarm limit, press the LO button to advance the display in 1° increments until the desired low temperature is displayed. Press and hold the LO button to rapidly advance the display in 5° increments.

ALARM

The unit will sound the alarm in both NORMAL DISPLAY MODE and ALARM DISPLAY MODE. Slide the ALARM ON/OFF switch to ON. When the current temperature display rises above the HI set point, or falls below the LO set point, the alarm will sound for 1 minute and issue a 3-

second repeater beep every minute thereafter, for up to 12 hours. The alarm will continue to sound even if the current temperature display returns to an "in range" condition.

To temporarily silence the alarm, press either the HI or LO button on the back of the unit. The unit is still active and the alarm will sound again if the temperature goes out of range. To permanently silence the alarm, slide the ALARM ON/OFF switch to the OFF position.

OPERATION MODES

SUMMIT alarms have two operating modes: NORMAL DISPLAY MODE and ALARM DISPLAY MODE. To change from one mode to another, press the MODE button once.

NORMAL DISPLAY MODE is indicated by the display of current temperature and the MIN (minimum) and MAX (maximum) temperatures. These temperatures relate to external (probe) temperature if the probe is plugged in, and to ambient temperature if the sensor probe is removed.

ALARM DISPLAY MODE is indicated by the display of current temperature and the HI and LO alarm settings. These temperatures relate to external (probe) temperature if the probe is plugged in, and to ambient temperature if the sensor probe is removed.

RESETTING THE UNIT

Use a pointed object to push the RESET button on the back of the unit. It is necessary to reset the unit whenever a change is made to °C/°F temperature or FAST/NORMAL sampling rate, or if the probe sensor is plugged in or removed.

Note: HI/LO temperature alarm settings and MIN/MAX memories will be cleared after resetting the unit.

SELECTING THE SAMPLING RATE

To select normal sampling rate (60 seconds) or fast sampling rate (10 seconds), slide the switch on the back of the unit to NORMAL or FAST.

Note: The unit must be reset after changing the sampling rate. Using the NORMAL sampling rate will extend battery life.

RESETTING MIN/MAX MEMORIES

There are two ways to reset the memories:

1. To reset both Minimum and Maximum memories, press the MEMORY CLEAR button.
2. To reset individual Minimum and Maximum memories, press either the MIN or MAX button (on back of unit) once to reset the respective memory. The other memory will remain unaffected.

Note: You must be in Normal Display Mode to reset the memories.

INSTRUCTIONS FOR INTEGRATED FRAME (SUFFIX 'IF') FOR BUILT-IN APPLICATIONS

Note: The directions below are for installation under a cabinet in a 24 inch cutout space. If you will be using this product in a freestanding application, please skip below, and begin with step A1 in lower half of page.

1. Remove door from chassis by unscrewing 3 screws in top hinge and 2 screws in bottom hinge. Keep screws, discard hinges.
2. Remove top and bottom hinge bushings.
3. Remove frame from door.
4. Attach customer-supplied handle to door panel using countersunk screws.
5. Screw door panel to frame using 14 screws.
6. Slide frame over refrigerator door and attach with 1 screw on each side on center of door.
7. Attach top brace to frame with 1 screw on each side. Attach bottom brace in the same manner.
8. Drill a hole through the top and bottom panel using the braces as a guide with a 1/8" drill bit. Install screws to finish attaching the top and bottom braces securely to the frame.
9. Drill a hole into the door panel from the top and bottom using the braces as a guide with 1/4" drill bit. Do not exceed 5/8" deep. This is the hole that the door will pivot on.
10. Remount the door using the supplied top and bottom hinges.

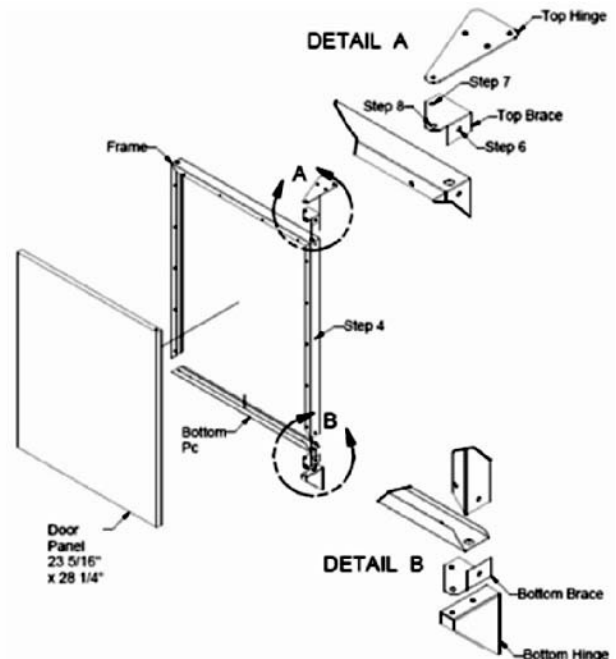

INSTRUCTIONS FOR INTEGRATED FRAME (SUFFIX 'IF') FOR FREESTANDING USE

- A1. Remove door from chassis by unscrewing 3 screws in top hinge and 2 screws in bottom hinge. Keep screws, discard hinges.
- A2. Remove top and bottom hinge bushings.
- A3. Remove frame from door.
- A4. Attach customer-supplied handle to door panel using countersunk screws.
- A5. Screw door panel to frame using 14 screws.
- A6. Slide frame over refrigerator door and attach with 3 screw on each side.
- A7. Install top and bottom hinge bushings.
- A8. Remount the door using the supplied top and bottom hinges.

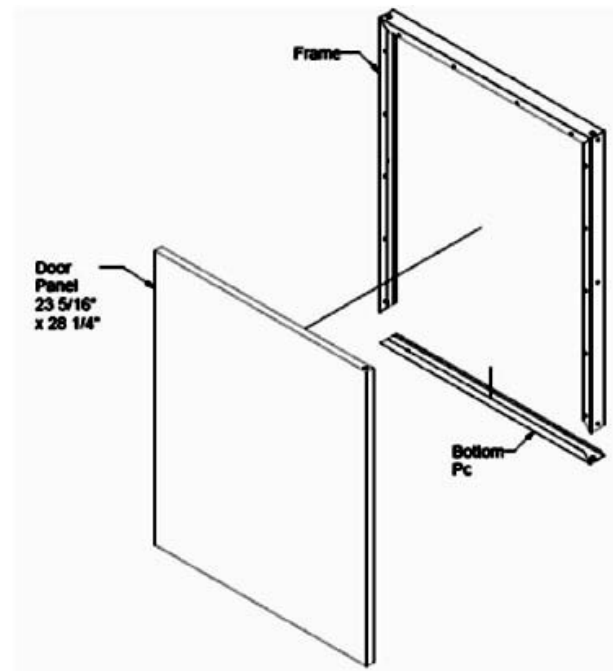

APPLIANCE OPERATION (by Model)

FF6BI – FF7BI – SCR600LOS – SPR7OS – SPR601OS – SCR600BI – SWC6GBI – ALB751 – ALB753B Series

DEFROST SYSTEM, OPERATION AND SHELF ADJUSTMENT – All models of the above series are all-refrigerators, with no freezer compartment and an auto-defrost system. During the compressor operation, ice will build up along the cold rear wall (the evaporator plate is behind the wall). During the compressor's off-cycle, ice will melt, drip down, collect in the trough at the bottom and drain through the small hole into a tray above the compressor, where the compressor's heat will evaporate the water. If you notice excessive ice build-up on the rear wall, try setting the thermostat to a slightly warmer setting; be sure that the gasket is sealing well and that there is no obstruction of the drain hole in the bottom rear of these units. Models with black cabinets include glass shelves. These shelves stop short an inch before the back wall, which is essential for air flow and the automatic defrost system. Do not block with food or containers. All models have removable, easily adjustable shelves. To remove a shelf, simply lift the rear of the shelf out of its locking position and slide the shelf forward. Replace shelves the same way, being sure they lock into place. The thermostat of these units is located at the top on the right hand side as you face the refrigerator. Turn clockwise for colder operation, and counter-clockwise to save energy and increase the temperature. The light on the FF6BI models is controlled by an automatic plunger switch whenever the door is opened. Models with glass doors and flat door liners have a rocker switch to manually turn the light on or off. The light should be kept off when the door is closed to save energy and help keep interior temperatures lower.

BI540 – BI541 – CT67BI – ALB651 – ALB653B – CT66BI – CT66B Series

DEFROST SYSTEM, OPERATION AND SHELF ADJUSTMENT – Models above are refrigerator-freezer combinations with a manual defrost freezer section and an automatic defrost fresh-food section. When ice builds to ½ inch around the freezer, empty the contents of the whole unit and defrost carefully (DO NOT USE SHARP OBJECTS) following directions earlier in this manual. The fresh food section will defrost itself, exactly like the models in the previous section. The freezer in this unit is rated four stars, which makes it suitable for ice-cream and short term storage of meats and other perishable items. For best storage, be sure not to over-pack and assure the freezer door closes fully. Shelves adjust the same as in the section above. Models with black cabinets as well as CT67BI models include glass shelves. These shelves stop short an inch before the back wall, which is essential for air flow and the automatic defrost system. Do not block with food or containers. The thermostat of these units is located at the top on the right hand side as you face the refrigerator. Turn clockwise for colder operation, and counter-clockwise to save energy and increase the temperature. Lights on these units are all controlled by an automatic plunger-type switch.

SCFF55 Series

These units are frost-free freezers with a fan-cooled interior. The cooling is provided by the evaporator module mounted to the top of the unit. Air is circulated through the fan grill at the front of the unit and an outlet at the rear of the unit. Try to keep the air path as free as possible for optimal performance. Normally, no defrosting of these units is needed. There are no user serviceable parts within the evaporator module, so do not tamper with or attempt to move this part. It is part of the sealed refrigeration system. Models with black cabinets include glass shelves. These shelves stop short an inch before the back wall, which is essential for air flow. Do not block with food or containers. All models have removable, easily adjustable shelves. To remove a shelf, simply lift the rear of the shelf out of its locking position and slide the shelf forward. Replace shelves the same way, being sure they lock into place. The light in the SCFF55 models is controlled by a manual rocker switch. Keep the light off when the door is closed for better performance and to save energy. *Models with ice-makers installed do not include an interior light.*

SWC6GBI Series Wine Cellars

These wine cellars are fully automatic defrost (see description of the defrost system under Model FF6BI series above). There is a light in the upper right corner, controlled by a rocker switch. Base models of the SWC6G series have chrome-plated shelves, while some models are equipped with optional flat wire shelves or wooden shelves. For maximum capacity, it is possible to lay wine bottles at the rear of the shelves cross-wise, behind the bottles facing forward. Keep one inch of clearance behind the shelves and the rear wall for air circulation and the efficient operation of the defrost system. Glass doors should be cleaned with non-abrasive glass cleaners, and it is recommended that the interiors be cleaned with only a baking soda / water mix so odors are not left behind that can be absorbed by corks. These models are one temperature zone only, although the lower shelves are normally a few degrees colder than the upper shelves.

APPLIANCE OPERATION (by Model)

BI605FF Series

These units are fully automatic defrost refrigerator-freezers. They utilize a digital thermostat with a built-in defrost-timer (mounted in the kick-plate) to intermittently turn off the refrigeration system long enough for the freezer plate to melt accumulated ice. The melted water is drained out of the appliance through the metal tray below the freezer compartment to a plastic tray above the compressor where the water is evaporated. During the cooling cycles, it is normal to see a small ice accumulation on the freezer floor. Be sure to keep the path for water removal clear and the metal tray properly seated. The digital thermostat will display "DEF" during the defrost function.

The auto-defrost feature adds convenience, but it is not recommended for uses where critical medicine, pharmaceuticals or vaccines need to be kept frozen. A manual or frost-free freezer compartment or a separate freezer is more suitable for these applications. SUMMIT has a full range of such products.

To set the interior temperature, (it should be set only for the fresh food section) follow the instructions for digital thermostats earlier in this manual. Model BI605FF does not include a vegetable crisper as a standard feature.

FS62BI Series

These freezers are manual defrost, commercial freezers capable of operating at -25°C (-13°F). Follow the defrosting instructions found earlier in the booklet, being careful not to use sharp objects to scrape the ice. The cooling coils (part of the sealed refrigeration system) run through each fixed shelf. The drawers are fully removable, and you can operate the freezer without them if desired. However, the drawers contribute to energy efficiency and are best used whenever possible. The thermostat is located on the exterior front of the unit in the face of the tabletop. In some cases, on models with the CSS suffix or models modified for ADA applications, the thermostat is housed on the rear of the unit, near the top. It is convenient to set it prior to installing (many customers will be satisfied with a warmer set-point, which is still colder than many household freezers). Shelf positions in FS62BI models are fixed in position.

OUTDOOR REFRIGERATORS (BRANDED SUMMIT OR OTHER BRANDS)

SPR7OS Series, SPR7OSBI series, SPR601OS Series, SCR600LOS Series and Drawer series

Models for outdoor use all contain the same internal defrost system as the FF7BI series on the prior pages. Your unit may have a light controlled by a rocker switch, an automatic switch or no light. (Drawer units are not equipped with lights.) Read directions earlier in this booklet, specifically on the use of GFCI outdoor cord, location requirements, tip-over brackets for drawer units, drawer removal and replacement and safety. These refrigerators are not designed to operate when exterior temperatures are below 45 degrees F. If you have seasons with temperatures routinely that low, these units should be unplugged, cleaned and stored for the winter. Always leave the door slightly ajar during storage so odors will not build up inside the units. Once a season, when foods are not present (prior to winter storage is ideal), the stainless steel exterior of the units can be lightly coated with WD-40 to restore the luster and protect the finish. A vinyl cover for the SPR7-OS series can be ordered from your dealer or at www.summitapplianceparts.com. Drawer refrigerators and SPR7-OSBI models are suitable for under-counter or built-in applications. SPR7-OS models, and SCR600LOS series and SPR601OS series are intended for free-standing use, and if put under a counter, provisions for adequate air flow must be provided (minimum 1 inch on sides and top and 2 inches at the rear).

FOR BEST PERFORMANCE OF OUTDOOR REFRIGERATORS:

- **KEEP OUT OF DIRECT SUNLIGHT**
- **ALLOW ADEQUATE AIR CIRCULATION**
- **DO NOT USE WITH AN OUTLET OPERATING ON A SWITCH**
- **CHECK GFCI CORD REGULARLY**
- **MINIMIZE DOOR OPENING TIME**
- **ALLOW 24 HOURS TO COOL A FULL LOAD OF ROOM TEMPERATURE BEVERAGES**

WARNING FOR OWNERS OF OUTDOOR APPLIANCES: Be aware that muriatic acid (used for cleaning masonry and in pool care) will damage stainless steel surfaces.

INSTALLING A PANEL INTO A SUMMIT FRAME (“FR” SUFFIX)

On any model that includes suffix “FR” in the model number, and on all models BI540, BI541, ALB651, ALB653B, ALB751 and ALB753B, a two-piece stainless steel frame is mounted on the door. The models can be used without a panel, but to install a panel follow the directions below. (Panel size is 23 1/8” W x 28 1/8” H.)

1. Empty the refrigerator and carefully lay it on its back.
2. Unscrew the small piece of frame from the bottom. For a thin metal panel, use a piece of cardboard as backing.
3. Slide panel into frame, replace the bottom frame and reattach the screws.

BEFORE CALLING FOR SERVICE

Before calling for assistance or service, please check *Troubleshooting*. It may save you the cost of a service call. If you still need help, follow the instructions below. When calling, please know the purchase date and the complete model and serial numbers of your appliance. This information will help us to respond better to your request.

If You Need Replacement Parts

If you need to order replacement parts, we recommend that you use only factory-specified parts. Factory-specified parts will fit right and work right because they are made with the same precision used to build every new SUMMIT® appliance.

- Check the plug, fuse and/or circuit breaker.
- Test the outlet with a lamp.
- Make certain that the outlet used is not controlled by a wall switch. This is more common in outdoor kitchens.
- Be sure the control is not set to **0 (OFF)**.
- On outdoor units, check that the GFCI switch on the line cord is on. If necessary, press the Reset button.
- Read the manual, especially the items under *Troubleshooting*. You may find the answer to your question.

If you don't find the answer in this manual, find the unit model number (on the serial tag) and try our website (www.summitappliance.com) under *Service and Support*, or contact our Customer Service department at **1-800-287-8799**.

Accessories available for your SUMMIT Built-in Under-Counter Models

The following accessories are available at www.summitapplianceparts.com to enhance the beauty or functionality of your new refrigerator or freezer.

| Accessory | Description | Finish | Fits models |
|-----------------------------------|--|-----------------|--|
| Level leg shield | Solid grill that fits below two front level legs and hides the legs. Acts as a base grill extension. | Black | All FF6, FF7, BI540, BI541, FS62, CT66, CT67, SCC6G, SCFF55, SCR600, outdoor models, all drawer units, all models beginning with ALB65 or ALB75 |
| Stainless steel kick-plate | Replaces the standard white or black kick-plate with one in full stainless steel. | Stainless steel | All FF6, FF7, BI540, BI541, FS62, CT66, CT67, SCC6G, SCFF55, SCR600, outdoor models, all drawer units, all models beginning with ALB65 or ALB75 |
| Stainless steel top hinge | Replace the hinge cap and cover with a laser-cut solid stainless steel hinge for a commercial look. | Stainless steel | All FF6, FF7, BI540, BI541, FS62, CT66, CT67, SCC6G, SCFF55, SCR600, outdoor models, all drawer units, all models beginning with ALB65 or ALB75 |
| Stainless steel shelves | Set of stainless steel shelves to replace wire or glass shelves supplied with the unit. | Stainless steel | All FF6, FF7, BI540, BI541, FS62, CT66, CT67, SCC6G, SCFF55, SCR600, outdoor models, all drawer units, all models beginning with ALB65 or ALB75 |
| Keys | Spare keys for models with front push-to-turn locks. | Chrome / black | All FF6L, FF7L, CT66L, BI540L, SCR600L, SCR600BL, SPR70S (Summit brand only), FS62L, SCFF55L, FF7L, SWC6GBL, SPR601OS, ALB651L, ALB751L, ALB753L |

TROUBLESHOOTING

Try the solutions suggested here first to avoid the cost of an unnecessary service call ...

Your refrigerator or freezer will not operate:

- **Has a household fuse blown or circuit breaker tripped, or is the outlet not receiving power or is it switch-controlled?**
Replace the fuse or reset the circuit breaker. Check the outlet with a small appliance you know works.
- **Is the refrigerator or freezer defrosting (on some models)?**
Recheck to see whether the appliance is operating in a few hours. It may regularly run an automatic defrost cycle.

There is water in the defrost drain pan (on some models):

- **Is the appliance defrosting?**
The water will evaporate. It is normal for water to drip into the defrost pan.
- **Is it more humid than normal?**
When it is humid, expect that the water in the defrost pan will take longer to evaporate.

The motor seems to run too much:

- **Is there excessive frost or a package preventing the door from closing?**
Defrost and clean the appliance, or move the package so the door closes properly.
- **Is the room temperature hotter than normal?**
The motor will run longer under warm conditions. At normal room temperatures, your motor will run about 40% to 80% of the time. Under warmer conditions, it will run even more.
- **Has a large amount of food just been added to the appliance?**
Adding a large amount of food warms the refrigerator or freezer. The motor normally will run longer to cool the appliance back down.
- **Is the door closed completely?**
Push the door firmly shut. If it will not shut all the way, see "The door will not close completely" later in this section.
- **Are the condenser coils dirty (on some models)?**
This prevents air transfer and makes the motor work harder. Clean the condenser coils.
- **Is the door gasket sealed all the way around?**
If not, contact a qualified technician.

NOTE: If the problem is not due to any of the above, remember that the compressor on your new appliance will operate longer than your old one due to its high-efficiency motor.

The interior temperature is too warm:

- **Are the air vents blocked?**
This prevents cold air movement. Move objects away from the air vents.
- **Is the door opened often?**
Be aware that the refrigerator or freezer will warm when this occurs. In order to keep the appliance cool, try to get everything you need out of it at once, keep food organized so it is easy to find, and close the door as soon as the food is removed.
- **Has a large amount of food just been added?**
Adding a large amount of food warms the refrigerator or freezer. It can take several hours to return to the normal temperature.

The door will not close completely or is difficult to open:

- **Are food packages blocking the door?**
Rearrange containers so that they fit more tightly and take up less space.
- **Are the shelves and basket out of position (on some models)?**
Put the shelves and basket back into their correct positions.

WARRANTY

Call customer service toll free in the U.S.A. @ 1-800-932-4267 Monday to Friday 9:00 a.m. - 5:00 p.m. (ET).

Order parts online at www.summitappliance.com/support

ONE-YEAR LIMITED WARRANTY

Within the 48 contiguous United States, for one year from the date of purchase, when this appliance is operated and maintained according to instructions attached to or furnished with the product, warrantor will pay for factory specified parts and repair labor to correct defects in materials or workmanship. Service must be provided by a designated service company. Outside the 48 states, all parts are warranted for one year from manufacturing defects. Plastic parts, shelves and cabinets are warranted to be manufactured to commercially acceptable standards, and are not covered from damage during handling or from breakage.

5-YEAR COMPRESSOR WARRANTY

- The compressor is covered for 5 years.
- Replacement does not include labor.

ITEMS WARRANTOR WILL NOT PAY FOR:

1. Service calls to correct the installation of your appliance, to instruct you how to use your appliance, to replace or repair fuses or to correct wiring or plumbing.
2. Service calls to repair or replace appliance light bulbs or broken glass shelves. Consumable parts (such as filters) are excluded from warranty coverage.
3. Damage resulting from accident, alteration, misuse, abuse, fire, flood, acts of God, improper installation, installation not in accordance with electrical or plumbing codes, or use of products not approved by warrantor.
4. Replacement parts or repair labor costs for units operated outside the United States.
5. Repairs to parts or systems resulting from unauthorized modifications made to the appliance.
6. Expenses for travel and transportation for product service in remote locations.
7. The removal and reinstallation of your appliance if it is installed in an inaccessible location or is not installed in accordance with published installation instructions.

DISCLAIMER OF IMPLIED WARRANTIES; LIMITATION OF REMEDIES

CUSTOMER'S SOLE AND EXCLUSIVE REMEDY UNDER THIS LIMITED WARRANTY SHALL BE PRODUCT REPAIR AS PROVIDED HEREIN. IMPLIED WARRANTIES, INCLUDING WARRANTIES OF MERCHANTABILITY OR FITNESS FOR A PARTICULAR PURPOSE, ARE LIMITED TO ONE YEAR. WARRANTOR SHALL NOT BE LIABLE FOR INCIDENTAL OR CONSEQUENTIAL DAMAGES. SOME STATES DO NOT ALLOW THE EXCLUSION OR LIMITATION OF INCIDENTAL OR CONSEQUENTIAL DAMAGES, OR LIMITATIONS ON THE DURATION OF IMPLIED WARRANTIES OF MERCHANTABILITY OR FITNESS, SO THESE EXCLUSIONS OR LIMITATIONS MAY NOT APPLY TO YOU. THIS WARRANTY GIVES YOU SPECIFIC LEGAL RIGHTS AND YOU MAY ALSO HAVE OTHER RIGHTS, WHICH VARY FROM STATE TO STATE.

WARNING! This product may contain chemicals known to the state of California to cause cancer or birth defects or other reproductive harm. For more information, visit: www.summitappliance.com/prop65

Chemicals known by the manufacturer to be present in this product in concentrations higher than threshold limits: NONE.

SUMMIT
Felix Storch, Inc.
770 Garrison Avenue
Bronx, NY 10474

Phone: (718) 893-3900
Fax: (718) 842-3093
Web Site:
www.summitappliance.com