

# Haier®

## TFT-LCD TV OWNER'S MANUAL

Please READ this manual carefully before operating your TV, and keep it for future reference.

# Haier

# Haier

**MODELS :**  
L26B1120  
L32B1120  
L42B1180

The Haier logo consists of a solid grey square with the word "Haier" written in white, sans-serif font inside it.

Haier

# Contents

Safety and warnings.....	2-3
Introduction.....	4
Stand installation guide.....	5
Installation.....	6-9
Remote Control.....	10
Operation.....	11-15
Trouble Shooting.....	16
Warranty.....	17

**IMPORTANT SAFETY INSTRUCTION**

- 1) Read these instructions.
- 2) Keep these instructions.
- 3) Heed all warnings.
- 4) Follow all instructions.
- 5) Do not use this apparatus near water.
- 6) Clean only with dry cloth.
- 7) Do not block any ventilation openings, install in accordance with the instructions.
- 8) Do not install near any heat sources such as radiations, heat registers, stoves, or other apparatus (including amplifiers) that produce heat.
- 9) Do not defeat the safety purpose of the polarized plug. If the provided plug does not fit into your outlet, consult an electrician for replacement of the obsolete outlet.
- 10) Protected the power cord from being walked on or pinched particularly at plugs, convenience receptacles, and the point where they exit from the apparatus.
- 11) Only use attachments/accessories specified by the manufacturer.
- 12) Unplug this apparatus during lightning storms or when unused for long periods of time.
- 13) Refer all servicing to qualified service personnel. Servicing is required when the apparatus has been damaged in any way, such as power-supply cord or plug is damaged, liquid has been spilled or objects have fallen into the apparatus, the apparatus has been exposed to rain or moisture, does not operate normally, or has been dropped.
- 14) Mains plug is used as the disconnect device, the disconnect device shall remain readily operable.
- 15) The ventilation should not be impeded by covering the ventilation openings with items, such as newspapers, table-cloth, curtains, etc.
- 16) No naked flame sources, such as lighted candles, should be placed on the apparatus.
- 17) Attention should be drawn to the environmental aspects of battery disposal.
- 18) The use of apparatus in moderate climate.
- 19) The apparatus shall not be exposed to dripping or splashing and that no objects filled with liquids, such as vases, shall be placed on the apparatus.



The symbol indicates that dangerous voltages constituting a risk of electric shock are present within this unit.



The symbol indicates that there are important operating and maintenance instructions in the literature accompanying this unit.

**WARNING:**

To reduce the risk of fire or electric shock, do not expose this apparatus to rain or moisture.

**WARNING:**

The batteries shall not be exposed to excessive heat such as sunshine, fire or the like.

**WARNING:**



The excessive sound pressure from earphones and headphones can cause hearing loss.



This symbol indicates that this product incorporates double insulation between hazardous mains voltage and user accessible parts. When servicing use only identical replacement parts.



This marking indicates that this product should not be disposed with other household wastes throughout the EU. To prevent possible harm to the environment or human health from uncontrolled waste disposal, recycle it responsibly to promote the sustainable reuse of material resources. To return your used device, please use the return and collection systems or contact the retailer where the product was purchased. They can take this product for environmental safe recycling.

	<b>CAUTION</b> RISK OF ELECTRIC SHOCK DO NOT OPEN!	
<b>CAUTION</b>		
TO REDUCE THE RISK OF ELECTRIC SHOCK, DO NOT REMOVE COVER (OR BACK). NO USER SERVICEABLE PARTS INSIDE. REFER SERVICING TO QUALIFIED SERVICE PERSONNEL.		

Haier is committed to safely recycling electronic products and product materials. Please check for a local recycling location in the United States at: [1800RECYCLING.COM](http://1800RECYCLING.COM) or call 1.800.RECYCLING.

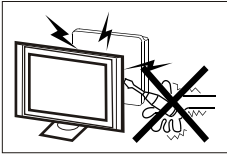

High voltages are used in the operation of this television receiver. Do not open the cabinet. Refer servicing to qualified service personnel.

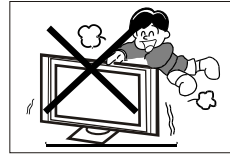

Never stand on, lean on, or suddenly push the television or its stand. You should pay special attention to children. Serious injury may result if it falls.

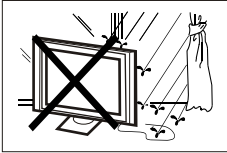

To prevent fire or electrical shock hazard, do not expose the television receiver to rain or moisture.

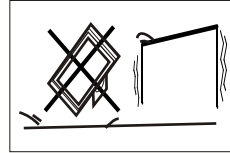

Do not place your television on an unstable cart, stand, shelf or table. Serious injury to an individual and/or damage to the television may result if it falls.



Do not drop or push objects into the television cabinet slots or openings. Never spill any kind of liquid on the television receiver.

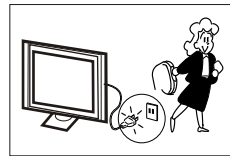

When the television receiver is not used for an extended period of time, it is advisable to disconnect the AC power cord from the AC outlet.



Do not block the ventilation holes on the back cover of the TV. Adequate ventilation is essential to prevent failure of electrical components.

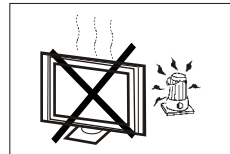

Avoid exposing the television receiver to direct sunlight and other sources of heat. Do not stand the television receiver directly on other products which give off heat, e.g. video cassette players and audio amplifiers. Do not place naked flame sources, such as lighted candles on or near the television.

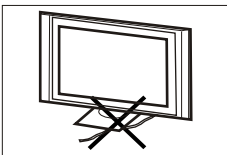

Do not trap the power supply cord under the television receiver's stand.

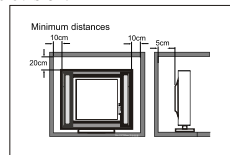

If the television is to be built into a compartment or similar enclosure, the minimum distances must be maintained. Heat build-up can reduce the life of your television, and can also be dangerous.

**Main features**

- Integrated ATSC TV tuner for HDTV broadcast reception
- High brightness provides a vivid and brilliant picture
- Deeper blacks and brighter whites with high contrast
- Wide Screen aspect ratio (16:9) for a complete home theater experience
- HDMI input for true digital connection
- VGA port for connection to PC
- Built-in stereo speaker system
- Full-function Remote Control

**Accessories**

Power Cable.....	1
Infrared Remote Control.....	1
User's Manual .....	1
Battery(AAA).....	2

**Main parameter**

Viewing Picture Size (diagonal)	26 inches	32 inches	42 inches
Resolution:	1366x768	1366x768	1920x1080
Power consumption:	80W	135W	240W
Audio Output Power (THD ≤ 7%):	2x5W	2x8W	2x8W
Input Power Voltage:	AC 100V-240V 50/60Hz		
Aspect Ratio:	16:9		
TV System:	ATSC Digital system and NTSC Analog system		
Video Signal System:	NTSC		
Receiving Channel:	Cable :1-135/ Air: 2-69 (ATV&DTV)		
High-Definition Multimedia Interface (HDMI) Input	x 2		
YCb(Pb)Cr(Pr) Input	x 1		
Composite Video Input	x 2		
Analog RGB (VGA) Input	x 1		
Audio Input	x 3		
Headphone Output	x 1		
Coaxial Output	x 1		
USB Input	x 1		
Horizontal definition (TV line)	Composite Video Input ≥350 Video Input ≥400 YCb(Pb)Cr(Pr) ≥400		

## STAND INSTALLATION GUIDE

This STAND INSTALLATION GUIDE is provided to help you easily install the stand. Please carefully follow Step 1 through Step 3.

### 1 Open the box and find the parts

Open the box and find the following parts.

- Stand x1 pc
- Screws x4 pcs

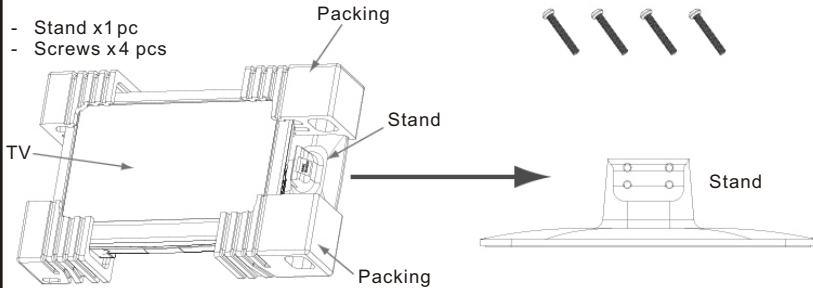

### 2 Place the Stand on the TV

1. Place the TV with the display side down on a table or desk (flat, totally clean surface).

2. Place the Stand on the TV as shown below.

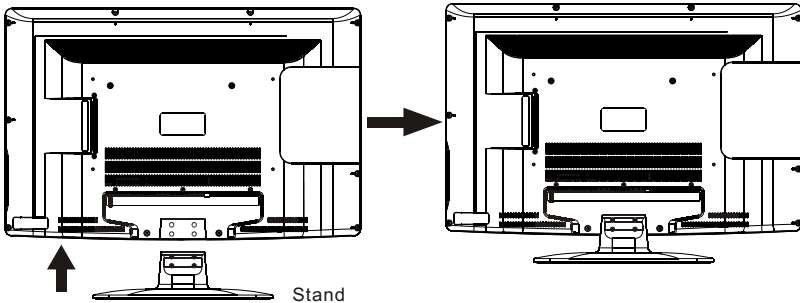

### 3 Secure the Stand to the TV

Secure the Stand to the TV by using the 4 supplied screws.

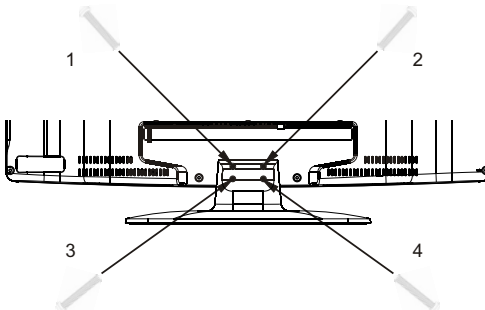

Front panel

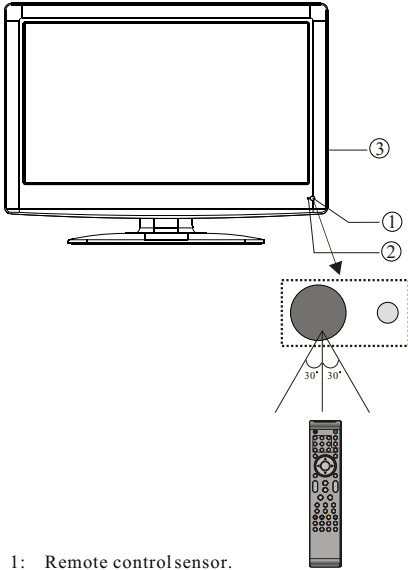

- 1: Remote control sensor.
- 2: Indicator LED: GREEN ● POWER ON.  
RED ● STANDBY.
- 3: Side panel keys

Side panel

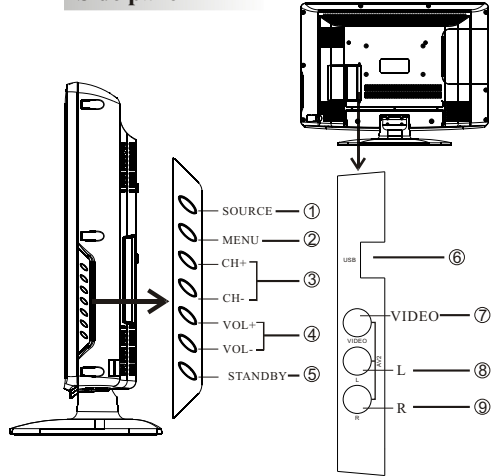

- 1. **SOURCE:** Display the input source menu.
- 2. **MENU:** Display main MENU.
- 3. **CH+/CH-:** In TV mode, press "CH+" or "CH-" to change the channel up and down. In MENU mode, press "CH+" or "CH-" to select items in standby mode, press "CH+" or "CH-" to turn on the TV.
- 4. **VOL+/VOL-:** Adjust sound level. In MENU mode, press "VOL+" or "VOL-" to adjust the item that you selected.
- 5. **STANDBY:** Press this button to turn the unit ON from STANDBY mode. Press it again to turn the set back to STANDBY.
- 6. **USB INPUT**
- 7. **VIDEO INPUT**
- 8. **AUDIO INPUT-L**
- 9. **AUDIO INPUT-R**

REAR AV INPUT/OUTPUT

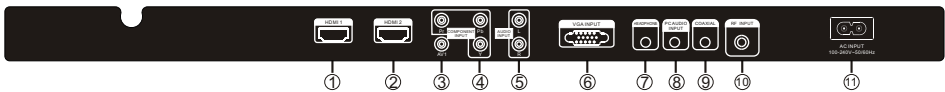

- 1. HDMI1 Input
- 2. HDMI2 Input
- 3. Composite Video Input
- 4. Component Video (YPbPr) Input
- 5. Audio Input
- 6. VGA Port (PC Input)
- 7. Headphone Output
- 8. PC Audio Input
- 9. Coaxial
- 10. Antenna Socket
- 11. AC Power Socket

Note: 1. Composite video input and component video input share the audio input.  
 2. When a DVI connection is used on the HDMI 1 Input, use "PC Audio" for the audio signal input.  
 3. When a DVI connection is used on the HDMI 2 Input, use "YPbPr Audio" for the audio signal input.

**PC**

**STEPS:**

Be sure both the TV and computer are powered off.

1. Connect a VGA and audio cable.
2. Connect the power cord.
3. Turn on the TV and switch to VGAmode.
4. Turn on the PC.

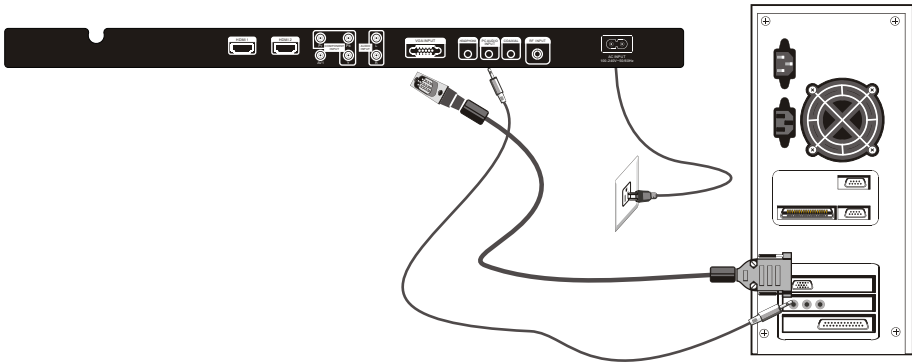

**PRESET MODE**

	<b>RESOLUTION</b>	<b>V.Freq.(Hz)</b>	<b>H.Freq.(KHz)</b>
1	720*400	70	31.47
2	640*480	60	31.47
3	640*480	75	37.50
4	800*600	60	37.88
5	800*600	75	46.88
6	1024*768	60	48.36
7	1024*768	70	56.48
8	1024*768	75	60.02
9	1280*1024	60	63.98
10	1280*1024	75	80.00



ANTENNA

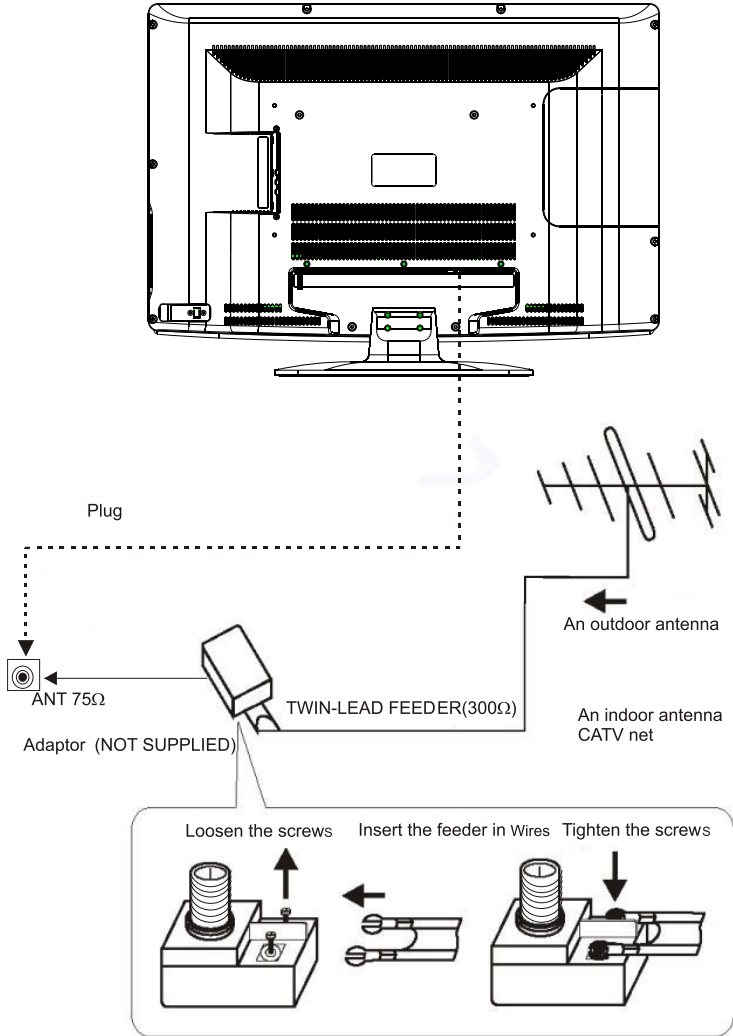

Note:  
 Aerial connections: IEC (female).  
 Input impedance: 75Ω unbalanced.

**AV EQUIPMENT**

There are two HDMI ports located on the back of your TV. You can connect a Blu-ray player, DVD player, or other video equipment through these ports. There is one component (Y, Pb, Pr) and two composite (AV) video input located on the back of your TV. You can connect a VCR, cable box, or other video equipment to these jacks. Please see the diagram below. You may also need to refer to the owner's manual of the device that you are trying to connect.

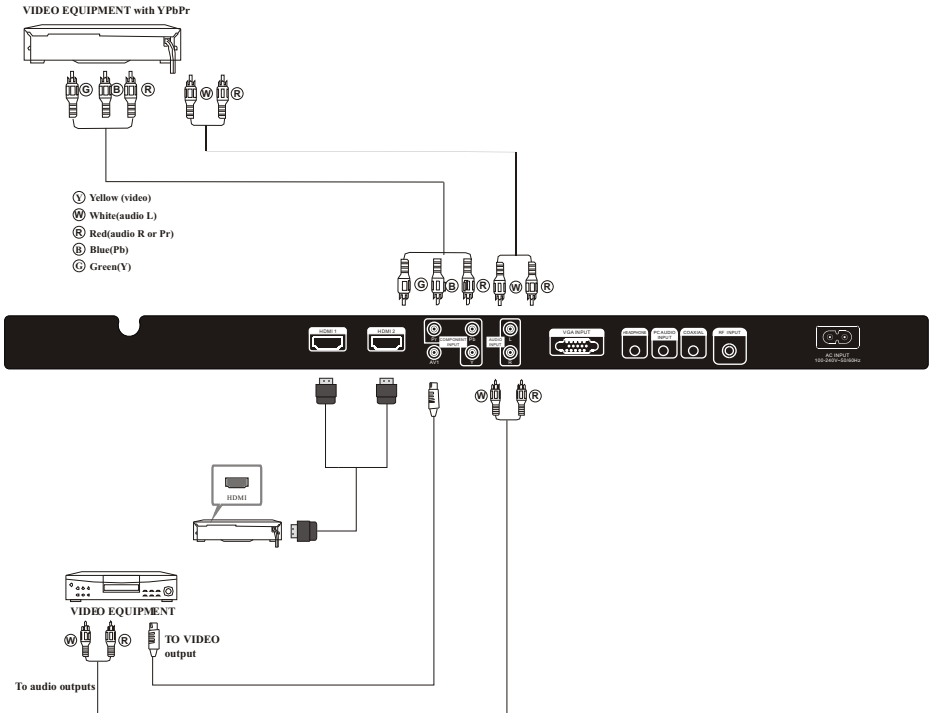

It can be connected to the following appliances: VCR, multi disc player, DVD, camcorder, video game or stereo system, etc..... There is a composite (AV) video input and a USB port located on the side of the TV. You can use this AV input to conveniently connect devices that you may frequently connect and disconnect, such as a camcorder.

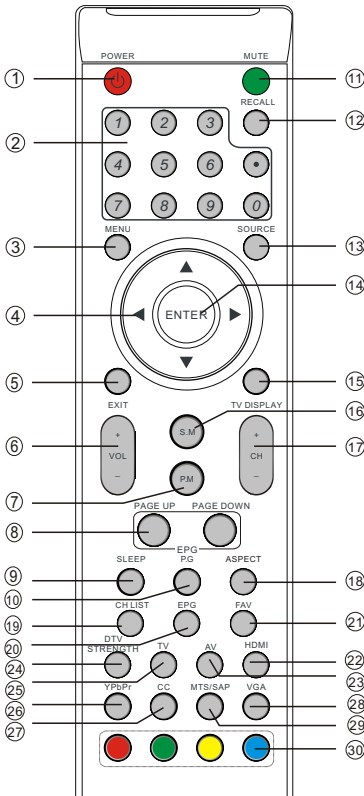

- 1: **POWER**  
Press to power ON/OFF (standby) the TV.
- 2: **NUMBER KEY**  
Press to enter the TV channel number and select a channel (Press "\*" to choose the sub-channel).
- 3: **MENU**  
Press to open the on screen display (OSD) menu or return to the previous menu.
- 4: **CURSOR**  
When the OSD menus displayed on-screen, use these buttons as the up, down, left, right and ENTER buttons to adjust the various options in the OSD menu.
- 5: **EXIT**  
Press to exit the OSD menu.
- 6: **VOL +/-**  
Press VOL+ or VOL- to adjust the volume.
- 7: **P.M**  
Press repeatedly to select a picture mode: Vivid, Standard, Sports, Movie, or Custom.
- 8: **PAGE DOWN/PAGE UP**  
In EPG mode, use this key to page up/down the EPG information.
- 9: **SLEEP**  
Press repeatedly to set the sleep timer (off / 5 / 10 / 15 / 30 / 45 / 60 / 90 / 120 / 180 / 240 minutes). The TV will automatically turn off after the selected amount of time passes.
- 10: **P.G**  
Press to go to the Parental Control settings menu.
- 11: **MUTE**  
Press to switch the sound ON/OFF.
- 12: **RECALL**  
Press to switch between the current and previously viewed channel.
- 13: **SOURCE**  
Press to display or exit the TV input source menu.
- 14: **ENTER**  
Press to confirm a selection.
- 15: **TV DISPLAY**  
Press to show the information about the current input source.
- 16: **S.M**  
Press repeatedly to switch audio modes: Standard, News, Music, Theater, Sports or Custom.
- 17: **CH+/CH-**  
Press CH+ or CH- to browse through the TV channels.
- 18: **ASPECT**  
Press to change the picture aspect ratio.
- 19: **CH LIST**  
Press to display the channel list.
- 20: **EPG**  
Press to display the DTV Electronic Program Guide.
- 21: **FAV**  
Press to display the favorite channels list.
- 22: **HDMI**  
Press to directly switch to HDMI input mode.
- 23: **AV**  
Press to directly switch to AV (composite) input mode.
- 24: **DTV STRENGTH**  
Press to display the DTV signal strength.
- 25: **TV**  
Press to directly switch to TV mode.
- 26: **YPbPr**  
Press to directly switch to component input mode.
- 27: **CC**  
Press to turn on or off the closed captions.
- 28: **VGA**  
Press to directly switch to VGA (PC input) mode.
- 29: **MTS/SAP**  
Press to activate the NTSC TV sounds, such as Stereo, SAP or Monotone, and audio languages of DTV.
- 30: **COLOR KEYS**  
Reserved keys

## Insert Batteries Into the Remote Control

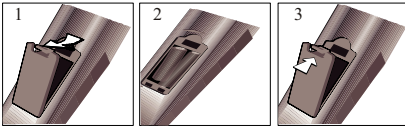

1. Remove the battery cover.
2. Insert the 2 AAA 1.5V batteries making sure the polarity (+ or -) of the batteries matches the polarity marks inside the unit.
3. Close the battery cover.  
Replace with new batteries when the TV set begins to show the following symptoms:  
Operation is unsteady or erratic. Sometimes the TV set does not function with the Remote Control.

### Remark:

- 1) Alkaline Batteries Recommended.
- 2) Remove batteries when they are exhausted or if the remote control is not to be used for a long time.

### 1. PICTURE MENU

The first item of the MENU is the PICTURE MENU. This menu provides several video adjustment options for fine tuning the video display. Press ▼▲ to select, press ◀▶ to adjust, press MENU to exit.

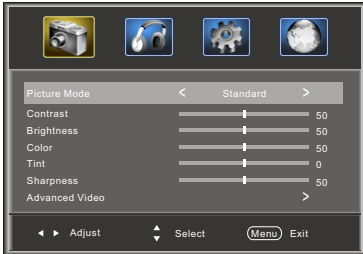

Note:

If you want to adjust contrast, brightness, color, and sharpness, the picture mode must be set to "Custom".

Advanced Video:

Press ▼▲ to select Advanced Video, press ▶, and the screen shown below will be displayed.

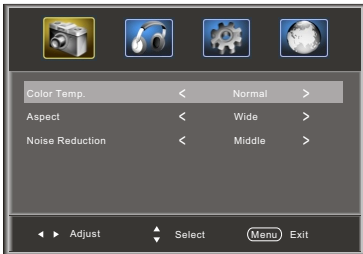

### 2. AUDIO menu

The second item of the MENU is the AUDIO MENU. You can adjust sound options here.

Press ▼▲ to select, press ◀▶ to adjust, press MENU to exit.

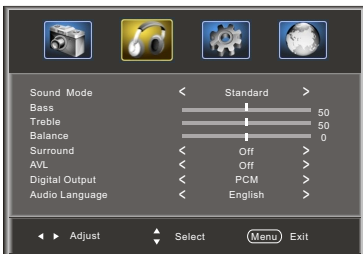

Note:

The Audio language option is only available for ATSC (DTV) programs.

### 3. SETUP MENU

The third item of the MENU is the SETUP MENU. You can set system settings here.

Press ▼▲ to select, press ◀▶ to adjust, press MENU to exit.



Note:

Restore Default: Reset all settings to the factory default value.

After changing TV channel name in the menu, the operating "reset to default", the channels label name could not be reset manual.

#### 3.1. Parental Controls:

Press ▼▲ to select Parental Controls, press ▶, and the screen shown below will be displayed.

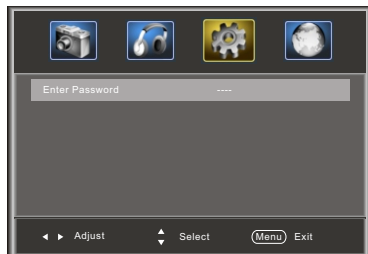

Input the password, and you will enter the Parental Control menu. The factory default password is 0000.

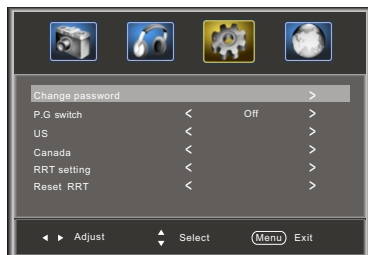

**Change Password:**

Press **▶**, and the screen shown below will be displayed.

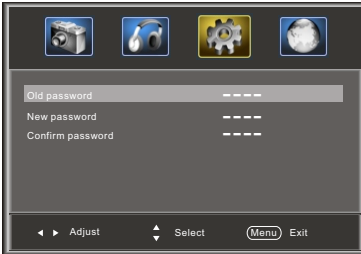

- 1). Old password: Input the old password
- 2). New password: Input the new password
- 3). Confirm password: Input the new password again

**P.G switch:**

When the Parental Control is ON, the options shown below can be adjusted.

US: Press **▶**, and the screen shown below will be displayed.



- 1): TV: Press **▶**, and the screen shown below will be displayed.



Rating	Content	Content				
		FV (Fantasy violence)	V (Violence)	S (Sexual situation)	L (Adult language)	D (Sexually suggestive dialog)
Suggested age	TV-Y (All children)					
	TV-Y7(Direct to order children)	X				
	TV-G(General audience)					
	TV-PG(Parental Guidance suggested)		X	X	X	X
	TV-14(Parents strongly cautioned)		X	X	X	X
	TV-MA(Mature audience only)		X	X	X	

Press the ENTER key to lock/unlock Parental Controls.

- 2). MPAA: switch the movie-rating control level: N/A, G, PG, PG-13, R, NC-17, X.

Rating	Description
G	General audiences, All Ages admitted
PG	Parental Guidance suggested. Some material may not be Suitable for children.
PG-13	Parents strongly cautioned. Some material may be Inappropriate for children under 13.
R	Restrict. Under 17 requires accompanying parent or adult guardian (age varies in some jurisdictions).
NC-17	No one 17 and under admitted.
X	X is an orderrating that is unified with NC-17 but maybe encoded in the data of order movies.

Canada: Press **▶**, and the screen shown below will be displayed.

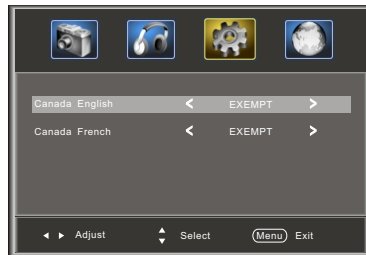

- 1): Canada English: switch the English-rating control level: EXEMPT, C, C8+, G, PG, 14+, 18+.

Rating	Description
E	Exempt: Includes news, sports, documents and other information programming: talk shows, music videos, and variety programming.
C	Children: Intended for younger children under the age of 8 years. Pays careful attention to themes that could threaten their sense of security and well-being.
CS+	Children over 8 years old: Contains no portrayal of violence as the preferred, acceptable, or only way to resolve conflict; nor encourage children to imitate dangerous acts which they may see on the screen.
G	General: Considered acceptable for all age groups. Appropriate viewing for the entire family, contains very little violence, physical, verbal or emotional.
PG	Parental Guidance: Intended for a general audience, but may not be suitable for younger children (under the age of 8) because it could contain controversial themes or issues.
14+	Over 14 Years: Could contain themes where violence is one of the dominant elements of the story line, but it must be integral to the development of plot or character. Language usage could be profane and nudity, present within the context of the theme.
18+	Adults: Intended for viewers 18 years and older and might contain depictions of violence, which while related to the development of plot, character or themes, are intended for adult viewing. Could contain graphic language and portrayals of nudity.

2). Canada French: switch the French-rating control level: E, G, 8ANS+, 13ANS+, 16ANS+, 18ANS+.

Rating	Description
E	Exempt programming
G	General: All ages and children, contains minimal direct violence, but may be integrated into the plot in a humorous or unrealistic manner.
8ans+	General but inadvisable for young children: May be viewed by a wide public audience, but could contain scenes disturbing to children under 8 who cannot distinguish between imaginary and real situations. Recommended for viewing with parental guidance.
13ans+	Over 13 years: Could contain scenes of frequent violent scenes and intense violence.
16ans+	Over 16 years: Could contain frequent violent scenes and violence.
18ans+	Over 18 years: Only for adult viewing. Could contain frequent violent scenes and extreme violence.

RRT setting: in ATSC digital TV mode, it could be adjusted

Reset RRT: Press **▶**, and the screen shown below will be displayed.



### 3.2 Timer

You can adjust timers here.

Press **▼▲** to select, press **◀▶** to adjust, press **MENU** to exit.

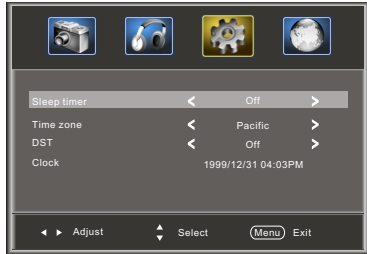

Sleep Timer: You can set the sleep timer.

Note:

Time zone, DST and Clock are available in ATSC mode, and the Clock can't be adjusted.

### 3.3 Closed Caption: switch the closed caption mode.

Press **▼▲** to select Closed Caption, press **▶**, and the screen shown below will be displayed.



1): Advanced selection: only available in ATSC mode.

2): Option: You can edit the closed caption options.

Press **▶**, and the screen shown below will be displayed.

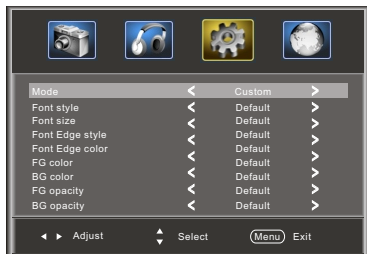

NOTE: Only available in ATSC mode.

### 3.4 Menu Settings

You can adjust Menu Settings here.

Press ▼▲ to select, press ◀▶ to adjust, press MENU to exit.



### 3.5 VGA Settings: Only available in VGA (PC input) mode.

Press ▼▲ to select VGA Settings, press ▶, and the screen shown below will be displayed.

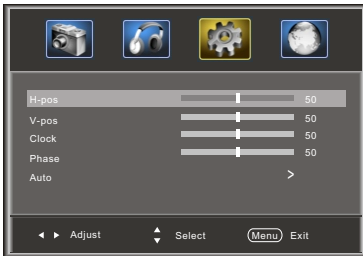

- 1). H-Pos: Adjust the horizontal position of the screen.
- 2). V-Pos: Adjust the vertical position of the screen.
- 3). Clock: Finetune the screen width.
- 4). Phase: Finetune the phase of the screen. Usually you don't need to adjust this item option.
- 5). Auto: Auto adjust to fit the screen.

### 4. Channel MENU

The fourth item of the MENU is the Channel MENU.

You can adjust digital and analog TV Channel. Press ▼▲ to select, press ◀▶ to adjust.

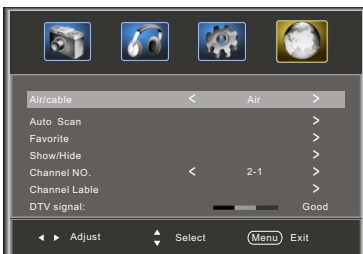

- 1). Air/Cable: Select Air TV signal or Cable TV signal.
- 2). Auto Scan: If it's the first time you use the TV, you should scan all the TV channels first.

Press the ▶ to confirm, and the screen shown below will be displayed.



Select "YES" and press the **ENTER** to confirm, and the screen shown below will be displayed, which indicates that the auto search is progressing.



- 3). Favorite: Press ◀▶ to add/delete favorite channels.
- 4). Show/Hide: Press the ENTER button to display or hide channels.
- 5). Channel NO. : Display the current channel number. Press ◀▶ to change the channel.
- 6). Channel label: Press ▲▼ to edit the current channel name.
- 7). DTV signal: Display DTV signal strength. It can't be selected and adjusted.

## 5. Multimedia MENU

If you select the storage source. You can use the Multimedia Menu to display JPEG pictures and play MP3 music.

### 1. Select a Photo

The screen shown below will be displayed.

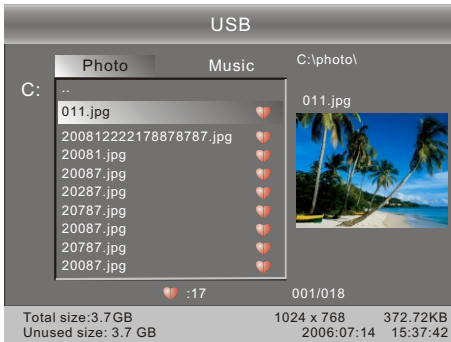







Use **◆** select the .Jpg files or folders, press ENTER to play, press EXIT to stop playing or go to the previous menu.

### 2. Select Music

















The screen shown below will be displayed.

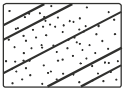

Use **◆** select the .MP3 files or folders, press ENTER to play, press EXIT to go to the previous menu.

-  : play
-  : pause
-  : stop
-  : fast backward
-  : previous
-  : next
-  : fast forward
-  : repeat all
-  : random play



Trouble phenomenon Symptom		Inspection Check
Picture	Audio	
 <p>Snow</p>	 <p>Noise</p>	antenna position, direction or connection
 <p>Ghost</p>	 <p>Normal audio</p>	antenna position, direction or connection
 <p>Interference</p>	 <p>Noise</p>	electronic equipment, car/ motorcycle, fluorescent light
 <p>Normal Picture</p>	 <p>Mute</p>	Volume (check if mute is activated or if the audio system connections are not correct)
 <p>No picture</p>	 <p>Mute</p>	Power cord is not inserted Power switch is not opened Contrast and brightness/volume setup Press standby key on the remote control for inspecting
 <p>No color</p>	 <p>Normal audio</p>	Color control
 <p>Picture breaking up</p>	 <p>Normal audio or weak</p>	Retune channel
 <p>No color</p>	 <p>Noise</p>	TV system

The LCD TV panel is built with very high precision technology giving you fine picture details in vibrant color. Occasionally, a few non-active pixels may appear on the screen as a fixed point of red, green, blue, black or white. Please note this does not affect the performance of the product.

## Warranty

This Haier brand product, when shipped in its original container, will be free from defective workmanship and materials, and agrees that it will, at its option, either repair the defect or replace the defective product with a new or re-manufactured equivalent, for parts or labor for the periods set forth below:

This warranty does not apply to the appearance of the product or the exterior of the product, which has been damaged or defaced, altered or modified in design or construction. It does not apply to the additional excluded items set forth below:

The warranty commences on the date the item was purchased and the original purchase receipt must be presented to the authorized service center before warranty repairs are rendered.

The limited warranty described herein is in addition to whatever implied warranties may be granted to purchasers by law. **ALL IMPLIED WARRANTIES INCLUDING THE WARRANTIES OF MERCHANTABILITY AND FITNESS FOR USE ARE LIMITED TO THE PERIOD(S) FROM THE DATE OF PURCHASE SET FORTH BELOW.** Some states do not allow limitations on how long an implied warranty lasts, so the above limitation may not apply to you.

Neither the sales personnel of the seller nor any other person is authorized to make any warranties other than those described herein, or to extend the duration of any warranties beyond the time period described herein on behalf of Haier.

The warranties described herein shall be the sole and exclusive warranties granted by Haier and shall be the sole and exclusive remedy available to the purchaser. Correction of defects in the manner and for the period of time described herein, shall constitute complete fulfillment of all abilities and

Responsibility of Haier to the purchaser with respect to the product, and shall constitute full satisfaction of all claims, whether based on contract, negligence, strict liability or otherwise. In no event shall Haier be liable, or in any way responsible for any damages or defects in the product which were caused by repairs or attempted repairs performed by anyone other than an authorized service center or dealer; nor shall Haier be liable, or in any way responsible for incidental or consequential economic or property damage. Some states do not allow the exclusion of incidental or consequential damages, so that above exclusion may not apply to you.

**THIS WARRANTY GIVES YOU SPECIFIC LEGAL RIGHTS. YOU MAY ALSO HAVE OTHER RIGHTS WHICH VARY FROM STATE TO STATE.**

Warranty period for this product is one year parts and labor. Additional items excluded from warranty coverage: non-rechargeable batteries. What to do to obtain service or to obtain product literature, accessories, supplies or customer assistance: Simply call 1-877-337-3639. Be sure to have proof of purchase.

**Haier®**