

DV331AE\*  
DV331AG\*

# Gas and Electric Dryer user manual

imagine the possibilities

Thank you for purchasing this Samsung product.  
To receive more complete service or accessory  
parts, please register your product at or contact  
[www.samsung.com/register](http://www.samsung.com/register)

1-800-SAMSUNG (726-7864)



# features

## 1. Extra Large Capacity

Ultra drying capabilities are at your fingertips! Now you can dry extra-large loads. Our ultra large 7.3 cu.ft. capacity dryer circulates more air through your clothes, drying them faster for a wrinkle-free result.

## 2. Steam cycle

This cycle sprays a small amount of water into the dryer drum after several minutes of tumbling with heat. It reduces bad odors from clothing that are difficult to remove when washing with water, and also reduces wrinkles.

## 3. Sanitize course

This course allows you to sanitize garments by permeating high temperature heat deep into the fabric during the drying cycle. Use this course to keep your bedding and curtains clean. When selecting this cycle, 99.9% of all bacteria is eliminated through high temperature heat. Use this cycle for clothing, bedding, towels, or other items needing sanitization.

This certification is conducted by NSF International, an independent third-party testing and certification organization.



NSF Protocol P154  
Sanitization Performance of  
Residential Clothes Dryers

## 4. Various Drying Cycles & Fuzzy Logic Algorithm

Simply turn the Jog Dial to select one of the 9 automatic drying cycles, including normal, heavy duty and towels, or let the Fuzzy Logic Control measure the degree of dampness and automatically set the drying time. Precision drying has never been easier than with Samsung.

## 5. Time Saving

Our cycles are designed with you in mind. All our dryers are designed to dry your clothes in less time... just 42 minutes! Giving you time for more important things in life.

## 6. Energy Saving

Samsung dryers are super energy efficient. You can dry up to 3.01 pounds of laundry with 1kWh. Also, both the large capacity and Fuzzy Logic Control save energy by automatically drying your clothes the most efficient way.

## 7. Easy Reversible Door

Our dryers will fit just about anywhere. The direction of our easy reversible door can be changed with just four screws.

## 8. Pedestal with Storage Drawers

An optional 15" pedestal is available to raise the dryer for easier loading and unloading. It also offers a built-in storage drawer that can hold a 100 oz. bottle of detergent

## 9. Stacking (MODEL NO: SK-5A/XAA)

Samsung's Washers and Dryers can be stacked to maximize usable space.



The Dryer legs need to be removed to stack the Washer and Dryer. You can purchase an optional stacking kit from your Samsung retailer.

## 10.4-way Vent (electric model only : DV331AE\*)

You can install the exhaust vent in the following four (4) positions: back, either side, bottom.

# safety instructions

Congratulations on your new Samsung Dryer. This manual contains valuable information on the installation, use, and care of your appliance. Please take the time to read this manual to take full advantage of your dryer's many benefits and features.



## WARNING - Risk of Fire

- Clothes dryer installation must be performed by a qualified installer.
- Install the clothes dryer according to the manufacturer's instructions and local codes.
- Do not install a clothes dryer with flexible plastic venting materials. If flexible metal (foil type) duct is installed, it must be of a specific type identified by the appliance manufacturer as suitable for use with clothes dryers. Flexible venting materials are known to collapse, be easily crushed, and trap lint. These conditions will obstruct clothes dryer airflow and increase the risk of fire.
- To reduce the risk of severe injury or death, follow all installation instructions.

## WHAT YOU NEED TO KNOW ABOUT SAFETY INSTRUCTIONS

Warnings and Important Safety Instructions in this manual do not cover all possible conditions and situations that may occur. It is your responsibility to use common sense, caution, and care when installing, maintaining, or operating your dryer.

Always contact your manufacturer about problems or conditions you do not understand.

## IMPORTANT SAFETY SYMBOLS AND PRECAUTIONS

 WARNING	Hazards or unsafe practices that may result in <b>severe personal injury or death</b> .
 CAUTION	Hazards or unsafe practices that may result in <b>minor personal injury or property damage</b> .
 CAUTION	Follow the information in this manual to minimize the risk of fire or explosion or to prevent property damage, personal injury, or death. Do not store or use gasoline or other flammable vapors and liquids near this or any other appliance.
 Do NOT attempt.	
 Do NOT disassemble.	
 Do NOT touch.	
 Follow directions explicitly.	
 Unplug the power plug from the wall socket.	
 Make sure the machine is grounded to prevent electric shock.	
 Call the service center for help.	

## SAVE THESE INSTRUCTIONS

# safety instructions



**WARNING:** To reduce the risk of fire, electric shock, or injury to persons when using your appliance, follow basic precautions, including the following:

1. Read all instructions before using this appliance.
2. Do not dry articles that have been previously cleaned in, washed in, soaked in, or spotted with gasoline, dry-cleaning solvents, or other flammable or explosive substances, as they give off vapors that could ignite or explode.
3. Do not allow children to play on or in the appliance. Close supervision of children is necessary when the appliance is used near children.
4. Before the appliance is removed from service or discarded, remove the door to the drying compartment.
5. Do not reach into the appliance if the drum is moving.
6. Do not install or store this appliance where it will be exposed to the weather.
7. Do not tamper with controls.
8. Do not repair or replace any part of the appliance or attempt any servicing unless specifically recommended in the user-maintenance instructions or in published user-repair instructions that you understand and have the skills to carry out.
9. Do not use fabric softeners or products to eliminate static unless recommended by the manufacturer of the fabric softener or product.
10. Clean lint screen before or after each load.
11. Do not use heat to dry articles containing foam rubber or similarly textured rubber-like materials.
12. Keep area around the exhaust opening and adjacent surrounding areas free from the accumulation of lint, dust, and dirt.
13. The interior of the appliance and exhaust duct should be cleaned periodically by qualified service personnel.
14. Do not place items exposed to cooking oils in your dryer. Items contaminated with cooking oils may contribute to a chemical reaction that could cause a load to catch fire.

## SAVE THESE INSTRUCTIONS

## WHAT TO DO IF YOU SMELL GAS:

---

- Do not try to light any appliance.
- Do not turn on the appliance.
- Do not touch any electrical switch.
- Do not use any phone in your building.
- Clear the room, building or area of all occupants.
- Immediately call your gas supplier from a neighbor's phone. Follow the gas supplier's instructions.
- If you cannot reach your gas supplier, call the fire department.

Installation and service must be performed by a qualified installer, service agency, or the gas supplier.



Read all instructions before using the appliance.



To reduce the risk of fire or explosion:

- Do not dry items that have been previously cleaned, washed, soaked, or spotted with gasoline, dry cleaning solvents, or other flammable or explosive substances. They emit vapors that could ignite or explode. Any material that has been in contact with a cleaning solvent or flammable liquids or solids should not be placed in the dryer until all traces of these flammable liquids or solids and their fumes have been removed. There are many highly flammable items used in homes, such as acetone, denatured alcohol, gasoline, kerosene, some liquid household cleaners, some spot removers, turpentine, waxes, and wax removers
- Items containing foam rubber (may be labeled latex foam) or similarly textured rubber-like materials must not be dried on a heat setting. Heated foam rubber materials can, under certain circumstances, produce fire by spontaneous combustion.

Do not allow children or pets to play on, in, or in front of the appliance. Close supervision is necessary when the appliance is used near children and pets.

Before discarding or removing your dryer from service, remove the door to the drying compartment to prevent children or animals from becoming trapped inside.



Do not reach into the appliance when the drum is moving.

Do not install or store this appliance where it will be exposed to the weather.

Do not tamper with controls.



Do not repair, replace, or attempt to service any part of the appliance unless specifically recommended in the user-repair instructions and you understand and have the skills to carry those out.

Do not use fabric softeners or products to eliminate static unless recommended for dryer use by the manufacturer of the fabric softener or product.

Clean the lint screen before or after each load.

Keep the area around the exhaust opening and surrounding areas free from lint, dust, and dirt.

## SAVE THESE INSTRUCTIONS

# safety instructions

The interior of the dryer and exhaust duct should be cleaned periodically by qualified service personnel.

-  This appliance must be properly grounded. Never plug the power cord into a receptacle that is not grounded adequately and in accordance with local and national codes. See installation instructions for grounding this appliance.

Do not sit on top of the dryer.

-  Because of continuing product improvements, Samsung reserves the right to change specifications without notice. For complete details, see the Installation Instructions packed with your product before selecting cabinetry, making cutouts, or beginning installation.

-  Ensure pockets are free from small irregularly shaped hard objects, foreign material, etc. ie. coins, knives, pins, etc. These objects could damage your dryer.

Do not wash clothing with large buckles, buttons, or other heavy metal or solid things.

-  Gas leaks may occur in your system, resulting in a dangerous situation.

Gas leaks may not be detected by smell alone.

Gas suppliers recommend you purchase and install a UL-approved gas detector.

Install and use in accordance with the manufacturer's instructions.

Do not place items in your dryer that have been spotted or soaked with vegetable oil or cooking oil. Even after being washed, these items may contain significant amounts of these oils.

Residual oil on clothing can ignite spontaneously. The potential for spontaneous combustion increases when items containing vegetable oil or cooking oil are exposed to heat. Heat sources such as your dryer can warm these items, allowing an oxidation reaction in the oil to occur. Oxidation creates heat. If this heat cannot escape, the items can become hot enough to catch fire. Piling, stacking, or storing these kinds of items may prevent heat from escaping and can create a fire hazard.

All washed and unwashed fabrics that contain vegetable oil or cooking oil can be dangerous. Washing these items in hot water with extra detergent will reduce, but not eliminate, the hazard. Always use the Cool Down cycle for these items to reduce their temperature. Never remove these items from the dryer hot or interrupt the drying cycle until the items have run through the Cool Down cycle. Never pile or stack these items when they are hot.

## **CALIFORNIA SAFE DRINKING WATER AND TOXIC ENFORCEMENT ACT**

This act requires the governor of California to publish a list of substances known to the state to cause cancer, birth defects, or other reproductive harm and requires businesses to warn customers of potential exposure to such substances.

Gas appliances can cause minor exposure to four of these substances, namely benzene, carbon monoxide, formaldehyde, and soot, caused primarily by the incomplete combustion of natural gas or LP fuels.

Properly adjusted dryers will minimize incomplete combustion. Exposure to these substances can be minimized further by properly venting the dryer to the outdoors.

## **SAVE THESE INSTRUCTIONS**

# contents

---

## **INSTALLING YOUR DRYER**

8

- 8 Tools needed for installation
- 8 See Dryer Exterior
- 9 Ducting requirements
- 10 Important to installer
- 10 Location considerations
- 10 Alcove or closet installation
- 12 Mobile home installation
- 12 Exhausting
- 13 Gas requirements
- 14 Electrical requirements
- 14 Grounding
- 15 Electrical connections
- 16 Connecting the inlet hose
- 18 Replacement parts and accessories
- 18 Installation
- 21 Final installation checklist
- 22 Dryer Exhaust Tips
- 23 Door Reversal

## **OPERATING INSTRUCTIONS, TIPS**

24

- 24 Overview of the control panel
- 27 Child lock
- 27 Drum Light
- 27 Changing The Language
- 28 Rack Dry(optional)
- 29 Clean the lint filter
- 29 Load the dryer properly
- 29 Getting started

## **CARE AND CLEANING**

30

- 30 Control Panel
- 30 Tumbler
- 30 Stainless Steel Tumbler
- 30 Dryer Exterior
- 30 Dryer Exhaust System

## **SPECIAL LAUNDRY TIPS**

31

- 31 Special laundry tips

## **TROUBLESHOOTING**

32

- 32 Check these points if your dryer...
- 34 Information codes

## **APPENDIX**

35

- 35 Fabric care chart
- 36 Protecting the environment
- 36 Declaration of conformity
- 36 Specifications
- 37 Cycle chart

# installing your dryer

## TOOLS NEEDED FOR INSTALLATION

Hire a professional to install this dryer properly. If there is a service call performed as a result of poor setup, adjustment, and connection, it is considered the responsibility of the installer. If you install the dryer, you are responsible.

Make sure you have everything necessary for proper installation.

1. A GROUNDING ELECTRICAL OUTLET is required. See Electrical Requirements.
2. A POWER CORD for electric dryers (except Canada).
3. GAS LINES (if a gas dryer) must meet national and local codes.
4. EXHAUST SYSTEM – must be rigid metal or flexible stiff-walled metal exhaust ducting. See the exhaust requirements on pages 8-10.

## SEE DRYER EXTERIOR

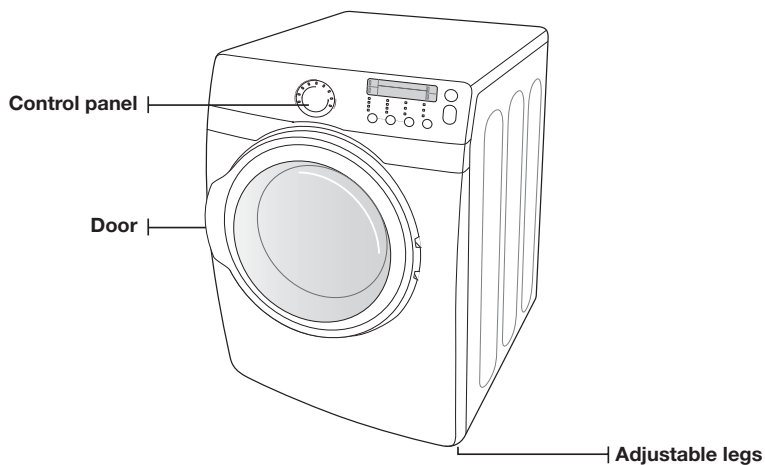

“Y”-connector



Short inlet hose



Rubber Washer

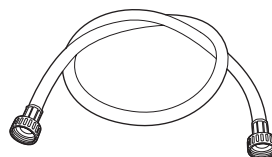



Long inlet hose



## DUCTING REQUIREMENTS

- Use a 4-inch (10.2 cm) diameter rigid aluminum or rigid galvanized steel duct.
- Do not use a smaller duct.
- Ducts larger than 4 inches (10.2 cm) in diameter can result in increased lint accumulation. Lint accumulation should be cleaned regularly.
- If a flexible metal duct must be used, use the type with a stiff sheet metal wall. Do not use a flexible duct with a thin foil wall. Serious blockage can result if the flexible metal duct is bent too sharply.
- Never install any type of flexible duct in walls, ceilings, or other concealed spaces.
- Only a rigid or flexible metal duct should be used for exhausting.
- Keep the exhaust duct as straight and short as possible.
- Secure joints with duct tape. Do not use screws.
- DO NOT EXHAUST DRYER INTO ANY WALL, CEILING, CRAWL SPACE, OR CONCEALED SPACE OF A BUILDING, GAS VENT, OR ANY OTHER COMMON DUCT OR CHIMNEY. THIS COULD CREATE A FIRE HAZARD FROM LINT EXPELLED BY THE DRYER.
- A plastic flexible duct can kink, sag, be punctured, reduce airflow, extend drying times, and affect dryer operation.
- Exhaust systems longer than recommended can extend drying times, affect machine operation, and may collect lint.
- The exhaust duct should end with an exhaust hood with a swing-out damper to prevent back drafts and entry of wildlife. Never use an exhaust hood with a magnetic damper.
- The hood should have at least 12 inches (30.5 cm) of clearance between the bottom of the hood and the ground or other obstruction. The hood opening should point down.
- Never install a screen over the exhaust outlet.
- To avoid lint buildup, do not exhaust the dryer directly into a window well. Do not exhaust under a house or porch.
- If exhaust ductwork must run through an unheated area, the duct should be insulated and slope slightly down towards the exhaust hood to reduce condensation and lint buildup.
- Inspect and clean the interior of the exhaust system at least once a year. Unplug the power cord before cleaning.
- Check frequently to be sure the exhaust hood damper opens and closes freely.
- Check once per month, and clean at least one time per year. Note: If clothes are not getting dry, then check ducting for obstructions.

ELECTRIC AND GAS DRYER				
Weather Hood Type				
Recommended			Use only for short-run installation	
 <p>4" (10.16 cm)</p>			 <p>2.5" (6.35 cm)</p>	
No. of 90° elbows	Rigid	Metallic Flexible*	Rigid	Metallic Flexible*
0	24.4 m (80 ft.)	12.4 m (41 ft.)	22.6 m (74 ft.)	10.1 m (33 ft.)
1	20.7 m (68 ft.)	11.2 m (37 ft.)	18.9 m (62 ft.)	8.8 m (29 ft.)
2	17.4 m (57 ft.)	10.1 m (33 ft.)	15.5 m (51 ft.)	7.6 m (25 ft.)
3	14.3m (47 ft.)	9.0 m (29 ft.)	12.5 m (41 ft.)	6.5 m (21 ft.)

\* Do not use non-metallic flexible duct.

# installing your dryer

If the new dryer is installed into an existing exhaust system you must make sure:

- The exhaust system meets all local, state, and national codes.
- That a flexible plastic duct is not used.
- To Inspect and clean all lint buildup from inside the existing duct.
- The duct is not kinked or crushed.
- The exhaust hood damper opens and closes freely.

The static pressure in any exhaust system must not exceed 0.83 inches of water column, or be less than 0.

This can be measured with the dryer running with a manometer at the point where the exhaust duct connects to the dryer. A no-heat setting should be used. The dryer tumbler should be empty and the lint filter clean.

## IMPORTANT TO INSTALLER

Please read the following instructions carefully before installing the dryer. These instructions should be kept for future reference.



REMOVE THE DOOR FROM ALL DISCARDED APPLIANCES TO AVOID THE DANGER OF A CHILD SUFFOCATING.

## LOCATION CONSIDERATIONS

The dryer should be located where there is enough space at the front for loading the dryer, and enough space behind for the exhaust system. This dryer is factory-ready for rear exhaust. To exhaust out the bottom or the right or the left, use the accessory exhaust kit. Instructions are included with the kit. It's important to make sure the room has enough fresh air. The dryer must be located where there is no air-flow obstruction.

On gas dryers, adequate clearance as noted on the data plate must be maintained to ensure adequate air for combustion and proper dryer operation.

THE DRYER MUST NOT BE INSTALLED OR STORED IN AN AREA WHERE IT WILL BE EXPOSED TO WATER AND/OR WEATHER. THE DRYER AREA IS TO BE KEPT CLEAR OF COMBUSTIBLE MATERIALS, GASOLINE, AND OTHER FLAMMABLE VAPORS AND LIQUIDS. A DRYER PRODUCES COMBUSTIBLE LINT. THE AREA AROUND THE DRYER SHOULD BE KEPT LINT-FREE.

## ALCOVE OR CLOSET INSTALLATION



The dryer must be exhausted to the outside to reduce the risk of fire when installed in an alcove or closet.

- No other fuel-burning appliance should be installed in the same closet as the dryer.
- WARNING: To reduce the risk of fire, this dryer MUST BE EXHAUSTED TO THE OUTDOORS. See EXHAUST INFORMATION section.
- The closet front must have two unobstructed air openings for a combined minimum total area of 72 in<sup>2</sup> with 3" minimum clearance on the top and bottom. A louvered door with equivalent space clearance is acceptable.

## MINIMUM CLEARANCES FOR CLOSET AND ALCOVE INSTALLATIONS:

Sides - 1 In.(2.5 cm)

Top - 17 In.(43.2 cm)

Rear - 5 In. (12.7 cm)

Closet Front - 2 In. (5.1 cm)

If the washer and dryer are installed together, the closet front must have at least a 72 in<sup>2</sup> (465cm<sup>2</sup>) unobstructed air opening. Your washer alone does not require a specific air opening.

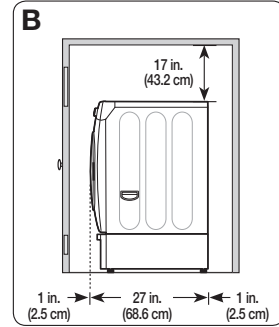
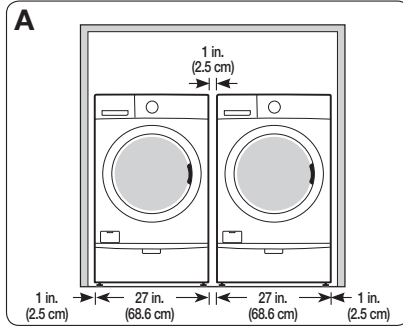

A. Recessed area

B. Side view - closet or confined area

## With optional pedestal base or stacking kit

### Required Dimensions for Installation With Pedestal

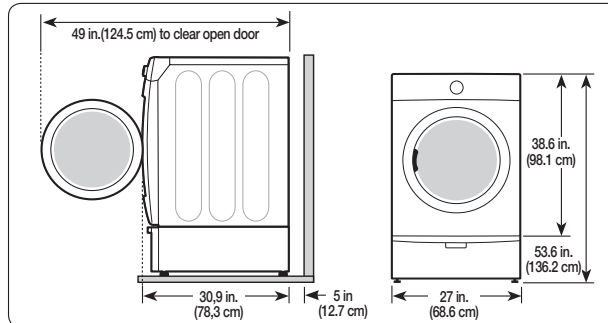

### Required Dimensions for Installation With Stacking Kit

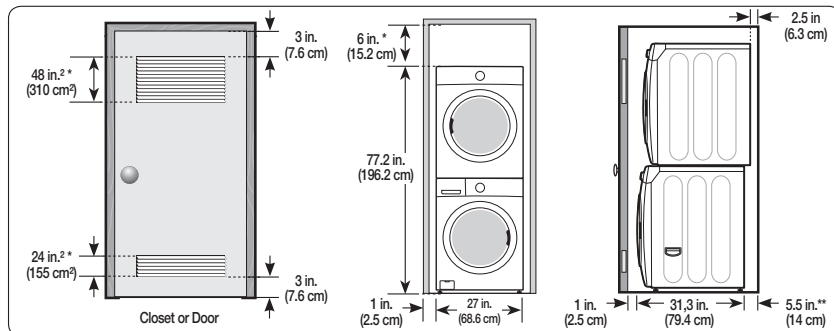

\* Required spacing

\*\* External exhaust elbow requires additional space.

# installing your dryer

## MOBILE HOME INSTALLATION

The installation of the dryer in mobile homes must conform to the Manufactured Home Construction and Safety Standard Title 24 CFR, Part 3280 (formerly the Federal Standard for Mobile Home Construction and Safety, Title 24, HUD (Part 280), 1975) for the United States) or CSA Standards Z240 (for Canada).

When installing a dryer in a mobile home, provisions for anchoring the dryer to the floor must be made.

Locate an area that has adequate fresh air.

A minimum of 72 in<sup>2</sup> (465 cm<sup>2</sup>) of unobstructed space is required.

Call 1-800-SAMSUNG(726-7864) for information on purchasing the Floor Anchoring Kit as an accessory.

All mobile home installations must be exhausted to the outside with the exhaust duct termination securely fastened to the mobile home structure, using materials that will not support combustion.

The exhaust duct may not terminate underneath the mobile home.

See Exhausting section for more information.

## EXHAUSTING

Exhausting the dryer to the outside will prevent large amounts of lint and moisture from being blown into the room.

### In the United States:

- All dryers must be exhausted to the outside.
- The required exhaust duct is 4inch(102mm) in diameter.
- Only those foil-type flexible ducts, if any, specifically identified for use with the appliance by the manufacturer and that comply with the Outline for Clothes Dryer Transition Duct, Subject 2158A, shall be used.
- The duct shall not be assembled with screws or other fastening means that extend into the duct and catch lint.

### In Canada:

- Only those foil-type flexible ducts, if any, specifically identified for use with the appliance by the manufacturer shall be used.
- All dryers must be exhausted to the outside.
- The exhaust duct should be 4inch (102mm) in diameter.

### Outside the U.S. and Canada:

- Refer to the local codes.



The dryer must be exhausted to the outside to reduce the risk of fire when installed in an alcove or closet.

**NEVER USE A PLASTIC OR NON-METAL FLEXIBLE DUCT.**

If your existing ductwork is plastic, non-metal, or combustible, replace it with metal.

Use only a metal exhaust duct that is non-flammable to ensure containment of exhaust air, heat, and lint.

## GAS REQUIREMENTS

Use only natural or LP (liquid propane) gases.

**THE INSTALLATION MUST CONFORM WITH LOCAL CODES, OR IN THE ABSENCE OF LOCAL CODES, WITH THE NATIONAL FUEL GAS CODE ANSI/Z223.1, LATEST REVISION (FOR THE UNITED STATES), OR WITH THE CAN/CGA-B149 INSTALLATION CODES (FOR CANADA).**

Gas dryers are equipped with a burner vent for use with natural gas. If you plan to use your dryer with LP (liquid propane) gas, it must be converted for safe and proper performance by a qualified service technician. A 1/2" (1.27 cm) gas supply line is recommended and must be reduced to connect to the 3/8" (1 cm) gas line on your dryer. The National Fuel Gas Code requires that an accessible, approved manual gas shut-off valve be installed within 6" of your dryer.

**Gas dryers installed in residential garages must be raised 18 inches (46 cm) above the floor.**

Additionally, a 1/8" (0.3 cm) N.P.T. (National Pipe Thread) plugged tapping, accessible for test gauge connection, must be installed immediately upstream of your dryer's gas supply connection.

Your dryer must be disconnected from the gas supply pipe system during any pressure testing of the system.

**DO NOT** reuse old flexible metal gas lines. Flexible gas lines must be design certified by the American Gas Association (CGA in Canada).



- Any pipe joint compound used must be resistant to the action of any liquefied petroleum gas.
- As a courtesy, most local gas utilities will inspect a gas appliance installation.

**GAS IGNITION** – Your dryer uses an automatic ignition system to ignite the burner. There is no constant burning pilot.

### Commonwealth of Massachusetts installation instructions

Your dryer must be installed by a licensed plumber or gas fitter. A "T" handle manual gas valve must be installed in the gas supply line to your dryer. If a flexible gas connector is used to install your dryer, the connector must have a maximum length of 3' (36").



- Gas leaks may occur in your system, creating a dangerous situation.
- Gas leaks may not be detected by smell alone.
- Gas suppliers recommend you purchase and install a UL-approved gas detector.
- Install and use in accordance with manufacturer's instructions.

# installing your dryer

## ELECTRICAL REQUIREMENTS

 Wiring diagram is located on the back of the dryer.



- Improper connection of the equipment grounding conductor can result in a risk of electric shock. Check with a qualified electrician or serviceman if you are in doubt as to whether your dryer is properly grounded. Do not modify the plug provided with your dryer – if it doesn't fit the outlet, have a proper outlet installed by a qualified electrician.
- To prevent unnecessary risk of fire, electrical shock, or personal injury, all wiring and grounding must be done in accordance with local codes, or in the absence of local codes, with the National Electrical Code, ANSI/NFPA No. 70-Latest Revision (for the U.S.) or the Canadian Electrical Code CSA C22.1 – Latest Revisions and local codes and ordinances. It is your responsibility to provide adequate electrical services for your dryer.
- All gas installations must be done in accordance with the national Fuel Code ANSI/Z2231 – Latest Revision (for the U.S.) or CAN/CGA – B149 Installation Codes – Latest Revision (for Canada) and local codes and ordinances.

## GROUNDING

This dryer must be grounded. In the event of malfunction or breakdown, the ground will reduce the risk of electrical shock by providing a path of least resistance for the electrical current.



### Gas models

Your dryer has a cord with an equipment-grounding conductor and a grounding plug.

The plug must be plugged into an appropriate outlet that is properly installed and grounded in accordance with all local codes and ordinances.

Do not modify the plug provided with your dryer – if it doesn't fit the outlet, have a proper outlet installed by a qualified electrician.

**NEVER CONNECT GROUND WIRE TO PLASTIC PLUMBING LINES, GAS LINES, OR HOT WATER PIPES.**



### Electric models

Your dryer has a cord with an equipment-grounding conductor and a grounding plug, sold separately.

The plug must be plugged into an appropriate outlet that is properly installed and grounded in accordance with all local codes and ordinances.

Do not modify the plug provided with your dryer – if it doesn't fit the outlet, have a proper outlet installed by a qualified electrician.

If a power cord is not used and the electric dryer is to be permanently wired, the dryer must be connected to a permanently grounded metal wiring system, or an equipment grounding conductor must be run with the circuit conductors and connected to the equipment grounding terminal.

## ELECTRICAL CONNECTIONS

---

Before operating or testing, follow all grounding instructions in the Grounding section. An individual branch (or separate) circuit serving only your dryer is recommended. DO NOT USE AN EXTENSION CORD.

### Gas models – U.S. and Canada

---

A 120 volt, 60 Hz AC approved electrical service, with a 15-ampere fuse or circuit breaker is required.

### Electric models – U.S. only

---

Most U.S. dryers require a 120/240 volt, 60 Hz AC approved electrical service. Some require 120/208 volt, 60 Hz approved electrical service. The electric service requirements can be found on the data label located behind the door. A 30-ampere fuse or circuit breaker on both sides of the line is required.

- If a power cord is used, the cord should be plugged into a 30-ampere receptacle.
- The power cord is NOT provided with U.S. electric model dryers.

#### IMPORTANT:

When local codes allow, the dryer electrical supply may be connected by means of a new power supply cord kit, marked for use with a dryer, that is U.L. listed and rated at a minimum of 120/240 volts, 30-ampere with three No. 10 copper wire conductors terminated with closed loop terminals, open-end spade lugs with turned up ends, or with tinned leads.

- Do not reuse a power supply cord from an old dryer. The power cord electric supply wiring must be retained at the dryer cabinet with a suitable UL-listed strain relief.
- Grounding through the neutral conductor is prohibited for (1) new branch-circuit installations, (2) mobile homes, (3) recreational vehicles, and (4) areas where local codes prohibit grounding through the neutral conductor. (Use 4-prong plug for 4 wire receptacle, NEMA type 14-30R.)

### Electric models – Canada Only

---

- A 120/240 volt, 60 Hz AC approved electrical service fused through a 30-ampere fuse or circuit breaker on both sides of the line is required.
- All Canadian models are shipped with the power cord attached. The power cord should be plugged into a 30-ampere receptacle.



 It is not permissible to convert a dryer in Canada to 208 volts.

# installing your dryer

## CONNECTING THE INLET HOSE

### Method1

The dryer must be connected to the cold water faucet using the new inlet hoses. Do not use old hoses.

1. If space permits, attach the brass female end of the “Y” connector to the cold water faucet.
2. Turn the cold water faucet off.
3. Attach the straight end of long hose to “Y” connector.
4. Using pliers, tighten the coupling with an additional two-thirds turn.
-  Do not overtighten, as it may damage the coupling.
5. Attach angled end of long hoses to fill the valve at the bottom of the dryer's rear frame. Screw on coupling by hand until it is seated on fill valve connector.
6. Using pliers, tighten the coupling with an additional two-thirds turn.
-  Do not overtighten, as it may damage the coupling.
7. Check that the water faucets are on.
8. Check for leaks around “Y” connector, faucets and hoses.

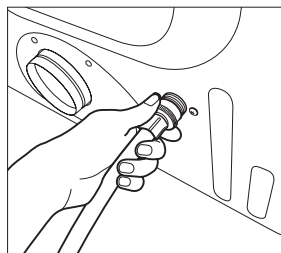
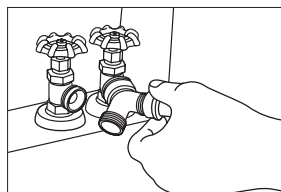





## Method2

The dryer must be connected to the cold water faucet using the new inlet hoses. Do not use old hoses.

1. If "Y" connector cannot be attached directly to the cold water faucet, the short hose must be used.
2. Turn the cold water faucet off.
3. Attach short inlet hose to cold water faucet.  
Screw on coupling by hand until it is seated on the faucet.
4. Using pliers, tighten the coupling with an additional two-thirds turn.

 Do not overtighten, as it may damage the coupling.

5. Attach "Y" connector to brass male end of small hose.  
Screw on coupling by hand until it is seated on connector.
6. Using pliers, tighten the coupling with an additional two-thirds turn.

 Do not overtighten, as it may damage the coupling.

7. Attach angled end of long hoses to the fill valve at the bottom of the dryer rear frame. Screw on coupling by hand until it is seated on fill valve connector.

8. Using pliers, tighten the coupling with an additional two-thirds turn.

 Do not overtighten, as it may damage the coupling.

9. Check that the water faucets are on.

10. Check for leaks around "Y" connector, faucets and hoses.

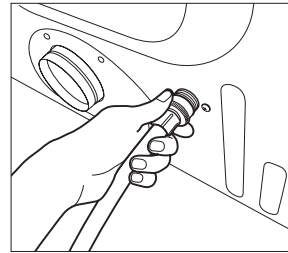
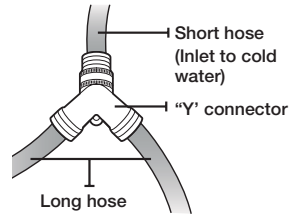

# installing your dryer

## REPLACEMENT PARTS AND ACCESSORIES

If your dryer requires replacement parts or accessories, contact the dealer from whom you purchased your dryer or the SAMSUNG customer care center at 1-800-SAMSUNG(726-7864).

## INSTALLATION

Gather the required tools and parts before starting the installation.  
Read and follow the instructions provided with any tools listed here.

### Tools and Parts



Pliers

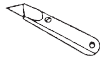

Cutting knife

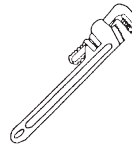

Pipe wrench (gas only)

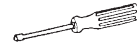

Nut drivers



Level



Phillips Screwdriver



Duct tape

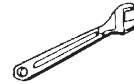



Wrench

For proper installation, we recommend that you hire a professional. To install:

1. Move your dryer to an appropriate location for installation. Consider installing the dryer and washer side-by-side, to allow access to gas, electrical, and exhaust connections. Lay two of the carton cushion-tops on the floor. Tip your dryer on its side so it will lay across both cushion-tops.
2. Set your dryer back in an upright position.
3. To ensure that the dryer provides optimal drying performance, it must be level. To minimize vibration, noise, and unwanted movement, the floor must be a perfectly level, solid surface.

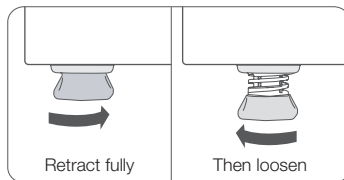
-  To set the dryer to the same height as the washer, fully retract the leveling feet by turning them counterclockwise, then loosen the legs by turning them clockwise



-  Adjust the leveling feet only as much as necessary to level the dryer. Extending the leveling feet more than necessary can cause the dryer to vibrate.

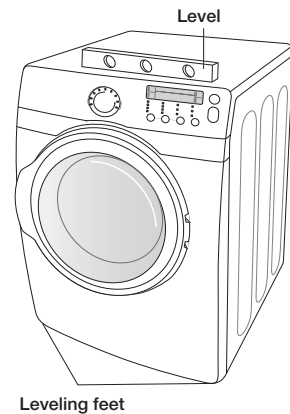

4. Review the Exhausting section before installing the exhaust system. Install the ductwork from your dryer to the exhaust hood. The crimped end of the duct sections must point away from your dryer. DO NOT use sheet metal screws when assembling ducting. These joints should be taped.  
**Never use plastic flexible exhaust material.**  
Tip for tight installations: install a section of exhaust system to your dryer before putting it in place. Use duct tape to secure this section to your dryer, but do not cover ventilation slots at the back of the unit in the dryer cabinet.
5. Review Electrical Requirements section.  
BEFORE OPERATING OR TESTING, follow the grounding instructions in the Grounding section.

### U.S. MODELS:

**IMPORTANT** – All U.S. models are produced for a **3-WIRE SYSTEM CONNECTION**.

The dryer frame is grounded to the neutral conductor at the terminal block.

A **4-WIRE SYSTEM CONNECTION** is required for new or remodeled construction, mobile homes, or if local codes do not permit grounding through neutral. If the 4-wire system is used, the dryer frame cannot be grounded to the neutral conductor at the terminal block. Refer to the following instructions for 3- and 4-WIRE SYSTEM CONNECTIONS.

Remove the terminal block cover plate.

Insert the power cord with a UL-listed strain relief through the hole provided in the cabinet near the terminal block.



A strain relief must be used.

Do not loosen the nuts already installed on the terminal block. Be sure they are tight.  
Use a 3/8" (1cm) deep well socket.

# installing your dryer

## 6. Review Gas Requirements section.

Remove the pipe thread protective cap.

Apply pipe joint compound or about 1 1/2 wraps of Teflon tape over all threaded connections.

 Pipe joint compound must be resistant to the action of any liquefied petroleum gas.

Connect the gas supply to your dryer.

An additional fitting is required to connect the 3/4" (1.9 cm) female thread end of a flexible connector to the 3/8" (1 cm) male threaded end on the dryer.

Securely tighten the gas line fitting over threads.

Turn on the gas supply. Check all gas connections for leaks using a soap solution.

If bubbles appear, tighten the connections and recheck.

DO NOT use an open flame to check for gas leaks.

### 3-WIRE system connections

1. Loosen or remove the center terminal block screw.
2. Connect the neutral wire (white or center wire) of the power cord to the center, silver-colored terminal screw of the terminal block. Tighten screw.
3. Connect the other wires to outer terminal block screws. Tighten screws.
4. Tighten the strain relief screws.
5. Insert the tab of the terminal block cover into your dryer's rear panel slot.

Secure the cover with a hold-down screw.

1. External ground connector
2. Neutral grounding wire (green/yellow)
3. Center silver-colored terminal block screw
4. Neutral wire (white or center wire)
5. 3/4" (1.9 cm) UL-listed strain relief

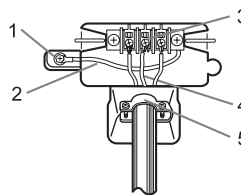

If converting from a 4-wire electrical system to a 3-wire, the ground strap must be reconnected to the terminal block support to ground the dryer frame to the neutral conductor.

#### 4-WIRE system connections

1. Remove the center terminal block screw.
  2. Connect the ground wire (green or unwrapped) of the power cord to the external ground conductor screw.
  3. Connect the neutral wire (white or center wire) of the power cord and the appliance ground wire (green with yellow stripes) under the central screw of the terminal block.
  4. Connect the other wires to the outer terminal block screws. Tighten screws.
  5. Tighten the strain relief screws.
  6. Insert the tab of the terminal block cover into your dryer's rear panel slot. Secure the cover with a hold-down screw.
    1. External ground connector
    2. Green or bare copper wire of power cord
    3. 3/4 in. (1.9 cm) UL-listed strain relief
    4. Center silver-colored terminal block screw
    5. Grounding wire (green/yellow)
    6. Neutral wire (white or center wire)
7. With a level, check your dryer and make necessary adjustments to the leveling legs.
  8. At this time, make sure all gas connections (on gas models), exhaust and electrical connections are complete. Plug in your dryer, and check operation by using the checklist below.
  9. (GAS MODELS ONLY- DV331AG\*)  
The burner may not ignite initially due to air in the gas line. Allowing your dryer to operate on a heat setting will purge the line. If the gas does not ignite within 5 minutes, turn your dryer off and wait 5 minutes. Be sure the gas supply to your dryer has been turned on. In order to confirm gas ignition, check the exhaust for heat.

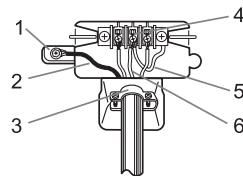

#### FINAL INSTALLATION CHECKLIST

- Dryer is plugged into an electrical outlet and is properly grounded.
- Exhaust ductwork is hooked up and joints are taped.
- Plastic flexible duct is NOT used.
- Used rigid or stiff-walled flexible metal vent material.
- Dryer is leveled and is sitting firmly on the floor.
- Gas models – gas is turned on with no gas leaks.
- Start your dryer to confirm that it runs, heats, and shuts off.

# installing your dryer

## DRYER EXHAUST TIPS



Plastic or non-metal flexible duct presents a potential fire hazard.

1. Make sure your dryer is installed properly so it exhausts air easily.

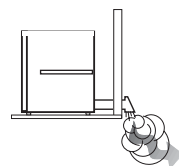

2. Use a 4" diameter rigid metal duct. Tape all joints, including at the dryer. Never use lint-trapping screws.

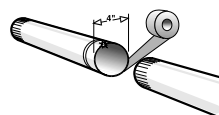

3. Keep ducts as straight as possible.

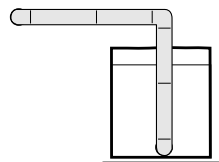

4. Clean all old ducts before installing your new dryer. Be sure the vent flap opens and closes freely. Inspect and clean the exhaust system annually.

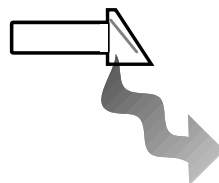

Don't let a poor exhaust system slow drying by:

1. Restricting your dryer with a poor exhaust system.
2. Using a plastic, thin foil, or non-metal flexible duct.
3. Unnecessarily using long ducts that have many elbows.
4. Having crushed or clogged ducts and vent.

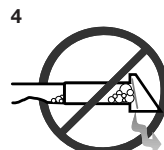
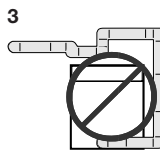
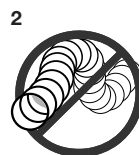

## DOOR REVERSAL

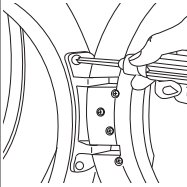
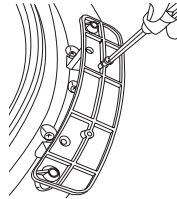
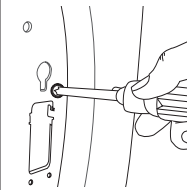
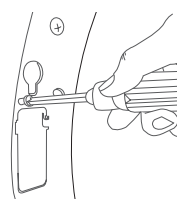
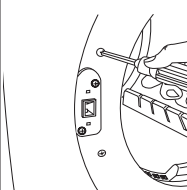
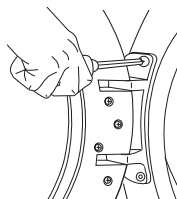
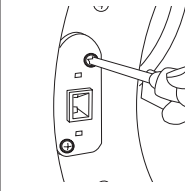
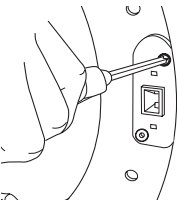
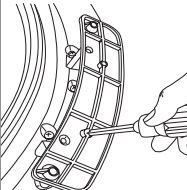
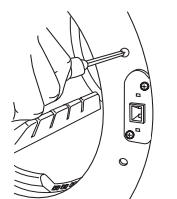
<ol style="list-style-type: none"> <li>1. Unplug the power cord.</li> <li>2. Remove two door hinge screws.</li> <li>3. Lift the door and remove it.</li> </ol>		<ol style="list-style-type: none"> <li>8. Reinsert the screw in the other hole.</li> </ol>	
<ol style="list-style-type: none"> <li>4. Remove a screw on the Frame Front</li> </ol>		<ol style="list-style-type: none"> <li>9. Reinsert the screw (Step 4) on the Frame Front</li> </ol>	
<ol style="list-style-type: none"> <li>5. Remove the two screws on the opposite side of the door hinge.</li> </ol>		<ol style="list-style-type: none"> <li>10. Place the door on the other side and reattach it to the dryer.</li> </ol>	
<ol style="list-style-type: none"> <li>6. Remove two screws from the holder lever.</li> </ol>		<ol style="list-style-type: none"> <li>11. Reattach the holder lever.</li> </ol>	
<ol style="list-style-type: none"> <li>7. Remove a screw from the door hinge.</li> </ol>		<ol style="list-style-type: none"> <li>12. Reattach the screws in the remaining holes.</li> </ol>	



The screw mentioned in STEP 4 may not exist.

# operating Instructions, tips

## OVERVIEW OF THE CONTROL PANEL

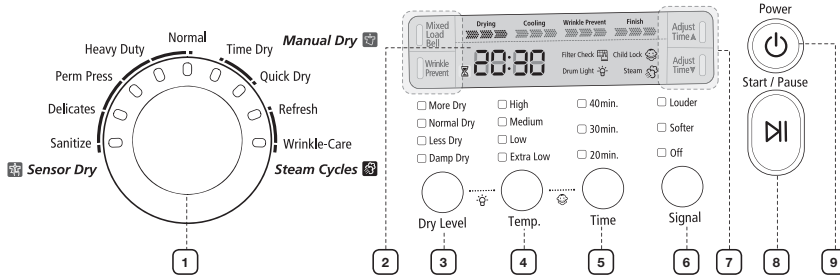

### 1 Cycle Selector

To select a cycle, rotate the Cycle Selector dial to the desired cycle. The indicator light by the cycle name will illuminate. The Normal, Heavy Duty, Towels, Perm Press, Delicates and Sanitize cycles are Sensor Dry cycles. Sensor Dry automatically senses the moisture in the load and shuts the dryer off when the selected dryness level (more dry to damp dry) is reached.

**Normal** – Use this cycle to dry loads such as cotton, underwear, and linen.

**Heavy Duty** – Use this cycle to get high heat for heavy fabrics such as jeans, corduroys, or work clothes.

**Perm Press** – Dry wrinkle-free cottons, synthetic fabrics, knits, and permanent press fabrics automatically. The cycle minimizes wrinkling by providing a longer unheated cool-down period at the end of the cycle.

**Delicates** – The Delicates cycle is designed to dry heat-sensitive items at a low drying temperature.

**Sanitize** - This course allows you to sanitize garments by permeating high temperature heat deep into the fabric during the drying cycle. Use this course to keep your bedding and curtains clean through sanitization.

**Time Dry** – Time Dry allows you to select the desired cycle time in minutes.

Turn the Cycle Selector dial to Time Dry, then press the Adjust Time up arrow to set the drying time.

Press the arrow repeatedly to scroll through the time settings.

**Quick Dry** - Provides a 30 minute drying cycle.

**Refresh** – This cycle is best for smoothing out wrinkles and reducing odors from loads consisting of one to four dry items. In this cycle a small amount of water is sprayed into the dryer drum after several minutes of tumbling with heat.

**Wrinkle Care** – This cycle will release wrinkles from items that have been left in the dryer too long. In this cycle a small amount of water is sprayed into the dryer drum after several minutes of tumbling with heat.

 Overloading the dryer may not yield the same results.



<p><b>2</b> <b>Digital Graphic Display</b></p>	<p>The display window shows the estimated time remaining in the cycle after the Start/Pause button is pressed. The estimated time remaining may fluctuate as the cycle progresses.</p> <p>The Drying light will illuminate and remain lit until the cycle is complete.</p> <p>When your dryer is in the cool-down phase, the Cooling light will illuminate.</p> <p>When your dryer is in the wrinkle prevent phase, the Wrinkle Prevent light will illuminate.</p> <p>When the cycle is complete, "END" appears in the display panel until the dryer door is opened, the Power, Close or Start button is pressed or about 5 minutes have passed.</p> <p>If your dryer is paused during a cycle, the indicator lights will blink until the Start/ Pause button is pressed.</p>
<p><b>3</b> <b>Dry Level Selection Button</b></p>	<p>To select the dry level in the Normal, Heavy Duty, or other Sensor Dry cycles, press the Dry Level button. An indicator light will illuminate next to the desired dryness level.</p> <p>Press the button repeatedly to scroll through the settings. Larger or bulkier loads may require the More Dry setting for complete dryness.</p> <p>The Less Dry setting is best suited for lightweight fabrics or for leaving some moisture in the clothing at the end of the cycle. Damp Dry is designed to partially dry items. Use for items that lay flat or hang to dry.</p>
<p><b>4</b> <b>Temp Selection Button</b></p>	<p>To select the correct temperature for the load, press the Temp button. An indicator light will illuminate next to the desired temperature. Press the button repeatedly to scroll through the settings.</p> <p><b>High</b> – For sturdy cottons or those labeled Tumble Dry.</p> <p><b>Medium</b> – For permanent press, synthetics, lightweight cottons, or items labeled Tumble Dry Medium.</p> <p><b>Low</b> – For heat sensitive items labeled Tumble Dry Low or Tumble Dry Warm.</p> <p><b>Extra Low</b> – Provides the lowest heated dry temperature possible.</p>
<p><b>5</b> <b>Time Selection Button</b></p>	<p>When using Manual Dry cycles, time can be adjusted by pressing the Time Selection button.</p> <p>During the Sensory Dry cycle, the time light indicator is off because exact drying times are determined by fluctuating humidity levels.</p>
<p><b>6</b> <b>Signal Selection Button</b></p>	<p>When the cycle is complete, a chime will sound.</p> <p>When the Wrinkle Prevent option is selected, the chime will sound intermittently. Adjust the volume of the chime or turn it off by pressing the Signal button.</p> <p>Press the button repeatedly to scroll through the choices.</p>

# operating Instructions, tips

<b>7</b> <b>Select Cycle Option</b>	<p><b>Mixed Load Bell</b> - This is an alarm that notifies the user when the average dry level is damp dry (80% dried). This is useful when the laundry contains various types of clothing you do not want to dry completely. An alarm sounds for five (5) seconds while continuing to perform the cycle.</p> <p>This function can only be selected in the Sensor Dry course, and the dry level can only be selected from among Normal Dry, More Dry.</p> <p><b>Wrinkle Prevent</b> -Wrinkle Prevent provides approximately 90 minutes of intermittent tumbling in unheated air at the end of the cycle to reduce wrinkling. Press the Wrinkle Prevent button to activate this feature.</p> <p>The indicator light above the pad will illuminate when Wrinkle Prevent is selected. The load is dry, and can be removed at any time during the Wrinkle Prevent cycle.</p> <p><b>Adjust Time</b> – Time can be added or subtracted from the automatically set times in the Manual Dry cycles (Time Dry, Quick Dry, Wrinkle Release cycles).</p> <p>To add or subtract time from the cycle, press the Adjust Time arrow pad up or down until the desired time is displayed.</p>
<b>8</b> <b>Start/Pause selection button</b>	Press to pause and restart programs.
<b>9</b> <b>Power button</b>	Press once to turn your dryer on, press again to turn it off. If your dryer is left on for more than 10 minutes without any buttons being touched, the power automatically turns off.

## CHILD LOCK

---

A function to prevent children from playing with your dryer.

### Setting/Releasing

---

If you want to set or release the Child Lock, press both the Temp. and Time buttons simultaneously for 3 seconds.

#### How to Set:

1. It can be set while your dryer is running.
2. Once you set the Child Lock function, no button, except for the Power button, will respond until you release the Child Lock function.
3. The Child Lock indicator will be lit.



1. If the dryer is powered on again, the Child Lock function stays on.
2. To release that function, follow the instructions above.



- When other buttons, except for the Power button, do not respond, check the Child Lock indicator.

## DRUM LIGHT

---

Lights the dryer drum while the dryer is running.

### Setting & releasing

---

If you want to set or release the Drum Light, press both the Dry Level and Temp. buttons simultaneously.



- It can be set while your dryer is not only running but also when it is stopped.
- If you do not turn the Drum Light off within 4 minutes of turning it on, it is automatically turned off.

## CHANGING THE LANGUAGE

---

You may change the language shown in the display from English to French or Spanish.

Press and hold the Rack Dry and Wrinkle Prevent buttons for 3 seconds until the display changes. Then select the desired language by pressing the Signal button.

Once set, the selected language will remain in memory, even if the dryer is turned off or unplugged.

# operating Instructions, tips

## RACK DRY(OPTIONAL)

### Installing the drying rack

1. Open the dryer door.
2. Position the drying rack in the tumbler, placing the front lip of the drying rack on the top of the lint filter.
3. Place the rear legs in the two recessed areas of the dryer's back wall, then push down the middle of the drying rack to fix.
4. Place the items to be dried on the rack, leaving space between them so air can circulate.
5. Close the dryer door.
6. Use only the Time Dry(Temp selection - Extra Low) cycle. Select the time according to the moisture and weight of the items. Start the dryer. It may be necessary to reset the timer if a longer drying time is needed.

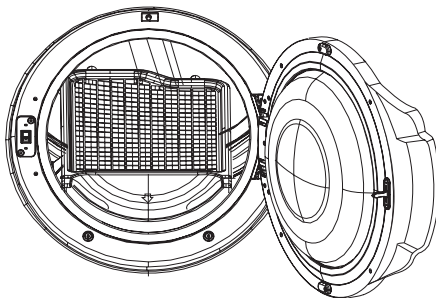

SUGGESTED ITEMS	SUGGESTED TEMP. SETTINGS
Washable sweaters (block to shape and lay flat on rack)	Heat (Extra Low)
Stuffed toys (cotton or polyester fiberfilled)	Heat (Extra Low)

 **WARNING** Drying foam rubber, plastic, or rubber on a heat setting may cause damage to the items and lead to a fire hazard.

 Drying Rack is not supplied in this model. The Drying Rack is optional. You can purchase it through a service center. (Part code :DC61-01522A)

## CLEAN THE LINT FILTER

---

- After each load.
- To shorten drying time.
- To operate more energy efficiently.



Do not operate your dryer without the lint filter in place.

## LOAD THE DRYER PROPERLY

---

- Place only one washload in your dryer at a time.
- Mixed loads of heavy and lightweight fabrics will dry differently, which may result in lightweight fabrics being dry while heavy fabrics remain damp at the end of a drying cycle.
- Add one or more similar items to your dryer when only one or two articles of clothing need drying. This improves the tumbling action and drying efficiency.
- Overloading restricts tumbling action, resulting in uneven drying as well as excessive wrinkling of some fabrics.

## GETTING STARTED

---

1. Load your dryer loosely – DO NOT overload.
2. Close the door.
3. Select the appropriate cycle and options for the load (see pages 20, 21).
4. Press the Start/Pause button.
5. The dryer indicator light will illuminate.
6. The estimated cycle time will appear in the display.  
The time may fluctuate to better indicate drying time remaining in the cycle.



- When the cycle is complete, the Door Lock light will go out and “End” will appear in the display.
- Pressing Power cancels the cycle and stops your dryer.
- The Drying, Cooling, and Wrinkle Prevent indicator lights will illuminate during those portions of the cycle.



Do not place anything on top of your dryer while it is running.

# care and cleaning

---

## **CONTROL PANEL**

---

Clean with a soft, damp cloth. Do not use abrasive substances.

Do not spray cleaners directly on the panel.

The control panel finish may be damaged by some laundry pre-treatment soil and stain remover products.

Apply such products away from your dryer and wipe up any spills or overspray immediately.

## **TUMBLER**

---

Remove any stains such as crayon, ink, or fabric dye (from new items such as towels or jeans) with an all-purpose cleaner.

Tumble old towels or rags to remove any excess stain or cleaning substance.

Once these steps are followed, stains may still be visible, but should not transfer to subsequent loads.

## **STAINLESS STEEL TUMBLER**

---

To clean the stainless steel tumbler, use a damp cloth with a mild, non-abrasive cleaner suitable for stainless steel surfaces.

Remove the cleaner residue and dry with a clean cloth.

## **DRYER EXTERIOR**

---

The entire dryer has a high-gloss finish. Clean with a soft, damp cloth. Do not use abrasive substances.

Protect the surface from sharp objects as they may scratch or damage the finish.

Do not place any heavy or sharp objects or a detergent box on the dryer. Keep them on the purchased pedestal or in a separate storage box.

## **DRYER EXHAUST SYSTEM**

---

Should be inspected and cleaned yearly to maintain optimum performance.

The outside exhaust hood should be cleaned more frequently to ensure proper operation.

# special laundry tips

## SPECIAL LAUNDRY TIPS

Please follow the care label or manufacturer's instructions for drying special items. If care label instructions are not available, use the following information as a guide.

<b>Bedspreads &amp; Comforters</b>	<ul style="list-style-type: none"><li>• Follow the care label instructions or dry on the Normal cycle and High temperature.</li><li>• Make sure the item is thoroughly dry before using or storing.</li><li>• May require repositioning to ensure even drying.</li></ul>
<b>Blankets</b>	<ul style="list-style-type: none"><li>• Use Normal cycle and dry only one blanket at a time for best tumbling action.</li><li>• Make sure the item is thoroughly dry before using or storing.</li></ul>
<b>Curtains &amp; Draperies</b>	<ul style="list-style-type: none"><li>• Use the Perm Press cycle and Low or Extra Low temperature to help minimize wrinkling.</li><li>• Dry in small loads for best results and remove as soon as possible.</li></ul>
<b>Cloth Diapers</b>	<ul style="list-style-type: none"><li>• Use the Normal cycle and the High temperature settings for soft, fluffy diapers.</li></ul>
<b>Down-filled Items (jackets, sleeping bags, comforters, etc.)</b>	<ul style="list-style-type: none"><li>• Use the Normal cycle and the Low or Extra Low temperature setting.</li><li>• Adding a couple of dry towels shortens drying time and absorbs moisture.</li></ul>
<b>Pillows</b>	<ul style="list-style-type: none"><li>• Use the Normal cycle.</li><li>• Add a couple of dry towels to help the tumbling action and to fluff the item.</li><li>• DO NOT dry kapok or foam pillows in dryer.</li></ul>
<b>Plastics (shower curtains, outdoor furniture covers, etc.)</b>	<ul style="list-style-type: none"><li>• Use the Time Dry cycle and the Low or Extra Low temperature settings depending on the care label instructions.</li></ul>

### THINGS TO AVOID :

- Fiberglass items (curtains, draperies, etc.).
- Woolens, unless recommended on the label.
- Vegetable or cooking oil-soaked items.
- Foam Rubber (rug backs, stuffed toys, shoulder pads, etc.)

# troubleshooting

## CHECK THESE POINTS IF YOUR DRYER...

PROBLEM	SOLUTION
Doesn't run.	<ul style="list-style-type: none"><li>• Make sure the door is latched shut.</li><li>• Be sure the power cord is plugged into a live electrical outlet.</li><li>• Check the home's circuit breaker and fuses.</li><li>• Press the Start/Pause button again if the door is opened during the cycle.</li></ul>
Doesn't heat.	<ul style="list-style-type: none"><li>• Check the home's circuit breaker and fuses.</li><li>• On a gas dryer, check that the gas supply is on.</li><li>• Clean the lint filter and exhaust duct.</li><li>• Dryer may have moved into the cool-down phase of the cycle.</li></ul>
Doesn't dry.	<ul style="list-style-type: none"><li>• Check all of the above, plus...</li><li>• Be sure the exhaust hood outside the home can open and close freely.</li><li>• Check exhaust system for lint buildup. Ducting should be inspected and cleaned annually.</li><li>• Use a 4" rigid metal exhaust duct.</li><li>• Do not overload. 1 wash load = 1 dryer load.</li><li>• Sort heavy items from lightweight items.</li><li>• Large, bulky items like blankets or comforters may require repositioning to ensure even drying.</li><li>• Check that the washer is draining properly to extract adequate water from the load.</li><li>• Load may be too small to tumble properly. Add a few towels.</li></ul>
Is noisy.	<ul style="list-style-type: none"><li>• Check the load for objects such as coins, loose buttons, nails, etc. Remove promptly.</li><li>• It is normal to hear the dryer gas valve or heating element cycle on and off during the drying cycle.</li><li>• Be sure the dryer is leveled properly as outlined in the installation instruction.</li><li>• It is normal for the dryer to hum due to the high velocity of air moving through the dryer drum and exhaust system.</li></ul>
Dries unevenly.	<ul style="list-style-type: none"><li>• Seams, pockets, and other similarly heavy areas may not be completely dry when the rest of the load has reached the selected dryness level. This is normal. Select the More Dry setting if desired.</li><li>• If one heavy item is dried with a lightweight load, such as one towel with sheets, it is possible that the heavy item will not be completely dry when the rest of the load has reached the selected dryness level. Sort heavy items from lightweight items for best drying results.</li></ul>
Has an odor.	<ul style="list-style-type: none"><li>• Household odors from painting, varnishing, strong cleaners, etc. may enter the dryer with the surrounding room air. This is normal as the dryer draws the air from the room, heats it, pulls it through the tumbler, and exhausts it outside.</li><li>• When these odors linger in the air, ventilate the room completely before using the dryer.</li></ul>



<b>PROBLEM</b>	<b>SOLUTION</b>
<b>Shuts off before load is dry</b>	<ul style="list-style-type: none"> <li>• Dryer load is too small. Add more items or a few towels and restart the cycle.</li> <li>• Dryer load is too large. Remove some items and restart the dryer.</li> </ul>
<b>Lint on clothes</b>	<ul style="list-style-type: none"> <li>• Make sure the lint filter is cleaned before every load. With some loads that produce high amounts of lint, it may be necessary to clean the filter during the cycle.</li> <li>• Some fabrics are lint producers (for example, a fuzzy white cotton towel) and they should be dried separately from clothes that are lint trappers (for example, a pair of black linen pants)</li> <li>• Divide larger loads into smaller loads for drying</li> <li>• Check pockets thoroughly before washing and drying clothes.</li> </ul>
<b>Garments still wrinkled after Wrinkle-Care</b>	<ul style="list-style-type: none"> <li>• Small loads of 1 to 4 items work best.</li> <li>• Load fewer garments. Load similar-type garments.</li> </ul>
<b>Odors remain in clothing after Refresh.</b>	<ul style="list-style-type: none"> <li>• Fabrics containing strong odors should be washed in a normal cycle.</li> </ul>
<b>Water drips from nozzle when Steam-Care starts</b>	<ul style="list-style-type: none"> <li>• This is steam condensation. The dripping water will stop after a short time.</li> </ul>
<b>Sprayed water is not visible during Steam-Care</b>	<ul style="list-style-type: none"> <li>• Sprayed water is difficult to see when the door is closed</li> </ul>

# troubleshooting

## INFORMATION CODES

Information codes may be displayed to help you better understand what is occurring with your Dryer.



































ERROR DISPLAY	MEANING	SOLUTION
<b>tS</b>	Clogged Lint Screen	Clean the screen or vent.
<b>tO</b>	Vent is restricted	If the problem continues call for service.
<b>dO</b> <b>dE</b>	Running the dryer with door open	Close the door and then restart. If the problem continues call for service.
<b>dF</b>	Door is not closing properly	Call for service.
<b>bE</b> <b>bE2</b>	Unit detects a button is being pressed for over 30secs or button is stuck	Make sure a button is NOT being pressed continuously. Try restarting the cycle. If the problem continues call for service.
<b>od</b>	Invalid Dry time	Call for service.
<b>hE</b>	Invalid heating Temp	Call for service.
<b>Et</b>	EEPROM is not communicating properly	Try restarting the cycle. If the problem continues call for service.
<b>FE</b>	Invalid power source Frequency	Try restarting the cycle. If the problem continues call for service.

For any codes not listed above, call 1-800-SAMSUNG(726-7864).

# appendix

## FABRIC CARE CHART

The following symbols provide garment care direction. The Clothing care labels include symbols for washing, bleaching, drying and ironing, or dry cleaning when necessary. The use of symbols ensures consistency among garment manufacturers of domestic and imported items. Follow care label directions to maximize garment life and reduce laundering problems.

Wash Cycle		Special Instructions		Warning Symbols for Laundering	
	Normal		Line Dry/ Hang to Dry		Do Not Wash
	Permanent Press / Wrinkle Resistant / Wrinkle Control		Drip Dry		Do Not Wring
	Gentle/Delicates		Dry Flat		Do Not Bleach
	Hand Wash	<b>Heat Setting</b>			Do Not Tumble Dry
<b>Water Temperature**</b>			High		No Steam (added to iron)
	Hot		Medium		Do Not Iron
	Warm		Low	<b>Dryclean</b>	
	Cold		Any Heat		Dry Clean
<b>Bleach</b>			No Heat/Air		Do Not Dry Clean
	Any Bleach (when needed)	<b>Iron-Dry or Steam Temperatures</b>			Line Dry/ Hang to Dry
	Only Non-Chlorine (color-safe) Bleach (when needed)		High		Drip Dry
	Tumble Dry Cycle		Medium		Dry Flat
<b>Normal</b>			Low		
	Permanent Press/ Wrinkle Resistant/ Wrinkle Control				
	Gentle/ Delicates				

\*\* The dot symbols represent appropriate wash water temperatures for various items. The temperature range for Hot is 105° – 125° F/ 41° – 52° C, for Warm 85° – 105° F/29° – 41° C and for Cold 60° – 85° F/16° – 29° C. (Wash water temperature must be a minimum of 60° F/16° C for detergent activation and effective cleaning.)

# appendix

## PROTECTING THE ENVIRONMENT

This appliance is manufactured from recyclable materials. If you decide to dispose of this appliance, please observe local waste disposal regulations. Cut off the power cord so that the appliance cannot be connected to a power source. Remove the door so that animals and small children cannot get trapped inside the appliance.

## DECLARATION OF CONFORMITY

This appliance complies with UL2158.

## SPECIFICATIONS

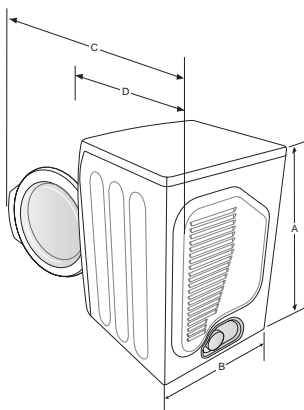

TYPE	FRONT LOADING DRYER			
DIMENSIONS	Div	Inches (cm)	Div	Inches (cm)
	A. Height	38.6" (98.1)	C. Depth with door open 90°	49" (124.5)
	B. Width	27" (68.6)	D. Depth	30.9" (78.3)
WEIGHT	121.3lb (55kg)			
HEATER RATING	5300 W			
POWER CONSUMPTION	NO HEAT		268 W	
	HEATING		5445 W	

## CYCLE CHART

Cycle		Default			Drying	Cooling	Wrinkle prevent
		Temp control	Sensor dry level	Time	Time	Time	Time
Sensor Dry	Normal	High (Medium)	Normal dry	42 min	39 min	3 min	90 min
	Heavy Duty	High (No change)	Normal dry	58 min	55 min	3 min	
	Perm Press	Medium (No change)	Normal dry	32 min	29 min	3 min	
	Delicates	Low (No change)	Normal dry	27 min	24 min	3 min	
	Sanitize	High (No change)	More dry	60 min	55 min	5 min	
Manual Dry	Time Dry	High	-	40 min	37 min	3 min	
	Quick Dry	High (No change)	-	30 min	27 min	3 min	
Steam Cycles	Refresh	High (No change)	-	15 min	14 min	1 min	
	Wrinkle-Care	High (No change)	-	20 min	19 min	1 min	

# warranty

---

## **SAMSUNG DRYER**

### **LIMITED WARRANTY TO ORIGINAL PURCHASER**

This SAMSUNG brand product, as supplied and distributed by SAMSUNG ELECTRONICS AMERICA, INC. (SAMSUNG) and delivered new, in the original carton to the original consumer purchaser, is warranted by SAMSUNG against manufacturing defects in materials and workmanship for a limited warranty period of:

- One (1) Year All Parts and Labor
- Two (2) Years Control Board Parts

This limited warranty begins on the original date of purchase, and is valid only on products purchased and used in the United States.

To receive warranty service, the purchaser must contact SAMSUNG for problem determination and service procedures.

Warranty service can only be performed by a SAMSUNG authorized service center.

The original dated bill of sale must be presented upon request as proof of purchase to SAMSUNG or SAMSUNG's authorized service center.

SAMSUNG will provide in-home service during the warranty period at no charge, subject to availability within the contiguous United States.

In-home service is not available in all areas.

To receive in-home service, product must be unobstructed and accessible to the service agent.

If service is not available, SAMSUNG may elect to provide transportation of the product to and from an authorized service center.

SAMSUNG will repair, replace, or refund this product at our option and at no charge as stipulated herein, with new or reconditioned parts or products if found to be defective during the limited warranty period specified above.

All replaced parts and products become the property of SAMSUNG and must be returned to SAMSUNG. Replacement parts and products assume the remaining original warranty, or ninety (90) days, whichever is longer.

This limited warranty covers manufacturing defects in materials and workmanship encountered in normal, noncommercial use of this product and shall not apply to the following: damage that occurs in shipment; delivery and installation; applications and uses for which this product was not intended; altered product or serial numbers; cosmetic damage or exterior finish; accidents, abuse, neglect, fire, water, lightning, or other acts of nature or God; use of products, equipment, systems, utilities, services, parts, supplies, accessories, applications, installations, repairs, external wiring or connectors not supplied or authorized by SAMSUNG that damage this product or result in service problems; incorrect electrical line voltage, fluctuations and surges; customer adjustments and failure to follow operating instructions, maintenance and environmental instructions that are covered and prescribed in the instruction book; product removal and reinstallation; problems caused by pest infestations.

This limited warranty does not cover problems resulting from incorrect electric current, voltage or supply, light bulbs, house fuses, house wiring, cost of a service call for instructions, or fixing installation errors.

SAMSUNG does not warrant uninterrupted or error-free operation of the product.

EXCEPT AS SET FORTH HEREIN, THERE ARE NO WARRANTIES ON THIS PRODUCT EITHER EXPRESS OR IMPLIED, AND SAMSUNG DISCLAIMS ALL WARRANTIES INCLUDING, BUT NOT LIMITED TO, ANY IMPLIED WARRANTIES OF MERCHANTABILITY, INFRINGEMENT OR FITNESS FOR A PARTICULAR PURPOSE.

NO WARRANTY OR GUARANTEE GIVEN BY ANY PERSON, FIRM, OR CORPORATION WITH RESPECT TO THIS PRODUCT SHALL BE BINDING ON SAMSUNG.

SAMSUNG SHALL NOT BE LIABLE FOR LOSS OF REVENUE OR PROFITS, FAILURE TO REALIZE SAVINGS OR OTHER BENEFITS, OR ANY OTHER SPECIAL, INCIDENTAL OR CONSEQUENTIAL DAMAGES CAUSED BY THE USE, MISUSE, OR INABILITY TO USE THIS PRODUCT, REGARDLESS OF THE LEGAL THEORY ON WHICH THE CLAIM IS BASED, AND EVEN IF SAMSUNG HAS BEEN ADVISED OF THE POSSIBILITY OF SUCH DAMAGES.

NOR SHALL RECOVERY OF ANY KIND AGAINST SAMSUNG BE GREATER IN AMOUNT THAN THE PURCHASE PRICE OF THE PRODUCT SOLD BY SAMSUNG AND CAUSING THE ALLEGED DAMAGE.

WITHOUT LIMITING THE FOREGOING, PURCHASER ASSUMES ALL RISK AND LIABILITY FOR LOSS, DAMAGE, OR INJURY TO PURCHASER AND PURCHASER'S PROPERTY AND TO OTHERS AND THEIR PROPERTY ARISING OUT OF THE USE, MISUSE, OR INABILITY TO USE THIS PRODUCT. THIS LIMITED WARRANTY SHALL NOT EXTEND TO ANYONE OTHER THAN THE ORIGINAL PURCHASER OF THIS PRODUCT, IS NONTRANSFERABLE AND STATES YOUR EXCLUSIVE REMEDY.

Some states do not allow limitations on how long an implied warranty lasts, or the exclusion or limitation of incidental or consequential damages, so the above limitations or exclusions may not apply to you. This warranty gives you specific rights, and you may also have other rights, which vary from state to state.

**To obtain warranty service, please contact SAMSUNG at:  
SAMSUNG ELECTRONICS AMERICA, INC.  
85 CHALLENGER ROAD RIDGEFIELD PARK, NJ 07660  
1-800-SAMSUNG (726-7864)  
[www.samsung.com](http://www.samsung.com)**



QUESTIONS OR COMMENTS?

Country	CALL	OR VISIT US ONLINE AT
U.S.A	1-800-SAMSUNG(726-7864)	<a href="http://www.samsung.com">www.samsung.com</a>
MEXICO	01-800-SAMSUNG(726-7864)	<a href="http://www.samsung.com">www.samsung.com</a>

Code No. DC68-03026A-01\_EN