

# Danby Premiere®

## Owner's Use and Care Guide Guide d'utilisation et soins de Propriétaire

Model • Modèle  
**DPAC13012H**

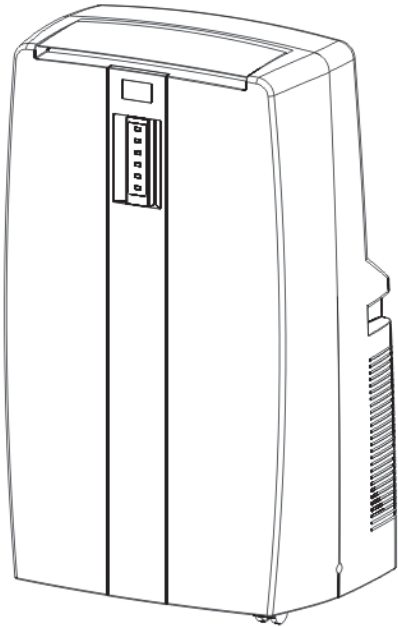

**CAUTION:** Read and follow all safety rules and operating instructions before first use of this product.

**MISE EN GARDE:** Veuillez lire attentivement les consignes de sécurité et les directives d'utilisation avant l'utilisation initiale de ce produit.

### PORTABLE AIR CONDITIONER

**Owner's Use and Care Guide** ..... 1 - 12

- Welcome
- Part Identification
- Important Safety Information
- Installation
- Operation
- Care and Maintenance
- Troubleshooting
- Warranty

### CLIMATISEUR PORTATIF

**Guide d'utilisation et soin de Propriétaire** ..... 13 - 24

- Bienvenue
- Identification de Partie
- Consignes de Sécurité Important
- Installation
- Fonctionnement
- Soins et Entretien
- Garantie

**KEEP THESE INSTRUCTIONS FOR FUTURE REFERENCE:  
If the unit changes ownership, be sure this manual accompanies the unit.  
CONSERVER CES INSTRUCTIONS POUR CONSULTATION ULTÉRIEURE:  
En cas de revente du l'appareil, ce manuel doit être inclus avec l'appareil.**

Danby Products Ltd, Guelph, Ontario Canada N1H 6Z9  
Danby Products Inc, Findlay, Ohio USA 45840

---

## WELCOME

---

Thank you for choosing a Danby Premiere appliance to provide you and your family with all of the “Home Comfort” requirements of your home, cottage, or office. This Owner’s Use and Care Guide will provide you with valuable information necessary for the proper care and maintenance of your new appliance. If properly maintained, your Danby appliance will give you many years of trouble free operation. Please take a few moments to read the instructions thoroughly and familiarize yourself with all of the operational aspects of this appliance.

Your Danby Portable Air-Conditioner is a multi-functional room air-exchanging, air-processing appliance, designed to offer you the functions of; Air Conditioning, Dehumidifying, and Independent Fan. Each individual mode is featured with “oscillating” air swing capabilities. This unit can be conveniently moved from room to room within your home and set up in just minutes. Imagine the convenience of 4 Season Home Comfort at your fingertips, anywhere, anytime.

For easy reference, may we suggest you attach a copy of your sales slip/receipt to this page, along with the following information, located on the manufacturers nameplate on the rear panel of the unit.

Model Number: \_\_\_\_\_

Serial Number: \_\_\_\_\_

Date of Purchase: \_\_\_\_\_

This information will be necessary if your unit requires servicing and/or for general inquiries. To contact a Customer Service Representative, call Danby TOLL FREE: 1-800-26-**Danby** (1-800-263-2629)

## PART IDENTIFICATION

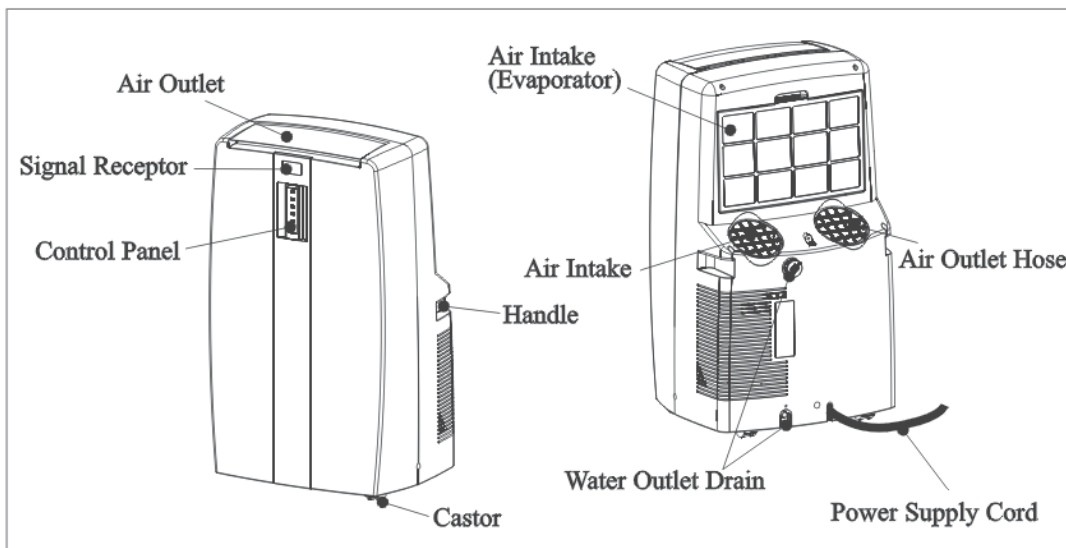

## IMPORTANT SAFETY INFORMATION

**READ ALL SAFETY INFORMATION BEFORE USING**

### ELECTRICAL SPECIFICATIONS

- 1) Check available power supply and resolve any wiring problems **BEFORE** installation and operation of this unit. All wiring must comply with local and national electrical codes and be installed by a qualified electrician. If you have any questions regarding the following instructions, contact a qualified electrician.
- 2) This appliance draws 10.8/12 nameplate amps under Cooling/Heating Mode and may be used in any properly wired, general purpose 15 amp household grounded receptacle.
- 3) For your safety and protection, this unit is grounded through the power cord plug when plugged into a matching wall outlet. If you are not sure whether the wall outlets in your home are properly grounded, please consult a qualified electrician.

**WARNING:** Improper connection of the grounding plug can result in risk of Fire, Electric Shock, and/or injury to Persons associated with the appliance. Check with a qualified service representative if in doubt that the appliance is properly grounded.

- 4) **DO NOT USE PLUG ADAPTERS OR EXTENSION CORDS WITH THIS UNIT.** If it is necessary to use an extension cord with this unit, use an approved "air conditioner" extension cord only (available at most local hardware stores).
- 5) To avoid the possibility of personal injury, always disconnect the power supply to the unit before installing and/or servicing.

**TABLE 1**

Suggested Individual Branch Circuit	
Nameplate Amps 10.8(Cooling)/12(Heating)	*AWG Wire Size 16
AWG- American Wire Gauge *Based on copper wire at 105°C temperature rating.	

**TABLE 2**

Receptacle and Fuse Types	
Rated Volts	125
Amps	15
Wall Outlet	
Fuse Size	15
Time Delay Fuse (or Circuit Breaker)	Plug Type

**CAUTION:** Do not leave this unit unattended in a space where people or animals that cannot react to a failed unit are located. A failed unit can cause extreme overheating or death in such an enclosed, unattended space.

---

## IMPORTANT SAFETY INFORMATION

---

### POWER SUPPLY CORD

The power cord supplied with this air conditioner contains a device that senses damage to the power cord. To test if your power cord is working properly, you must do the following:

- 1) Connect the power supply cord to an electrical outlet.
- 2) The power supply cord has two buttons located on the head of the plug. One button is marked "TEST", and the other is marked "RESET". Press the "TEST" button; you will hear a click as the "RESET" button pops out.
- 3) Press the "RESET" button; you will hear a click as the button engages.
- 4) The power supply cord is now energized and supplying electricity to the air conditioner (on some products this is also indicated by a light on the plug head).

**NOTE:** The power cord supplied with this air conditioner contains a current leakage detection device designed to reduce the risk of fire. In the event the power supply cord is damaged, it cannot be repaired and must be replaced with a new cord from the product manufacturer.

- Under no circumstances should this device be used to turn the unit on or off.
- The "RESET" button must always be pushed in (engaged) for correct operation.
- The power supply cord must be replaced if it fails to reset when the "TEST" button is pushed in.

---

### ENERGY-SAVING TIPS

Your Danby appliance is designed to be highly efficient in energy savings. Follow these recommendations for greater efficiency.

- 1) Select a thermostat setting that suits your comfort needs and leave at that chosen setting.
- 2) The air filter is very efficient in removing airborne particles. Keep the air filter clean at all times.
- 3) Use drapes, curtains or shades to keep direct sunlight from penetrating and heating room, but do not allow drapes or curtains to obstruct the air flow around the unit.
- 4) Start your air conditioner before the outdoor air becomes hot and uncomfortable, to avoid an initial period of discomfort while the unit is cooling off the room. Use of the automatic start/stop programmable TIMER feature can be a major asset in this regard if utilized to the fullest extent.
- 5) When outdoor temperatures are cool enough, turn the air conditioner off and use the FAN MODE on High, Medium or Low. This circulates indoor air, providing some cooling comfort while utilizing less electricity.

# INSTALLATION

## WARNING

**ELECTRIC SHOCK HAZARD:** To avoid the possibility of personal injury, disconnect power to the unit before installing or servicing.

## INSTALLATION ACCESSORIES (FIG. 1)

**Flexible Exhaust Hose** (ø13cm) & **Exhaust nozzle connector** (2 pcs)... from 21 <sup>13</sup>/<sub>20</sub>" (55cm) up to 66 <sup>3</sup>/<sub>20</sub>" (168cm)

**Adjustable window door slider kit** (3 pcs)..... from 28 <sup>1</sup>/<sub>3</sub>" (72cm) up to 80" (203cm)

**Fixture**..... (1pc)

**Screws**...(4 pcs)

**NOTE:** The exhaust/window kit must be installed at all times when the unit is operating under AIR CONDITIONING mode.

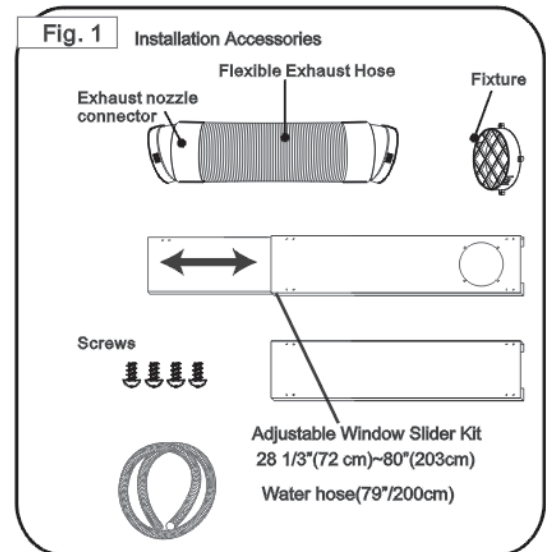

## IMPORTANT

There should be at least 11.8" (30cm) clearance between the unit and any other objects or building structures, and should be installed on a level surface. The unit does not have to be vented outside during Dehumidifying or Fan Only mode operation.

## INSTRUCTIONS FOR ASSEMBLING THE WINDOW ADAPTER KIT (FIG. 2).

- Insert tube adapters through the back of the window panel.
- Secure each tube adapter with four screws through the front of the window panel.
- Insert window panel extensions into the window panel. Lightly tighten the screws in the window panel to hold the extensions in place.

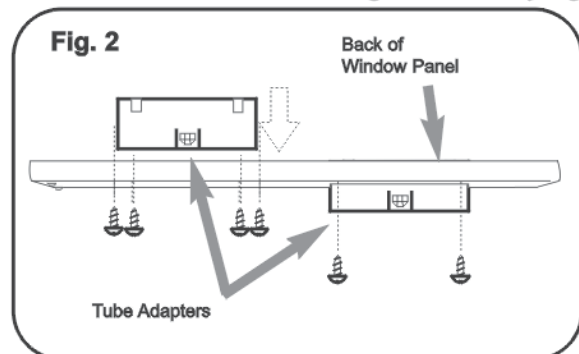

## WINDOW KIT INSTALLATION

Your window kit has been designed to fit most standard "vertical"/"horizontal" windows up to a maximum height of 80" (203cm). For vertical window applications, multi lock positions are provided on the edge of each slider section to secure each sliding section together.

- Select a suitable location, making sure you have access to an electrical outlet.
- Install the flexible hose to the rear side of the unit. Insert the hose collar on top of the exhaust opening and twist to lock into position.
- Install the adjustable Window Slider Kit as required (see Fig. 3a & 3b).
- Install the opposite end of the flexible exhaust hose into the window exhaust adapter.
- Install the window exhaust adapter into the opening in the slider section, making sure the window slider sections are secure.
- Plug the unit into a 115V/60Hz grounded electrical outlet.

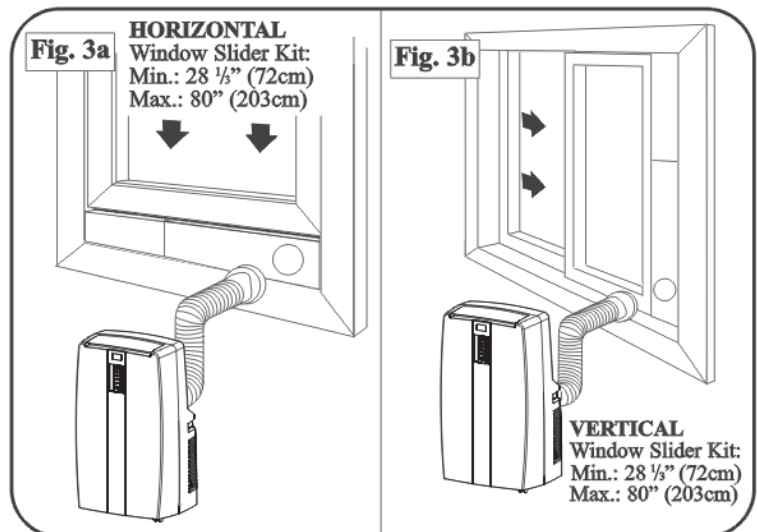

# OPERATION



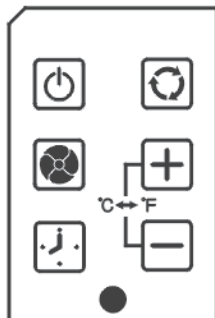

## FEATURES OF THE CONTROL PANEL

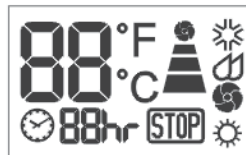

## LCD Display



### KEY PAD FUNCTIONS

-  **POWER SWITCH:** Turns unit ON/OFF
-  **MODE:** Allows you to scroll through and select desired operating mode.
-  **FAN:** Select from three different fan settings; *High, Medium, and Low.*
-  **AUTO-TIMER**

### AUTO-TIMER Adjust:

**AUTO TURN OFF-** With machine in **running mode**, press timer button to set timer control. Press " + " or " - " buttons to select number of hours you would like the unit to run before it automatically shuts off.

**AUTO TURN ON-** With machine in **stand by mode**, press timer button to set timer control. Press " + " or " - " buttons to select number of hours before the unit automatically starts running **under any one mode.**

**NOTE: The time is adjustable between 1-24 hours.**

### TEMPERATURE Adjust:







- Used for adjusting the thermostat.
- The default display is room temperature.
- In cooling mode, when " + " or " - " button is pressed, the set temperature is displayed and may be adjusted. After 15 seconds the display will revert back to room temperature. Temperature is only adjustable in cool mode.

**NOTE: By pressing both " + " / " - " buttons at the same time for more than 3 seconds, the display will toggle between Celsius and Fahrenheit.**

### Warning Light

Condensed water may accumulate in the unit. If the internal tank becomes full, the Warning signal in the LCD Display will light up and the unit will not operate until it has been drained.

### LCD Display

-  **Cooling Mode**
-  **Dehumidify Mode**
-  **Fan Only Mode**
-  **Heating mode**
-  **High Fan Speed**
-  **Medium Fan Speed**
-  **Low Fan Speed**

 **Display Set Temperature**

 **Display Timer Setting of Auto Switch ON / OFF**

 **Warning Light (the machine will stop running)**

**NOTE: After switching the air conditioner off, you must wait 3 minutes before switching it back on again.**

## OPERATION (cont'd)

### AIR CONDITIONING

**NOTE:** The exhaust hose must be properly vented outdoors during air conditioning mode.

- 1) Press the POWER SWITCH key (Fig. A) to switch on the unit, and the **previous set temperature** will be shown in the temperature display area of the control panel.
  - 2) Press the MODE key (Fig. B) until the COOL indicator light illuminates on the control panel (Fig.C). Each depression of the MODE key will advance to a different mode setting (Cool- Dehumidifier-Fan-Heat).
  - 3) Press the appropriate increase "+" or decrease "-" buttons (Fig. D1 & D2) to select a suitable operating temperature setting. Temperature settings are adjustable between 16°C (61°F) to 32°C (89°F).
  - 4) Press the FAN key (Fig. E) to select the desired fan speed setting (High-Med.-Low). Your selection will appear on the control panel (each depression of the fan key will advance to a different setting).
- Cooling stops automatically when the set temperature is achieved. Cooling resumes when the room temp. rises above the "set" temperature level.

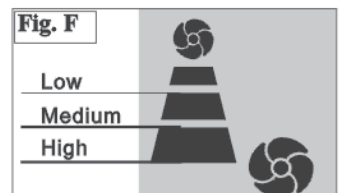
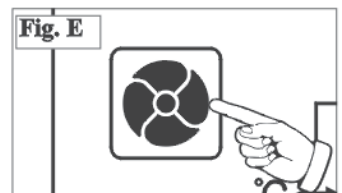
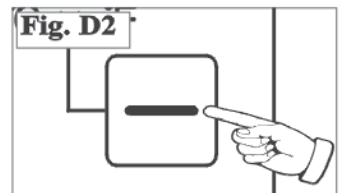
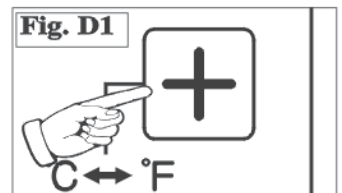
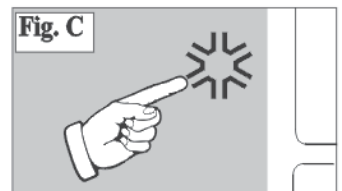
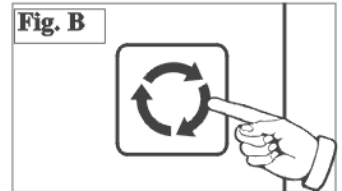
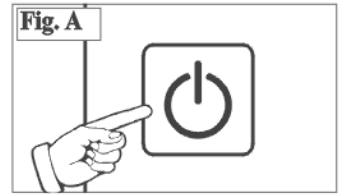

### DRAINING EXCESS WATER

- 1) Drain excess water from the tank by placing a pan under the drain water outlet (Fig.4)
- 2) Unscrew the drain cover and remove the soft rubber stopper, let the water drain into the pan. When the water stops draining out, replace the soft rubber stopper, and tighten the drain cover.
- 3) Remove the pan of water.
- 4) Operate the unit in Fan mode to dry the interior of the unit.

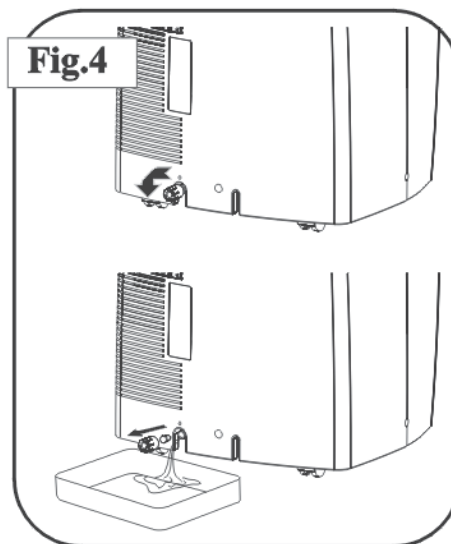

## OPERATION (cont'd)

### DEHUMIDIFIER

**Note:** During dehumidifier mode, the exhaust hose does not have to be vented outdoors.

- 1) Press the ON/OFF key pad to switch the unit on (Fig. G)
- 2) Press the MODE key (Fig. H) until the DRY indicator illuminates on the control panel (Fig.I). Each press of the MODE key will advance to a different mode setting (Cool-Dehumidifier-Fan-Heat).

**IMPORTANT:** There is no temperature adjustment during dehumidifier mode. If the room temperature is greater than 77°F (25°C), the fan speed can be adjusted, otherwise the fan speed is fixed at LOW speed.

**IMPORTANT:** The drain hose must be installed during dehumidifier mode. The function of continuous drain can be performed using the following steps:

- 1) To save having to periodically empty the water tank, this unit can be configured for continuous drain. You can use the supplied drain hose to connect to the continuous drain connector.
- 2) Unscrew and remove the drain cover at the rear of the unit (Fig.5).
- 3) Remove the soft rubber stopper, and place it in the water tank for safe keeping (Fig.6).
- 4) Insert the drain hose through the hole of the drain cover (Fig. 7).
- 5) Ensure the rubber seal ring is properly seated in the end of the hose as shown in Fig. 7.
- 6) Connect the drain hose to the drain port (Fig. 8).
- 7) Tighten the drain cover in clockwise direction onto the rear of the unit (Fig. 8).

### INSTALLING PVC DRAIN HOSE

When using the continuous drain function, the PVC hose must be placed horizontally below the drainage hole. Avoid uneven ground and folding the hose.

**NOTE:** Should you damage or misplace the pvc drain hose, a standard garden hose can be used.

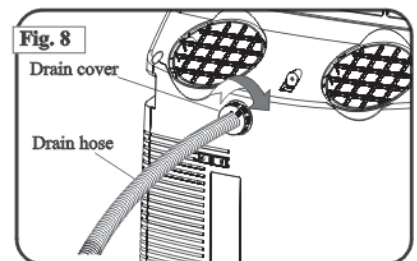
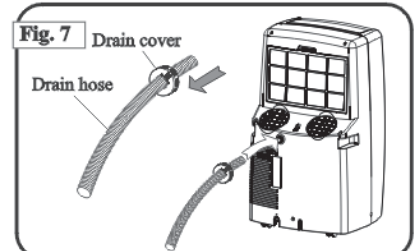
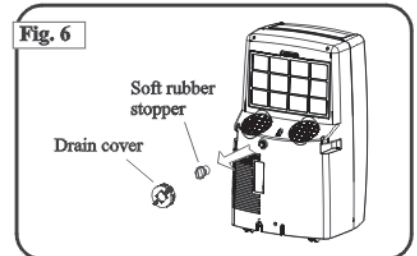
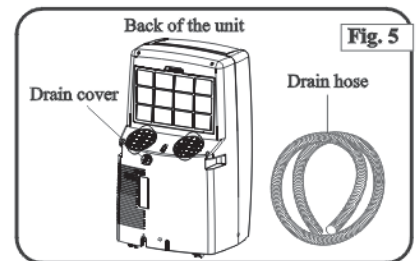
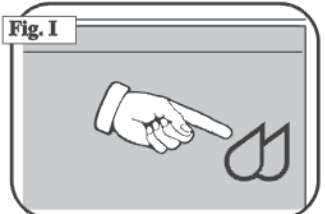
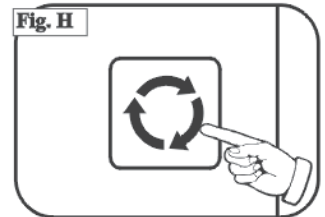
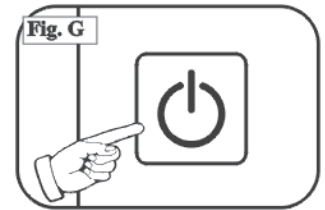
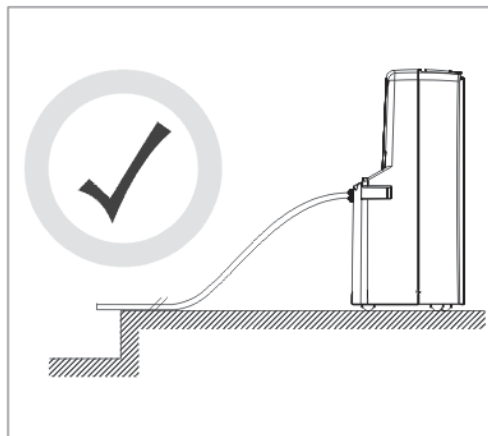
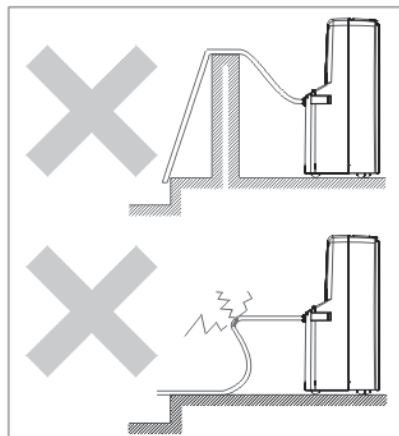



## OPERATING INSTRUCTIONS (cont'd)

### FAN

**Note:** During Fan Mode, the exhaust hose does not have to be vented outdoors.

- 1) Press the POWER SWITCH key to turn the unit on (Fig. J).
- 2) Press the MODE key (Fig. K) until the FAN indicator illuminates on the control panel (Fig. L). Each press of the MODE key will advance to a different mode setting (Cool-Dehumidifier-Fan-Heat).
- 3) Press the FAN Key (Fig. M) to select the desired FAN SPEED setting. Your selection will appear on the control panel. Each press of the fan key will advance to a different fan speed (High- Med- Low) as shown in Fig. N.

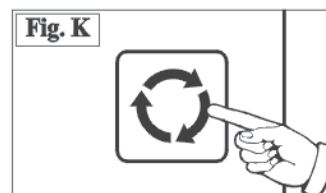
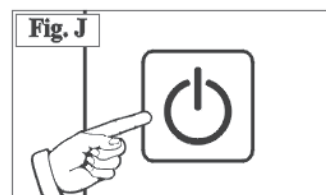

### HEAT

**Note:** During Heat Mode, the exhaust hose does not have to be vented outdoors.

- 1) Press the POWER SWITCH key (Fig. J) to switch on the unit, and the previous set temperature will be shown in the temperature display area of the control panel.
- 2) Press the MODE key (Fig. K) until the Heat indicator light illuminates on the control panel (Fig. O). Each depression of the MODE key will advance to a different mode setting (Cool- Dehumidifier- Fan- Heat).
- 3) Press the appropriate increase "+" or decrease "-" buttons (Fig P) to select a suitable operating temperature setting. Temperature settings are adjustable between 16°C (61°F) to 25°C (77°F).
- 4) Press the FAN key (Fig. M) to select the desired fan speed setting (High- Med.- Low). Your selection will appear on the control panel (each depression of the fan key will advance to a different setting)

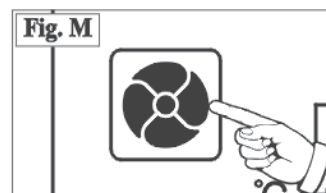
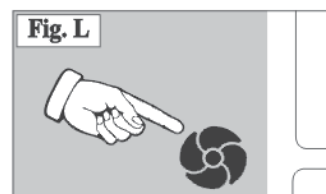

- Heating stops automatically when the set temperature is achieved. Heating resumes when the room temperature rises above the "set" temperature level.

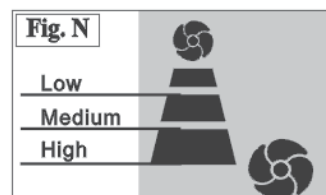
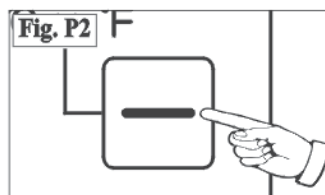
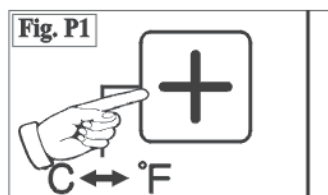
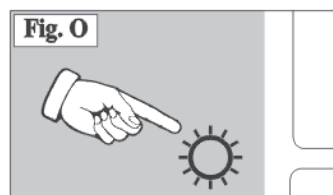

## OPERATION (cont'd)

**AUTO-TIMER** The AUTO-TIMER feature offers a unique selection of multiple choice, fully automatic on and/or off (start/stop) programs between 1-24 hours under any one mode of your Home Comfort unit.

The programs are as follows:

- a) Auto-Off: Pre-select a time that will turn off the unit automatically (between 1-24hrs).      b) Auto-On: Pre-select a time that will turn on the unit automatically (between 1-24hrs).

### REMOTE CONTROL FEATURES

#### Control Buttons:

1) Power Switch

2) Mode

3) Fan Speed

4) On / Off Timer

5) Time / Temperature Set

• Used for adjusting the timer and temperature.

• The default display on control panel is room temperature.

• When "+" or "-" key is pressed in cool mode, the set temperature is displayed and may be adjusted. After 15 seconds, the display will revert back to room temperature.

• Timer setting is available from 1-24 hours by pressing "+" or "-" keys.

To operate the hand held remote control you will require two "AAA" Alkaline batteries (included).

#### Batteries should be replaced when:

a) No signal (beep) is heard when attempting to program the main unit.

b) The main unit does not respond to a command issued by the remote control.

**Battery replacement:** Replace batteries as a simultaneous set.

1) Slide the rear cover on the remote in the direction of the arrow. Continue pulling (gently) until the cover separates completely from the unit.

2) Insert (2) batteries (AAA) following the same orientation (polarity) depicted inside the battery chamber (+ / -).

3) Re-install rear cover.

4) If the remote control will not be used for extended periods of time, batteries should be removed.

The remote operates within a range of 8 meters (26 ft.) from the receiver located inside the main unit. Any obstruction between the receiver and remote may cause signal interference, limiting the ability to program the unit.

#### Notes:

1) Do not drop the remote control.

2) Do not place the remote control in a location exposed to direct sunlight.

3) The remote control should be placed about 1 meter or more away from TV, or any electrical appliances.

**This Class B digital apparatus complies with canadian ICES-003.**

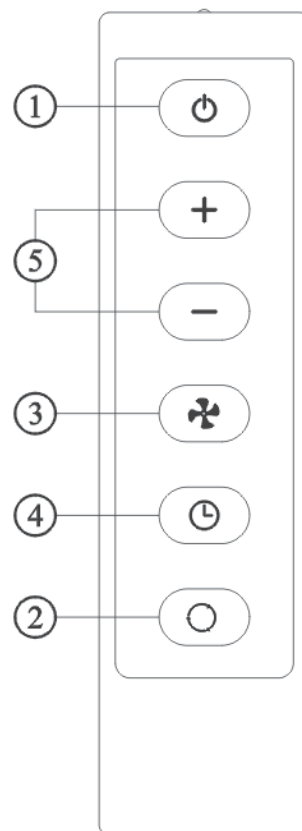

## CARE AND MAINTENANCE

### CLEANING THE UNIT

**CAUTION:** Before cleaning or servicing this unit, disconnect from any electrical supply outlet.

- 1) DO NOT use gasoline, benzene, thinner, or any other chemicals to clean this unit, as these substances may cause damage to the finish and deformation of plastic parts.
- 2) Never attempt to clean the unit by pouring water directly over any of the surface areas, as this will cause deterioration of electrical components and

wiring insulation.

- 3) Unplug the unit.
- 4) Clean the unit by wiping off any dirt/dust with a soft damp cloth or vacuum cleaner, then wipe dry with a dry soft cloth.

**CAUTION:** Always store the unit in vertical position. DO NOT put heavy objects on top of the unit.

### CLEANING THE AIR FILTER

**CAUTION:** Never operate this unit without the air filter in place, as this may result in damage to the unit.

If the air filter becomes clogged with dust/dirt, air flow is restricted, which reduces cooling efficiency. The air filter should be **cleaned every two (2) weeks**. More frequent cleaning may be necessary depending on indoor air quality.

**NOTE:** The air filter is located at the upper rear side of the unit.

- 1) To remove the air filter: Pull the air filter cover upward in the direction of the arrow (Fig. 4) and remove the air filter.
- 2) Dust/dirt clogged in the filter can be removed by vacuum cleaning the soiled areas.
- 3) The filter can also be washed in lukewarm, soapy water while rubbing it lightly with a brush. A mild detergent (dishwashing liquid) is recommended.
- 4) Rinse the filter well using clean water. **Allow time to dry before reinstalling into the unit.**
- 5) Replace the air filter and cover.
- 6) Replacement air filter information is available by contacting the Customer Service Department at: 1-800-26-**Danby**® (1-800-263-2629).

Fig. 4

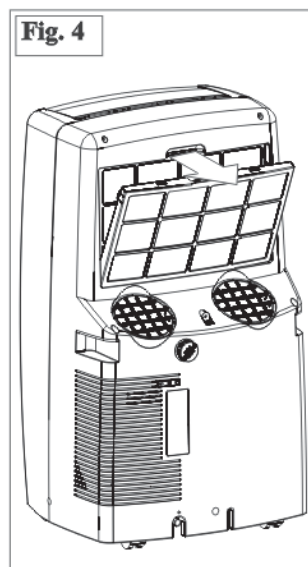

## TROUBLESHOOTING

Occasionally, a problem may occur that is minor, and a service call may not be necessary. Use this troubleshooting guide for a possible solution. If the unit continues to operate improperly, call an authorized service depot for assistance, or Danby's Toll Free Number: **1-800-26-Danby®**

PROBLEM	POSSIBLE CAUSE	SOLUTIONS
1) Unit does not work	<ul style="list-style-type: none"> <li>• Power is out.</li> <li>• The plug is not plugged in properly.</li> <li>• The full-tank indicator is ON; tank is full.</li> <li>• Current leaking or pressing test button on LCDI plug.</li> </ul>	<ul style="list-style-type: none"> <li>• Wait for power to return.</li> <li>• Plug in properly.</li> <li>• Remove drain water from the drain tank.</li> <li>• Press the reset button after resolving problem.</li> </ul>
2) Unit suddenly stops during operation.	<ul style="list-style-type: none"> <li>• Indoor set temperature has been reached.</li> <li>• The preset time is up.</li> <li>• The full-tank indicator is ON; tank is full.</li> </ul>	<ul style="list-style-type: none"> <li>• Reset the temperature level.</li> <li>• Reset the timer.</li> <li>• Remove drain water from the drain tank.</li> </ul>
3) Unit runs intermittently	<ul style="list-style-type: none"> <li>• Malfunction.</li> <li>• Surrounding temp. is too high/low.</li> <li>• Exhaust duct hose is blocked.</li> </ul>	<ul style="list-style-type: none"> <li>• Contact your dealer.</li> <li>• This is normal.</li> <li>• Check the duct hose.</li> </ul>
4) Unit functions but the room is not cooled.	<ul style="list-style-type: none"> <li>• Window or door is open in room.</li> <li>• There is a heat source or too many people in the room.</li> <li>• Air intake grill is clogged.</li> <li>• Filter is too dirty.</li> <li>• Temperature setting is too high.</li> </ul>	<ul style="list-style-type: none"> <li>• Close all windows/doors.</li> <li>• Move any heat sources from room.</li> <li>• Clean air intake grill.</li> <li>• Replace the filter.</li> <li>• Lower temp. setting.</li> </ul>
5) Condensed water spills out when moving the unit.	<ul style="list-style-type: none"> <li>• The tank is nearly full.</li> </ul>	<ul style="list-style-type: none"> <li>• Remove drain plug on rear bottom and drain out water.</li> </ul>

**Danby**  
**Premiere.**

## LIMITED IN-HOME APPLIANCE WARRANTY

This quality product is warranted to be free from manufacturer's defects in material and workmanship, provided that the unit is used under the normal operating conditions intended by the manufacturer.

This warranty is available only to the person to whom the unit was originally sold by Danby Products Limited (Canada) or Danby Products Inc. (U.S.A.) (hereafter "Danby") or by an authorized distributor of Danby, and is non-transferable.

### TERMS OF WARRANTY

Plastic parts, are warranted for thirty (30) days only from purchase date, with no extensions provided.

*First 24 Months* During the first twenty four (24) months, any functional parts of this product found to be defective, will be repaired or replaced, at warrantor's option, at no charge to the ORIGINAL purchaser.

*To obtain Service* Danby reserves the right to limit the boundaries of "In Home Service" to the proximity of an Authorized Service Depot. Any appliance requiring service outside the limited boundaries of "In Home Service", it will be the consumer's responsibility to transport the appliance (at their own expense) to the original retailer (point of purchase) or a service depot for repair. See "Boundaries of In Home Service" below. Contact your dealer from whom your unit was purchased, or contact your nearest authorized Danby service depot, where service must be performed by a qualified service technician.  
If service is performed on the unit by anyone other than an authorized service depot, or the unit is used for commercial application, all obligations of Danby under this warranty shall be void.

*Boundaries of In Home Service* If the appliance is installed in a location that is 100 kilometers (62 miles) or more from the nearest service center your unit must be delivered to the nearest authorized Danby Service Depot, as service must only be performed by a technician qualified and certified for warranty service by Danby. Transportation charges to and from the service location are not protected by this warranty and are the responsibility of the purchaser.

Nothing within this warranty shall imply that Danby will be responsible or liable for any spoilage or damage to food or other contents of this appliance, whether due to any defect of the appliance, or its use, whether proper or improper.

### EXCLUSIONS

Save as herein provided, Danby, there are no other warranties, conditions, representations or guarantees, express or implied, made or intended by Danby or its authorized distributors and all other warranties, conditions, representations or guarantees, including any warranties, conditions, representations or guarantees under any Sale of Goods Act or like legislation or statute is hereby expressly excluded. Save as herein provided, Danby shall not be responsible for any damages to persons or property, including the unit itself, howsoever caused or any consequential damages arising from the malfunction of the unit and by the purchase of the unit, the purchaser does hereby agree to indemnify and hold harmless Danby from any claim for damages to persons or property caused by the unit.

### GENERAL PROVISIONS

No warranty or insurance herein contained or set out shall apply when damage or repair is caused by any of the following:

- 1) Power failure.
- 2) Damage in transit or when moving the appliance.
- 3) Improper power supply such as low voltage, defective house wiring or inadequate fuses.
- 4) Accident, alteration, abuse or misuse of the appliance such as inadequate air circulation in the room or abnormal operating conditions (extremely high or low room temperature).
- 5) Use for commercial or industrial purposes (ie. If the appliance is not installed in a domestic residence).
- 6) Fire, water damage, theft, war, riot, hostility, acts of God such as hurricanes, floods etc.
- 7) Service calls resulting in customer education.
- 8) Improper Installation (ie. Building-in of a free standing appliance or using an appliance outdoors that is not approved for outdoor application).

Proof of purchase date will be required for warranty claims; so, please retain bills of sale. In the event warranty service is required, present this document to our AUTHORIZED SERVICE DEPOT.

**Warranty Service**  
In-home

Danby Products Limited  
PO Box 1778, Guelph, Ontario, Canada N1H 6Z9  
Telephone: (519) 837-0920 FAX: (519) 837-0449

**1-800-263-2629**

04/09

Danby Products Inc.  
PO Box 669, Findlay, Ohio, U.S.A. 45840  
Telephone: (419) 425-8627 FAX: (419) 425-8629

# Danby Premiere®

Model • Modèle  
DPAC13012H

For service, contact your  
nearest service depot or call:

**1-800-26- Danby®**  
**(1-800-263-2629)**

to recommend a depot in  
your area.

Pour obtenir le service,  
consultez votre centre de  
service le plus rapproché ou  
composez le:

**1-800-26- Danby®**  
**(1-800-263-2629)**

vous recommandera un  
centre régional.

## PORTABLE AIR CONDITIONER

The model number can be found on the serial plate located on the back panel of the unit.

All repair parts are available for purchase or special order when you visit your nearest service depot. To request service and/or the location of the service depot nearest you, call the TOLL FREE NUMBER.

When requesting service or ordering parts, always provide the following information:

- **Product Type**
- **Model Number**
- **Part Number**
- **Part Description**

## CLIMATISEUR PORTATIF

Le numéro de modèle se trouve sur la plaque d'information sur le panneau arrière de l'appareil.

Toutes les pièces de rechange ou commandes spéciales sont disponibles à votre centre de service régional autorisé. Pour obtenir le service et/ou la localité de votre centre de service régional, signalez le NUMÉRO D'APPEL SANS FRAIS.

Ayez les renseignements suivants à la portée de la main lors de la commande de pièce ou service:

- **Type de produit**
- **Numéro de modèle**
- **Numéro de pièce**
- **Description de la pièce**

Danby Products Ltd, Guelph, Ontario Canada N1H 6Z9  
Danby Products Inc, Findlay, Ohio USA 45840