

# ROOM AIR CONDITIONERS

WINDOW | THRU-THE-WALL | PORTABLE | HAZARDOUS LOCATION



FRIEDRICH

1883

earth friendly



# TABLE OF CONTENTS

What Type of Air Conditioner Do You Need? \_\_\_\_\_ PAGE 3

## WINDOW AIR CONDITIONERS

Window Air Conditioner Selector Guide \_\_\_\_\_ PAGE 4

Room Air Conditioner Sizing Guide \_\_\_\_\_ PAGE 5

Kühl Series \_\_\_\_\_ PAGES 6-12

Kühl Accessories \_\_\_\_\_ PAGE 13

New Chill Series \_\_\_\_\_ PAGE 14,15

Specifications \_\_\_\_\_ PAGE 16

Installation \_\_\_\_\_ PAGE 17

## THRU-THE-WALL AIR CONDITIONERS

Thru-the-wall Air Conditioner Selector Guide \_\_\_\_\_ PAGE 18

Products \_\_\_\_\_ PAGES 19-23

Accessories & Installation \_\_\_\_\_ PAGE 24

Specifications \_\_\_\_\_ PAGE 25

## PORTABLE AIR CONDITIONERS

Products \_\_\_\_\_ PAGES 26,27

Specifications & Installation \_\_\_\_\_ PAGE 28

## HAZARDOUS LOCATION ROOM AIR CONDITIONERS





Products \_\_\_\_\_ PAGE 29, 30

Specifications & Installation \_\_\_\_\_ PAGE 31

# WHAT TYPE OF AIR CONDITIONER DO YOU NEED?

	WINDOW AIR CONDITIONERS		THRU-THE-WALL		PORTABLE	HAZARDOUS LOCATION
	Kühl®	Chill™	WallMaster®	Uni-Fit®	ZoneAire®	Hazardgard®
PERMANENT	Y	Y	Y	Y	—	Y
SEASONAL	Y	Y	—	—	Y	—
CAN BE INSTALLED THRU-THE-WALL	Y	Y -except CP05	Y	Y	—	Y
ENERGY STAR	Y	Y	Y	Y	NA	NA
POWER SUPPLY						
115V	Y	Y	Y	Y	Y	—
230V	Y	Y	Y	Y	—	Y
COOLING W/ HEAT						
HEAT PUMP	Y	—	Y	—	Y	—
ELECTRIC HEAT	Y	Y	Y	Y	—	—
EXTRA LARGE CAPACITY						
>17,000 Btu	Y	Y	—	—	—	Y
>25,000 Btu	Y	—	—	—	—	—
SPECIAL OPTIONS						
ROLLS FROM ROOM TO ROOM	—	—	—	—	Y	—
ENHANCED FILTRATION	Y	—	—	—	—	—
DECORATOR COLORS	Y	—	—	—	—	—

# WINDOW AIR CONDITIONER SELECTOR GUIDE

		COMMERCIAL GRADE		RESIDENTIAL GRADE	
		Kühl®	Kühl+®	Chill™	Chill™+
OVERVIEW	Description	Bold design and exclusive features. Programmability to rival central systems. Trusted Friedrich durability. Designer colors.	All the performance and durability of Kühl, plus heating. Choose efficient heat pump or toasty electric heat.	Good value. Available in a large range of cooling capacities. Programmable timer.	Good value. Four models with electric heat. Programmable timer.
	Room size (sq. ft.)	100-2700	350-2700	100-1500	100-1500
	Functions	COOL 	HEAT/COOL 	COOL 	HEAT/COOL 
	Applications	COMMERCIAL AND RESIDENTIAL	COMMERCIAL AND RESIDENTIAL	RESIDENTIAL AND LIGHT COMMERCIAL	RESIDENTIAL AND LIGHT COMMERCIAL
COMFORT & CONVENIENCE	Electronic controls	Y	Y	Y	Y
	Programmable timer	7-day with up to 4 settings per day	7-day with up to 4 settings per day	24 hr.	24-hr.
	Remote control	LCD	LCD	LCD	LCD
	Remote Link Wi-Fi Control (with accessory)	Y	Y	—	—
	Wall thermostat capability	All except SQ models	All except EQ08	—	—
	Auto restart w/setting retention	Y	Y	Y	Y
	Auto temp/ fan speed adjustment	Y	Y	—	—
	Comfortwatch technology	Y	Y	—	—
	Air flow directions	8	8	4	4
	Auto swing louvers	—	—	All except CP05	Y
Optional color fronts	Y	Y	—	—	
SOUND REDUCTION TECHNOLOGY	Steel inner wall and extra dense insulation	Y	Y	—	—
	Vibration isolating design and components	Y	Y	—	—
	Superior airflow design	Y	Y	—	—
EARTH FRIENDLY	ENERGY STAR® models	Y	Y	Y	Y
	SmartGrid capable	Y	Y	—	—
	Environmentally friendly R-410A	Y	Y	Y	Y
	Energy saver switch	Y	Y	Y	Y
	RoHS compliant	Y	Y	—	—
HEALTH	Washable, antimicrobial air filter	Y	Y	Y	Y
	Optional carbon filter	Y	Y	—	—
	Check filter reminder	Y	Y	—	—
	Superior fresh air intake/stale air exhaust	Y	Y	Stale air exhaust only, all except CP05	Stale air exhaust only
SAFETY	EntryGard™ anti-intrusion protection	Y	Y	Y	Y
	Insect barrier	Y	Y	—	—
INSTALLATION	Slideout chassis	Y	Y	All except CP05	Y
	Power cord direction	Left or right	Left or right	Left or right	Left or right
	Thru-the-wall installation option	Y	Y	All except CP05	Y
	Window installation hardware	Heavy duty	Heavy duty, available as accessory	Standard	Standard

## Product Selection Tools

These tools are only a guide. Due to variations in room design, local climate and occupancy, larger areas may require the use of multiple units to provide the optimal cooling solution. Please consult your local authorized Friedrich distributor or the Friedrich Technical Assistance team for sizing or application assistance.

### COOLING SIZING GUIDE

The cooling guide to the right is based on normal room insulation, average number of sun-exposed windows and two-person occupancy.

### HEATING SIZING INFORMATION

In heating mode, an energy efficient heat pump will generate slightly less heating Btus than it would in cooling mode. However, in heating mode, heat pumps use approximately 1/3 the energy of resistance heat, making them an excellent high efficiency alternative. Back-up resistance heat ensures heat operation below 40° F outdoor temperatures for year 'round comfort.

## Common Window Types

Traditional wooden windows are typical in many residences built before 1965, but more modern windows are often constructed of aluminum or vinyl. Many newer energy efficient windows like double-glazed windows actually sandwich low conductance gas between two panes of glass. While Friedrich air conditioners may be used with this type of window, care should be taken not to break the seal between the two panes of glass during installation.

Depending on the style of window in the application, you may want to consider the cooling solutions in the adjacent chart. Professional installers may be able to make field adaptations, including removing all or part of a window to support alternative types of air conditioning units. Professional installers should also be able to tell you about any local codes that may apply to your installation.

### THRU-THE-WALL INSTALLATION

Many models may be installed through a wall so long as the unit's side vents are not blocked or covered in any way. See page 15, In-wall Installation max. depth.

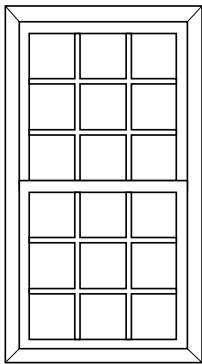

**Single/double hung**  
(Opens up or down)

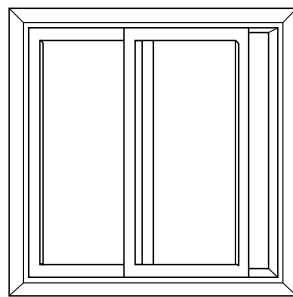

**Slider**  
(Opens left to right, or right to left)

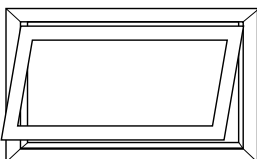

**Awning**  
(Cranks out)

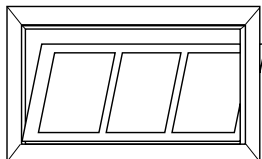

**Hopper**  
(Opens in)

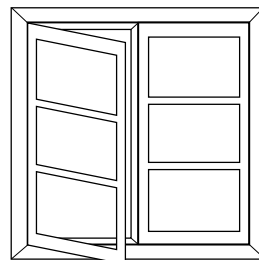

**Casement**  
(Cranks out)

## COOLING SIZING GUIDE

Area to be conditioned in sq. ft.	Cooling Btu
100 - 150	5000
150 - 250	6000
250 - 300	7000
300 - 350	8000
350 - 400	9000
400 - 450	10000
450 - 550	12000
550 - 700	14000
700 - 1000	18000
1000 - 1200	21000
1200 - 1400	23000
1400 - 1600	25000
1600 - 1900	28000
1900 - 2700	36000

## Cooling Solutions

### WHICH AIR CONDITIONER IS RIGHT FOR YOU?

Window Type	Air Conditioner
Single/double hung	Window, portable, ductless
Slider	Window, portable, ductless
Casement	Window, portable, ductless
Vertical Casement	Window, portable, ductless
Awning	Window, portable, ductless
Hopper	Window, portable, ductless
Picture (non-opening)	Thru-the-wall, ductless

Kühl° Series

# COMMERCIAL GRADE ROOM CONDITIONERS

KÜHL  
DURABILITY

---

KÜHL  
TECHNOLOGY

---

KÜHL  
CONTROL



Wi-Fi  
READY



# QUALITY CONSTRUCTION

The **HIGHEST GRADE MATERIALS** are used to build a product that will perform reliably season after season.

**20 GAUGE STEEL** is used in order to create a more robust air conditioner cabinet that will withstand years of hard use.

**SOLID SLEEVE TOP\*** keeps out falling debris, which can obstruct the fan and prevent it from turning, thus damaging the unit.

**VIBRATION AND NOISE ISOLATING TECHNOLOGY.** Two resilient rings on motor mount prevent metal-to-metal contact, which eliminates extra vibration and noise.

**SOLID STEEL BLOWER WHEEL HOUSING**  
Blower wheel housing made of solid steel for maximum sound reduction.

**SCIENTIFIC REFRIGERATION DESIGN.**  
Better design for quieter performance.

\* Feature not on Kühl SQ and EQ models

**RIFLED COPPER TUBING** with greater surface area for heat exchange, which increases the efficiency of the coils, and improves the overall energy efficiency of the unit.

**INSULATED PLENUM** prevents outside air intrusion.

**ENTRYGARD™ KICK-IN INTRUSION PROTECTION.** Steel retaining wire secures chassis to the sleeve to deter 'kick-in' intrusion.

**FIRM GRIP HANDLES** make grasping the chassis for installation and removal much easier.

**ALUMINUM REAR GRILLE** protects the unit from damage and vandalism. No one else offers this feature.

# SUPERIOR COMPONENTS

What makes Friedrich Kühl ultra premium?

Superior components like **ROBUST, COMMERCIAL GRADE FAN MOTORS** that run at a lower temperature than smaller fan motors prevent the unit from overheating and contribute to a longer life. **FAN MOTORS ARE ALSO TOTALLY ENCLOSED** for maximum protection and longer life.

**HIGH EFFICIENCY COMPRESSORS** mounted on **LARGE, VIBRATION-ABSORBING GROMMETS** create smooth, quiet power.

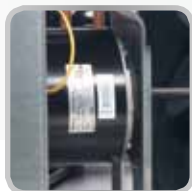

Totally enclosed motor



Rifled copper tubing



Aluminum fins



Vibration-isolating grommets



High efficiency compressors



# KÜHL® TECHNOLOGY KÜHL® CONTROL

Kühl® offers more ways to customize your cooling experience than you ever thought possible in a window air conditioning solution.



## CONTROL WITH YOUR SMARTPHONE OR COMPUTER

Adjust your Kühl air conditioner from your smart phone or computer to control the comfort in your home and reduce energy costs.\*



\*Optional accessory required.

KÜHL  
DURABILITY

KÜHL  
TECHNOLOGY

KÜHL  
CONTROL





# SIMPLE 'ONE-TOUCH' OPERATION OR COMPLETE CONTROL

**Kühl units are Smart Grid capable and you can use Wi-Fi to control your unit from a smartphone or computer.**

## SIMPLE OPERATION

Turn the unit on, select 'MODE' and make simple up/down temperature adjustments either at the control panel or with included remote. Unit operates until turned off.

## BUILT-IN 7 DAY PROGRAMS

All Kühl units include two 7-day energy management programs which can be accessed and selected from the unit's controls. Selecting the '40 Hr. Work Week' residential schedule causes Kühl to raise the room temperature temporarily during the hours when most people are away at work and lower them again prior to the time when most people will return home. Selecting the '5-Day Business Week' commercial schedule tells the unit to raise temperatures after typical working hours and on weekends when commercial spaces are typically unoccupied.

## CUSTOM 7-DAY PROGRAM (requires optional accessory)

If you would rather customize your own 7-day energy management program, an optional Wi-Fi adapter (KWIFI accessory) can be used in conjunction with your computer to schedule up to four temperature adjustments per day of the week. Maximize comfort and energy savings by creating the schedule that's right for you. Custom schedules can either be uploaded to the unit via the air conditioner's built-in micro USB interface or transmitted wirelessly, as explained below, greatly simplifying the programming of one or multiple units.

## FRIEDRICHLINK™ WI-FI OPERATION (requires optional accessory)

Kühl units can be controlled wirelessly over a Wi-Fi network. Adding a Friedrich KWIFI accessory (Wi-Fi adapter) to your Kühl unit will allow you to control it online using either a computer or a smartphone. A web-based control portal on Friedrich.com will allow you to access individual or multiple units for monitoring, control or even diagnostics.



## BUILDING MANAGEMENT SYSTEM-BMS (requires optional accessory)

The optional KWIFI accessory also allows Kühl units to be controlled remotely via a BMS: manage one or groups of units, create custom schedules and even run unit diagnostics. The web-based control portal on Friedrich.com will allow you to access individual or multiple units for monitoring, control or even diagnostics.

## REMOTE THERMOSTAT OPERATION

With the optional thermostat adapter, the unit can be wired to a wall thermostat\* and operated remotely. Wall thermostats are available from Friedrich and many retailers, and are sold separately.

## SMART GRID CAPABLE

Kühl is the first room air conditioner that can tie into a power company's smart grid. A grid is a network that brings electricity from power stations to consumers. New technologies allow power companies to adjust electrical loads of residential users based on their specific needs - this is called a 'smart grid'. Smart grid helps consumers to be better informed about their electricity usage and allows electric utility companies to serve customer demand in the most efficient way.

For example, during a hot summer afternoon when AC units are running at full capacity, the smart grid can send information to recalibrate other loads, which helps to alleviate stress on the system as a whole.

Source: SGIC (Smart Grid Information Clearinghouse)

## Intuitive controls.

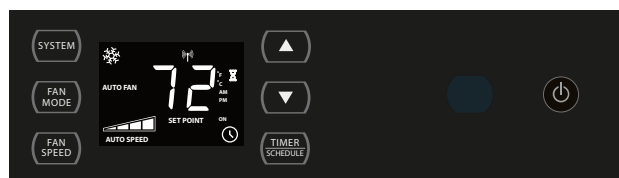

LCD panel auto dims when not in use

Nightlight mode

Temperature and fan adjustment maintain your desired comfort level

Back up system saves settings if power is interrupted

Two built-in 7-day programs

24-hr. timer

Audio feedback option

Auto restart returns unit to previous settings if power is interrupted

Displays set temperature and room temperature

Check filter reminder

Keypad lockout option (ON/OFF) protects settings

\*Wired thermostat option not available on Kühl SQ and EQ models.

KÜHL  
TECHNOLOGY

KÜHL  
CONTROL

KÜHL  
COLORS



## 6 OPTIONAL COLORED FRONTS SOLD AS AN ACCESSORY KIT.

Kühl's streamlined modern design in Neutral Gray can blend in with any décor. Or coordinate a look that complements your space by using any of the six colored front covers (sold separately at retailers or at [friedrich.com](http://friedrich.com)).



Neutral Gray  
( S T A N D A R D )



# WINDOW AIR CONDITIONERS

## KÜHL® ULTRA PREMIUM LINE

The centralized control and convenience of a central air conditioning system.

You'll find more options, features and ways to customize your cooling experience than you ever thought possible in a window air conditioning solution.

### NEW COMPACT CHASSIS SIZE



Full LCD display shows MODE, FAN SPEED, SET TEMPERATURE and SCHEDULE. Adjust TEMPERATURE and FAN SPEEDS, set AUTO MODE and turn the SCHEDULE ON/OFF.

#### Kühl®

5500-9500 Btu  
Up to 10.7 EER

#### Kühl® + EQ08 *Electric Heat*

COOLING  
7500 Btu  
Up to 9.8 EER  
ELECTRIC HEAT  
4000 Btu



#### Kühl®

7900-36000 Btu  
Up to 11.7 EER

#### Kühl® + *Electric Heat*

COOLING  
11500-36000 Btu  
Up to 11.4 EER  
ELECTRIC HEAT  
10700-17300 Btu

#### Kühl® + *Heat Pump*

COOLING  
9500-24000 Btu  
Up to 11.7 EER  
HEATING  
7500-23500 Btu



# KÜHL FEATURES

## Comfort & Convenience

- Optional Remote Link Wi-Fi Control including multi-unit control options
- 2 ready-to-go 7-day energy management programs
- Download a customizable, 7-day program from our website and transfer to your Kühl unit using a micro USB cable and computer or create a custom program with optional Wi-Fi accessory
- 24-hour timer
- Optional wired wall thermostat\*
- 4 cooling and 4 fan-only speeds on select models
- Automatic fan speed adjustment
- Comfortwatch technology samples the air to more accurately maintain the set temperature
- 8-way air flow control
- Temperature readout can display set temperature and room temperature
- Control panel lockout (ON/OFF)
- Scratch resistant cabinet
- LCD panel auto dims if not in use
- Nightlight mode

\*Wired thermostat option not available on Kühl SQ and EQ models.

\*\*Nut driver not required for Kühl SQ and EQ models.

## Superior Sound Reduction Technology

- Steel inner wall and extra dense insulation materials block outdoor noise
- Vibration isolating design and components diminish traditional operating noise
- Precision engineering maximizes air flow while delivering ultraquiet operation

## Superior Filtration

- Superior fresh air intake and stale air exhaust vent
- Washable, antimicrobial air filter
- Check filter reminder
- Optional premium filter when used in conjunction with standard filter provides superior air filtration with ratings as high as MERV 6, while also adsorbing odors and reducing ozone and VOCs
- Hinged door for easy filter access for easier maintenance

## Installation Features

- Install in a window or thru-the-wall
- Slideout chassis for more permanent installation and easier access for maintenance
- Includes heavy duty window installation hardware (optional accessory on Kühl+ models)
- Rugged hardboard side panels or (heavy duty side curtains on SQ and EQ models) for a more permanent installation
- Power cord can run either left or right
- Firm grip handles for easier chassis installation and removal
- Front cover attaches easily and securely. Nut driver included\*\*.

## Earth Friendly

- Smart Grid capable
- Auto Fan mode saves money by conserving energy
- 16 ENERGY STAR® qualified models, including four heat pumps
- Environmentally-friendly R-410A refrigerant used in all models
- Recyclable packaging
- RoHS compliant

## Safety & Security Features

- EntryGuard™ anti-intrusion protection—steel retaining wire secures the chassis to the sleeve to deter 'kick-in' intrusion
- Powercord leakage current protected
- Insect barrier
- Protective rear grille



RECYCLABLE  
PACKAGING



R-410A  
OZONE FRIENDLY  
REFRIGERANT

# KÜHL ACCESSORIES

## PREMIUM CARBON FILTERS

Remove odors and VOCs (volatile organic compounds). Achieve up to a MERV 6 rating when used with standard filter. Sold in packs of 3.



Model	Kit No.
All SQ and EQ Models	KWCFQ
All SS, ES and YS Models	KWCFS
All SM, EM and YM Models	KWCFM
All SL, EL and YL Models	KWCFL

## KWIFI

USB thumbdrive and Wi-Fi dongle connect to unit control to allow for remote access and programming. Control from a computer, mobile device or building management interface.



## WINDOW MOUNTING KIT FOR KÜHL+ MODELS.

Heavy duty kits required for installation of these models in a window.

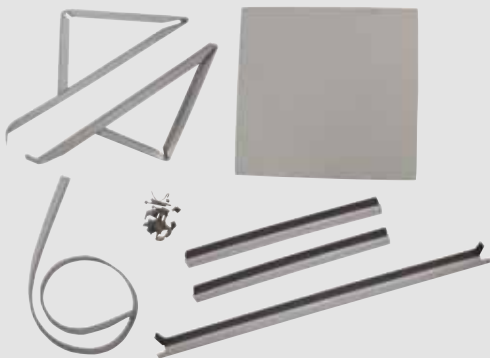

Heat/Cool Models	Kit No.
EQ08N11	KWIKQ
ES12N33, ES15N33, YS10N10 and YS12N33.	KWIKS
EM18N34, EM24N34 and YM18N34.	KWIKM
EL36N35 and YL24N35.	KWIKL

## DECORATIVE COLORED FRONT COVERS

Colored front cover kits available in six colors



Pink Diamond



Cobalt Blue



Designer White



Deep Red



Black Onyx

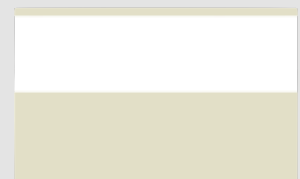

Classic Beige

	Color Front	Deep Red	Cobalt Blue	Classic Beige	Designer White	Black Onyx	Pink Diamond
Model	Kit No.						
All SQ and EQ Models	KWREDQ	KWBLUQ	KWBGEQ	KWWHTQ	KWBLKQ	KWPKNQ	
All SS, ES and YS Models	KWREDS	KWBLUS	KWBGES	KWWHTS	KWBLKS	KWPNKS	
All SM, EM and YM Models	KWREDM	KWBLUM	KWBGEM	KWWHTM	KWBLKM	KWPNKM	
All SL, EL and YL Models	KWREDL	KWBLUL	KWBGEL	KWWHTL	KWBLKL	KWPKNL	

## DRAIN KITS FOR USE WITH KÜHL SERIES

Drain tube field installed to the bottom on the base pan.

Model	Kit No.
All Kühl Series Models	DC2

## RT6 REMOTE THERMOSTAT

Digital thermostat for remote operation of Friedrich Kühl SS, SM and SL models and Kühl+ ES, EM, EL, YS, YM and YL models.



## KWSTAT

Thermostat adapter allows unit to operate with a wired remote wall thermostat.

## NEW CHILL™ SERIES PREMIUM LINE

Convenience features with energy efficient operation, including new heat/cool models.

Our efficient line of room air conditioners with programmable controls for convenient operation



Select MODE, FAN SPEED, adjust TEMPERATURE and set the TIMER.



CP05

Chill™  
5450 Btu  
10.7 EER

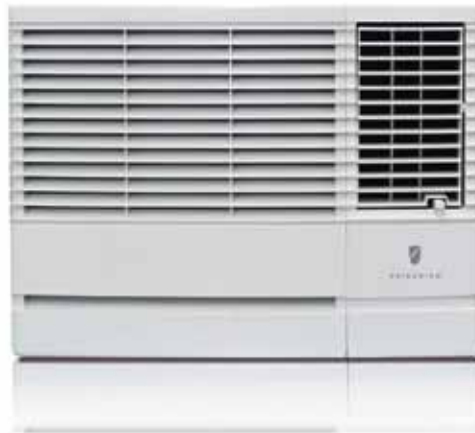

Chill™  
6000-23000 Btu  
Up to 10.8 EER

Chill™+  
*Electric Heat*  
COOLING  
8000-23000 Btu  
Up to 9.8 EER  
ELECTRIC HEAT  
3850-9800 Btu



Select MODE, FAN SPEED, adjust TEMPERATURE and set the TIMER.



## CP05, CP06, CP08, CP10 AND CP12

### Comfort & Convenience

- 24-hour timer lets you program on/off times
- Auto Air Sweep swing louvers\* provide more even air distribution
- 3 cooling speeds, plus 3 fan-only settings; 2 cooling speeds, 2 heating speeds, plus fan-only setting on Chill+
- Ultraquiet operation
- 4-way air flow control
- Auto restart saves settings if power is interrupted

### Energy Management & Compliance

- ENERGY STAR® qualified
- Money Saver® setting saves money by operating the fan only when cooling

\* Feature not available on CP05. \*\* CP05 has a fixed chassis and is for window installation only.

### Health & IAQ

- Washable, antimicrobial air filter
- Stale air exhaust

### Installation Features

- Slideout chassis\*
- Install in window or thru-wall\*\*
- Standard installation hardware
- Expandable side curtains
- Power cord can run either left or right out of the side of the unit front\*

### Safety & Security Features

- EntryGard™ anti-intrusion protection

Auto air sweep swing louvers for even cooling throughout the room.



Not available on CP05.

## CP15, CP18 AND CP24

### Comfort & Convenience

- 24-hour timer lets you program on/off times
- Auto Air Sweep swing louvers provide even air distribution
- 3 cooling speeds, plus 3 fan-only settings; 2 cooling speeds, 2 heating speeds, plus fan-only setting on Chill+
- Ultraquiet operation
- 4-way air flow control
- Auto restart saves settings if power is interrupted

### Energy Management & Compliance

- ENERGY STAR® qualified
- Money Saver® setting saves money by operating the fan only when cooling

### Health & IAQ

- Washable, antimicrobial air filter
- Stale air exhaust

### Installation Features

- Slideout chassis
- Install in window or thru-the-wall
- Standard installation hardware
- Expandable side curtains
- Power cord can run either left or right out of the side of the unit front

### Safety & Security Features

- EntryGard™ anti-intrusion protection



RECYCLABLE  
PACKAGING



R-410A  
OZONE FRIENDLY  
REFRIGERANT

# SPECIFICATIONS

★ ENERGY STAR® models

MODEL	Cooling Btu	Heating Btu	Volts Rated	Cooling Amps	Cooling Watts	Heating Amps	Heating Watts	Energy Efficiency Ratio EER	Estimated Yearly Operating Cost	Moisture Removal-Pints/HR	CFM	Sleeve	Net Wt	Ship Wt.
Kühl®														
★ SQ05N10	5500	-	115	4.5	514	-	-	10.7	\$41	-	0.5	190	Q	65 78
★ SQ06N10	5900	-	115	4.9	561	-	-	10.7	\$45	-	0.5	190	Q	71 84
★ SQ08N10	7500	-	115	6.1	700	-	-	10.7	\$56	-	1.2	240	Q	71 84
★ SQ10N10	9500	-	115	8.4	969	-	-	9.8	\$77	-	2.1	240	Q	75 88
★ SS08N10	7900	-	115	6.1	677	-	-	11.7	\$54	-	1.0	265	S	99 121
★ SS10N10	9500	-	115	7.7	848	-	-	11.2	\$68	-	2.0	260	S	106 136
★ SS12N10	12000	-	115	10.0	1071	-	-	11.2	\$86	-	3.0	300	S	112 136
★ SS14N10	14000	-	115	12.0	1444	-	-	9.7	\$115	-	3.5	325	S	116 133
★ SS12N30	11500/11200	-	230/208	4.8/4.9	1055/1027	-	-	11.4/11.4	\$84	-	2.8	275	S	112 134
★ SS15N30	14500/14300	-	230/208	6.4/6.8	1480/1459	-	-	9.8/9.8	\$112	-	3.5	360	S	116 136
★ SM15N10	14800	-	115	12.0	1358	-	-	10.9	\$109	-	3.5	360	M	141 154
★ SM18N30	17500/17200	-	230/208	7.4/8.0	1635/1607	-	-	10.7/10.7	\$131	-	4.6	350	M	140 158
★ SM21N30	20800/20700	-	230/208	9.4/10.3	2080/2070	-	-	10.0/10.0	\$177	-	6.0	425	M	132 153
★ SM24N30	23500/23300	-	230/208	11.2/11.9	2500/2479	-	-	9.4/9.4	\$200	-	10.0	390	M	152 167
★ SL28N30	27800/27000	-	230/208	13.5/14.4	2926/2872	-	-	9.7/9.6	\$229	-	8.5	600	L	193 214
★ SL36N30	36000/35700	-	230/208	19.0/20.5	4235/4200	-	-	8.5/8.5	\$338	-	12.0	725	L	212 227
Kühl® + Heat Pump														
★ YS10N10*	9500	7500	115	7.8	812	7.6	743	11.7	\$65	3.0	1.9	285	S	109 131
★ YS12N33	12100/12100	9400/9000	230/208	5.2/5.4	1120/1120	5.6/5.8	1132/1139	10.8/10.8	\$89	2.4/2.3	3.0	265	S	115 136
★ YM18N34	18200/17800	15500/15400	230/208	8.5/8.9	1838/1798	8.5/8.7	1833/1761	9.9/9.9	\$147	2.5/2.6	5.4	370	M	141 152
★ YL24N35	24000/23600	23500/23200	230/208	11.1/12.0	2474/2433	12.2/14.3	2610/2575	9.7/9.7	\$198	2.6/2.6	7.0	600	L	197 212
Kühl® + Electric Heat														
★ EQ08N11	7500	4000	115	6.9	765	11.2	1290	9.8	\$61	-	1.9	175	Q	72 84
★ ES12N33	11500/11200	10700/8900	230/208	4.8/4.9	1055/1027	16.0/14.7	3500/2900	11.4/11.4	\$84	-	2.8	275	S	113 128
★ ES15N33	14500/14300	10700/8900	230/208	6.4/6.8	1480/1459	16.0/14.7	3500/2900	9.8/9.8	\$112	-	3.5	360	S	117 133
★ EM18N34	17500/17200	13000/10600	230/208	7.4/8.0	1635/1617	19.5/17.0	4200/3500	10.7/10.7	\$131	-	4.6	350	M	141 158
★ EM24N34	23500/23300	13000/10600	230/208	11.2/11.9	2500/2479	19.5/17.0	4200/3500	9.4/9.4	\$200	-	10.0	390	M	153 166
★ EL36N35	36000/35700	17300/14300	230/208	19.0/20.5	4235/4200	24.0/22.4	5500/4650	8.5/8.5	\$338	-	12.0	725	L	213 225
Chill™														
★ CP05G10	5450	-	115	4.8	510	-	-	10.7	\$41	-	1.5	140	P1	46 50
★ CP06G10	6000	-	115	5.1	560	-	-	10.7	\$45	-	1.8	200	P6	60 66
★ CP08G10	7800	-	115	6.8	720	-	-	10.8	\$58	-	2.2	250	P6	64 70
★ CP10G10	10000	-	115	8.5	920	-	-	10.8	\$73	-	3.0	300	P7	81 87
★ CP12G10	12000	-	115	10.2	1110	-	-	10.8	\$89	-	3.3	330	P7	87 93
★ CP15G10	15000	-	115	12.9	1400	-	-	10.7	\$112	-	4.0	400	P8	120 134
★ CP18G30	18000 /17500	-	230/208	8.1/7.6	1630/1680	-	-	10.7/10.7	\$130	-	4.5	520	P9	136 150
★ CP24G30	23500 /23000	-	230/208	12.4/11.4	2450/2500	-	-	9.4/9.4	\$196	-	6.8	590	P9	146 160
Chill™+														
★ EP08G11	8000	3850	115	7.5	820	11.0	1260	9.8	\$65	-	2.6	205	P6	60 66
★ EP12G33	12000 /11500	12000 /9800	230/208	5.8/5.5	1220 /1170	15.3/14.0	3500/2900	9.8/9.8	\$93	-	3.3	265	P7	87 93
★ EP18G33	18000 /17500	12000 /9800	230/208	9.0/8.3	1850 /1800	15.3/14.0	3500/2900	9.7/9.7	\$144	-	5.5	430	P9	136 150
★ EP24G33	23500 /23000	12000 /9800	230/208	13.2/12.2	2760 /2700	15.3/14.0	3500/2900	8.5/8.5	\$216	-	6.5	560	P9	146 160

\* Operates on 115 volt and is not equipped with supplemental heat. Will not provide heat at temperatures below 40°F. Friedrich room air conditioners are designed to operate in outdoor temperatures from 60°F to 115°F.

Kühl+ Heat Pump heating information (shown in red) indicates heat pump performance. Kühl+ and Chill+ Electric Heat heating information (shown in red) indicates electric heat strip performance. For Kühl+ Heat Pump electric heating performance refer to corresponding Kühl+ Electric Heat model.

As an ENERGY STAR® partner, Friedrich Air Conditioning Co. has determined that the selected ENERGY STAR® models meet the ENERGY STAR® guidelines for energy efficiency.

The consumer- through the AHAM Room Air Conditioner Certification Program- can be certain that the AHAM Certification Seal accurately states the unit's cooling and heating capacity rating, the amperes and the energy efficiency ratio.

Estimated yearly operating cost based on a 2007 national average electricity cost of 10.65 cents per kWh.

Due to continuing research in new energy-saving technology, specifications are subject to change without notice.





# INSTALLATION INFORMATION/SLEEVE DIMENSIONS

Sleeve	Height INCHES	Width INCHES	Depth with Front	Shell Depth to Louvers	Minimum Extension Into Room* INCHES	Minimum Extension Outside * INCHES	Window Width INCHES		In-wall Installation Finished Hole INCHES		
			INCHES <b>A</b>	INCHES <b>B</b>			Minimum**	Maximum	Height	Width	Max. Depth <b>C</b>
<b>Q</b>	14"	19 3/4"	21 3/8"	8 1/2"	5 1/2"	10 3/4"	22"	42"	14 1/4"	20"	8 1/2"
<b>P1†</b>	12"	18 1/2"	15"	5"	3 1/2"	10 3/4"	20 1/8"	36"	NOT FOR THRU-WALL		
<b>P6</b>	14"	18 3/8"	20 7/8"	8 1/8"	4 1/2"	11"	20 1/8"	36"	14 1/8"	18 7/8"	7 1/2"
<b>P7</b>	15"	23 5/8"	21 3/4"	8 3/4"	4 1/2"	12"	25 1/4"	39"	15 1/4"	23 7/8"	8"
<b>P8</b>	16 7/8"	26"	26 7/8"	10 1/4"	5 1/2"	16 5/8"	26 1/2"	42"	17 1/8"	26 1/4"	9"
<b>P9</b>	16 7/8"	26"	30 3/8"	10 1/4"	5 1/2"	19 1/2"	26 1/2"	42"	17 1/8"	26 1/4"	9"
<b>S</b>	15 15/16"	25 15/16"	29"	8 3/4"	5 3/4"	16 15/16"	27 3/8"	42"	16 3/16"	26 3/16"	7 3/8"
<b>M</b>	17 15/16"	25 15/16"	29"	8 3/4"	5 3/4"	16 15/16"	27 3/8"	42"	18 3/16"	26 3/16"	7 3/8"
<b>L</b>	20 3/16"	28"	35 1/2"	16 1/2"	5 3/8"	18 15/16"	29 7/8"	42"	20 3/8"	28 1/4"	15 1/8"





\* Minimum extensions when mounted in a window.

\*\* Minimum widths achieved using one side curtain assembly as opposed to both in a standard installation.

† Sleeve P1 does not have In-wall hole dimensions, as these units are fixed chassis and should not be installed In-wall.

NOTE: S, M and L sleeves may be installed in window with no side kits if properly installed.

## Circuit Rating/ Breaker

Model	Circuit Rating Breaker or T-D Fuse	Plug Face (NEMA#)	Power Cord Length (ft.)	Wall Outlet Appearance
CP05			7	
CP06G10, CP08G10, CP10G10, CP12G10 and CP15G10. EP08G11. All SQ MODELS. EQ08N11. SS08N10, SS10N10, SS12N10 and SS14N10. SM15N10. YS10N10.	125V - 15A	5 - 15P	6	
CP18G30. SS12N30, SS15N30, SM18N30 and SM21N30. EP12G33.	250V - 15A	6 - 15P	4	
CP24G30. SM24N30 and SL28N30. EP18G33 and EP24G33. ES12N33 and ES15N33. YS12N33.	250V - 20A	6 - 20P	4	
SL36N30. EM18N34, EM24N34 and EL36N35. YM18N34 and YL24N35.	250V - 30A	6 - 30P	4	

Sleeve Dimensions Drawing

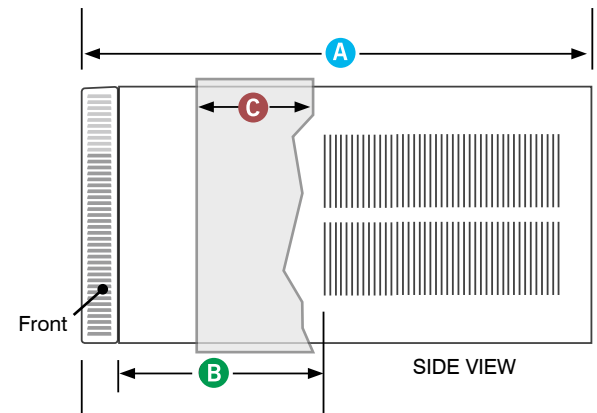

## Room Air Conditioner Model Identification Guide

**S L 28 N 3 0 A**

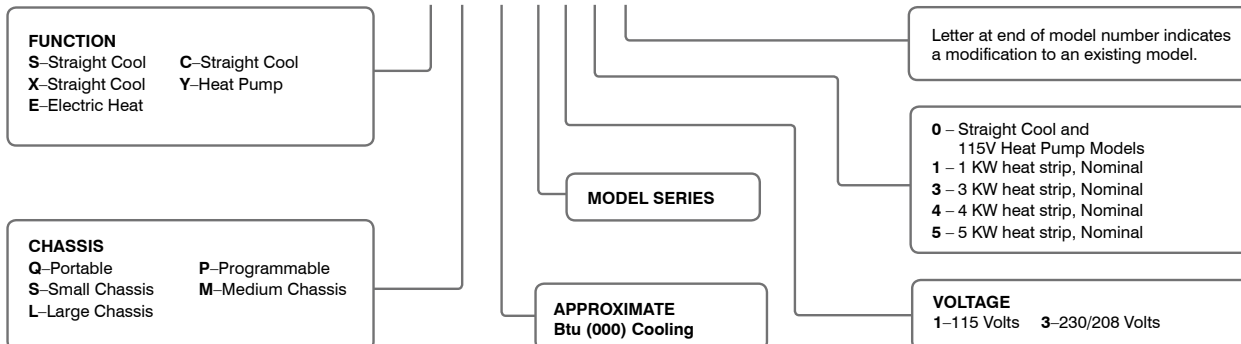

## WHEN SHOULD YOU INSTALL A SOLID SIDE SLEEVE?

A solid-side wall sleeve allows for installation in thick exterior walls where the installation of room air units with side vents would effect performance and may even void the warranty.

ROOM AIR CONDITIONER  
Blocked side vents restrict air flow

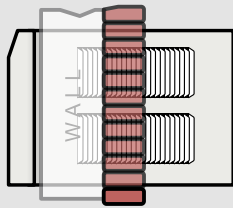

FRIEDRICH THRU-THE-WALL  
Solid-side sleeve (no side vents) can be installed in thicker walls. Sleeve can be positioned flush with exterior wall.

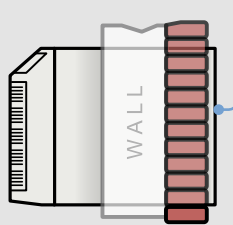

Or with minimum intrusion into the room.

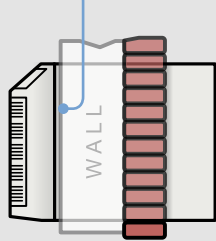

		THRU-THE-WALL MODELS	
		WallMaster®	Uni-Fit®
OVERVIEW	Sleeve size	Fits 27" sleeves	Fits 26" sleeves and sleeves as small as 24 1/2"
	Applications	RESIDENTIAL OR LIGHT COMMERCIAL	RESIDENTIAL OR LIGHT COMMERCIAL
COMFORT & CONVENIENCE	Perfect fit for Fedder's 27" sleeves	Y	—
	Top mounted controls	Y	—
	Electronic controls	Y	Y
	Programmable timer	24 hr.	12 hr.
	Remote control	Y	Y
	Auto restart when power is interrupted	Y	Y
	Smart Fan auto adjusting fan	Y	—
	Upward angled air discharge	Y	—
	Air flow direction control	4-way	6-way
Fan speeds	3	3	
SOUND REDUCTION TECHNOLOGY	Steel inner wall and extra dense insulation	Y	Steel inner wall
	Vibration isolating design and components	Y	Y
	Superior airflow design	Y	—
EARTH FRIENDLY	ENERGY STAR® models	Y	Y
	Environmentally friendly R-410A	Y	Y
	Energy saver switch	Y	Y
HEALTH	Washable, antimicrobial air filter	Y	Y
	Stale air exhaust	—	Y
SAFETY	EntryGard™ anti-intrusion protection	Y	—
	Insect barrier	Y	—
INSTALLATION	Slideout chassis	Y	Y
	Power cord direction	Left	Right
	Concealed power cord option	Y	—
	Internal drain kit option	Y	—
	Baffle adapter kit	Y	Y
	Condensate drain kit	Y	—

# THRU-THE-WALL AIR CONDITIONERS

## THE BEST OPTION FOR DEEP WALL INSTALLATIONS

Energy efficient solid-side air conditioners, heat pumps and electric heat models.

NEW CONSTRUCTION  
REMODEL & RETROFIT



## WALLMASTER®. A PERFECT FIT IN FRIEDRICH AND EXISTING 27" SLEEVES.

Commercial grade quality unit is ideal for installation in new construction, retrofits and remodels.

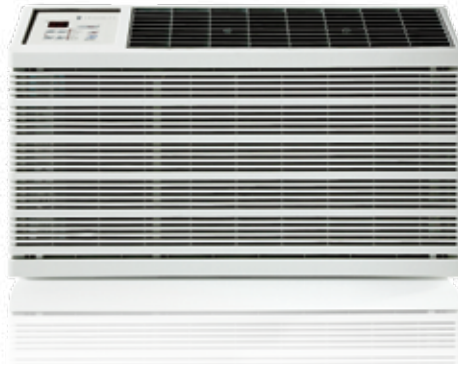

COMMERCIAL  
GRADE

FEDDERS  
RETROFIT

UNIVERSAL  
FIT

WallMaster®  
7800-15600 Btu  
Up to 9.9 EER

WallMaster®  
*Electric Heat*  
COOLING  
9200-15600 Btu  
Up to 9.6 EER  
ELECTRIC HEAT  
9100-11000 Btu

WallMaster®  
*Heat Pump*  
COOLING  
9000-12000 Btu  
Up to 9.4 EER  
HEATING  
7300-9350 Btu



Fits Fedders A & B sleeves. B sleeve installations require BAK accessory, baffle adapter kit.

### WSD Wall Sleeve

Ships with inner and outer weather panels, as well as standard grille. Optional architectural grille is available. See accessories page for full description.



WSD sleeve with standard grille.



WSD sleeve with architectural grille. Great for keeping out inclement weather.

NOTE: Chassis requires WSD sleeve for new installations (sold and shipped separately)

# WALLMASTER® FEATURES

## Comfort & Convenience

- Easy-to-reach, top mount controls
- Remote control
- 24-hour programmable timer
- Smart Fan auto-adjusts fan speed to maintain desired temperature
- 3-speed fan
- Auto restart
- Electronic defrost control
- Insect barrier
- Reversible louver allows a second airflow option

## Energy Management and Compliance

- Money Saver® setting saves money by operating the fan only when needed
- Six ENERGY STAR® models
- R-410A refrigerant

## Health and IAQ

- Washable, antimicrobial filter



Select MODE, FAN SPEED, or MONEYSAVER. Adjust TEMPERATURE and set the TIMER.

## Durability & Quality

- Rotary compressors provide quiet, dependable performance
- Premium aluminum exterior grille
- Dense blower insulation
- Rifled copper tubing
- Impact resistant front cover
- High tech fins with sine wave lanced louvers increase energy efficiency by increasing surface area for heat exchange



Rifled copper tubing



Sine wave lanced louvers

## Safety & Security

- EntryGard™ anti-intrusion protection-chassis secured to sleeve to deter 'kick-in' intrusion
- Power cord current leakage protected
- Insect barrier

## Maintenance and Installation Features

- Mounts flush with the exterior wall for a neat appearance
- Ideal for thicker wall installations, where side fins don't fit
- Reversible louver allows for a second airflow option
- A high efficiency replacement for 27" sleeves including Fedders A and B\*. Sleeve measures 27" W x 16 3/4" H

## Accessories

- WSD sleeve, ships with inside and outside weather panel and standard grille
- AG architectural grille for use with WSD sleeve
- Baffle adapter kit for use with deep sleeve installations
- Drain kit for condensate disposal
- Sub base used as unit base and/or to hide power cord
- Internal drain kit for new construction applications where condensate drain system is built-in

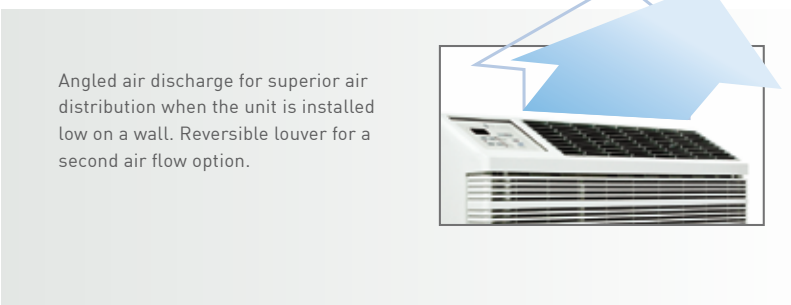

WallMaster® fits existing Fedders sleeves.

Sleeve Dimensions	Friedrich WSD Sleeve	Fedders A Sleeve	Fedders B Sleeve*
Height (inches)	16 3/4	16 3/4	16 3/4
Width (inches)	27	27	27
Depth (inches)	16 3/4	16 3/4	19 3/4

Chassis requires WSD sleeve (sold and shipped separately)

\*Installation in Fedders B sleeve requires a baffle kit. See BAK accessory under accessories.



RECYCLABLE PACKAGING



R-410A OZONE FRIENDLY REFRIGERANT



## UNI-FIT®

### UNIVERSAL FIT THRU-THE-WALL FOR EASY REPLACEMENT IN EXISTING 24 1/2", 26" OR 27" SLEEVES.

**Residential grade quality for installation in new construction, retrofits and remodels.**

THICKER WALLS

COMMERCIAL GRADE

UNIVERSAL FIT

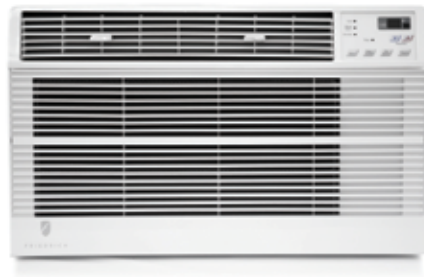

#### P R E L I M I N A R Y

Uni-Fit®  
8000-13000 Btu  
Up to 9.6 EER

Uni-Fit®  
*Electric Heat*

COOLING  
8000-11500 Btu  
Up to 9.4 EER  
ELECTRIC HEAT  
3850-11200 Btu

#### US Wall Sleeve

Ships with standard grille. A replacement grille is included with the chassis for use on existing sleeves. See accessories page for full description.



US sleeve with standard grille.



US sleeve with replacement grille.

NOTE: Chassis requires US sleeve for new installations (sold and shipped separately)

### Comfort & Convenience

- 6-way air flow control
- Remote control
- 24-hour programmable timer
- 3-speed fan
- Auto restart
- Defrost control

### Energy Management and Compliance

- Money Saver® setting saves money by conserving energy
- Five ENERGY STAR® models
- R-410A refrigerant

### Health and IAQ

- Washable antimicrobial filter
- Stale air exhaust



Select MODE, FAN SPEED, adjust TEMPERATURE and set the TIMER.

### Durability & Quality

- Rotary compressors provide quiet, dependable performance
- Seacoast protection for corrosion resistance in harsh environments

### Installation and Maintenance Features

- Universal fit trim ring
- Sleeve designed to fit a standard 26" opening and sleeves as small as 24 1/2"



### Accessories

- USD sleeve ships with expanded aluminum grille
- Replacement grille ships with US/UE chassis for use in existing sleeves when a grille is needed

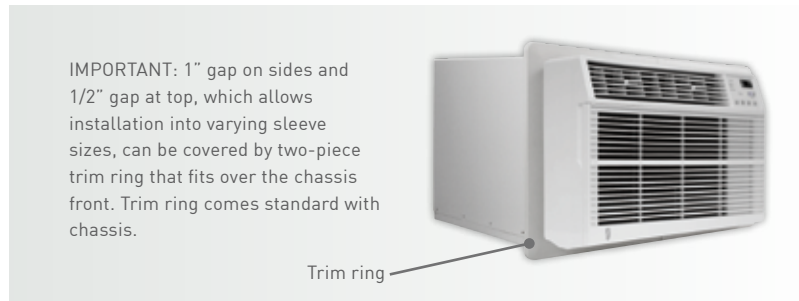

IMPORTANT: 1" gap on sides and 1/2" gap at top, which allows installation into varying sleeve sizes, can be covered by two-piece trim ring that fits over the chassis front. Trim ring comes standard with chassis.

Uni-Fit® installs in many existing sleeves.

Sleeve Dimensions	Friedrich USC Sleeve	Amana	Carrier (51S Series)	Fedders/ Emerson/ Friedrich WSD	Emerson/ Fedders	GE/ Hot-point	Whirlpool	White-Westingshouse/ Frigidaire/ Carrier (52F Series)
Height (inches)	15 1/2	15 5/8	16 7/8	16 3/4	15 3/4	15 5/8	16 1/2	15 1/4
Width (inches)	25 7/8	26	25 3/4	27	26 3/4	26	25 7/8	25 1/2
Depth (inches)	16 3/4	16 7/8	18 5/8	16 3/4 or 19 3/4	15	16 7/8	17 1/8 or 23	16, 17 1/2 or 22

NOTE: Chassis requires US sleeve for new installations (sold and shipped separately)



RECYCLABLE PACKAGING



R-410A OZONE FRIENDLY REFRIGERANT





# THRU-THE-WALL ACCESSORIES

## WallMaster® 27" Sleeve Exterior Grilles



**WSD Sleeve Standard Grille**  
Premium, stamped galvanized steel grille with powder coat paint. Ships with sleeve. Galvanized steel inner and outer weather panels also ship with sleeve.



**WSD Sleeve Optional Architectural Grille- AG**

**IMPORTANT:**  
Operating the air conditioner with incorrect rear grille or without Baffle Adapter Kit (on 19 3/4" deep sleeve) will recirculate discharge air and cause compressor overload to trip. This will cause the unit to shut down temporarily and may lead to premature compressor failure.

### CORRECT Vertical Louvers

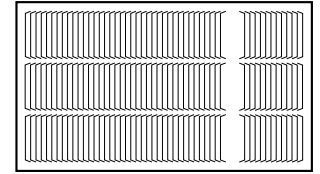

### INCORRECT Horizontal Louvers

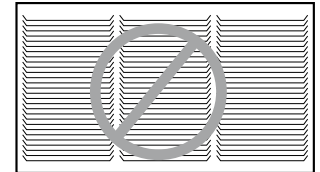

## Installation Accessories (27" sleeve models only)

**DK / Drain Kit**  
Installed at the back of the unit and allows for attachment to condensate disposal system, if necessary or desired.

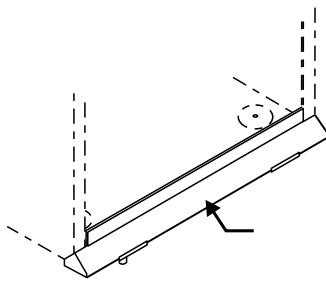

**SB / Sub Base (Hides power cord)**  
Used as a base for the unit when it is desired to place the cord and receptacle within the installation, or simply as a base for the unit when mounted low in the wall or in walls less than 6 inches deep.

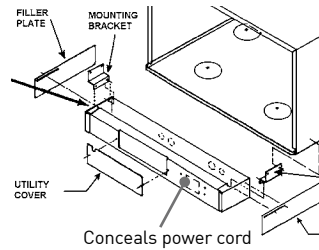

**IDK / Internal Drain Kit**  
New construction applications where a condensate drain system has been built into the wall interior.

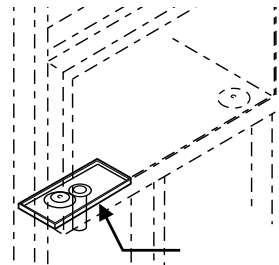

**BAK / Baffle Adapter Kit**  
Necessary when installing in a sleeve deeper than 16 3/4" deep, such as Fedders B sleeve (19 3/4" deep).

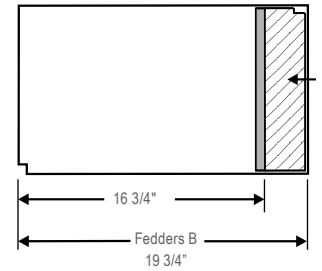

## Uni-Fit® 26" Sleeve Exterior Grilles



USC Sleeve Standard Grille



Sleeve shown with Replacement Grille

**STANDARD GRILLE** – Ships with USC sleeve  
Expanded aluminum grille designed for use with USC sleeve.

**REPLACEMENT GRILLE** – Ships with US/UE chassis  
Black plastic for use on existing sleeves without any grille.

**IMPORTANT:**  
When installing into an existing sleeve, consult installation section of your Installation/Operation Manual to determine whether or not the grille needs to be replaced and/or a baffle adapter should be used.

## Sleeve/Chassis Dimensions

Model	Sleeve			Depth with Front	Minimum Extension Into Room	Minimum Extension Outside	Thru-the-wall Finished Hole		
	Height	Width	Depth				Height	Width	Max. Depth
<b>WallMaster®</b>									
WSD Sleeve	16 3/4"	27"	16 3/4"	23"	7 1/2"	9/16"	17 1/4"	27 1/4"	15 5/16"
Chassis	15 3/4"	26 1/2"	21"	22"	-	-	-	-	-
<b>Uni-Fit®</b>									
USC Sleeve	15 1/2"	25 7/8"	16 3/4"	20 1/2"	-	1/2"	15 3/4"	26 1/8"	16 1/4"
US Chassis	14 3/8"	24"	18 1/2"	20 1/8"	3 3/4"	-	-	-	-
UE Chassis	14 3/8"	24 5/8"	18"	19 5/8"	3 1/2"	-	-	-	-

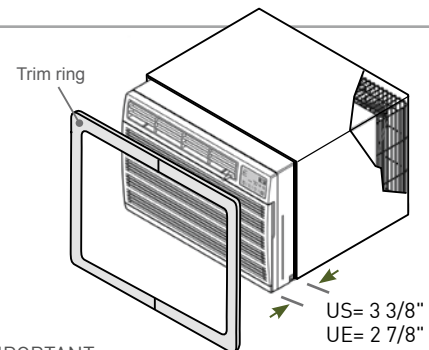

**IMPORTANT:**  
US chassis w/front fully installed into USC sleeve extends into room 3 3/8". UE chassis w/front fully installed into USC sleeve extends into room 2 7/8". 1" gap on sides and 1/2" gap at top can be covered by two-piece trim ring that fits over the chassis front.



# THRU-THE-WALL SPECIFICATIONS

## P R E L I M I N A R Y

★ ENERGY STAR® models

Model	Cooling Capacity Btu	Heating Capacity Btu	Volts Rated	Cooling Amps	Cooling Watts	Heating Amps	Heating Watts	Energy Efficiency Ratio EER	Estimated Yearly Operating Cost	Moisture Removal Pints/HR	CFM	Sleeve	Net Weight Lbs
<b>WallMaster®</b>													
<i>Cool only</i>													
★ WS08C10	7800	NA	115	7.1	788	NA	NA	9.9	†	1.2	250	WSD	93
★ WS10C10	9700	NA	115	10.0	1032	NA	NA	9.4	\$82	2.4	257	WSD	103
★ WS12C10	11900	NA	115	11.8	1266	NA	NA	9.4	\$101	3.3	295	WSD	112
★ WS10C30	9500/9200	NA	230/208	4.5/4.7	989/958	NA	NA	9.6/9.6	\$79	1.5	300	WSD	101
★ WS13C30	12600/12300	NA	230/208	6.3/6.7	1340/1309	NA	NA	9.4/9.4	\$107	3.6	290	WSD	109
WS16C30	15600/15000	NA	230/208	8.0/8.5	1835/1765	NA	NA	8.5/8.5	\$144	4.2	290	WSD	119
<i>Heat Pump</i>													
★ WY09C33	9300/9000	7300/7300	230/208	4.4/4.7	989/957	3.8/4.0	839/793	9.4/9.4	\$79	2.1	250	WSD	103
WY12C33	12000/11800	9350/9200	230/208	6.1/6.4	1395/1372	4.8/5.1	1062/1010	8.6/8.6	\$111	2.6	275	WSD	111
<i>Cool with Electric Heat</i>													
WE10C33	9500/9200	11000/9100	230/208	4.5/4.7	989/957	16.0/14.7	3550/2950	9.6/9.6	\$79	1.5	300	WSD	121
WE13C33	12600/12300	11000/9100	230/208	6.3/6.7	1340/1309	16.0/14.7	3550/2950	9.4/9.4	\$107	3.6	290	WSD	107
WE16C33	15600/15000	11000/9100	230/208	8.0/8.5	1835/1765	16.0/14.7	3550/2950	8.5/8.5	\$144	4.2	290	WSD	119
<b>Uni-Fit®</b>													
<i>Cool Only</i>													
★ US08D10	8000	-	115	7.5	830	-	-	9.6	\$66	2.2	260	USC	73
★ US10D10	9800	-	115	9.0	1040	-	-	9.4	\$83	3.2	285	USC	78
★ US12D10	11500	-	115	10.6	1220	-	-	9.4	\$97	3.8	290	USC	80
★ US10D30	10000/9800	-	230/208	4.7/5.2	1060/1040	-	-	9.4/9.4	\$85	3.2	285	USC	78
★ US12D30	11500/11200	-	230/208	5.3/5.7	1220/1190	-	-	9.4/9.4	\$97	3.8	290	USC	80
US14D30	13000/12600	-	230/208	7.0/7.5	1530/1480	-	-	8.5/8.5	\$122	4.0	310	USC	87
<i>Cool with Electric Heat</i>													
UE08D11	8000	3850	115	7.5	830	13.0	1500	9.4	\$66	2.2	260	USC	73
UE10D33	10000/9800	11200/9200	230/208	4.7/5.2	1060/1040	15.3/14.0	3500/2900	9.4/9.4	\$85	3.2	285	USC	78
UE12D33	11500/11200	11200/9200	230/208	5.3/5.7	1220/1190	15.3/14.0	3500/2900	9.4/9.4	\$97	3.8	290	USC	80

WallMaster Heat Pump heating information (shown in red) indicates heat pump heating performance. WallMaster Electric Heat heating information (shown in red) indicates electric heat strip performance. For WallMaster Heat Pump electric heating performance refer to corresponding WallMaster Electric Heat model.

### WALLMASTER HEAT PUMP

**HEATING PERFORMANCE:** Change-over from heat pump operation to resistance operation on models indicated is automatic at a preset outside ambient temperature of approximately 35°F.



Calculate the heat loss of the space to be heated. As long as the heat loss does not exceed the resistance heating capacity rating of the unit, the heating performance will be satisfactory.

Note: all models will produce condensate. If condensate disposal is desired, an optional drain kit is available.

**DEFROST CONTROL:** Initiated at 30°F (outdoor coil temperature) and terminated at 43°F (outdoor coil temperature). During defrost, the compressor stops and the electric heat starts, then operates with the fan to maintain indoor comfort. Below 43°F, the unit remains in electric heat mode.

**DEFROST DRAIN:** Drain automatically opens at approximately 50°F to prevent condensate from freezing inside drain pan.

### Plug Face/ Circuit Rating

WallMaster® Model Number	Uni-Fit® Model Number	Circuit Rating Breaker or T-D Fuse	Plug Face (NEMA#)	Power Cord Length (ft.)	Wall Outlet Appearance
WS08C10, WS10C10, WS12C10	US08D10, UE08D11 US10D10, US12D10	125V - 15A	5 - 15P	6	
WS10C30, WS13C30, WS16C30	US10D30, US12D30, US14D30	250V - 15A	6 - 15P	4	
WE10C33, WE13C33, WE16C33, WY09C33, WY12C33	UE10D33, UE12D33	250V - 20A	6 - 20P	4	

Power cords are located on front left of WallMaster models and on front right of Uni-Fit models.

Due to continuing research in new energy-saving technology, specifications are subject to change without notice. As an ENERGY STAR® partner, Friedrich Air Conditioning Co. has determined that the selected ENERGY STAR® models meet the ENERGY STAR® guidelines for energy efficiency.

Estimated yearly operating cost based on a 2007 national average electricity cost of 10.65 cents per kWh.

† The estimated yearly operating cost of this model was not available at the time the range was published.



R-410A  
OZONE FRIENDLY  
REFRIGERANT



## DUAL-HOSE DESIGN FOR UP TO 40% FASTER COOLING

Self-evaporative condensate system, so there's no bucket to empty.

Removes up to 72 pts./day when used as a dehumidifier.

3-in-1 system: Air conditioner, dehumidifier and fan.



ZoneAire®

Cool only  
9300 and 11600 Btu  
Up to 9.4 EER

SELF  
EVAPORATIVE

NO BUCKET  
TO EMPTY

40% FASTER  
COOLING

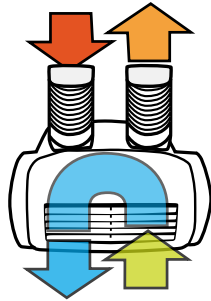

### DUAL HOSE

Only indoor air is conditioned and returned into the room. Indoor air is not vented outside and wasted.

The room is cooled up to 40% faster with greater energy efficiency.

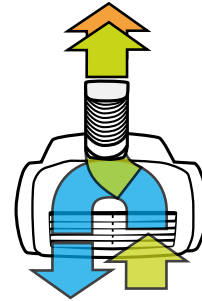

### SINGLE HOSE

Relies on air 'leakage' around doors and windows to make up for air volume lost as indoor air is exhausted outside.

Inefficient—both indoor air and removed heat are exhausted.



NOTE: Unit not shown installed. Vent hoses must vent outdoors.

# COOLING PLUS ENERGY-EFFICIENT HEATING IN WINTER

ZoneAire® heat pump operation is more efficient than other portables that rely on resistance heat.

4-in-1 system:  
Air conditioner,  
heater,  
dehumidifier and  
fan.



## ZoneAire®

Heat pump  
13500 Btu-COOLING  
10700 Btu-HEATING  
9.5 EER



USE REMOTE TO SELECT MODE, FAN SPEED, ADJUST TEMPERATURE AND SET THE TIMER.

## Comfort & Convenience

### HEAT PUMP

- 4-IN-1 SYSTEM: Air conditioner, heater, dehumidifier and fan
- Built-in drain pump to remove condensate in heating mode
- Condensate overflow protection- the unit will automatically shut off if tank should become full. The unit can be drained through the water outlet drain

### AIR CONDITIONERS

- 3-IN-1 SYSTEM: Air conditioner, dehumidifier and fan
- Dual hoses for closed loop cooling and exhaust functions for up to 40% faster, more efficient cooling
- Self-evaporative condensate system means no bucket to empty
- 24-hour timer
- 3 fan speeds
- Washable, antimicrobial air filter
- Auto restart after power outage
- Stores easily in most closets



Be ready for cooling emergencies



RECYCLABLE  
PACKAGING



R-410A  
OZONE FRIENDLY  
REFRIGERANT

# SPECIFICATIONS/INSTALLATION

## Ideal Applications

- Workshops and garages
- Home offices
- Dorm rooms
- Bedrooms, attics and basements
- Sunrooms/enclosed patios
- Supplemental or emergency cooling/heating

## Installation Features

- Plugs into standard 115 volt outlet
- Easy-roll casters for portability
- All installation accessories included
- Window kit fits both vertical and horizontal window openings
- 6 ft. long power cord

## Installation Kit

INSTALLATION KIT- Dual intake and exhaust hoses. Flexible, heavy duty intake/exhaust hoses extend from 24" to 60". The hoses can be vented through a window or through a wall opening to the outside.

WINDOW SLIDER KIT (Included)



Fits HORIZONTAL or VERTICAL WINDOWS  
WINDOW OPENING:  
Minimum: 26"\* Maximum: 46"

\* Window slider kit can be trimmed to fit a smaller opening.

Model		P09B	P12B	PH14B
<b>PERFORMANCE</b>				
Cooling Capacity	Btu	9300	11600	13500
Heating Capacity	Btu	—	—	10700
Energy Efficiency Rating	EER	9.4	8.8	9.5
Air Movement	CFM	212	235	250
Moisture Removal	Pts/hr.	5.0	6.0	6.0
<b>SPECIFICATIONS</b>				
Refrigerant Type		R410A		
Power Supply	Volts	115		
Rated Current	Amps	10.8	11.5	10.8
Dimensions (Inches)	W	19 1/2		
	H	33 1/2		
	D	15 1/2		
Weight (Net/Shipping)	Lbs.	71/89	72/90	78/95

Model	Circuit Rating Breaker or T-D Fuse	Plug Face (NEMA#)	Wall Outlet Appearance	Power cord length
P09B, P12B, PH14B	125V - 15A	5 - 15P		6 ft.

Due to continuing research in new energy-saving technology, specifications are subject to change without notice.



R-410A  
OZONE FRIENDLY  
REFRIGERANT



# HAZARDOUS LOCATION ROOM AIR CONDITIONERS

HAZARDGARD®. UL APPROVED FOR USE IN CLASS 1, DIVISION 2, GROUPS A, B, C AND D HAZARDOUS LOCATIONS.

Operates at low ambient conditions without freezing at outdoor ambient temperatures as low as 45° F/7° C.

Tolerates higher outdoor temperatures up to 130° F/55° C.

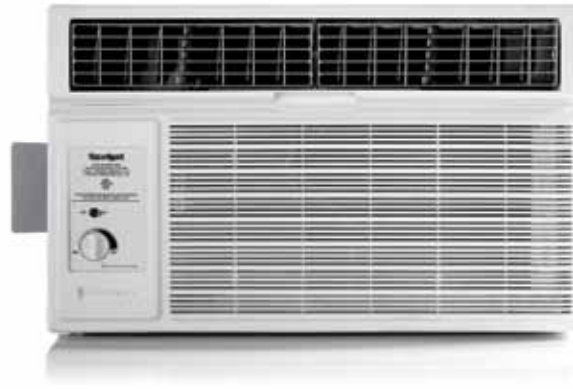

Hazardgard®  
60 Hertz  
North America  
14500 and 19500 Btu  
Up to 9.7 EER

Hazardgard®  
50 Hertz  
International  
19500 Btu  
9.0 EER



## Hazardgard®

Hazardgard is specifically designed to cool living quarters, storage areas and other enclosures situated in hazardous locations, where specific volatile flammable liquids or gases are handled or used within enclosed containers or systems.

For more than 30 years, Hazardgard has endured some of the toughest and most unforgiving operating conditions imaginable. Time-tested in the field where it counts, Hazardgard is trusted by professionals who have to get the job done.

Robust engineering with design details like 33% thicker fins extend the life of the coil. Diamonblue advanced corrosion protection treatment provides added endurance and protection in coastal or corrosive environments. Totally enclosed, heavy-duty motors have a hermetically sealed overload for arc-free operation.



# FEATURES

## Durability

- Permanent split capacitor
- Hermetically sealed refrigeration system
- Environmentally sealed on/off switch and gold plated contacts in thermostat for corrosion resistance.
- Solid-state control relays for compressor and fan operation.
- Hot gas bypass allows the air conditioner to operate at low ambient conditions without freezing at outdoor ambient temperatures as low as 45° F.
- Hermetically sealed reciprocating compressor is cooled during the refrigeration cycle, which allows the unit to tolerate higher outdoor temperatures up to 130° F.
- Larger, commercial grade, enclosed fan motor with hermetically sealed overload for arc-free operation. Totally enclosed to assure efficient operation under adverse electrical conditions.
- Unit utilizes direct-wired, 15-amp circuit with time-delay fuse that will tolerate current surge without tripping the breaker.
- 20-gauge steel is used in order to create a more robust air conditioner cabinet that will withstand years of hard use.
- Diamonblue Advanced Corrosion Protection™ provides added endurance and protection in coastal or corrosive environments.



**DIAMONBLUE**  
Advanced Corrosion Protection™



# APPLICATIONS

## Built to perform in the harshest environments

- Offshore oil rigs, on-shore oil company offices and refineries
- Petrochemical sites and propane fill-up stations
- Paint and varnish storage or processing plants
- Grain alcohol processors or storage sites
- Plant areas using strong solvents or chemicals
- Munitions plants or armories
- PVC or plastics plants and processing points
- Recycling plants
- Furniture refinishing/stripping workshops
- Fertilizer plants
- Office complexes where methane is a by-product
- Hazardous materials storage

Hazardgard also meets the U.S. National Electric Code, Article 500 requirements for Class 1, Division 2, Groups A, B, C and D Hazardous locations.



## Built tough

Friedrich air conditioners can be found in some of the world's toughest locations. Oil companies rely on us to cool offshore oil rigs in the most extreme conditions, and military bases and government offices all over the world choose Friedrich. Industrial and high tech leaders also trust Friedrich commercial grade products for their applications.



# SPECIFICATIONS

## Specifications

Model	Electrical Characteristics				Energy Efficiency Ratio EER	Moisture Removal Pints/HR	Air Direction Controls	CFM	Refrigerant
	Cooling Capacity		Cooling Amps	Cooling Watts					
	Btu	Volts Rated							
<b>60 HERTZ - NORTH AMERICA</b>									
SH15M30	14500/14000	230/208	6.9/7.5	1495/1443	9.7/9.7	6.0	8-way	375	R-410A
SH20M30	19500/19000	230/208	8.7/9.6	2074/2021	9.4/9.4	4.0	8-way	425	R-410A
<b>50 HERTZ - INTERNATIONAL</b>									
SH20M50	19500/19400	240/220	9.8/10.3	2167/2156	9.0/9.0	5.6/5.5	8-way	425	R-410A

## Installation Information

Model	Dimensions INCHES						Window Width INCHES		In-Wall Installation Finished Hole INCHES			Circuit Rating Breaker or T - D Fuse		Weight Lbs.	
	Height	Width	Depth with Front	Depth J Box to Louvers	Minimum Extension Into Room	Minimum Extension Outside	Min.	Max.	Height	Width	Max. Depth	Volts - Amps	Net	Shipping	
			A	B											C
SH15M30	15 15/16"	25 15/16"	27 3/8"	6"	3 1/16"	16 15/16"	27 7/8"	42"	16 3/16"	26 3/16"	6"	250V - 15A	140	167	
SH20M30	17 15/16"	25 15/16"	27 3/8"	6"	3 1/16"	16 15/16"	27 7/8"	42"	18 3/16"	26 3/16"	6"	250V - 15A	166	170	
SH20M50	17 15/16"	25 15/16"	27 3/8"	6"	3 1/16"	16 15/16"	27 7/8"	42"	18 3/16"	26 3/16"	6"	250V - 15A	171	175	

Due to continuing engineering research and technology, specifications are subject to change without notice. Manufactured under U.S. Design Patent DES 368, 306 decorative front; Utility Patent 5, 622, 058. MAXIMUM outdoor ambient operating temperature is 130°F. MAXIMUM TEMPERATURE RATING FOR CLASS I, DIVISION 2, GROUPS A,B,C,D.

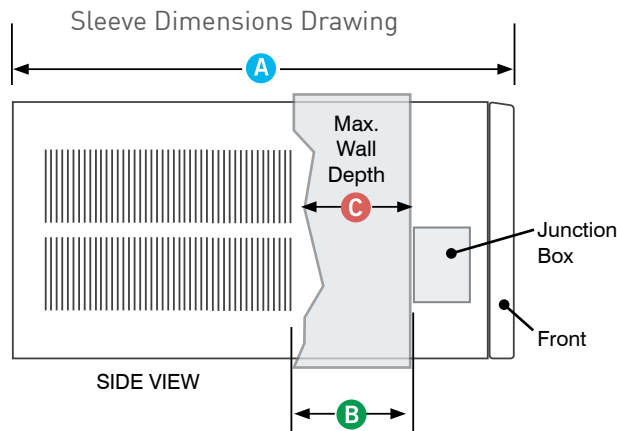

NOTE: Hazardgard unit must be hard-wired.





Friedrich is a partner in the ENERGY STAR® program which promotes the conservation of energy and the protection of the environment through the purchase of high efficiency appliances.



**F R I E D R I C H**

Friedrich Air Conditioning Co. | 10001 Reunion Place, Suite 500 | San Antonio, TX 78216 | 800.541.6645 | [www.friedrich.com](http://www.friedrich.com)