

GTWN5250D GE® 3.9 DOE cu. ft. stainless steel capacity washer

Dimensions and Installation Information (in inches)

Circuit Requirements: An individual, properly-grounded branch circuit, with a three-prong grounding-type receptacle, protected by a 15 or 20 amp circuit breaker or a time-delay fuse, is required.

Electrical Rating: 120V, 60Hz, 10A

Note: Washer wall outlet must be located within 36" of service code entry. Wall outlet must not be located behind dryer.

Installation Information: Before installing, consult installation instructions packed with product for current dimensional data.

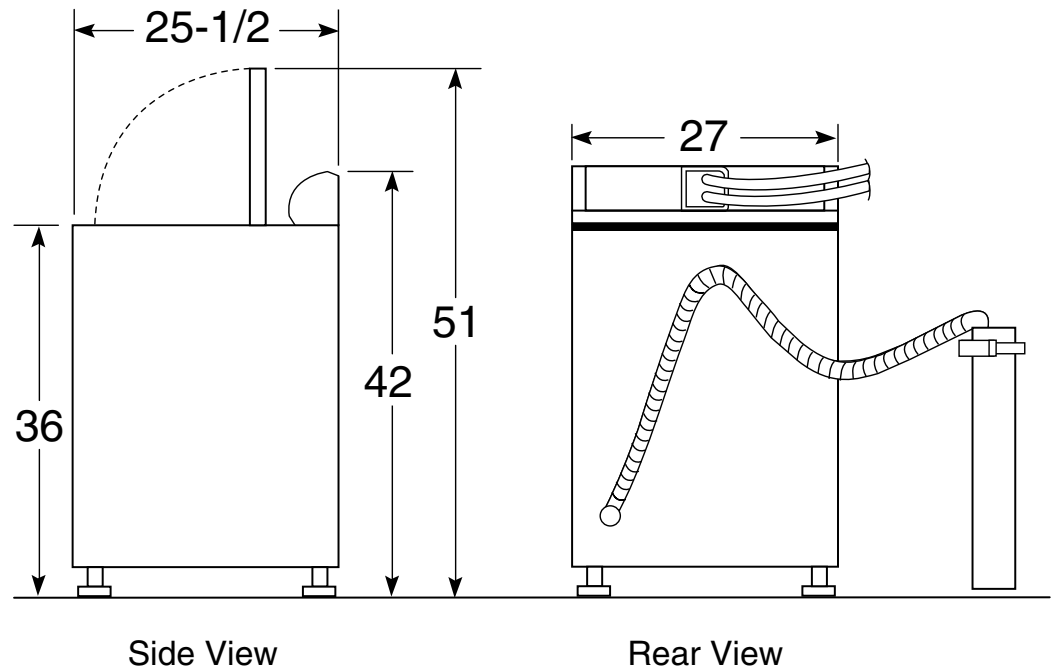

For answers to your Monogram®, GE Profile™ or GE® appliance questions, visit our website at geappliances.com or call GE Answer Center® service, 800.626.2000.



GTWN5250D

GE® 3.6 DOE cu. ft. stainless steel capacity washer

Features and Benefits

- ENERGY STAR® qualified —meets or exceeds federal guidelines for energy efficiency for year-round energy and money savings
- HydroWave® Quiet Agitator wash system—longer, slower travel provides gentle, thorough cleaning
- Rotary electronic controls with cycle status lights provide accurate cycle times
- 10 wash cycles handle various fabrics and soils
- PreciseFill with the option of 4 water level selections will automatically measure the load size and add just the right amount of water
- Bleach and fabric softener dispensers automatically operate with wash cycle
- 700-RPM spin speed—fast spin speeds remove water efficiently and minimize dry times
- Model GTWN5250DWW – White

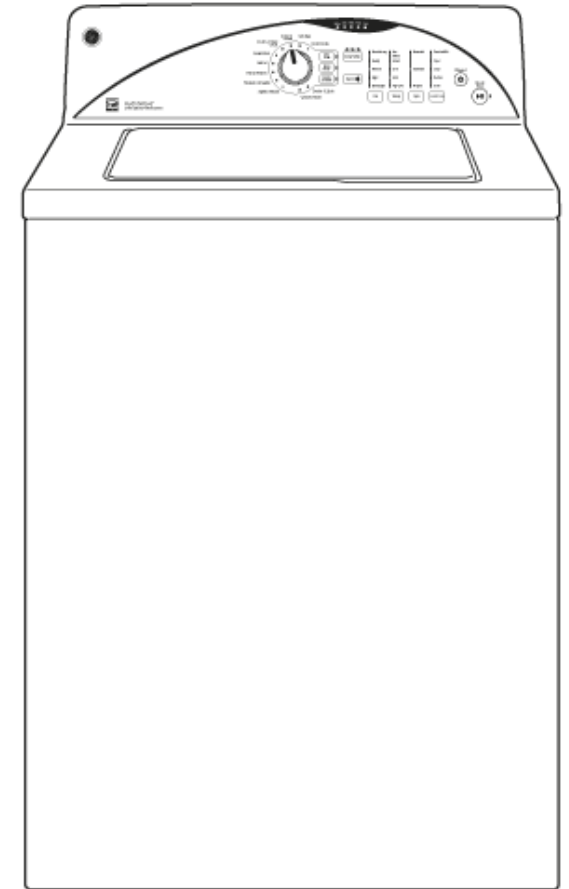

Modified Energy Factor (MEF)	2.20
Water Factor (WF)	4.50



imagination at work

