

Space Saving 120 Volt

# Electric Vented Tumble Dryer

Wall-mountable

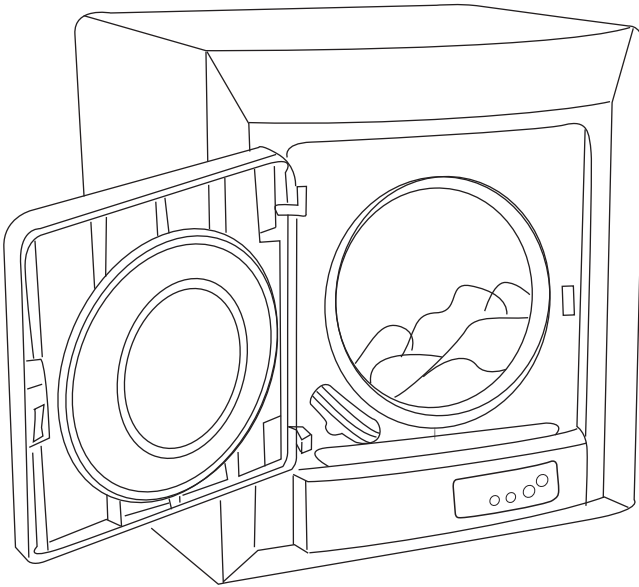

## Dryer User's Manual

HLP140E

- Please read this manual carefully before using.
- Retain it for future reference.

**Haier**

Quality Innovation Style

# UNPACKING DRYER



## Unpacking Your Dryer

1. Inspect and remove all packing materials. This includes the foam and any adhesive tape both inside and outside of the unit.
2. Inspect and remove any remains of packing, tape or printed materials before powering on the dryer.

# DANGER

### Risk of child entrapment.

**Before you throw away your old dryer, take off the door so that children may not easily get trapped inside.**

## PRODUCT REGISTRATION

Thank you for using our Haier product. This easy-to-use manual will guide you in getting the best use of your dryer.

Remember to record the model and serial number. They are on a label in back of the dryer.

\_\_\_\_\_ *Model number*

\_\_\_\_\_ *Serial number*

\_\_\_\_\_ *Date of purchase*

Staple your receipt to your manual. You will need it to obtain warranty service.

Please register online at [www.prodregister.com/Haier](http://www.prodregister.com/Haier)

# WARNING



As dry cleaning solvents, gasoline, vegetable and cooking oil are highly hazardous materials, items soaked in or spotted with such should not be used in the dryer. Items may still contain a substantial amount of the hazardous material after being washed. When such items are exposed to heat they could ignite. As clothes are stacked and piled up the dryer the heat cannot escape. Due to this, items become hot enough to possibly ignite. Washing in hot water with extra detergent would reduce but not eliminate the risk of fire.

# SAFETY INSTRUCTIONS

## **WARNING**

***To reduce the risk of fire, electric shock, or injury to persons when using your appliance, follow basic precautions, including the following:***

1. Read all instructions before using the appliance.
2. Do not dry articles that have been previously cleaned in, washed in, soaked in, or spotted with gasoline, dry-cleaning solvents, or other flammable or explosive substances, as they give off vapors that could ignite or explode.
3. Do not allow children to play on or in the appliance. Close supervision of children is necessary when the appliance is used near children.
4. Before the appliance is removed from service or discarded, remove the door to the drying compartment.
5. Do not reach into the appliance if the drum is moving.
6. Do not install or store this appliance where it will be exposed to water and/or to the weather.
7. Do not tamper with controls.
8. Do not repair or replace any part of the appliance or attempt any servicing unless specifically recommended in the user-maintenance instructions or in published user-repair instructions that you understand and have skills to carry out.
9. Do not use fabric softeners or products to eliminate static unless recommended by the manufacturer of the fabric softener or product.
10. Do not use heat to dry articles containing foam rubber or similarly textured rubber-like materials.
11. Clean lint screen before or after each load. **DO NOT OPERATE THE DRYER WITHOUT THE LINT FILTER IN PLACE.**
12. Keep area around the exhaust opening and adjacent surrounding areas free from the accumulation of lint, dust and dirt.
13. The interior of the appliance and the exhaust duct should be cleaned periodically, preferably by qualified service personnel.
14. Do not place items exposed to cooking oils in your dryer. Items contaminated with cooking oils may contribute to a chemical reaction that could cause a load to catch fire.
15. If material has been used with any flammable liquids or solids it should not be used in the dryer until all traces of the flammable liquids and its fumes have been removed.
16. This dryer must be properly installed in accordance with the installation instructions before it is used. See grounding instructions in the installation section.
17. Proper grounding must be ensured to reduce the risk of electric shock and fire. Check with a qualified electrician or service personnel if you are in doubt as to whether the dryer is properly grounded.
18. Use the dryer only for its intended purpose, drying clothes.
19. Always disconnect dryer from electrical supply before attempting any service. Disconnect power cord by grasping the plug, not the cord.
20. Replace worn power cords and/or loose plugs.

**SAVE THESE INSTRUCTIONS**  
**HOUSEHOLD USE ONLY**

# SAFETY INSTRUCTIONS

## Electrical Requirements



### WARNINGS:

#### Grounding Instructions:

This appliance must be grounded. It is equipped with a 3-wire cord having a grounded plug. The plug must be plugged into an outlet which is properly installed and grounded.

**Warning!** Improper use of the grounded wire can result in the risk of electric shock. Consult a qualified electrician if necessary. Do not attempt to defeat this safety feature by modifying the plug. Avoid the use of an extension cord because it may overheat and cause a risk of fire. However, if it is necessary to use an extension cord:

- A. Use only 3-wire extension cord with 3-blade grounding plug.
- B. The marked rating of the extension cord must be equal to or greater than the rating of this appliance.

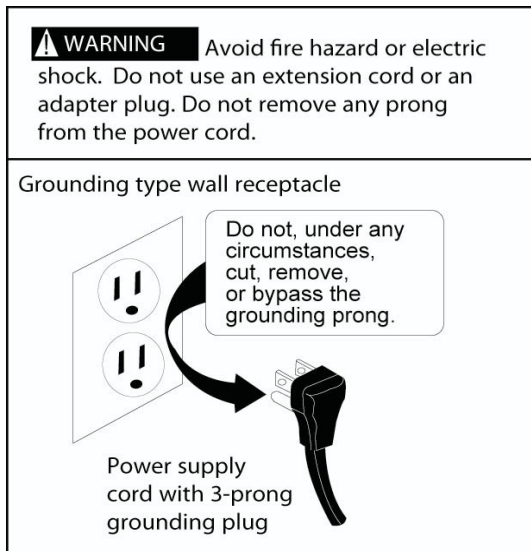

#### Attempting any maintenance or cleaning:

To minimize the possibility of electric shock, unplug this appliance from the power supply or disconnect the dryer at the household distribution panel by removing the fuse or switching off the circuit breaker before attempting any maintenance or cleaning (except the removal and cleaning of the lint filter).

#### Note

Pressing the Power ON/OFF button to an off position or pressing Start /PAUSE button, does **NOT** disconnect the appliance from the power supply.

# Table of Contents

Unpacking Your Dryer .....	1
Product Registration .....	1
Safety Instructions.....	2
Electrical Requirements .....	3
Parts and Features.....	5
<b>Set Up INSTRUCTIONS</b> .....	6-8
-Location of Your Dryer .....	6
-Assemble Dryer for Installation.....	7
-Venting the Dryer.....	8
<b>INSTALLATION INSTRUCTIONS</b> .....	9-11
-Wall Mounting Instructions.....	9-10
-Completing Installation .....	11
<b>OPERATING INSTRUCTIONS</b> .....	12-17
-Control Panel .....	12
- Quick Start.....	13-14
- Timed Dry.....	15
Drying Tips and Precautions .....	17
Care and Cleaning Guide .....	18
Troubleshooting .....	19
Limited Warranty .....	20-21

# Dryer Parts and Features

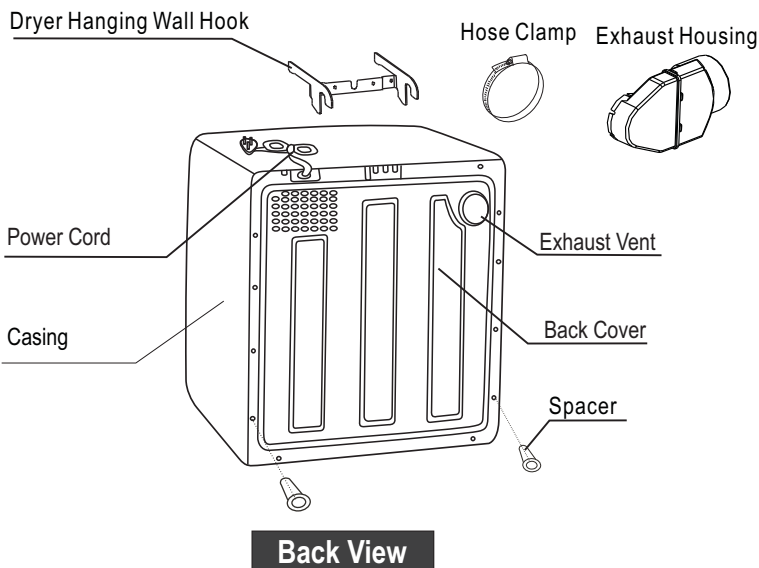
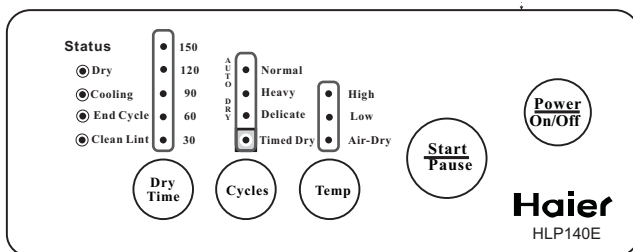
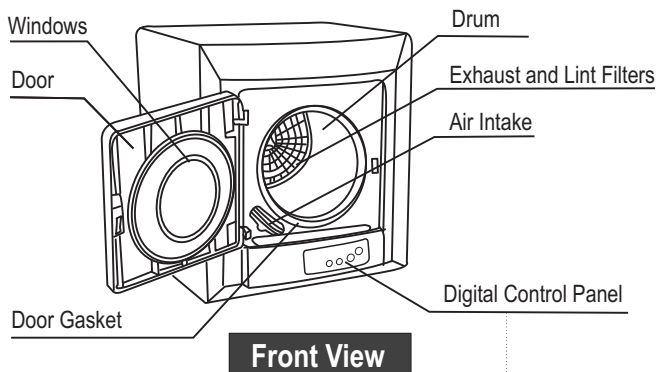

# SET UP INSTRUCTIONS

## Tools and Parts Required for Installation:

- Philips Head Screw Driver
- Flat Head Screw Driver
- Electric Drill and 1/8 inch drill bit
- Stud finder (optional)
- (6) Wood screws for mounting plywood
- Plywood board; size 30 (h) by 24(w) inches or wood slats

### Venting materials:

- 4 inch diameter metal exhaust rigid ducting and fittings or UL flexible metal dryer vent hose, that should not exceed 6 feet.
- 2 additional hose clamps for ducting outside exhaust vent hose
- Metal Elbows or outdoor vents as needed.

## Location of Your Dryer

First find a suitable location where you can mount the dryer on the wall and still have access to 120 Volt outlets and exterior venting.

### Vent to outside

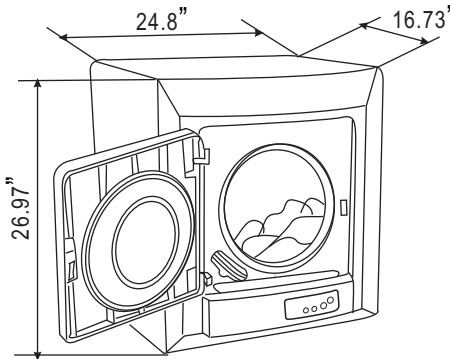
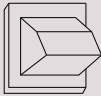

### Nearest 120 Volt AC outlet



Type: Electric dryer  
Rating: Please refer to the rating label regarding detailed information  
Size: 26.97x24.8x16.73(inch)  
Capacity: IEC2.6cu.ft.( 7.7 lb)  
Weight: 52.9lbs(24kg)

- Check dryer size and ensure a good location for the dryer installation on a wall where you can mount the unit using wall studs or beams.
- It is recommended to use a plywood board (30 by 24 inches) to mount the dryer using the walls beams and studs as support, rather than just wood slats.
- Make sure the dryer power cord can reach a 120 Volt outlet.
- Make sure you can connect the exhaust vent to the outside or designated dryer vent (in a laundry room).
- The length of exhaust ducting should not exceed 6 feet.
- Please read the additional ducting information and warnings in this manual.

# SET UP INSTRUCTIONS

## Assemble Dryer for Installation

Screw mounting hook bracket and wall spacer to dryer with screws provided.

1. Attach Hanging hook bracket using the 4 screws.

2. Attach the 2 wall spacers to the bottom of the dryer, using the 2 screws.

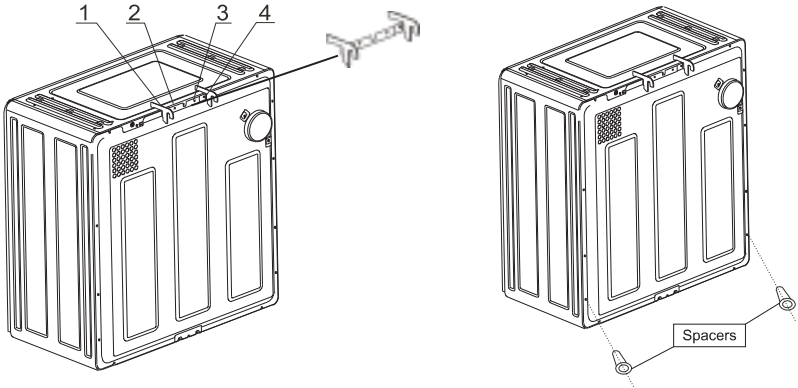

### 3. Attach Exhaust Housing

Connect vent housing to dryer using hose clamp provided to the exhaust pipe.

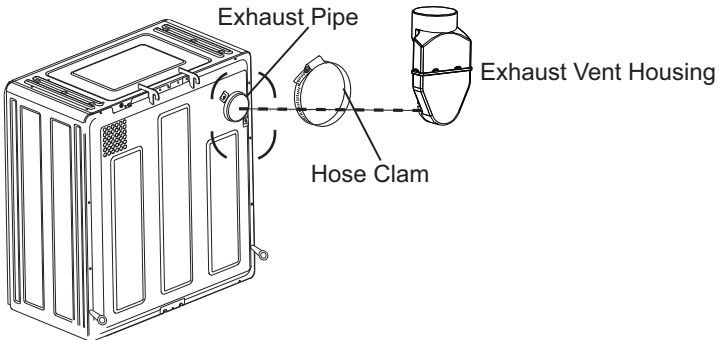

4. You have two choices of the exhaust pipe housing direction

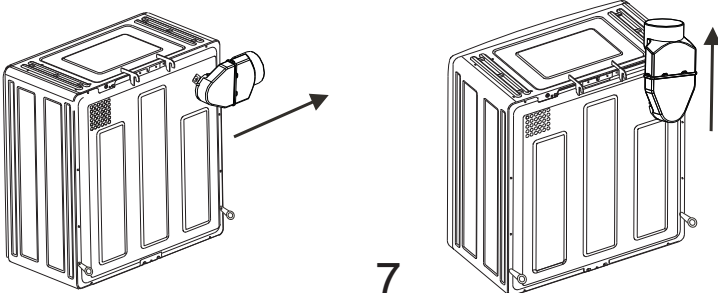



# SET UP INSTRUCTIONS

## 5. Venting The Dryer

Proper venting of the dryer is very important. Determine the best and safest ducting for the dryer.



### **WARNING!**

- Use a metal or UL vent.
- Do not use plastic ducting.
- Do not crimp or use excessive ducting.
- Clean old ducts before installing this dryer.

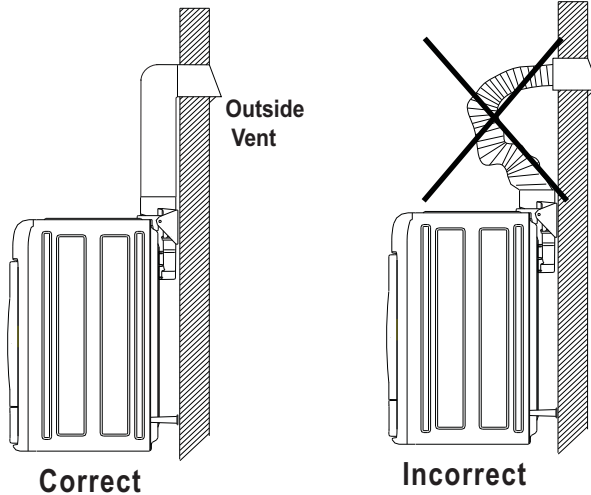

### **Exhaust Requirements and Maintenance.**

- Venting must conform to local building codes.
- Do not use thin plastic or foil ducting.
- Use 4 inches (10.2cm) diameter rigid or flexible metal duct (note: venting materials are not supplied with the dryer, and you should obtain the venting materials necessary for proper installation).
- Position the Dryer such that the exhaust duct run is as short as possible. **Make sure there is no more than 6 feet of exhaust ducting.**
- Clean old ducts before installing this dryer
- **Never bend or collapse ducting flex hose. Use few elbows joints as needed.**
- Use duct tape on all duct joints.
- Insulate ductwork that runs through unheated areas in order to reduce condensation and lint build-up on pipe walls.



### **WARNING**

**To reduce the risk of fire and combustion, the dryer must be vented outdoors.  
Lint accumulation can cause fires.**

Check and clean vents and ducting as often as possible.

**PLEASE BE AWARE THAT FAILURE TO EXHAUST THE DRYER  
CORRECTLY WILL VOID THE DRYER'S WARRANTY.**

# INSTALLATION INSTRUCTIONS

## Wall Mounting Instructions

### Location for installation and options for various walls

1. There are 2 mounting options- either using wood slats or a whole plywood board. The dryer installation to the wall should be able to accommodate the weight of the unit of 52 lbs. plus about 10 lbs. for clothing (or approximately 62 lbs). We suggest you use a plywood board for added support and safety, this is the best way to mount.

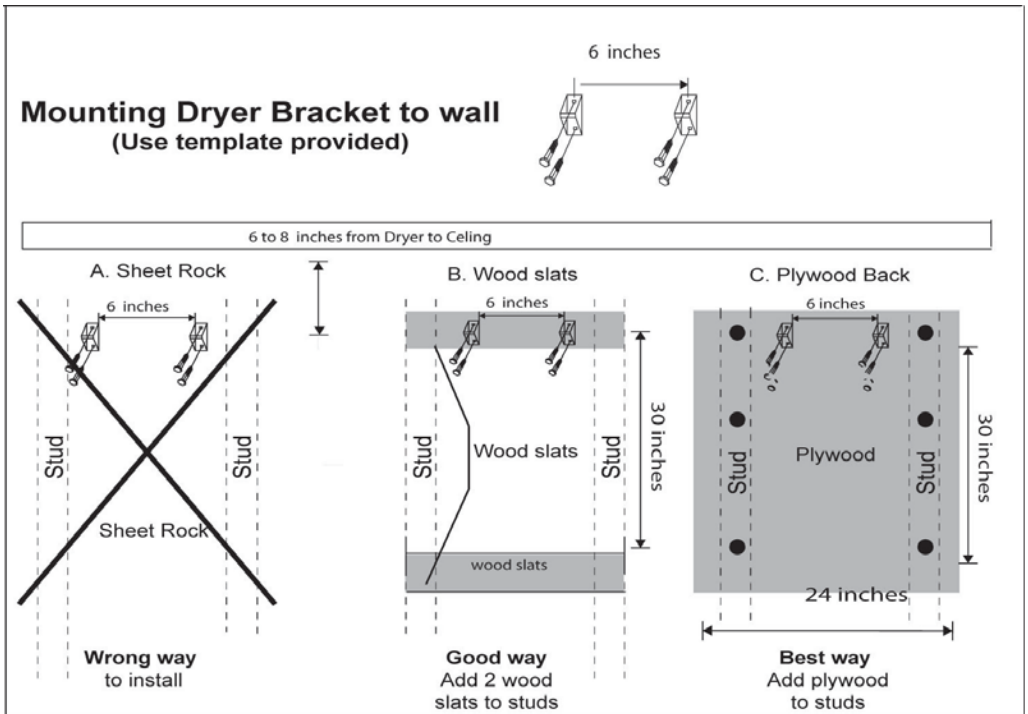

2. Determine dryer position on the wall. A minimum of 6" (Inches) is needed between the top of the dryer and the ceiling for installation.

3. If mounting the dryer above a washing machine, allow sufficient space to open the top lid of the washer.

4. The Best installation is to add a plywood board to the wall studs. As a second option- you can use two (2) slats (2 by 4 ") and attach to studs.

# INSTALLATION INSTRUCTIONS

## Mounting Plywood to wall

5. For the best installation:

Locate the wall studs in order to securely mount the unit on the wall. Use 1 plywood board size 30 (h) by 24(w) inches and mount into the wall studs using (6) wood screws (not provided)

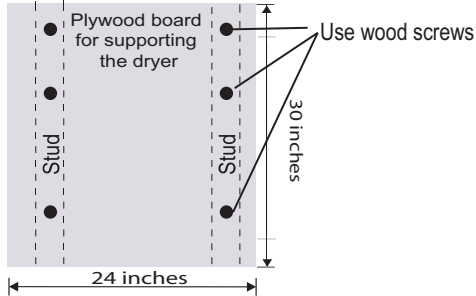

6. Mark the required dryer bracket position and holes using the template provided.

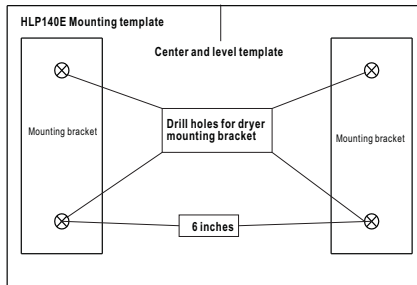

7. Using the 4 supplied screws attach the 2 wall hanging mounting brackets onto the plywood. The distance between each bracket should be 6" apart.

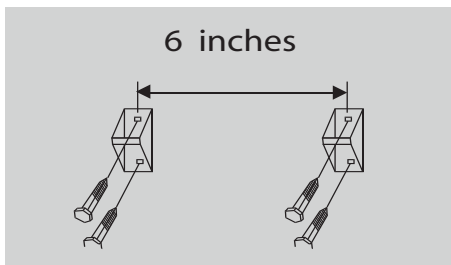

You are now ready to hang the dryer to the wall.

# INSTALLATION INSTRUCTIONS

## 8. Putting Dryer on wall.

Lift the dryer (with the help of an assistant) and insert the hanging hook onto the 2 mounting brackets on the wall. The wall spacer will distance the dryer from the bottom.

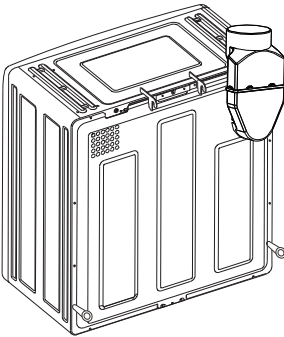

Hang dryer onto mounting brackets on the wall

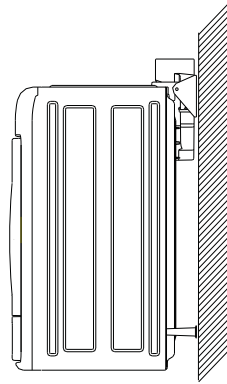

## 9. Connect ducting to the Dryer

Connect the exhaust ducting (not provided) from the dryer venting housing to external outside dryer vent using a hose clamp (not provided).

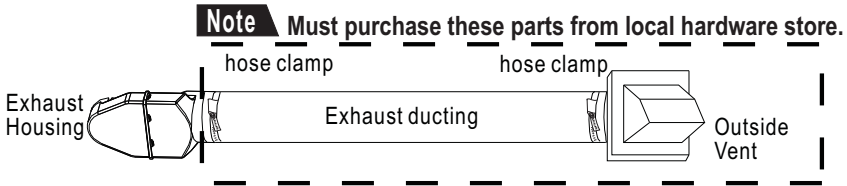

## 10. Completed final installation, on wall with ducting

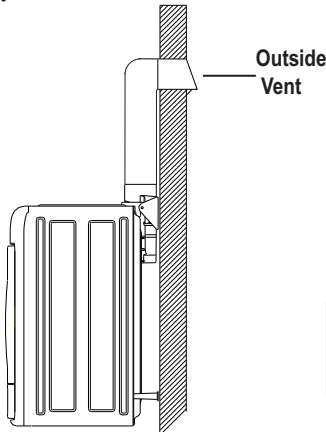

**Note**

Vent to the outside only. Improper taping to vent or unstable installation to vent will cause undesirable drying performance.

# OPERATING INSTRUCTIONS

## Control Panel Function

### LED Indicator lights

- Flashing LED- indicates the program is functioning
- LED On- indicates function selected or the program, that is going to begin.

### Status Indicator lights

- **Dry**  
The dryer is on.
- **Cooling**  
The final drying cycle will be completed soon, and the dryer stopped heating and is cooling down.
- **End Cycle**  
The cycle is completed; take out laundry.
- **Clean Filter**  
LED reminds you to clean the lint filter each time you finish drying your clothes.

### 'PowerOn/Off' button

- Press in the 'PowerOn/Off' button to turn on the power of the dryer

### 'Start/Pause' button

- With Power 'ON'
- Press the 'Start/Pause' button to start Drying Cycle, pause operation, or resume operation.

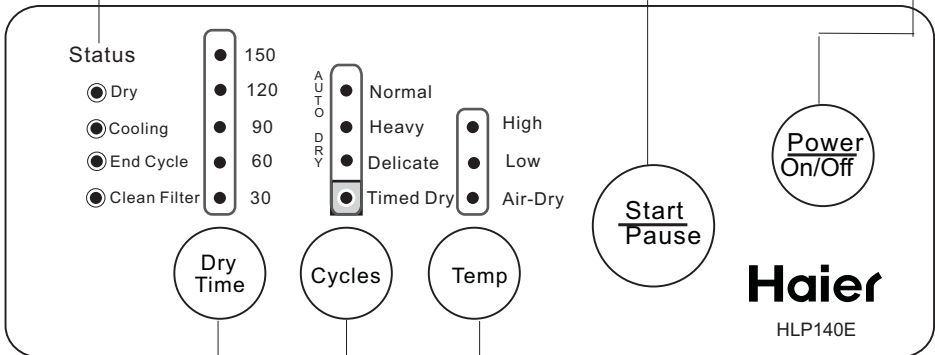

### 'Dry Time' button

- When in **Timed Dry**- Use the Dry Time button to manually select drying time in a range of 30, 60, 90, 120, or 150 minutes.

#### Note

- If 'Temp' function is set to 'Air-Dry', the 'Dry Time' is pre-set to select only 30 or 60 minutes.

### 'Cycle' button

Choose Drying Cycle	
Normal	Normal drying
Heavy	Huge and heavy garments
Delicat	Low level heat drying
Timed Dry	You can manually set the drying time and temperature.

### 'Temp' button

- When in **Timed Dry**- Use the Temp button to manually select the temperature range to High, Low and Air Dry temperature settings. (Air Dry is without any heat)

#### Note

- 'Normal' and 'Heavy' Cycles are pre-set to the 'High' temperature setting. 'Delicate' is pre-set to 'Low' temperature setting.

- Use the Timed Dry Cycle for manual selecting Dry times and Temperatures

# OPERATING INSTRUCTIONS

## Quick Start

### Normal , Heavy and Delicate Cycle Laundry Loads

#### 1. Connect AC plug to 120 Volt outlet.

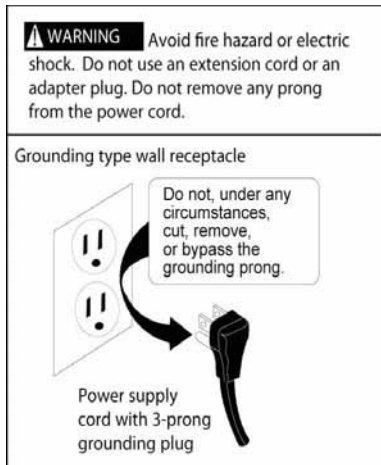

#### 2. Load your dryer with clothing;



#### **Note**

#### **Do not overload the Dryer**

It is suggested that 2/3 the capacity of drum be filled to allow for tumbling and proper drying.

# OPERATING INSTRUCTIONS

## Quick Start

Normal , Heavy and Delicate Cycle Laundry Loads

### 3. Set Cycle and Start

To start drying a laundry load using Auto Dry with presets for Temperature and Time, there are 3 easy steps:

1. Turn 'Power ON'



2. Choose drying Cycle –  
Normal, Heavy or Delicate



3. Press 'Start'

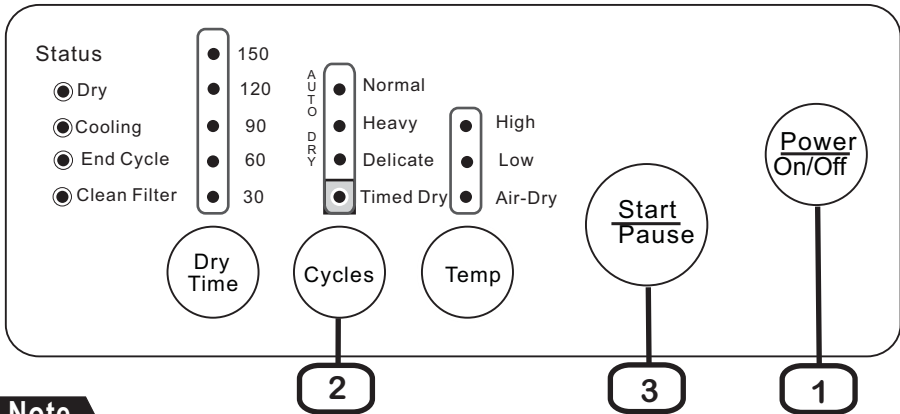

## Note

Normal , Heavy and Delicate Cycles are auto-set for Temperature and Time to dry a regular load. Timed Dry Cycle is for manual selecting Dry times and Temperatures. (See next page for instructions)

### 4. Cooling Status.

When 'Cooling' Status LED is ON, the Cooling down time takes 10 minutes for dryer along with the garments.

If you want to take out clothes in the middle of drying cycle, **please use caution** and carefully take out the HOT clothes.

### 5. End Dry Cycle

A beeper alarm alerts you when the Drying Cycle ends, then the dryer will power down.

**Take out the clothes as soon as possible.**

### 6. Clean Filter

'Clean Filter' Status LED reminder goes ON. After drying each load of clothing, always clean the lint filters.

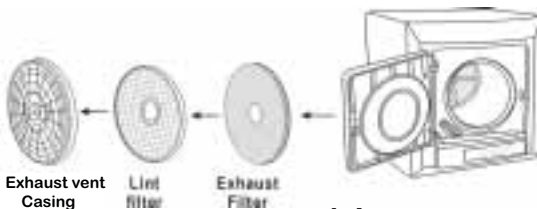

# OPERATING INSTRUCTIONS

## Timed Dry Cycle Manual

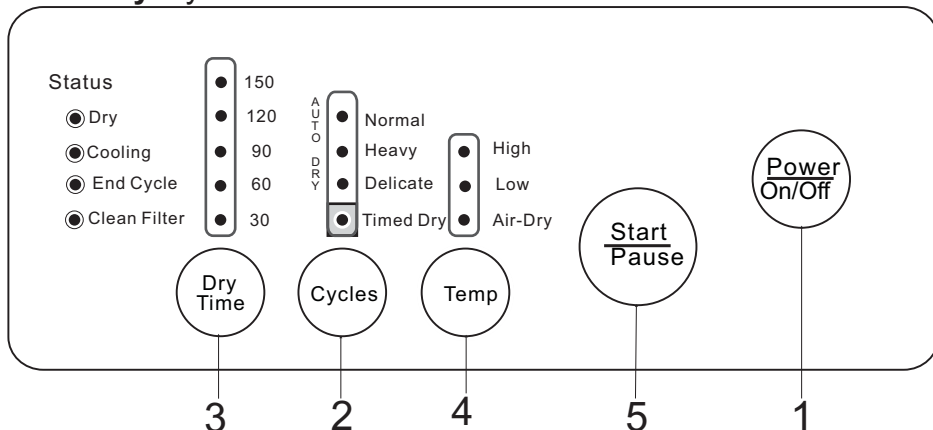

The Timed Dry Cycle is for manual selecting Dry times and Temperatures.

For Timed Dry operation. 1. Turn 'Power ON'		2. Choose dry Cycle – Set Cycle to 'Timed Dry'.	
3. Press Dry Time button to manually select drying time in a range of 30, 60, 90, 120, or 150 minutes.		4. Press Temp button to manually select the temperature range to High, Low and Air Dry temperature settings.	
5. Press 'Start'			

### 6. Cooling Status.

When 'Cooling' Status LED is ON, the Cooling down time takes 10 minutes for dryer along with the garments.

If you want to take out clothes in the middle of drying cycle, please use caution and carefully take out the HOT clothes.

### 7. End Dry Cycle

A beeper alarm alerts you when the Drying Cycle ends, then the dryer will power down.

**Take out the clothes as soon as possible.**

### 8. Clean Filter

'Clean Filter' Status LED reminder goes ON. After drying each load of clothing, always clean the lint filters.

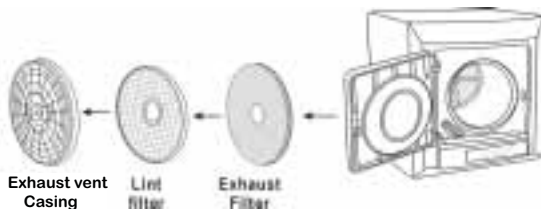



## **⚠ CAUTION!**

- The tumble dryer is intended only for drying textile material washed in water.
- Disconnect this appliance from the power supply before attempting any user maintenance other than cleaning the lint trap.
- Connect to individual AC power outlet .
- Do not allow children to play on or in the dryer.
- Only place damp clothes in your dryer .
- This dryer is not to be used for clothing or fabrics cleaned by chemicals.
- Do not allow lint to collect around the dryer or exhaust vents.

## **⚠ WARNING: CLEAN THE LINT TRAP REGULARLY**

### **Cleaning the Exhaust Filters**

- Clean lint screen after each drying load.
- NEVER use your dryer without the filter.

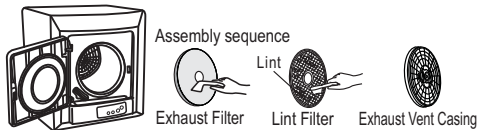

**Refer to User Manual for all instructions.**

## **⚠ Caution, risk of fire**

- All clothing dryers produce combustible lint. The dryer must be connected to an external exhaust vent outdoors. Regularly inspect the outdoor exhaust vent opening and remove any of lint around the exhaust opening and the surrounding area.
- To reduce the risk of fire, do not use heat when drying articles containing foam rubber or similarly textured rubber-like materials.

## **⚠ WARNING**

- Do not locate your dryer in a place with heavy moisture, like the bathroom, near water taps and places where it could easily be sprayed.
- Do not place any wet laundry, liquid detergent or bleach on the control panel of your dryer.
- Only place damp clothing into your dryer. Sufficiently wring out wet clothes with washer spin cycle to prevent longer drying time.
- Do not leave washed wet clothes in your dryer for a long time. This may result in water leakage or clothing od.



- To reduce the risk of electric shock or fire, do not use an extension cord with this appliance.

## Drying Tips and Precautions

**Delicate clothes** especially those with ribbon or lace, should be placed in a nylon mesh bag before drying to prevent tangling.

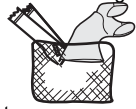

### **Clothes with zippers**

Zippers, buckles, buttons and fasteners should be closed or clothing should be turned inside out to reduce the impact of noise between metal and the drum.



### **Solvents**

- Do not wash or dry articles that have been cleaned in, washed in, soaked in or spotted with combustible or explosive substances (such as wax, oil, paint, gasoline, degreasers, dry-cleaning solvents, kerosene, etc.). These substances give off vapors that may ignite or explode. Do not add these substances to the wash water. Do not use or place these substances around your washer or dryer during operation.

- Do not place items exposed to cooking oils in your dryer. Items contaminated with cooking oils may contribute to a chemical reaction that could cause a clothes load to catch fire.

- Any article on which you have used a cleaning solvent or that contains flammable materials (such as cleaning cloths, mops, towels used in beauty salons, restaurants or barber shops, etc.) must not be placed in or near the dryer until solvents or flammable materials have been removed. There are many highly flammable items used in homes such as acetone, denatured alcohol, gasoline, kerosene, some household cleaners, some spot removers, turpentine, waxes, wax removers and products containing petroleum distillates.

### **Elastics**

Do not dry articles containing rubber, plastic or similar materials such as padded bras, tennis shoes, rubber galoshes, bath mats, rugs, bibs, baby pants, plastic bags, pillows, etc. that may melt or burn. Some rubber materials, when heated, can under certain circumstances produce fire by spontaneous combustion.

### **Fabrics**

- Make sure to check if there are any special requirements or warning labels on garments before drying. Carefully follow the garment manufacturer's care instructions.

- Avoid clothes being caught by the door which will cause clothes to tangle and damage the door gasket.

- Separate dark and light colored items, like you do for washing.

- Check for stains that may not have been removed in washing.

- Dryer heat may permanently set some stains. Properly dried clothes will need minimum care when removed from dryer.

- For optimum results, use dryer load with cloths of similar fabric, weight and construction.

**Always remove the clothing from the dryer as soon as possible.**

# Care And Cleaning Guide

- Clean buildup such as lint on filters after each use, otherwise it will affect the performance of your dryer.

## Cleaning of Lint trap and Filters

- The lint filter must be always used for drying.
- It must be cleaned each time before or after each use.

1. Remove the Exhaust venting casing containing the filters.

Use four finger grabbing holes in middle of the exhaust vent casing center to pull from the drum. Remove the filters by pulling straight out. The exhaust vent casing contains the 'Lint filter' and 'Exhaust filter', as shown in figure 1.

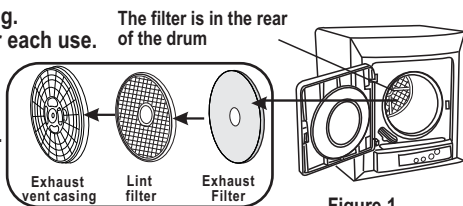

2. Cleaning the filters from lints

Separate 'exhaust vent casing', 'lint filter' and 'exhaust filter' and clean the lint off the filter and exhaust filter with a soft brush or a small vacuum cleaner. (as shown in figure 2) or wash it with water if still dirty. Dry completely before use and do not damage the filters.

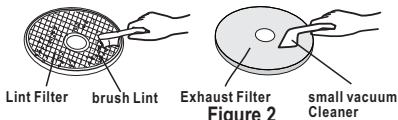

3. Install the filters

After cleaning the filters, assemble filters in the order of 'exhaust vent casing', 'lint filter' and 'exhaust filter' (as shown in figure 3).

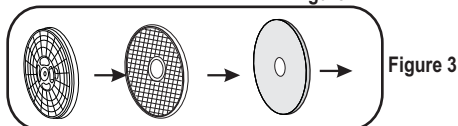

4. Align the recesses center of the 'exhaust vent casing' to the center of drum and make sure that it is firmly inserted.

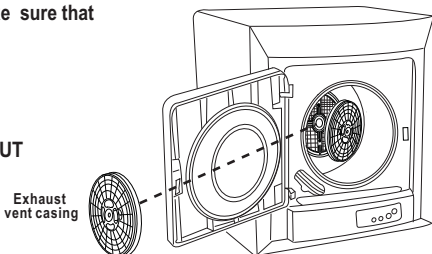

**NEVER USE YOUR DRYER WITHOUT THE LINT FILTERS INSTALLED.**

- Please unplug the power cord when cleaning the Dryer.
- Clean the interior drum or dryer housing with a damp soft cloth.

### **WARNING**

- Do not put water directly on dryer.
- Do not use thinner, gasoline or alcohol.
- Do not use any type of spray cleaner to clean the interior.
- Remove everything from drum before drying the next load.
- Clean cabinet with mild soap and water only. Do not use harsh or abrasive cleaners, as this could damage the dryer.



# Troubleshooting

Check your problem by using the chart below (If problems occur, please pull out the plug before examining) and try the solutions for your problem. If the dryer still does not work properly, contact Haier customer service center or the nearest authorized service center.

Symptom	Possible Cause	Possible Remedy
Dryer won't work.	<ul style="list-style-type: none"> <li>● No power to machine?</li> <li>● Power plug not in the socket?</li> <li>● Front door not properly shut?</li> </ul>	<ul style="list-style-type: none"> <li>● Put Power plug in socket.</li> <li>● Reset circuit breaker or replace fuses.</li> <li>● Close the front door. Press in the Power/ ON/OFF, or Start/Pause button.</li> </ul>
Dryer won't heat.	<ul style="list-style-type: none"> <li>● Heating Temperature was not set for Timed Dry?</li> <li>● Is Temperature Indicator LED indicating 'Air Dry'?</li> <li>● Outside venting ducting is blocked?</li> <li>● The Exhaust Filter is blocked?</li> </ul>	<ul style="list-style-type: none"> <li>● Reset the 'Temp' button till the indicator light indicates 'High' or 'Low', and the LED is on.</li> <li>● Change Temp. settings to High or Low: Air Dry works without heat.</li> <li>● Make sure outside vent is not blocked</li> <li>● Remove and clean Exhaust vent</li> </ul>
Garments won't dry enough.	<ul style="list-style-type: none"> <li>● Garments were not wringed out sufficiently by washer spin cycle.</li> <li>● Overloaded dryer with too many garments ?</li> <li>● Clothes not sorted to proper cycle selection?</li> </ul>	<ul style="list-style-type: none"> <li>● Check that Garments are wringed out sufficiently by washer spin cycle.</li> <li>● Reduce the amount of garments loaded in dryer.</li> <li>● Select the right drying cycle for normal, heavy or delicate laundry loads.</li> </ul>
Drum won't turn. (The four indicator lights of Cycle button are on at the same time)	<ul style="list-style-type: none"> <li>● Is the front door closed?</li> </ul>	<ul style="list-style-type: none"> <li>● Close front door and Press the Start/Pause button.</li> </ul>

## WARNING

Never Overload the dryer.

Never put wet clothing that was not wringed out during washer spin cycle.

If you can not find a solution- remove plug from outlet pending resolution.

# Limited Warranty



If you need service, please first see the 'Troubleshooting' section of the User Manual. After checking 'Troubleshooting', additional help is available by calling Haier America Customer Service Hot Line 24 hours a day, 7 days a week. Please call 1-877-337-3639.

## Limited Warranty

### What is covered and for how long?

This warranty covers all defects in workmanship or materials for a period of:

12 months for labor

12 months for parts (Functional Parts Only)

The warranty commences on the date of item purchase. Customer shall provide Haier with proof of the date of purchase and the original receipt along with: brand, model and serial number for verification prior to any warranty service being provided.

**In -Home Service is available at the discretion of Haier America.**

**EXCEPTIONS:** Commercial or Rental Use warranty

90 days for labor 90 days for parts

No other warranty applies.

### What is covered:

1. The mechanical and electrical parts of the appliance which serve the functional purpose of this appliance are covered for a period of 12 months or as stated above. This includes all parts except finish, trim and glass.
2. The limited warranty does not cover any credit or refund for any loss or injury caused by the product or defects to the product including but not limited to incidental or consequential damages.

### What will be done?

1. Any mechanical or electrical part that proves to be defective in normal usage during the specified warranty period will be repaired or replaced at Haier's discretion.

**ALL WARRANTY SERVICE MUST BE PROVIDED BY ONLY OUR FACTORY SERVICE CENTERS, OR BY AN AUTHORIZED HAIER CUSTOMER TECHNICIAN.**

If it is determined that repair is not appropriate or replacement parts are unavailable for repair, Haier will exchange the product with a refurbished or new product the same or similar to the original at its discretion.

2. There will be no charge to the purchaser for functional replacement parts and labor on any covered items during the initial 12- month period or as stated above.

3. **THIS WARRANTY COVERS APPLIANCES WITHIN THE CONTINENTAL UNITED STATES, PUERTO RICO AND CANADA. IT DOES NOT COVER THE FOLLOWING:**

# Limited Warranty

Damages from improper installation. Damages incurred during shipping. Defects other than manufacturing. Damage from misuse, abuse, accident, alteration, lack of proper care and maintenance or incorrect current or voltage or acts of G-D. Damage from other than household use. Damage from service by other than an authorized dealer or service center. Decorative trims, glass or replaceable light bulbs. Transportation and shipping costs. Labor (after the initial 12 months). Credit or Refund for products over 30 days past date of purchase This limited warranty doesn't apply to refurbished product or unit purchased as/like new or second-hand. THIS LIMITED WARRANTY IS GIVEN IN LIEU OF ALL OTHER WARRANTIES, EXPRESSED OR INCLUDING THE WARRANTIES OF MERCHANTABILITY AND FITNESS FOR A PARTICULAR PURPOSE. The remedy provided in this warranty is exclusive and is granted in lieu of all other remedies. This warranty does not cover incidental or consequential damages, so the above limitations may not apply to you. Some States do not allow limitations on how long an implied warranty lasts, so the above limitations may not apply to you. This warranty gives you specific legal rights, and you may have other rights, which vary from State to State.

Haier America, New York, NY 10018

To have your product serviced, please contact Haier America Customer Service Hot Line 24 hours a day, 7 days a week. In the U.S.A., call 1-877-337-3639.

# Mount the Haier Dryer over any of Haier's 6 Portable Washers

Both Washer and Dryer Use Standard  
120 Volt Outlets:

You Can Install Them Anywhere!

## PLUGS INTO ANY HOUSEHOLD OUTLET



- Uses Standard 120 Volt – 15 amp Outlets
- No Special wiring required
- Easy Installation



Equal Wash Capacity to the HLP140E Dryer



Larger Wash Capacity than the HLP140E Dryer



The Ultimate Drying Convenience for Portable Washers  
used in Apartments, dorms, offices, hotel rooms, or homes.

**Haier**  
Quality Innovation Style



# **IMPORTANT**

Do Not Return This Product To The Store

If you have a problem with this product, please contact the 'Haier Customer Satisfaction Center' at 1-877-337-3639.

DATED PROOF OF PURCHASE REQUIRED FOR WARRANTY SERVICE

# **IMPORTANT**

Ne pas Réexpédier ce Produit au Magasin

Pour tout problème concernant ce produit, veuillez contacter le service des consommateurs 'Haier Customer Satisfaction Center' au 1-877-337-3639.  
UNE PREUVE D'ACHAT DATEE EST REQUISE POUR BENEFICIER DE LA GARANTIE.

# **IMPORTANTE**

No regrese este producto a la tienda

Si tiene algún problema con este producto, por favor contacte el 'Centro de Servicio al Consumidor de Haier' al 1-877-337-3639 (Válido solo en E.U.A).  
NECESITA UNA PRUEBA DE COMPRA FECHADA PARA EL SERVICIO DE LA GARANTIA

# Haier America

## New York, NY 10018

HLP140E

User Manual

Issued: JUNE 2008

Printed in China

Made in China

Fabriqu  en Chine

Hecho en China

Part # 0030806837D-90