

Haier

**Bottom Mount No Frost
Refrigerator**

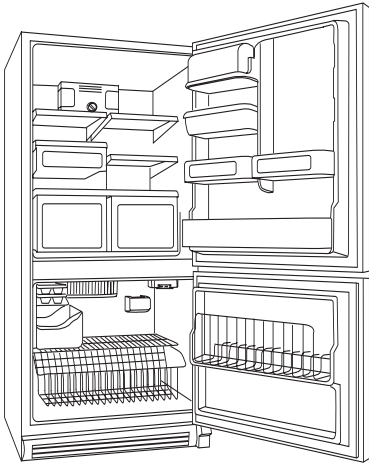

**Refrigerateur
Sans Gel Monte
de Dessous**

**Refrigerador
de Montaje Inferior Sin
Escarcha**

User Manual-

Model #

HBE18

Guide de l'Utilisateur-

Modèle

HBP18

Manual del Usuario-

Para Modelo de

HBQ18

SAFETY PRECAUTIONS

Read all of the instructions before using this appliance. When using this appliance, always exercise basic safety precautions, including the following:

- 1) Use this appliance only for its intended purpose as described in this use and care guide.
- 2) This refrigerator must be properly installed in accordance with the installation instructions before it is used. See grounding instructions in the installation section.
- 3) Never unplug your refrigerator by pulling on the power cord. Always grasp the plug firmly and pull straight out from the outlet.
- 4) Repair or replace immediately, all electric service cords that have become frayed or otherwise damaged. Do not use a cord that shows cracks or abrasion damage along its length, the plug or the connector end.
- 5) Unplug your refrigerator before cleaning or before making any repairs.
NOTE: *If for any reason this product requires service, we strongly recommended that a certified technician performs the service.*
- 6) Do not use any electrical device or any sharp instrument in defrosting your refrigerator.
- 7) If your old refrigerator is not being used, we recommend that you remove the doors. This will reduce the possibility of danger to children.
- 8) After your refrigerator is in operation, do not touch the cold surface in the freezer compartment, particularly when hands are damp or wet. Skin may adhere to these extremely cold surfaces.
- 9) Do not refreeze foods, which have been thawed completely. The United States Department of Agriculture in Home and Garden Bulletin No.69 reads: "...You may safely refreeze frozen foods that have thawed if they still contain ice crystals or if they are still cold-below 40F".

"...Thawed ground meats, poultry, or fish that have any off-odor or off-color should not be refrozen and should not be eaten. Thawed ice cream should be discarded. If the odor or color of any food is poor or questionable, discard it. The food may be dangerous to eat."

"...Even partial thawing and re-freezing reduce the eating quality of foods, particularly fruits, vegetables, and prepared foods. The eating quality of red meats is affected less than that of many other foods. Use refrozen foods as soon as possible, to save as much of its eating quality as you can."

- 10) This refrigerator should not be recessed or built-in an enclosed cabinet. It is designed for freestanding installation only.
- 11) Do not operate your refrigerator in the presence of explosive fumes.

SAVE THESE INSTRUCTIONS

For Future Reference

DANGER

Risk of child entrapment. Before you throw away your old refrigerator or freezer, take off the doors. Leave the shelves in place so that children may not easily climb inside.

As per UL 250 Standards

Thank you for using our Haier product. This easy-to-use manual will guide you in getting the best use of your refrigerator.

Remember to record the model and serial number. They are on a label in back of the refrigerator.

Model number

Serial number

Date of purchase

Staple your receipt to your manual. **You will need it to obtain warranty service.**

Table of Contents

	PAGE
Safety Precautions	1
Parts And Features	4
Installing Your Refrigerator	5
Unpacking Your Refrigerator	5
Adjusting Your Refrigerator	5
Proper Air Circulation	5
Electrical Requirements.....	6
Use of Extension Cords	6
Door Handle Installation.....	7
Door Alignment.....	8
Reversing the Door Swing	8
Reversing the Door Handles.....	11
Refrigerator Features And Use	12
Setting the controls	12
Adjusting control settings	12
Refrigerator Interior Shelves	13
Utility Drawer And Cover.....	14
Crisper and Crisper Cover	15
Refrigerator Door Shelves	17
Freezer Features	18
Changing the Light Bulb.....	20
Food Storage Information	20
Normal Operating Sounds.....	22
Proper Refrigerator Care and Cleaning	23
Cleaning and Maintenance	23
Light Bulb Replacement	24
Power Interruptions	24
Vacation and Moving Care	24
Troubleshooting	25
Warranty Information	27

Parts And Features

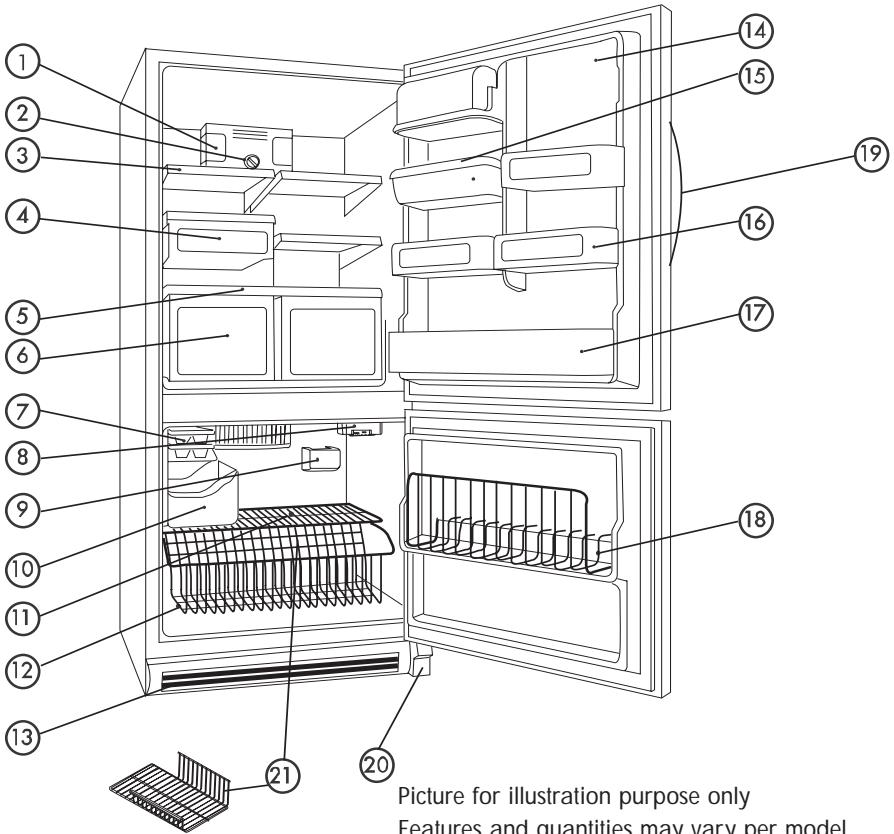

Picture for illustration purpose only
Features and quantities may vary per model

- | | |
|--------------------------------|--------------------------------------|
| 1. Refrigerator Light | 12. Wire Basket |
| 2. Refrigerator Control | 13. Base Grille |
| 3. Half-Width Glass Shelf | 14. Dairy Bin |
| 4. Deli Drawer | 15. Egg Bin |
| 5. Crisper Cover | 16. Door Storage Bin |
| 6. See-Through Crisper Drawers | 17. Bin Door Shelf |
| 7. Ice Tray | 18. Tilt-out Wire Door Shelf |
| 8. Freezer Control | 19. Door Handle |
| 9. Freezer Light | 20. Freezer Door Hinge Cover |
| 10. Ice Storage Container | 21. Adjustable Freezer Shelf Divider |
| 11. Freezer Shelf | |

Installing Your Refrigerator

Unpacking Your Refrigerator

1. Remove all packaging material. This includes the foam base, all adhesive tape holding, refrigerator accessories inside and outside, and the plastic stoppers holding the shelves. Slide out and remove plastic or foam guard used to secure the compressor from shipping damage due to vibration and shock.
2. Inspect and remove any remains of packing, tape or printed materials before powering on the refrigerator.

Adjusting Your Refrigerator

Leveling Your Refrigerator:

- Your refrigerator has two leveling legs, which are located in the front corners of your refrigerator. After properly placing your refrigerator in its final position, you can level your refrigerator.
- Leveling legs can be adjusted by turning them clockwise to raise your refrigerator or by turning them counterclockwise to lower your refrigerator. The refrigerator door will close easier when the leveling legs are raised.

Proper Air Circulation

- To assure your refrigerator works at the maximum efficiency it was designed for, you should install it in a location where there is proper air circulation, plumbing and electrical connections.
- The following are recommended clearances around the refrigerator:

Sides.....	3/4 "	(19mm)
Top.....	2"	(50mm)
Back.....	2"	(50mm)

Electrical Requirement

- Make sure there is a suitable power Outlet (115 volts, 15 amps outlet) with proper grounding to power the refrigerator.
- Avoid the use of three plug adapters or cutting off the third grounding in order to accommodate a two plug outlet. This is a dangerous practice since it provides no effective grounding for the refrigerator and may result in shock hazard.

Use of Extension Cords

- Avoid the use of an extension cord because of potential safety hazards under certain conditions. If it is necessary to use an extension cord, use only a 3-wire extension cord that has a 3-blade grounding plug and a 3-slot outlet that will accept the plug. The marked rating of the extension cord must be equal to or greater than the electrical rating of the appliance.

Install Limitations

- Do not install your refrigerator in any location not properly insulated or heated e.g. garage etc. Your refrigerator was not designed to operate in temperature settings below 55° Fahrenheit.
- Select a suitable location for the refrigerator on a hard even surface away from direct sunlight or heat source e.g. radiators, baseboard heaters, cooking appliances etc. Any floor unevenness should be corrected with the leveling legs located on the front bottom corners of the refrigerator.

Door Handle Installation

Handle Installation of Refrigerator Door:

1. Take out door handle, screws and screw covers from refrigerator accessory bag.
2. Align the upper part of door handle with the screw hole of the upper edge of refrigerator door, and fix them by screws.
3. Align the lower screw holes of the door handle with the holes in the refrigerator door, fix them with screws, and cover them with screw covers.

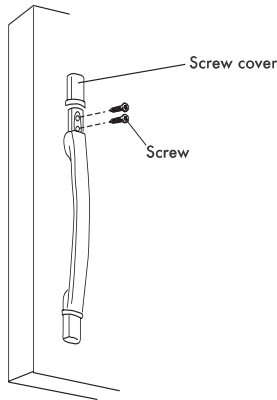

fig. #1

Handle installation of freezer door:

1. Take out door handle, screws and screw covers from refrigerator accessory bag.
2. Align handle with the screw hole on the right side of freezer door, and fix them by screws.
3. Align the door handle with the holes on the left side of the freezer door, fix them with screws, and cover them with screw covers.

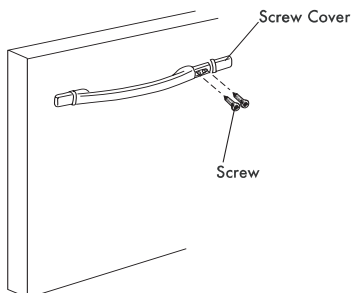

fig. #2

Door Alignment (see fig. # 3)

1. Remove refrigerator door hinge cover screw.
2. Remove the top hinge cover.
3. Loosen the top hinge screws using a Phillips head screwdriver.
4. Adjust the door or put a spacer in between and then tighten the screws.
5. Replace the top hinge cover.

Reversing the Door Swing

Left/right door opening method:

This product provides the reversing of the left/right door opening. You can select your preference of door opening by following the procedure to make the change.

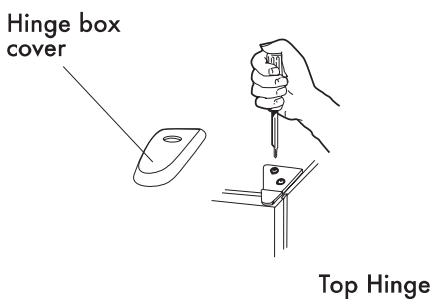

fig. # 3

Dismantling: (see fig. # 4)

1. Fix refrigerator and freezer door by sticking adhesive tape on both side to hold doors in place.
2. As shown in fig.3, dismantle the hinge box cover on the upper part of refrigerator door with a Phillips head screwdriver. Then remove the two screws from the hinge. Take out the hinge by pulling it vertically, and keep it in a safe place.
3. Remove the adhesive tape on refrigerator door, lift and take the door down, and carefully put it aside.
4. As shown in fig.4, dismantle three screws of the central hinge, lift and take down the central hinge, pad, and door stopper and keep them in a safe place.
5. Remove the adhesive tape on freezer door, lift and take down refrigerator door, and carefully put it aside.

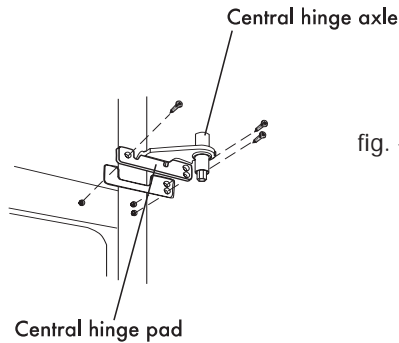
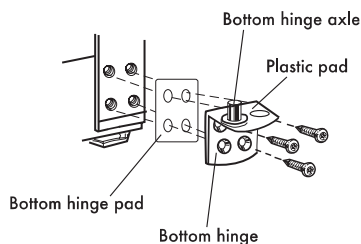

fig. # 4

Reinstallation: (see fig. #5 and #6)

1. Press and pull out the hinge cover from the hinge.
2. Before dismantling the lower hinge, remove the hinge axle and fix it on the opposite hole. As shown in fig.5, dismantle the lower hinge, and then install them on the left side.



3. Remove the door stop plate from the bottom of the door and put it on the opposite side of the door.
4. Install freezer door: make the left bottom hole of the freezer compartment door fall over the lower hinge axle, move back and forward the door to make it straight and in alignment with central hinge. Install the central hinge again, turn the hinge axle until it completely enters the door body, and then fix it with screws.

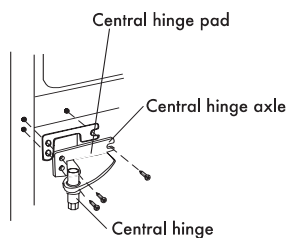

5. As shown in fig. 6, install the central hinge and pad to the left side.
6. Install refrigerator door: make the left bottom hole of refrigerator door fall over the central axle; raise upper hinge, so that hinge axle can be installed in the upper hole of the upper part of the refrigerator door; adjust door to make it straight and level. Tighten the screws of upper hinge.
7. As shown in fig.3, install the upper refrigerator hinge to the left corresponding side.
8. Replace the hinge cover as shown in fig.3.

Reversing the Door Handles

Refrigerator: (see fig. #7)

1. Remove screw cover from the handles.
2. Using a Phillips head screwdriver, remove the inside screw and both the screws at the bottom of the freezer door that holds the handle.
3. Install the handle on the opposite side.
4. Remove screw plugs.
5. Install the screws and the screw cover on their corresponding position.

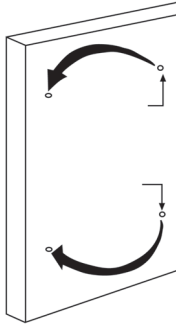

fig. # 7

Refrigerator Features And Use

Setting the Controls:

For your convenience, your refrigerator controls are preset at the factory. When you first install your refrigerator, make sure that the controls are still preset. The Refrigerator Control and the Freezer Control should both be at "4"(MID) as shown in the illustrations below.

The Refrigerator Control adjusts the refrigerator compartment temperature and is located on the upper rear wall in the refrigerator section. Settings to the left of the mid-setting make the temperature less cold. Settings to the right of the mid-setting make the temperature coldest.

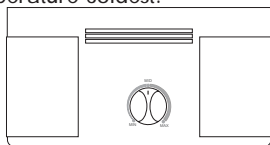

The Freezer Control adjusts the freezer compartment temperature and is located at the top of the freezer section.

Setting to the left of the mid-setting make the temperature less cold. Settings to the right of the mid-setting make the temperature coldest.

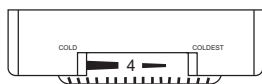

Give your refrigerator time to cool down completely before adding food. It is best to wait 24 hours before you put food into the refrigerator.

IMPORANT: If you add food before the refrigerator has cooled completely, your food may spoil. **Turning the Refrigerator and Freezer Control to a higher (colder) than compartments any faster.**

Adjusting Control Settings

Give the refrigerator time to cool down completely before adding food. It is best to wait 24 hours before you put food into the refrigerator. The settings indicated in the previous section should be correct for normal household refrigerator usage. The controls are set correctly when milk or juice is as cold as you like and when ice cream is firm.

If you need to adjust temperatures in the refrigerator or freezer, use the settings listed in the chart below as a guide.

Always remember to wait at least 24 hours between adjustments.

CONDITION/REASON:	RECOMMENDED ADJUSTMENT:
REFRIERATOR section Too warm	Turn REFRIGERATOR CONTROL to next higher number, wait 24 hours, then re-check
-Door opened often	
-Large amount of food added	
-Room temperature very warm	
FREEZER section too warm/ice not made fast enough	Turn FREEZER CONTROL to next higher number, wait 24 hours, then re-check
-Door opened often	
-Large amount of food added	
-very cold room temperature (can't cycle often enough)	
-Heavy ice usage	
REFRIERATOR section too cold	Turn REFRIGERATOR CONTROL to next lower number, wait 24 hours, then re-check
-Control not set correctly for your conditions	
FREEZER section too cold	Turn FREEZER CONTROL to next lower number, wait 24 hours, then re-check
-Control not set correctly for your conditions	

Refrigerator Interior Shelves

The refrigerator shelves of your refrigerator were designed with you in mind. Their varied adjustability allows you to satisfy your personal storage needs. Your model may have wire, glass, or no spill glass shelves. Your model may have full-width or half-width shelves. Only your model purchase and your imagination limit the possibilities.

To remove glide-out shelf: (see fig.#8)

1. Gently pull out the shelf until the shelf has been completely removed.

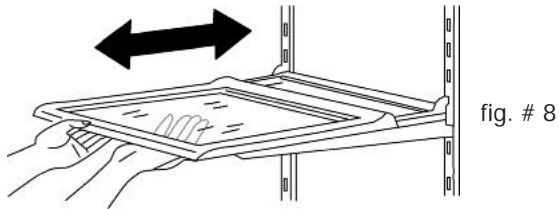

To remove a full-width or half-width cantilevered shelf
(see fig.#9)

1. Tilt up front of the shelf until the rear shelf hooks are no longer locked in place in the rear metal shelf supports.
2. Pull the shelf gently until it is removed.

To replace a full-width or half-width cantilevered shelf:
(see fig.#9)

1. Guide the rear shelf hooks into the desired slots in the metal shelf supports located on the back refrigerator wall.
2. Tilt up front of the shelf to set the shelf hooks in place.
3. Lower the front of the shelf into position until the rear hooks lock into the slots of the metal shelf supports.

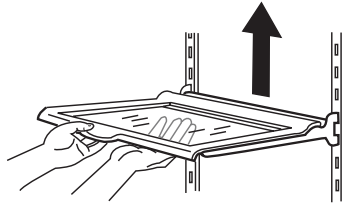

fig. # 9

Utility Drawer and Cover

To remove the utility drawer: (see fig.#10)

1. Slide utility drawer out until it reaches the stop.
2. Grasp front of drawer with one hand while supporting the bottom of the drawer with the other hand. Slide drawer out gently the rest of the way.

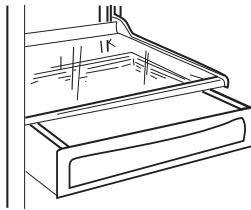

fig. # 10

To remove utility drawer cover shelf: (see fig.#11)

1. Remove utility drawer first following the above instructions.
2. Tilt up front of the shelf until the rear shelf hooks are no longer locked in place in the rear metal shelf supports.
3. Pull the shelf gently until it is removed.

To install utility drawer cover shelf: (see fig.#11)

1. Guide the rear shelf hooks into the desired slots in the metal shelf supports located on the back refrigerator wall.
2. Tilt up front of the shelf to set the shelf hooks in place.
3. Lower the front of the shelf into position until the rear hooks lock into the slots of the metal shelf supports.

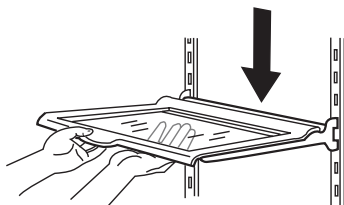

fig. # 11

Crisper and Crisper Cover

To remove and install the crisper: (see fig.#12)

1. Slide crisper straight out to the stop.
2. Gently lift the front of the crisper.
3. Grip the crisper firmly and slide out completely.
4. Replace the crisper by placing the crisper properly in its tracks and gently sliding it back into place.

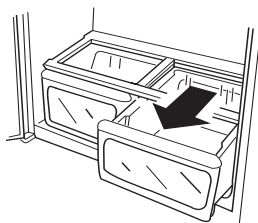

fig. # 12

To remove the crisper cover: (see fig.#13)

1. First remove both crispers (see page 15).
2. Gently push upward from the underside of the crisper cover to remove it from the crisper cover frame.
3. Carefully grasp the crisper cover and slide out to remove.
4. Lift crisper cover frame up and remove.

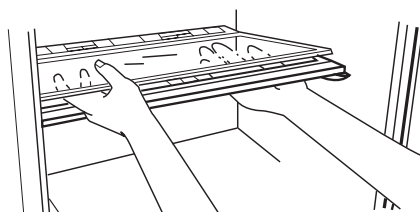

fig. # 13

To replace the crisper cover: (see fig.#13)

1. Insert the rear of the crisper cover frame into the support bracket the sidewalls of the refrigerator.
2. Lower the front of the crisper cover frame into place.
3. Slide the rear of the crisper cover into the frame and carefully lower the front into place.
4. Replace the crispers as previously instructed.

Crisper Humidity Control: (see fig.#14)

Your refrigerator model may be equipped with slide controls to raise or lower the humidity levels of your crispers. This feature will increase the storage life of your fruits and vegetables. Simply adjust the controls to the appropriate setting for the items you are storing in the crispers.

- LOW setting allows moist air to exit the crisper for optimum storage of fruits and/or vegetables, which have skins.
- HIGH setting retains moist air in the crisper for optimum storage of fresh, leafy vegetables.

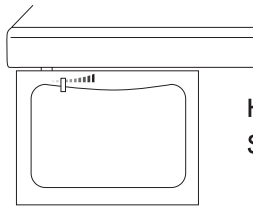

High/Low
Settings

fig. # 14

Refrigerator Door Shelves

Gallon door storage: (see fig.#15)

Your refrigerator may be equipped with gallon door storage shelves. This feature will allow for the storage of gallon size containers.

To remove refrigerator door shelves: (see fig.#15)

1. Remove all items stored on the shelf.
2. Gently push up each side until the shelf is clear of the door shelf brackets and then remove.

To replace refrigerator door shelves: (see fig.#15)

1. Align the ends of the shelves with the door shelf brackets.
2. Carefully push down on each end of the door shelf until it is locked in place in the refrigerator door brackets.

fig. # 15

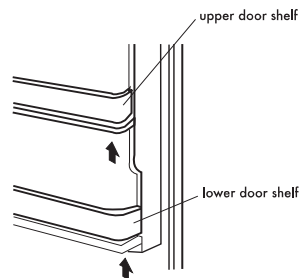

To adjust the door shelf bottle huggers: (see fig.#16)

1. Grasp the hugger firmly and slide right or left until it is snug against the items stored on the shelf.

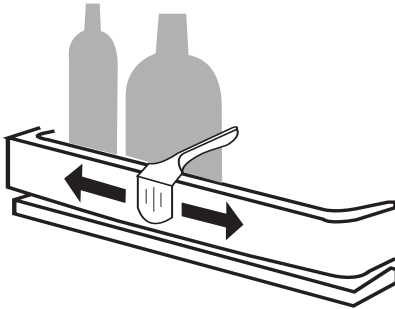
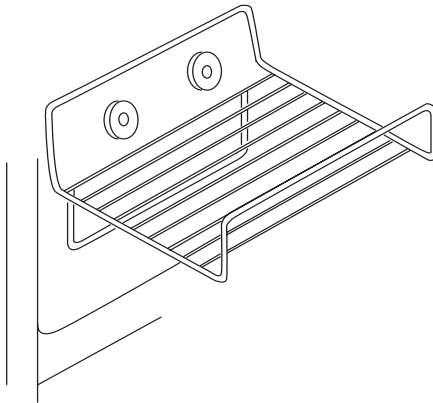

fig. # 16

Freezer Features

Ice Service Rack

Install ice service rack by placing ice service rack on washers and sliding down.



Slide-out Shelf:

Slide out shelf pulls forward for easy access to items in back.

- Remove slide-out shelf by sliding forward until ballpoint beneath center rail catches in molding groove.
- Grasp shelf by center rail, pull up, and remove.
- Slide in until ballpoint falls into molding groove.

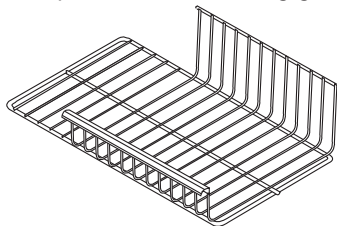

fig. # 17

Vertical Shelf Divider

Install vertical shelf divider by completing the following steps:

1. Slide prongs of shelf divider beneath desired grill work, slightly off-center from center rail.
2. Press top of divider down and slide hook assembly beneath center rail.

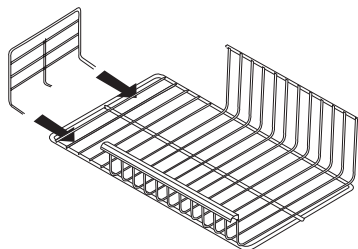

fig. # 18

Wire Basket

Wire basket slides out for easy access to items in back.

- Remove wire basket by lifting and pulling out.
- Replace wire basket by sliding in.

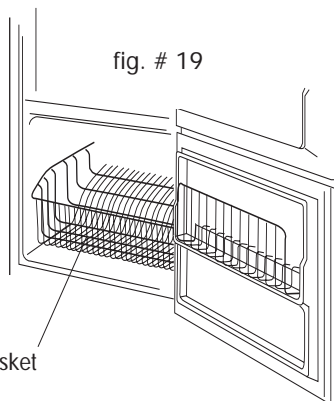

fig. # 19

Wire Basket

Changing the Light Bulbs

NOTE: Not all appliance bulbs will fit your refrigerator. Be sure to replace the bulb with one of the same size, shape, and wattage.

To change the refrigerator or freezer light bulb:

1. Unplug refrigerator or disconnect power.
2. Remove cover. Replace burned-out bulb with an appliance light bulb no greater than 40 watts.
3. Replace light cover.
4. Plug in refrigerator or reconnect power.

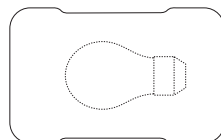
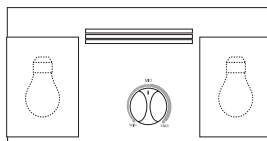

Food Storage Information

Fresh Food

- When storing fresh food, which is not prepackaged, be sure to wrap or store food in airtight and moisture proof material unless otherwise noted. This will ensure proper shelf life and prevent the transfer of odors and tastes.
- Wipe containers before storing to avoid needless spills.
- Eggs should be stored in an upright position in their original carton to maximize shelf life.
- Fruit should be washed and dried then stored in a crisper set for low humidity. If you do not have humidity controlled crisper place the items in sealed plastic bags before storing in the crisper.
- Vegetables with skins should be stored in plastic bags or containers and stored in crisper with low humidity setting.

- Leafy vegetables should be washed and drained and then stored in plastic bags or containers in crisper with high humidity setting.
- Hot food should be allowed to cool before storing in the refrigerator. This will prevent unnecessary energy use.
- Fresh seafood should be used the same day as purchased.
- When storing meats in the fresh food section, keep in the original packaging or rewrap as necessary. Follow the suggestions below for safe storage:
 - Chicken 1-2 Days
 - Ground Beef 1-2 Days
 - Cold Cuts 3-5 Days
 - Steak/Roasts 3-5 Days
 - Smoked/Cured Meats 7-10 Days
 - All others 1-2 Days

If longer periods of storage are required, store immediately in the freezer section.

Frozen Food

- Proper freezer storage requires correct packaging. All foods must be in packages, which do not allow the flow of air or moisture in, or out. Improper storage will result in odor and taste transfer and will result in the drying out of the improperly packaged food.
- Follow package or container instructions for proper storage.
- **Packaging Recommendations:**
 - Plastic containers with airtight lids
 - Heavy-duty aluminum foil
 - Plastic wrap made from saran film
 - Self-sealing plastic bags
- Do not refreeze defrosted/thawed foods.
- It is recommended that the freezing date be marked on the packaging.

Normal Operating Sounds You May Hear

- The fan circulating air inside the interior of your unit to maintain the temperature you have selected.
- Boiling water, gurgling sounds or slight vibrations that are the result of the refrigerant circulating through the cooling coils.
- Sizzling or popping sounds resulting from frost melting during the defrost cycle and dripping on the defrost cycle.
- The sound of dripping water as ice melts from the evaporator and flows into the drip pan during the defrost cycle.
- Cracking or popping sound caused by the expansion and/or contraction of the cooling coils during the defrost cycle.
- Both the defrost timer and the thermostat control will click when they cycle on and off.

Proper Refrigerator Care and Cleaning

Cleaning and Maintenance

Warning: To avoid electric shock always unplug your refrigerator before cleaning. Ignoring this warning may result in death or injury.

Caution: Before using cleaning products, always read and follow manufacturer's instructions and warnings to avoid personal injury or product damage.

General:

- Prepare a cleaning solution of 3-4 tablespoons of baking soda mixed with warm water. Use sponge or soft cloth, dampened with the cleaning solution, to wipe down your refrigerator.
- Rinse with clean warm water and dry with a soft cloth.
- Do not use harsh chemicals, abrasives, ammonia, chlorine bleach, concentrated detergents, solvents or metal scouring pads. Some of these chemicals may dissolve, damage and/or discolor your refrigerator.

Door Gaskets:

- Clean door gaskets every three months according to general instructions. Gaskets must be kept clean and pliable to assure a proper seal.
- Petroleum jelly applied lightly on the hinge side of gaskets will keep the gasket pliable and assure a good seal.

Light Bulb Replacement

1. Switch off power to refrigerator.
2. Remove the highest shelf.
3. Allow light bulb to cool before removing.
4. Remove the bulb by screwing it counter-clockwise.
5. Always replace with appliance type light bulb rated at 40 watts or lesser wattage.
6. Do not exceed the 40 watts rating at any time.

Power Interruptions

- Occasionally there may be power interruptions due to thunderstorms or other causes. Remove the power cord from AC outlet when a power outage occurs. When power has been restored, replugin power cord to AC outlet. If outage is for a prolonged period, inspect and discard spoiled food in the refrigerator. Clean refrigerator before reusing.

Vacation and Moving Care

- For long vacations or absences, empty food from refrigerator, move the temperature DIAL to the OFF position and clean the refrigerator and door gaskets according to "General cleaning" section. Prop doors open, so air can circulate inside. When moving always move the refrigerator vertically. Do not move with the unit lying down. Possible damage to the sealed system could occur.

TroubleShooting

Refrigerator Does Not Operate

- Check if thermostat control is not in the "OFF" position.
- Check if refrigerator is plugged in.
- Check if there is power at the ac outlet, by checking the circuit breaker.
- Wait for 30-40 minutes to see whether refrigerator will start. It must complete cycle before Compressor starts to operate.

Food temperature appears too warm

- Frequent door openings.
- Allow time for recently added warm food to reach fresh food temperature.
- Check gaskets for proper seal.
- Clean condenser coils.
- Adjust temperature control to colder setting.

Food temperature is too cold

- If temperature control setting is too cold, adjust to a warmer setting and allow several hours for temperature to adjust.

Refrigerator runs too frequently

- This may be normal to maintain constant temperature during high temperature and humid days.
- Doors may have been opened frequently or for an extended period of time.
- Clean condenser coils.
- Check gasket for proper seal.
- Check to see if doors are completely closed.

Moisture build up on interior or exterior of the refrigerator:

- This is normal during high humidity periods.
- Prolonged or frequent door openings.
- Check door gaskets for proper seal.

Refrigerator has an odor:

- Interior needs cleaning.
- Foods improperly wrapped or sealed are giving off odors.

Refrigerator light does not work:

- Check power supply.
- Tighten bulb in socket.
- Replace burned out bulb.

Refrigerator door does not shut properly:

- Level the refrigerator.
- Re-align refrigerator door.
- Check for blockages e.g. food containers, crisper cover, shelves, bins etc.

Limited Warranty

What is covered and for how long?

This warranty covers all defects in workmanship or materials for a period of:

12 months labor

12 months parts

5 years sealed system

The warranty commences on the date the item was purchased and the original purchase receipt must be presented to the authorized service center before warranty repairs are rendered.

EXCEPTIONS: Commercial or Rental Use warranty

90 days labor (carry-in only)

90 days parts

No other warranty applies

What is covered.

1. The mechanical and electrical parts, which serve as a functional, purpose of this appliance for a period of 12 months. This includes all parts except finish, and trim.
2. The components of the sealed system e.g. hermetic compressor, condenser and evaporator from manufacturing defects for a period of 5 years from the date of purchase. Any damages to such components caused by mechanical abuse or improper handling or shipping will not be covered.

What will be done?

1. We will repair or replace, at our discretion any mechanical or electrical part which proves to be defective in normal usage during the warranty period so specified.
2. There will be no charge to the purchaser for parts and labor on any covered items during the initial 12 month period. Beyond this period

only parts are covered in the remaining warranty. Labor is not provided and must be paid by the customer.

3. Contact your nearest authorized service center. For the name of the nearest service center please call 1-877-337-3639

THIS WARRANTY COVERS APPLIANCES WITHIN THE CONTINENTAL UNITED STATES, PUERTO RICO AND CANADA. IT DOES NOT COVER THE FOLLOWING:

Damages from improper installation.
Damages in shipping.

Defects other than manufacturing.

Damage from misuse, abuse, accident, alteration, lack of proper care and maintenance or incorrect current or voltage.

Damage from other than household use.

Damage from service by other than an authorized dealer or service center.

Decorative trims or replaceable light bulbs.

Transportation and shipping.

Labor (after the initial 12 months).

THIS LIMITED WARRANTY IS GIVEN IN LIEU OF ALL OTHER WARRANTIES, EXPRESSED OR, INCLUDING THE WARRANTIES OF MERCHANTABILITY AND FITNESS FOR A PARTICULAR PURPOSE

The remedy provided in this warranty is exclusive and is granted in lieu of all other remedies.

This warranty does not cover incidental or consequential damages, so the above limitations may not apply to you. Some States do not allow limitations on how long an implied warranty lasts, so the above limitations may not apply to you.

This warranty gives you specific legal rights, and you may have other rights, which vary, from state to state.

Haier America
New York, NY 10018

IMPORTANT

Do Not Return This Product To The Store

If you have a problem with this product, please contact the "Haier Customer Satisfaction Center" at 1-877-337-3639.

DATED PROOF OF PURCHASE REQUIRED FOR WARRANTY SERVICE

IMPORTANT

Ne pas Réexpédier ce Produit au Magasin

Pour tout problème concernant ce produit, veuillez contacter le service des consommateurs 'Haier Customer Satisfaction Center' au 1-877-337-3639.
UNE PREUVE D'ACHAT DATEE EST REQUISE POUR BENEFICIER DE LA GARANTIE.

IMPORTANTE

No regrese este producto a la tienda

Si tiene algún problema con este producto, por favor contacte el "Centro de Servicio al Consumidor de Haier" al 1-877-337-3639 (Válido solo en E.U.A).
NECESITA UNA PRUEBA DE COMPRA FECHADA PARA EL SERVICIO DE LA GARANTIA

115V, 60 Hz

Made in China
Fabriqué en Chine
Hecho en China

Haier

Haier America
New York, NY 10018