



User Manual /
Installation Instructions
Outdoor Refrigerator Drawers

MODEL:
L24DWR



Lynx Professional Grills
5895 Rickenbacker Rd., Commerce, CA 90040
Service: (888) 289-5969
Tel: (323) 838-1770
Fax: (323) 838-1778
www.lynxgrills.com

As product improvement is an ongoing process at Lynx, we reserve the right to change specifications and design without notice.



PN: 33448

INTRODUCTION

Congratulations on your purchase of a Lynx residential refrigeration product. Lynx has taken its expertise and experience into creating the highest quality and most innovative residential products on the market. Lynx's product offering gives you the opportunity to enjoy the functionality and user friendliness outdoors, or in just about any room of your home. All Lynx products are built with commercial-grade stainless steel – providing you with the beauty and durability for a lifetime of use.

This Installation and Operation Manual will answer your questions about the features, operation and maintenance of your Refrigerated Cabinet model. If you have questions that are not addressed here, call Customer Service at 888-289-5969.

IMPORTANT

PLEASE READ all instructions completely before attempting to install or operate the unit. First, as you follow these Installation and Operation instructions, take particular note of the **DANGER!**, **CAUTION!** and **WARNING!** symbols when they appear. This information is important for the safe and efficient installation, operation and care of your Lynx unit.

DANGER

Indicates a hazard that will result in serious injury or death if precautions are not followed.

WARNING

Indicates a hazard may cause serious injury or death if precautions are not followed.

CAUTION

Indicates a hazard where minor injury or product damage may occur if you do not follow instructions.

Once the unit is completely installed, we suggest you keep this manual and purchasing documentation in a safe place for future reference. Should problems occur: refer to the troubleshooting section of this manual. The information will help you quickly identify a

problem and get it remedied. In the event you require assistance, please contact Lynx Customer Service.

PLEASE RECORD YOUR MODEL'S INFORMATION

Whenever you call to request information or service, you will need to know your model number and serial number. You can find this information on the serial and identification plate located on the inside ceiling of your unit and on the warranty registration card.

WARRANTY REGISTRATION CARD

The package containing this manual also includes your warranty information. Warranty coverage begins on the date your Lynx unit was originally purchased.

IMPORTANT NOTE: Take a moment to read through the included warranty statement and complete Registration as soon as possible to validate the registration date. An alternative method of completing the Warranty Registration can be accomplished online at www.Lynxgrills.com

If you do not return your Warranty Registration I, Lynx will use the date of sale as the first date of warranty for your new Refrigerated Cabinet. You can also provide proof of purchase to Lynx customer service at 888-289-5969. Please record the purchase date of your Lynx product and your dealer's name, address and telephone number.

MODELNUMBER: _____

SERIAL NUMBER: _____

PURCHASE DATE: _____

DEALER NAME & ADDRESS:

DEALER TELEPHONE:



TABLE OF CONTENTS

INTRODUCTION	1
PLEASE RECORD YOUR MODEL'S INFORMATION.....	1
WARRANTY REGISTRATION CARD.....	1
TABLE OF CONTENTS.....	2
GENERAL PRECAUTIONS.....	3
INSTALLATION INSTRUCTIONS	3
FIGURE 1 SPECIFICATION DRAWING.....	4
PREPARING THE SPACE.....	5
PREPARING ELECTRICAL CONNECTIONS.....	5
UNPACKING AND MOVING.....	5
ANTI-TIP-OVER INSTALLATION.....	6
INSTALLING.....	7
TOE PLATE INSTALLATION.....	8
FIGURE 3 TOE PLATE INSTALLATION.....	8
DRAWERS	10
OPERATION	11
INTERIOR LIGHT.....	11
LOADING PRODUCT.....	11
TEMPERATURE CONTROLLER.....	11
TEMPERATURE CONTROLLER ADJUSTMENTS.....	11
CHART 1 PRODUCT TEMP SET POINTS AND RANGES.....	11
CHECKING PRODUCT TEMPERATURE.....	12
MAINTENANCE	14
CLEANING.....	15
LIGHT BULB REPLACEMENT.....	15
CONDENSER CLEANING.....	15
TROUBLESHOOTING	16
WARRANTY.....	18



GENERAL PRECAUTIONS

DANGER

Risk of child entrapment, before you throw away your old refrigerator or freezer, take off the doors and leave shelves in place so that children may not easily climb inside.

DANGER

Altering, cutting of the power cord, or removal of the power cord, removal of power plug, or direct wiring can cause serious injury, fire and/or loss of property and/or life and will void the warranty.

WARNING

- Never attempt to repair or perform maintenance on the unit until the electricity has been disconnected.
- The anti-tip kit must be installed on this unit before it is used. Never use the drawers, shelves or doors as steps or to support more than they were designed to support.

CAUTION

- Do not lift unit by drawer or door handles.
- Failure to clean the condenser every three months can cause the unit to malfunction. This could void the warranty.
- Never install the unit behind closed doors. Be sure front louvered toe plate is free of obstruction. Obstructing free airflow can cause unit to malfunction,

and may void the warranty.

CAUTION

Use only genuine Lynx replacement parts. Imitation parts can damage the unit, and may void the warranty.

INSTALLATION INSTRUCTIONS

General

- All electrical instructions assume that outlet is located 4 to 10 inches from the floor
- Floor must be level in area of installation. Leg levelers are used for fine-tune adjustment only and should not be used to compensate for floor differences exceeding 1/2-inch.
- When moving unit into position, take care to protect floor surface with cardboard, rugs, etc.
- Never attempt to move unit without the aid of at least one other person.
- Always secure door shut prior to moving the unit

Finished Opening Requirements

- Height: 34-3/8" minimum
35-1/2" maximum
- Depth: 24"
- Width: 24"

50" Area in which electrical outlet must be located

$7\frac{9}{16}"$ Power chord 6- $7\frac{1}{16}"$ off floor. **

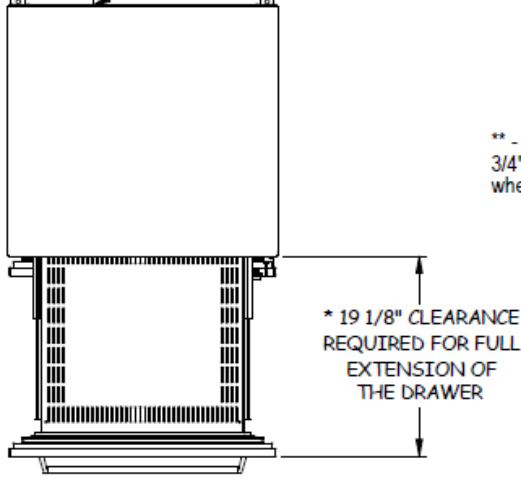

** - Leg levelers can add $\frac{3}{4}"$ to these dimensions when fully extended

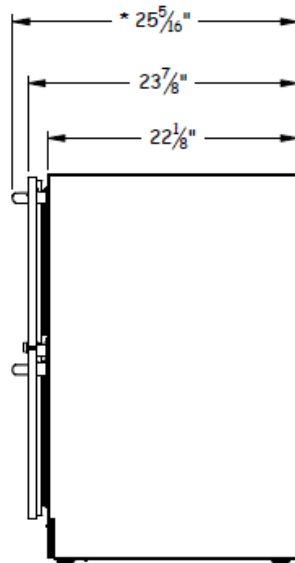
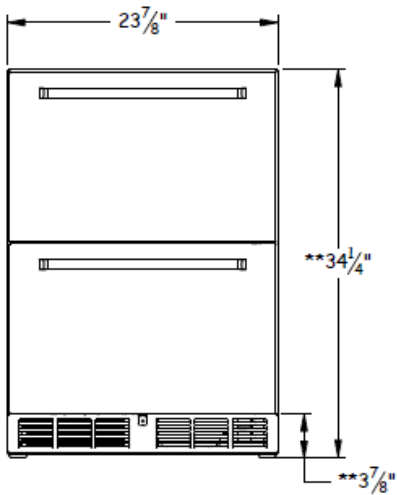
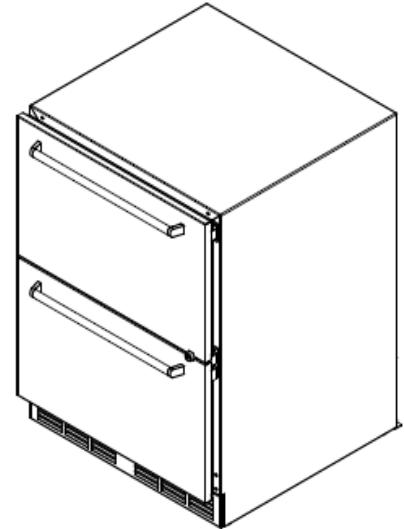

* - Values may change due to custom pull with a wood overlay door

Figure 1. Dimensions



PREPARING THE SPACE

Make sure that the opening where the unit is to be installed is properly prepared. Refer to Figure 1 to ensure the space dimensions and electrical service are correct for the models to be installed.

CAUTION

If unit is being installed under a counter top it is recommended that the counter top be supported by structure other than the refrigerated cabinet to prevent damage to the counter top.

IMPORTANT NOTE: Allow 24" clearance in front of the unit for drawer pull-out.

IMPORTANT NOTE: Make sure the floor under the unit is level with the surrounding finished floor. Protect a finished floor with plywood, cardboard or some other suitable material before moving the unit into place. Failure to do this may result in damage to the floor.

PREPARING ELECTRICAL CONNECTIONS

A 115 volt, 60Hz, 15 amp circuit with GFI protection and electrical supply are required. A separate circuit is required for each Lynx unit installed.

Follow the National Electrical Code and local codes and ordinances when installing the receptacle.

All Lynx units come equipped with a NEMA 5-15P 90° plug with a minimum of 5-feet of cord extending beyond the rear of the cabinet. The electrical outlet must be flush with or recessed into the back wall.

IMPORTANT NOTE: Never use an extension cord to extend the power cord to the electrical receptacle.

DANGER

ELECTROCUTION HAZARD!!

Electrical grounding required. This appliance is equipped with a three prong (grounding) polarized plug for your protection against possible shock hazards.

- Never remove the round grounding prong

- from the plug.
- Never use a two-prong grounding adapter.
- Never use extension cord to connect power to the unit.

Where a two-prong wall receptacle is encountered or a longer power cord is required, contact a qualified electrician to have it replaced in accordance with applicable electrical codes.

DANGER

Failure to comply with the above electrical guidelines may result in possible injury/death/fire or loss of property.

UNPACKING AND MOVING

CAUTION

Do not cut cardboard sleeve covering the unit. Cutting may result in damage to the exterior of the cabinet.

1. Uncrate the unit outside on a flat level surface. Remove the cardboard sleeve by removing the banding holding the sleeve to the shipping base. Carefully lift the cardboard sleeve up over the top of the unit.
2. Carefully lift unit off base and onto a hand truck or dolly (this should be done with a minimum of two people; larger units may require additional helpers). Make sure unit is balanced on transporting device. Secure unit to transporting device using soft, flexible strapping. Protect unit surfaces with cloth material where strapping contacts unit.
3. Before moving unit, secure door to unit with tape to the door closed.
4. Carefully move unit to installation site and place in front of opening.

WARNING

A minimum of two people should lift the unit of the base to prevent possible personal injury.



ANTI-TIP BRACKETS

Figure 2. TWO-DRAWER ANTI-TIP LAYOUT

WARNING

Unit may tip forward when drawers are loaded and pulled to open position. To provide a stable installation, the unit must be secured in place

with the anti-tip brackets provided with the unit. A set of metal anti-tip brackets are supplied with the unit. The anti-tip brackets, when properly installed should secure the rear legs and prevent the unit from tipping forward.

Some installation sites may require modification to provide a secure surface for attaching the brackets. bracket locations

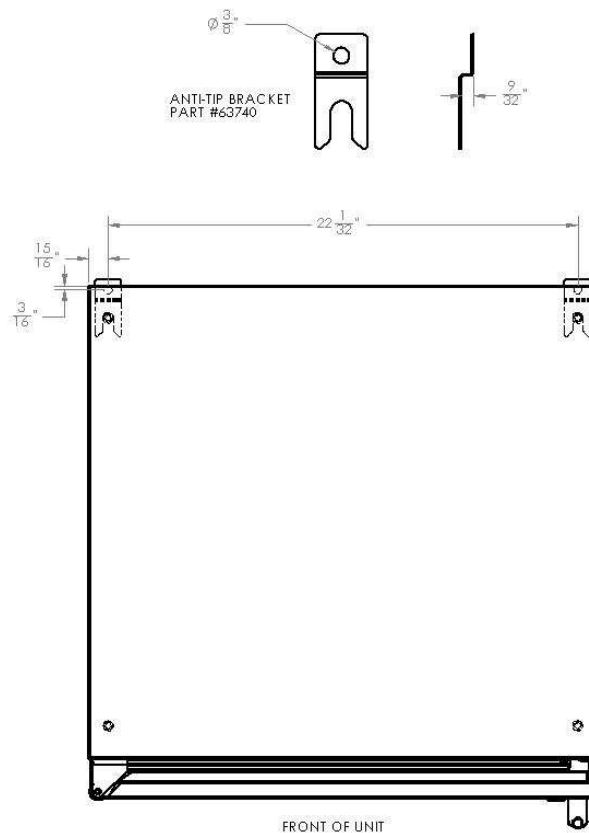



INSTALLATION

IMPORTANT NOTE: If installing on a concrete floor, concrete fasteners are required and not included with the anti-tip kit.

CAUTION

Any finished flooring should be protected with appropriate material to avoid damage from moving the unit.

If unit has been laid on its back or sides, place unit upright and allow minimum of 24 hours before connecting power.

1. Plug the unit into the 15 amp grounded GFI outlet located in the installation opening. With power applied to the unit, check that the lighting and cooling function operate properly, then turn off power to the wall outlet at the circuit breaker.

WARNING

Shut off power to the wall outlet before installing into the opening.

2. Check that the following are level and square:
 - Front face and interior opening
 - Installation opening and floor surface
 - Countertop bottom front edge

IMPORTANT NOTE: Leveling legs should not be extend more than $\frac{3}{4}$ " from bottom of the cabinet.

IMPORTANT NOTE: The floor under the unit must be at the same level as the surrounding finished floor.

3. If all surfaces are level:
 - a. Measure from the floor to the bottom of the front edge of the countertop
 - b. Measure the rear of the unit cabinet from the floor to top of cabinet, at back corners
 - c. Adjust rear legs so B measurement equals A measurement. Using an adjustable wrench or pliers, turn legs counterclockwise to raise the unit or clockwise to lower the unit
4. Slide the unit into position, making sure the rear cabinet leveling legs slide under the

anti-tip devices. Push the unit into the opening until the bottom front edge of the cabinet is flush with the surrounding cabinetry or the leveling legs are tight with the anti-tip devices.

IMPORTANT NOTE: The rear cabinet leveling legs must be engaged under the anti-tip brackets.

5. Shim the front of the unit so the front face is flush with surrounding cabinetry. Adjust the front legs to support the countertop at the shimmed height. Using an adjustable wrench or pliers, turn legs counterclockwise to raise the unit or clockwise to lower the unit. Countertop should be resting on top of the unit.

IMPORTANT NOTE: If countertop is not resting entirely on unit top, shim the countertop to prevent damage to the countertop.

CAUTION

To prevent damage to the countertop and unit underneath, do not place heavy objects on countertop directly above the unit.

6. Re-install all drawers. Take extreme care to insert sliding drawers squarely into slide brackets and proper slide bracket grooves. When drawers are installed properly a click should be heard from both slide bracket retaining clips and should slide smoothly in the tracks. When drawers are pulled out to full extension a stop is activated to prevent additional pull-out.

CAUTION

Improper drawer installation may not actuate slide stop mechanism.



TOE PLATE INSTALLATION

When the unit is secured in place, install the louvered toe plate. Secure louvered toe plate by snapping the latch into the latch catch on the unit.

Refer to Figure 3 TOE-PLATE INSTALLATION ILLUSTRATION

CAUTION

The louvered toe plate must be removable for servicing. The floor cannot interfere with removal. The louvered sections of the toe plate must not be covered or obstructed so as to prevent proper air circulation.

Figure 3. TOE PLATE INSTALLATION.

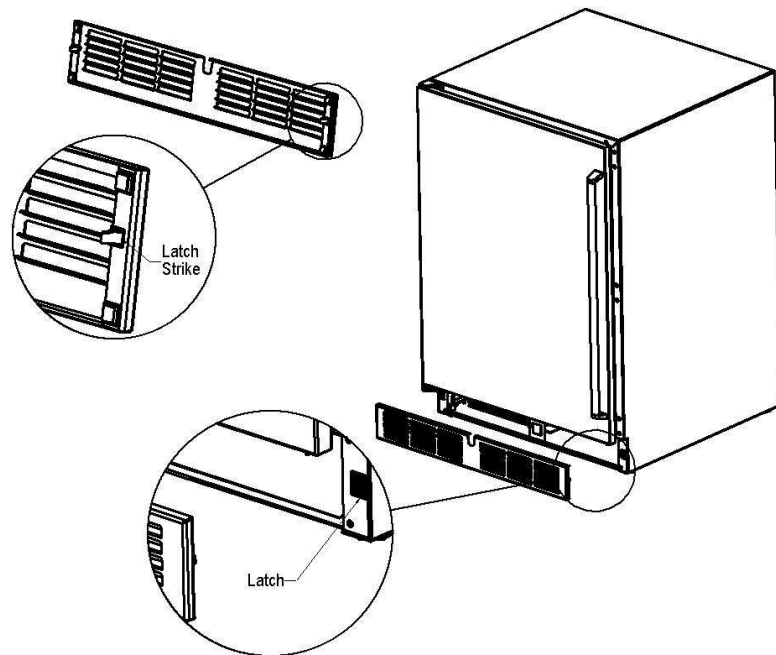



Drawers

IMPORTANT NOTE: Interior louver openings and fan guard openings should never be obstructed to achieve maximum performance.

IMPORTANT NOTE: All shelving is interchangeable with all products.

Drawers

Full-extension Drawers – Pull the drawer out to its farthest point. Locate the tabs in the middle on both sides of the extenders. Press left tab up and right tab down; pull shelf out.

Move each extender separately. Hold the middle of one extender, pull the front up then move extender ½-inch to the inside of unit. Pull up then pull out. Place extender at desired height, place rear standoff screw into rear pilaster, slide back. Place front standoff screw into front

pilaster, slide down.

To return drawer, first push both extenders completely in then line up the shelf grooves and slide easily into the unit.

CAUTION completely empty the drawer before removing



OPERATION

The Lynx L24DWR comes equipped with a state of the art refrigeration system. The compressor is of a variable speed variety, which automatically changes speeds based on system conditions and load. The cabinet is equipped with an adjustable digital temperature controller and LED display.

The freezer is a frost-free model meaning the evaporator (cooling coil) automatically defrosts on demand at predetermined intervals. The controller also has a manual defrost soft button on the front panel signified by a melting snowflake. If depressed it will automatically put the system into a defrost cycle.

Interior light

The unit is equipped with an interior light that is illuminated when the door is opened. The cabinet also comes standard with a manual light switch located next to the light for displaying your products through a glass door. Always ensure that the manual switch is in the off position before closing a solid wood or stainless steel door. If manual light switch is left on for an extended period of time it may increase the cabinet temperature, especially at the top and cause the refrigeration system to run longer.

Loading Product

IMPORTANT NOTE: Before storing perishables, allow unit to run for a minimum of 24 hours to allow temperature stabilization after start-up.

When loading items into unit, do not block internal louvers and fan guard openings or performance will be decreased.

Temperature Control Panel

The controller is located inside of the unit. The display will read OFF when unit off and will show temperature when unit is on.

IMPORTANT NOTE: the led display is reading actual air temperature not product temperature. Under these conditions, an air temperature swing does not change the actual product temperature. Product temperature remains at a very stable temperature.

**Freezer:
Refrigerator**

**10° swing
6° swing**

Temperature Control Panel

The controller is located inside of the unit. The display will read OFF when unit off and will show temperature when unit is on.

TEMPERATURE CONTROLLER





SET: To display target set point; in programming mode it selects a parameter or confirm an operation.

 **(DEF)** To start a manual defrost



 **(UP)**: To see the max. stored temperature; in programming mode it browses the parameter codes or increases the displayed value.

 **(DOWN)** To see the min stored temperature; in programming mode it browses the parameter codes or decreases the displayed value.

 To switch the instrument off, if onF = oFF.

 Not enabled







KEY COMBINATIONS:

 +  To lock & unlock the keyboard.

SET +  To enter in programming mode.

SET +  To return to the room temperature display.

Each LED function is described in the following table.

LED	MODE	FUNCTION
	ON	Compressor enabled
	Flashing	Anti-short cycle delay enabled
	ON	Defrost enabled
	ON	An alarm is occurring
	ON	Continuous cycle is running
	ON	Energy saving enabled
°C/°F	ON	Measurement unit
°C/°F	Flashing	Programming phase

5.1 HOW TO SEE THE MIN TEMPERATURE

1. Press and release the ▼ key.
2. The "Lo" message will be displayed followed by the minimum temperature recorded.
3. By pressing the ▼ key again or by waiting 5s the normal display will be restored.

5.2 HOW TO SEE THE MAX TEMPERATURE

1. Press and release the ▲ key.
2. The "Hi" message will be displayed followed by the maximum temperature recorded.
3. By pressing the ▲ key again or by waiting 5s the normal display will be restored.

5.3 HOW TO RESET THE MAX AND MIN TEMPERATURE RECORDED

1. Hold press the SET key for more than 3s, while the max. or min temperature is displayed. (rSt message will be displayed)
2. To confirm the operation the "rSt" message starts blinking and the normal temperature will be displayed.

6.1 HOW TO SEE THE SETPOINT



1. Push and immediately release the **SET** key: the display will show the Set point value;
2. Push and immediately release the **SET** key or wait for 5 seconds to display the probe value again.

6.2 HOW TO CHANGE THE SETPOINT

1. Push the **SET** key for more than 2 seconds to change the Set point value;
2. The value of the set point will be displayed and the "°C" or "°F" LED starts blinking;
3. To change the Set value push the ▲ or ▼ arrows within 10s.
4. To memorise the new set point value push the **SET** key again or wait 10s.

6.3 HOW TO START A MANUAL DEFROST



1. Push the **DEF** key for more than 2 seconds and a manual defrost will start.



6.6 HOW TO LOCK THE KEYBOARD

1. Keep pressed for more than 3 s the **UP + DOWN** keys.
2. The "POF" message will be displayed and the keyboard will be locked. At this point it will be possible only to see the set point or the MAX o Min temperature stored
3. If a key is pressed more than 3s the "POF" message will be displayed.

6.7 TO UNLOCK THE KEYBOARD

Keep pressed together for more than 3s the ▲ and ▼ keys, till the "Pon" message will be displayed.

6.9 THE ON/OFF FUNCTION



With "onF = oFF", pushing the **ON/OFF** key, the instrument is switched off. The "OFF" message is displayed. In this configuration, the regulation is disabled.
To switch the instrument on, push again the **ON/OFF** key.

IMPORTANT NOTE: Dependent on the model and configuration, the controllers have been programmed to only allow a temperature adjustment within a specified range (see chart below for the specified range allowed for your cabinet).

CHART 1. PRODUCT TEMPERATURE SET POINTS AND RANGES.

Two Door Refrigerator/Beverage Center (HP48RB)

Refrigerator Section	38°F	Range: 33°F to 43°F
Beverage Center Section	42°F	Range: 36°F to 48°F

IMPORTANT NOTE: All multi-zone models must have a minimum of 8 degrees difference between zones



CHECKING PRODUCT TEMPERATURE

To accurately check the temperature of the product stored in a refrigerated compartment, insert an accurate thermometer into a plastic (non-breakable) bottle, partially filled with water. Tighten the bottle cap securely.

Place the bottle in the desired area for 24 hours. Refrain from opening the unit during the testing period. After 24 hours, check the temperature of the water. Adjust the control settings if necessary and re-test.

Your Lynx units are pre-set in order to achieve the recommended temperature range when installed in a 70°F ambient room temperature. Factors, which affect the internal temperatures of the refrigerated cabinet, include:

- Temperature setting
- Room temperature where installed
- Number of times the door is opened and closed
- Length of times the door is opened and closed
- Length of times the door is left open
- Style of door installed
- Door gasket sealing and condition
- Amount of time the internal light is illuminated
- Installation in direct sun light or near a heat source

LIGHT BULB REPLACEMENT

To replace a defective or burnt out light bulb, unscrew the bulb counterclockwise and replace with an identical 15-Watt bulb or smaller. Contact Lynx for a replacement bulb.

MAINTENANCE

CLEANING

To clean stainless steel exterior or interior surfaces, use a soft, non-abrasive stainless steel cleaner to wipe down these surfaces.

To clean interior and exterior non-metallic surfaces and removable parts, wash with a mild solution of soap and lukewarm water with a little baking soda. Rinse and dry thoroughly. Avoid getting water on lights, controllers, fan motors, and unfinished wood wine rack faces.

CAUTION

Do not use abrasive cleaners or cloths on any of the interior or exterior surfaces or removable parts.

CONDENSER CLEANING

WARNING

For cleaning the condenser and other routine maintenance, shut off electricity to the unit.

In all instances, you should clean the condenser area every three months. The condenser is located behind the louvered toe plate. To clean the condenser remove the toe plate and use a soft bristle brush and vacuum to remove dust and lint. Avoid damaging or crushing the condenser fins or tubing. Upon completion, re-install the louvered toe plate.

CAUTION

Failure to clean the condenser could result in temperature loss or mechanical failure or damages. Clean this area every three months.



TROUBLESHOOTING

BEFORE CALLING FOR SERVICE

If the unit appears to be malfunctioning, read through NORMAL OPERATION first. If the problem persists, check the TROUBLESHOOTING GUIDE. Locate the problem in the guide and refer to the cause and its remedy before calling for service. The problem could be something, which can be solved without a service call.

GENERAL TROUBLESHOOTING

DANGER

ELECTROCUTION HAZARD!!

NEVER ATTEMPT TO REPAIR OR PERFORM MAINTENANCE ON THE UNIT UNTIL THE MAIN ELECTRICAL POWER HAS BEEN DISCONNECTED.

No interior light

- Is the bulb loose?
- Is the bulb burned out?

Light stays on when door is closed

- Manual ON/OFF light switch is turned ON.
- Is the door switch making contact with the door?

Noise during operation

- Certain sounds are normal. Soft sounds from the compressor, fan motor and valves will be heard.
- During freezer defrost crackling is normal.

Controller display is flashing "P1"

- There is a thermostat probe failure.

Controller display is flashing "P2"

- There is an evaporator probe failure.

Controller display is flashing "HA"

- The internal compartment temperature has exceeded the high temperature alarm preset value for over 30 minutes.
- Check to ensure door is closed.
- Check for door gasket seal.
- Did you just install warm product?
- Is the condenser clean?
- Is the louvered toe plate obstructed?
- Has the surrounding ambient temperature changed dramatically?
- Is the interior light ON?

Controller display is flashing "LA"

- The internal compartment temperature has exceeded the low temperature alarm preset value for over 30 minutes.
- Check to ensure door is closed.
- Check for door gasket seal.
- Has the surrounding ambient temperature changed dramatically?

Controller display is flashing "EE"

- The controller has a data or memory failure

The refrigerated cabinet isn't running

- Is there electrical power to the unit?
- Is your home circuit breaker or fuse on?
- Is your ON/OFF key pad on?
- Is your condenser area clean?



The refrigerated compartment is warmer than usual

- Is your control set properly?
- Is the light staying on?
- Is your condenser area clean and free of obstructions?
- Has the door been open for a long time or more frequent door openings occurred?
- Are the internal louvers and fan guard openings obstructed?
- Has warm product just been placed in the cabinet?

The refrigerated compartment is colder than usual

- Is your control set properly?
- Is your door closing and sealing properly?
- Is the ambient temperature within the normal operating range?

The refrigeration system runs for long periods of time

- Is the condenser area clean and free of obstructions?
- Have the doors been open for a long time or more frequent door openings occurred?
- Have warm product just been placed in the cabinet?
- On hot days and in warm room temperatures the system will run long.

Condensation forms inside the refrigerated compartments

- This is normal during high humidity and frequent door openings.
- Are the doors closing and sealing properly?

Condensation forms on the outside of the unit

- During periods of high humidity some condensation might appear on outside surfaces. The condensation will disappear when the humidity drops. Meanwhile, be sure doors are closing and sealing properly. If condensation persists, contact your Lynx Factory Authorized Service Center.

You need product information

- Contact Lynx Grills
- Inquire via the WEB at www.Lynxgrills.com
- Call 888-289-5969 for factory assistance for information, installation or product information.
- Write to: Lynx Corporation, Customer Service Department, 5895 Rickenbacker Rd., Commerce CA 90040
- or e-mail us at info@lynxgrills.com

You need product service

- Check the model and serial number of your unit located on the label attached to the inside top of the cabinet. For the location of the Service Center in your area, contact your dealer, inquire via the WEB at www.Lynxgrills.com, or write to: Lynx Professional Grills, Customer Service Department, 5695 Rickenbacker Road, Commerce, CA 90040, call 888-289-5969 or e-mail us at www.Lynxgrills.com.

You need replacement parts or accessories

- Use only genuine Lynx replacement parts and accessories. Genuine Lynx parts and accessories are designed to work correctly with Lynx products and offer superior service life. The use of non-Lynx parts can damage the unit and may void the warranty
- Check the model and serial number of your unit located on the label attached to the inside top of the cabinet. For the location of the Service Center in your area, contact your dealer, inquire via the WEB at www.Lynxgrills.com, or write to: Lynx Professional Grills, Customer Service Department, 5695 Rickenbacker Road, Commerce, CA 90040, call 888-289-5969 or e-mail us at www.Lynxgrills.com.



WARRANTY

One Year Parts and Labor Warranty:

For one year from the date of original purchase, within the United States and Canada, when used and maintained according to instructions, Lynx Grills warranty covers all parts and labor to repair or replace any part of the product, which proves to be defective in material and workmanship.

Four Year Additional Compressor Warranty:

Lynx will warrant to the original user the sealed-in mechanism consisting of the motor compressor and component parts within the sealed housing of the condensing unit for an additional period of four years following the regular one-year warranty period. This plan applies to the compressor only, installed within the United States and Canada.

TERMS:

All service provided by Lynx under the above warranty must be performed by authorized Lynx service representatives, unless otherwise specified by Lynx.

Service will be provided in the home during normal business hours.

This warranty applies only to products installed for normal residential use; it does not include adjusting the controls, door reversal, light bulb or cleaning the condenser.

This warranty is extended only to the original purchaser of the Lynx product.

The above warranty does not apply if:

- Failure of product was due to transportation
- Product was: improperly installed, misused, abused, operating with low voltage, wiring not conforming electrical codes, improperly maintained or modified.
- The original Bill of Sale, delivery date or serial number cannot be verified.
- Defective parts are not returned for inspection if so required by the Lynx.

To receive parts and or service and the name of the nearest Lynx authorized service representative, contact Lynx Professional Grills Technical Service Department via the WEB at www.Lynxgrills.com, or write to: Lynx Professional Grills, Customer Service Department, 5695 Rickenbacker Road, Commerce, CA 90040, call 888-289-5969 or e-mail us at service@Lynxgrills.com.

Warranty is in lieu of any other warranties, expressed or implied and all other obligations or liabilities related to the sale or use of its refrigeration products, including, but not limited to any implied warranty of merchantability or fitness for a particular purpose; provided however, that to the extent required by law, implied warranties are included but do not extend beyond the duration of the express warranty first set above. Lynx's sole liability and your exclusive remedy under this warranty are set forth in the initial paragraph above. Lynx shall have no liability whatsoever for any incidental, consequential or special damages arising from the sale, use or installation of the product or from any other causes whatsoever, whether based on warranty (expressed or implied) or otherwise based on contract, tort or any other theory of liability.

Some states do not allow limitations on how long an implied warranty lasts or the exclusions of or limitation of incidental or consequential damages, so the above limitations may not apply to you. This warranty gives you specific legal rights, and you may also have other rights, which vary, from state to state.



PROFESSIONAL GRILLS

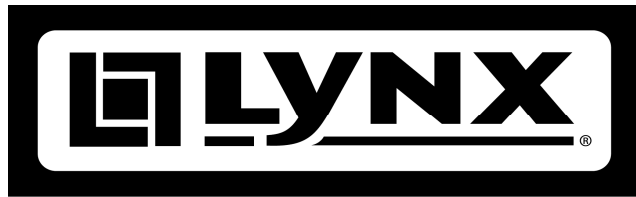

5895 Rickenbacker
90040 • 888-289-5969

PROFESSIONAL GRILLS

www.lynxgrills.com

Road • Commerce, CA
• Fax 323-838-1778 •