

USE & CARE GUIDE



Convection Steam Oven



## Contents

Wolf Convection Steam Oven . . . . .	3
Safety Instructions . . . . .	4
Convection Steam Oven Features . . . . .	7
Convection Steam Oven Operation . . . . .	10
Convection Steam Oven Cooking Modes . . . . .	17
Convection Steam Oven Care . . . . .	35
Troubleshooting Guide . . . . .	40
Service Information . . . . .	42
Wolf Warranty . . . . .	43

Features and specifications are subject to change at any time without notice. Visit our website, [wolfappliance.com](http://wolfappliance.com) for the most up-to-date information.

**IMPORTANT NOTE:** Throughout this guide, dimensions in parentheses are millimeters unless otherwise specified.

## Important Note

To ensure the safe and efficient use of Wolf equipment, please take note of the following types of highlighted information throughout this guide:

**IMPORTANT NOTE** highlights information that is especially important.

**CAUTION** signals a situation where minor injury or product damage may occur if instructions are not followed.

**WARNING** states a hazard that may cause serious injury or death if precautions are not followed.



## Welcome

Congratulations on your choice of a Wolf convection steam oven.

The legacy of the “combination oven” goes back decades, to innovative restaurant chefs in America and Europe who embraced the gentle combination of air movement with superheated steam to achieve superior results in menu offerings from breads and roasts to delicate fishes, seafood and vegetables.

European home cooks wanting the highest degrees of freshness, flavor and vitamin preservation for their families also embraced the technology, and today the home steam oven is a standard fixture of the residential kitchen in many European countries.

Now Wolf combines the benefits of convection heat and steam heat for the most innovative home steam oven on the market today. Virtually any dish prepared in a conventional oven, range or microwave can also be prepared in the Wolf convection steam oven—with more control over the finished product. The convection movement of hot air ensures consistent heating and browning and eliminates odor transfer while steam adds moisture at just the right times and amounts—for the perfect end results.

- Moistness and flavor are retained so no additional oil, basting or sauces are necessary.
- Vitamins, texture, shape, size and color are preserved.
- Risks of overcooking are reduced and messy boil-overs eliminated.
- Breads, bagels, bakery and pastry can be proofed, baked and crisped with steam.
- Meats defrost gently and evenly without any hot spots.
- In Wolf gourmet mode, a sensor automatically adjusts cooking time to the type and amount of food being cooked, preventing under- or overcooking.
- Smart timer functions are like an extra pair of hands, cooking food that’s ready to serve when you need it—even when you’re not in the kitchen to start and stop the oven.

The more you use your Wolf convection steam oven, the more you will reap these and many more benefits.

Enjoy greater confidence in the kitchen with more ease and professional results than ever before. This guide has been thoughtfully arranged to help you to learn the features and benefits of your new oven, and to be as enjoyable and productive as possible. Please read it, keep it handy for reference and follow the following safety precautions.

## SAFETY PRECAUTIONS

This oven was built to achieve recognized standards in technology and safety regulations and is designed for use in the home for preparing food. It is not intended for use by persons with reduced physical, sensory or mental capabilities, or lack of experience and knowledge, unless supervised or unless they have been given instruction concerning the use of the appliance by a person responsible for their safety. Proper use is essential to avoid damage or accidents.

Installation and connection to power supply must be performed by a qualified electrician in accordance with provided installation instructions.

Before first use, please fill the water tank and perform related duties as outlined in the 'Using for the first time' section.

Please retain this guide for future reference. If you sell the appliance or pass it on to a third party, please ensure these instructions accompany the appliance, together with the instructions on installation.

## IMPORTANT SAFEGUARDS

When using electrical appliances, basic safety precautions should always be followed including the following:

- Read all instructions.
- Do not touch hot surfaces. Use handles or knobs.
- To protect against electrical shock, do not immerse cord or plug in water or other liquid.
- Close supervision is necessary when any appliance is used by or near children.
- Unplug from outlet when not in use and before cleaning. Allow to cool before putting on or taking off parts.
- Do not operate any appliance with a damaged cord or plug, or after the appliance malfunctions or has been damaged in any manner. Return appliance to the nearest authorized service facility for examination, repair or adjustment.
- The use of accessory attachments not recommended by the appliance manufacturer may cause injuries.
- Do not use outdoors.
- Do not let cord hang over edge of table or counter, or touch hot surfaces.
- Do not place on or near a hot gas or electric burner, or in a heated oven.
- Extreme caution must be used when moving an appliance containing hot oil or other hot liquids.
- Always attach plug to appliance first, then plug cord into the wall outlet. To disconnect, turn any control to "off", then remove plug from wall outlet.
- Do not use appliance for other than intended use.
- Save these instructions.

## SAFETY PRECAUTIONS

### CHILD SAFETY

- Plastic and polystyrene can be dangerous for children. Keep these packaging materials away from children.
- The appliance is designed for use by adults who are familiar with these operating instructions. Children are often unable to recognize the danger of electrical appliances. Ensure proper supervision and do not allow children to play with the appliance.
- Use the childproof locking feature outlined on page 9.

### FIRE HAZARDS

- Never flambé or cook food using excessive fats.
- Never use the appliance to dry animals, textiles or paper.
- Do not use the oven as a room heater or humidifier.
- Only use the probe supplied. Do not submerge it in water or clean it in the dishwasher.
- Installation and operation should only occur in a room with an ambient temperature between 41°F and 95°F. If frost develops, residual water left in the pumps could freeze and cause damage.
- Any repairs, modifications or manipulations to the appliance, especially any electrically live parts, should only be carried out by the manufacturer, its customer service department or similarly qualified persons. Incorrectly done repairs may cause serious injury, damage the appliance and fittings, and affect the functioning of the appliance.
- If the appliance is not working properly or in case a repair is needed, follow the instructions given in the troubleshooting guide. Please contact Wolf customer care if necessary.
- Only original equipment manufacturer parts may be used.
- If the appliance is visibly damaged, do not use it. Contact Wolf customer care.
- If the appliance is not operating properly, disconnect it from the power supply immediately.

## SAFETY PRECAUTIONS

### FIRE HAZARDS

- Ensure the main cables of other electrical appliances do not get caught in the door of the oven, which could damage the electrical cable insulation and create a fire hazard.
- If the main cable of the appliance is damaged it must be replaced by a Wolf factory certified service provider.
- Ensure there are no foreign bodies in the cooking space before closing the appliance door.
- Never store objects in the cooking space. This could pose a danger if the appliance were accidentally turned on. Do not store food, temperature-sensitive or inflammable materials (e.g. cleaning agents, oven sprays, etc.) in the cooking space.
- Overheated fat and oil can easily catch fire. Heating oil in the cooking space to sear meat is dangerous and should not be done. Never try to extinguish burning oil or fat with water. Smother fire or flame or use dry chemical or foam-type extinguisher.
- Do not pour spirits (e.g. brandy, whisky, schnapps, etc.) or extracts with alcohol or over hot food.
- Do not leave the appliance unsupervised when drying herbs, bread, mushrooms, etc. If the foodstuff dries out too much it can pose a fire hazard.
- If you notice smoke possibly coming from the appliance itself or from inside the cooking space, keep the appliance door closed. Disconnect the appliance from the power supply.
- Do not heat unopened food containers as build-up of pressure may cause the container to burst and result in injury.

### BURN HAZARDS

- The appliance gets very hot when in use. The oven door, especially the glass, can also get hot. Do not touch the oven door. Keep children away.
- The appliance will remain hot for some time after it is turned off and will cool down slowly to room temperature.
- Steam may escape from the cooking space when the door is opened. Do not put your hands into the cooking space if there is steam inside of it.
- Water in the water tank can be hot and can present a scalding hazard.
- Keep oven vent ducts unobstructed.
- Hot steam may escape from the steam vent during operation. Use care when opening the door to allow steam to escape before removing or replacing food.
- Accessories get hot in the cooking space. Always wear dry oven mitts or other dry, protective gloves or use oven cloths.
- Do not put fingers in the door hinges, which could cause injury if the appliance door is moved. Particular care should be taken when children are around.
- Only leave the appliance door open in the at-rest position. An open appliance door poses a danger of tripping or injury. Do not sit or rest on the appliance door or use it as a storage surface.



### Convection Steam Oven Features

- Stainless steel with tubular handle.
- Can be installed in a standard or flush inset application.
- Stainless steel trim to match L series and E series ovens.
- Convection with twelve cooking modes: steam, reheat, auto steam bake, convection, convection humid, convection steam, Wolf gourmet, slow roast, recipes, my recipes, keep warm, descale and cleanse.
- Four-level rack guides with two adjustable oven racks.
- Large viewing window and halogen interior lighting.
- Temperature probe.
- Recipes mode.
- Delayed start feature and descaling program.
- Agency certified for US and Canada.
- Two and five year residential warranty—exclusions apply, see warranty at the end of this guide.

The Wolf convection steam oven has been developed for the highest levels of quality and ease of use. For best results please take a moment to familiarize yourself with the oven’s composition, components and accessories.

#### OVEN COMPONENTS

- Two wire oven racks.
- One perforated 17<sup>3</sup>/<sub>4</sub>" x 1" x 15" stainless steel pan.
- One solid 17<sup>3</sup>/<sub>4</sub>" x 1" x 15" stainless steel pan.
- Water tank with lid.
- Temperature probe.

#### OPTIONAL ACCESSORIES

- 30" (762) L and E series stainless steel trim—framed and unframed.
- Perforated stainless steel pans—12<sup>3</sup>/<sub>4</sub>" x 1<sup>1</sup>/<sub>2</sub>" x 7" and 12<sup>3</sup>/<sub>4</sub>" x 2<sup>1</sup>/<sub>2</sub>" x 7".
- Solid stainless steel pans—12<sup>3</sup>/<sub>4</sub>" x 1<sup>1</sup>/<sub>2</sub>" x 7" and 12<sup>3</sup>/<sub>4</sub>" x 1<sup>1</sup>/<sub>4</sub>" x 14".
- Oven rack.
- Descaling solution.

### CONVECTION STEAM OVEN

Model CSO24 shown with E series unframed trim.

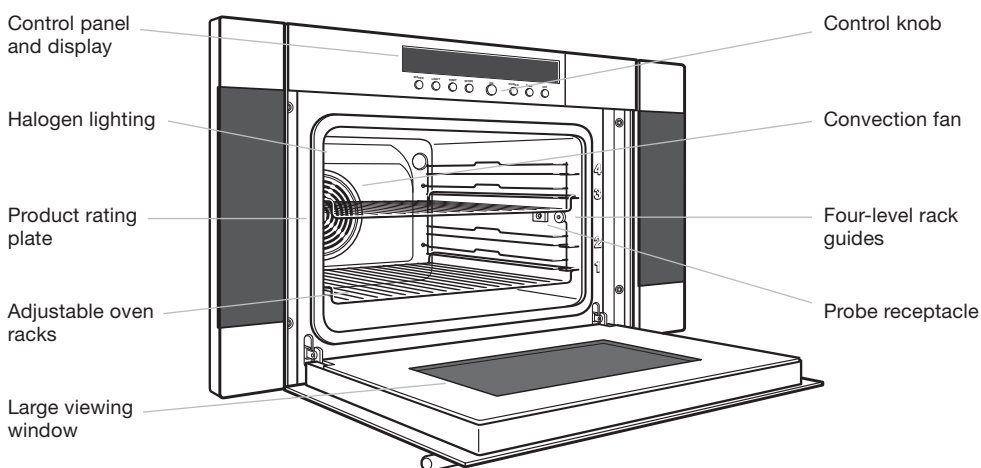

## Display and Control Panel

The display and control panel is streamlined and easy to use. The control knob and buttons are used to set the cooking modes and access all of the features of your convection steam oven for exceptional results.

### DISPLAY AREA

The convection steam oven has one display window with three separate displays providing different information. The left digital display shows cooking temperature and probe setpoint. The center text display is the informational readout used for setting different modes and cooking functions. The right digital display is the clock, timer and delayed time display.

In the lower part of the display area, symbols representing temperature, probe, cooking functions and time settings will illuminate when in use.

### CONTROL BUTTONS

The control knob (OK) and buttons, including WATER, LIGHT, TEMP, MODE, TIMER, TIME and OFF allow you to open the water tank, light the interior and select operating modes, temperatures and timing functions.

### CONTROL KNOB

The control knob (OK) is used on its own or with the control buttons to make selections. It is used to confirm any selection. You will always end a selection by pressing the control knob to confirm.

The knob's press and turn action puts every option at your fingertips. Used on its own, the control knob provides direct access to user settings and cooking modes.

#### Example using the control knob:

- 1) Press the control knob. Turn 5 clicks to user settings and press to select.
- 2) Turn to the setting you wish to personalize and press to select.
- 3) Turn to your preference and press to select. Back will return you to the previous menu.

#### Example using the control knob with the control buttons:

- 1) Press the MODE button three times to select auto steam bake. The auto steam bake  symbol illuminates. A recommendation for temperature flashes in the digital display.
- 2) Turn the control knob to select the temperature for this mode and press to confirm. Settings will be automatically accepted after ten seconds. Additional settings or changes can be made at any time.

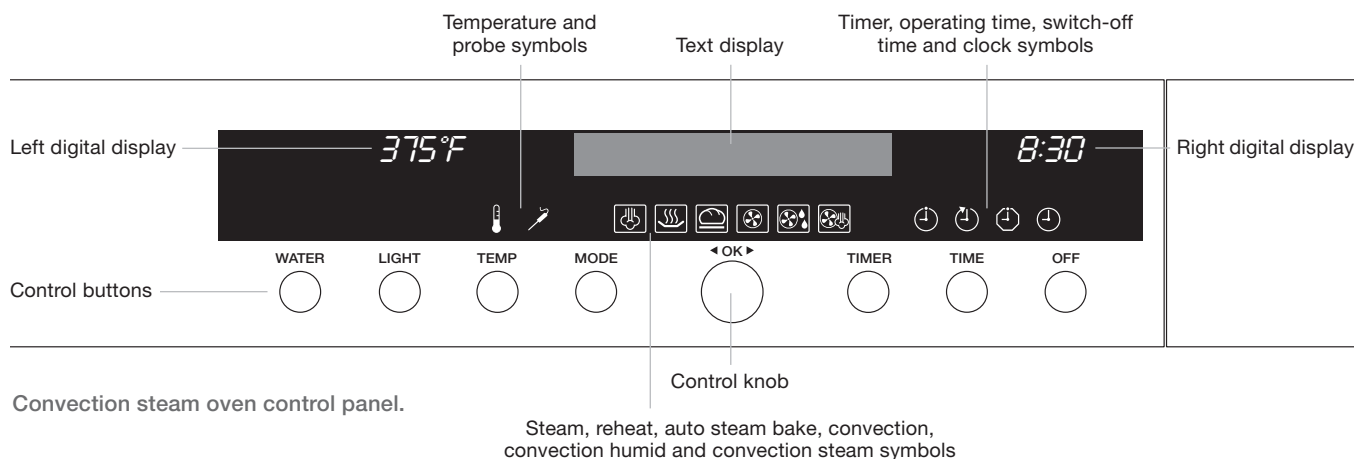



## Personalization

Now let's take a moment to personalize your oven to suit your needs and preferences. Turn the control knob to user settings to make your selections.

### LANGUAGE

**English, French or Spanish.** Turn the control knob until the desired language is displayed. Press to confirm your selection.

### CHILDPROOF LOCK

To activate or deactivate childproof lock mode, turn the oven off, then press the control knob. Turn the knob to user settings and press to select. Turn to childproof lock and press to select. Press to select on or off.

To use the oven by temporarily disabling the lock, simply press and hold the OFF button while pressing MODE and the control knob. The lock will automatically reactive ten minutes after the oven has been off.

### TIME DISPLAY

**Visible or invisible.** Invisible mode minimizes power consumption while the oven is off. The time display will disappear in approximately one minute.

### ACOUSTIC SIGNAL

**High, low or off.**

### ILLUMINATION

**Button only or automatically with door.** The cooking space can be illuminated by pressing the LIGHT button at anytime, and will turn off automatically after 30 seconds.

### WATER HARDNESS

**Hard, medium or soft.** The oven default is for hard water. If you are unsure of your water hardness, you may use the test strip provided in your use & care guide. You may purchase additional test strips from a local home improvement center.

Follow the instructions on the test strip to determine your water hardness then select the appropriate hardness setting.

### TEMPERATURE UNIT

**Fahrenheit (°F) or Celsius (°C).**

### CONTRAST

Select from low to high contrasts for the control panel display. There are six settings, or boxes, which light up for increasing contrast.

### FORMAT

**12-hour (am/pm) or 24-hour clock.** In 24-hour mode the display is dimmed between 24:00 and 6:00.

### FACTORY SETTINGS

**Reset.** Returns all user settings to the factory preset.

### WATER DOOR CONTROL



**Button only or automatically with message.** If automatically with message is selected, the water door panel will open automatically if the water tank empties during operation. The flap may also be opened at any time by pressing the WATER button. Do not attempt to open the water door manually.

## Selecting Operating Modes

### SELECTING OPERATING MODE

- 1) Press the MODE button until the desired mode appears.
- 2) Press the control knob to confirm the mode.

#### Example:

- 1) Press the MODE button until you reach auto steam bake mode. 'Auto Steam Bake—Rack 2 or 1+3' appears in the text display. The recommended temperature flashes in the upper left digital display. The auto steam bake  and temperature  symbols flash.
- 2) Press the control knob to confirm. 'Auto Steam Bake—Steam phase' followed by 'Auto Steam Bake—Hot air phase' appears in the text display.

### CHANGING OPERATING MODE

- 1) Press the OFF button. The selected operating mode is ended.
- 2) Press the MODE button to select a new operating mode.

## Selecting Temperature

After a cooking mode is selected, the temperature can be set.

### SELECTING COOKING SPACE TEMPERATURE

- 1) Press the TEMP button.
- 2) Turn the control knob to set the desired cooking space temperature and press to select.
- 3) Once the mode has started, you can press the TEMP button and turn the control knob to change the temperature. Press the control knob to select the temperature.

## Turning Oven Off

- 1) Press the OFF button. The temperature and mode symbols go out. Steam is gradually released from the cooking space over 1 minute to avoid a rush of steam when the oven door is opened. The cooling fan can continue to run. 'Residual heat' appears in the text display.
- 2) After each use, leave the oven door open in the "at-rest" position, until the interior has cooled down. Refer to the illustration below. When cool, wipe the cooking space dry before closing the door.

After turning off any mode utilizing steam, the display will read 'Water is being pumped off'. Be sure not to remove the water tank during this time.

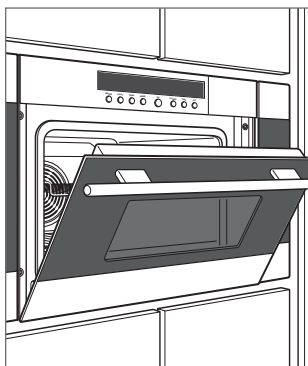

Oven door "at-rest" position.

## Timer and Timer Functions

The Wolf convection steam oven includes timer functions that manage cooking start and stop times so you can be away from the kitchen and still enjoy hot-from-the-oven meals at pre-specified times. Please take a moment to set your local time, and learn more about these useful time-saving features.

The timer can be used at any time, independently of other functions.

### SETTING CURRENT TIME

- 1) Press the TIME button.
- 2) Turn the control knob to set the hour and press to select.
- 3) Repeat for minutes.

### SETTING THE TIMER

- 1) Press the TIMER button.
- 2) Turn the control knob to set duration. The timer can be set for up to 9 hours, 59 minutes. For the first 10 minutes, the intervals are 10 seconds. Example: 5' 40. After 10 minutes, one minute intervals can be selected.
- 3) Press the control knob to start. 'Timer' appears in the text display window and the countdown of time is visible in the right digital display. The timer ⌚ symbol illuminates. When timed duration is up, a sequence of audible signals repeats for one minute. 'Timer finished' appears in the text display and the timer ⌚ symbol flashes.

## Timer and Timer Functions

### TURNING OFF TIMER NOTIFICATION

- 1) Press the TIMER button.

### CHECKING / RESETTING TIMER

- 1) Press the TIMER button to view countdown.
- 2) Turn the control knob to change duration and press to select.

### TURNING TIMER OFF

- 1) Press the TIMER button twice. The right digital display will flash 0'00.
- 2) Press the control knob to confirm.

### OPERATING TIME

The operating time feature automatically turns the oven off at the desired time. These instructions assume you have placed food in the cooking space and selected a mode and temperature.

### SETTING OPERATING TIME

Preheat the cooking space if necessary before setting time.

- 1) Press the TIME button.
- 2) Turn the control knob to set the duration. Operating mode automatically turns off when the operating time has been reached.

### CHECKING / CHANGING OPERATING TIME

- 1) Press the TIME button. Time remaining flashes in the right digital display. The operating time  symbol flashes.
- 2) Turn the control knob to change duration and press to select.

### TURNING OFF BEFORE TIME

- 1) Press the OFF button.

### END OF TIME SIGNALS

The selected mode turns off automatically when the operating time is up. Notification includes a long, intermittent audible signal emitted for 1 minute. 'Operating time finished—Continue: select duration' appears in the text display. Cooking space temperature appears in the left digital display and the operating time  symbol flashes in the right digital display. Settings remain for 3 minutes.

### EXTENDING TIME

- 1) Turn the control knob to select a new duration within 3 minutes of the time ended notification.

### TURNING OFF

- 1) Press the OFF button. Settings are cleared. Residual heat temperature continues to be displayed.

## Delayed Start

The delayed start feature automatically turns the convection steam oven both on and off at desired times. The instructions below assume you have placed food in the cooking space and selected a mode and temperature.

### SETTING DELAYED START TIME

- 1) Press the TIME button.
- 2) Turn the control knob to select the operating time.
- 3) Press the TIME button again
- 4) Turn the control knob to select the switch-off time and press to confirm.

**Example:** At 8:00 am, select convection mode and 355°F. Press the time button and select an operating time of 1 hour. Press the time button again and set the switch-off time to 9:30. Press the control button to confirm. The oven will remain off with the switch-off time  symbol illuminated. The oven will turn on at 8:30 automatically.

### CHECKING / CHANGING SWITCH-OFF TIME

- 1) Press the TIME button. The operating time is visible for 3 seconds.
- 2) Press the TIME button again. The switch-off time flashes.
- 3) Turn the control knob to adjust the switch-off time and press to confirm. When the switch-off time flashes, turn the control knob to change. The switch-off time can be delayed by a maximum 11 hours 59 minutes in 12-hour mode and 23 hours, 59 minutes in 24-hour mode.

### TURNING OFF BEFORE TIME

- 1) Press the OFF button.

### END OF TIME SIGNAL

The operating mode turns off automatically when the operating time is up.

- A long, intermittent audible signal is emitted for 1 minute. 'Operating time finished—Continue: select duration' appears in the text display.
- The cooking space temperature appears in the left digital display.
- The time flashes in the right digital display.
- The operating time  symbol flashes.
- The settings remain for 3 minutes.

### TURNING OFF

- 1) Press the OFF button. Settings are cleared. Residual heat temperature continues to be displayed.

### USING DELAYED START WITH TEMPERATURE PROBE

When using delayed start with the probe, the oven will automatically turn off when the set probe temperature is reached, which may be somewhat earlier or later than the set switch-off time.

### ADDITIONAL NOTES ON DELAYED START

Delayed start is available for recipes that do not require preheating, including Wolf gourmet, recipes or my recipes. Perishables should not be kept unrefrigerated.

### Using the Temperature Probe

The probe monitors your food's temperature and announces when it has reached a temperature considered "done" and safe for consumption. Using the probe also helps to maintain ideal tenderness.

The internal temperatures shown in the chart below are the USDA recommendations for safe food consumption. Your desired doneness may vary.

#### INTERNAL TEMPERATURE

DONENESS	INTERNAL TEMP
<b>BEEF, LAMB AND VEAL</b>	
Rare	140°F (60°C)
Medium Rare	145°F (65°C)
Medium	160°F (70°C)
Well Done	170°F (75°C)
<b>PORK</b>	
Well Done	170°F (75°C)
<b>POULTRY</b>	
Well Done Breast	170°F (75°C)
Well Done Thigh	180°F (80°C)
Well Done Stuffing	165°F (75°C)

#### POSITIONING THE TEMPERATURE PROBE

- 1) Insert the probe into the thickest part of the meat so that the tip is in the center of the meat. Bury the entire metal shaft into the dish, or as much as is possible. To maintain accuracy, avoid touching bone or fat with the probe as they conduct heat faster.
- 2) Insert the plug end of the probe into the socket located on the right interior oven wall behind the metal flap.
- 3) Ensure probe cable is neatly tucked inside of the oven interior. Close the oven door.

#### SETTING THE PROBE TEMPERATURE

- 1) Select the operating mode and cooking space temperature.
- 2) With the probe positioned and plugged in, press the TEMP button until the display reads 'Probe Temperature'.
- 3) Turn the control knob to set the probe temperature based on the desired level of doneness and press to select. Probe temperature appears in the left digital display when the temperature reaches 85°F or higher.

## Using the Temperature Probe

### CHECKING AND CHANGING PROBE TEMPERATURE

The TEMP button toggles between displaying the actual probe temperature and the set temperature.

- 1) To change the set probe temperature, press the TEMP button twice until the display reads 'Probe Temperature', then turn the control knob to set a new temperature and press to select.

### END OF COOKING

When the set probe temperature is reached, the oven automatically turns off.

- 'Probe temperature reached' appears in the text display, and the actual probe temperature appears in the left digital display.
- The probe  symbol will flash and an audible signal will sound for 1 minute.
- Probe temperature may continue to rise due to residual heat.

## Preparing for First Use

Please take a moment to record the serial number of your convection steam oven, the installation date and company that performed the installation on page 42 of this guide.



## Preparing for First Use

### CLEANING

Clean the cooking space and accessories with warm, soapy water and a soft cloth.

### OPEN THE WATER TANK

- 1) Press the WATER button.

**IMPORTANT NOTE:** Always use this button to open the water tank. Trying to access the water tank manually will damage the oven.

### FILL THE WATER TANK

- 1) Fill the tank with fresh, cold tap water. Never fill the tank with demineralized, filtered or distilled water.
- 2) Close the lid.
- 3) Push the water tank into its compartment and ensure it is seated firmly.

The water tank holds enough water for 1.5 hours of continuous steam, typically enough for four or five cooking sessions. In the event the tank needs refilling in the middle of a cooking session, add no more than 2 cups of water. This will prevent overflow when water is pumped back into the tank.

### CLOSE THE WATER TANK

- 1) Close the panel flap manually.

### BEFORE USING FOR THE FIRST TIME

Heat the empty cooking space without baking pans using auto steam bake mode for 30 minutes at 410°F.

### EMPTYING THE WATER TANK

When the oven is turned off, residual water is pumped back into the water tank.

- 'Water is being pumped off' appears in the text display. Residual water is not pumped back until its temperature is below 175°F. If 'Do not remove water tank' is displayed in the text display, the temperature of the residual water is still over 175°F.
- When the water has been pumped back you may remove, empty and dry the water tank.
- When the symbols are no longer illuminated and the text display is dark, the oven is off.
- Any operating mode can be started again at any time.

## Cooking Modes

Twelve cooking modes bring the world of modern food preparation right into your kitchen. Steam mode perfectly poaches fish. Auto steam bake turns out breads that are tender inside and delightfully glossy and crusty outside. Now you can enjoy meats, casseroles, breads, appetizers, desserts or multi-course meals with enhanced taste, texture and appearance.







### QUICK LEARNING GUIDE

In this section you will learn about each mode, its benefits to you, and receive suggestions to help you decide when you would want to select that mode.

We also recommend that you take advantage of the demonstration recipes with each mode for immediate hands-on experience—and an end product that showcases the professional results that you can look forward to.

Now is also a good time to get into the habit of leaving the oven door open after cooking in the “at-rest” position and when the interior is cool wiping the cooking space dry. This makes the cooking space clean for the next session.

### COOKING MODES

MODE	USES
<b>Steam Function</b> 	Use the steam function for foods you would have heated in a saucepan and for all foods that would benefit from gentle handling.
<b>Reheat Function</b> 	Use in place of reheating in oven, range or microwave.
<b>Auto Steam Bake</b> 	Use for breads, buns, cakes and pastries whether fresh, par-baked or frozen.
<b>Convection Mode</b> 	Use for baking muffins, biscuits and roasts.
<b>Convection Humid</b> 	Use for cakes, casseroles, grain dishes, lasagna and meats.
<b>Convection Steam</b> 	Use for foods you want tender inside and roasted or crisped outside.
<b>Wolf Gourmet</b>	Use to prepare specified foods, whether fresh, refrigerated or frozen.
<b>Slow Roast Mode</b>	Use to keep meats tender by slow roasting.
<b>Recipes Mode</b>	Use to cook entire meals from appetizers and entrees to desserts.
<b>My Recipes</b>	Use to store cooking instructions for recipes you prepare frequently.
<b>Keep Warm Mode</b>	Use when food cannot be eaten when it's hot from the oven.
<b>Cleanse Mode</b>	Use to cleanse baby bottles and canning jars with steam.

## Steam

From vegetables, poultry and fish to grains, beans, pasta and egg dishes, gentle steam heat is ideal for capturing nutrition, color and flavor.

Steam mode heats with steam and hot air, with a temperature range of 85°F to 210°F: just enough heat to firm up a batch of homemade yogurt, or greater steam heat to thoroughly cook meats and side dishes to perfection.

Use the steam function for any food you would have heated in a saucepan, and for all foods that would benefit from gentle handling such as fish and seafood, veggies and rices. Steam offers great flexibility. Cook meal elements together such as chicken and rice or fish and veggies without odor or flavor transfer. Prepare frozen vegetables and defrost foods evenly without any hot spots. Gently extract juices while preserving the integrity of flavor, color, texture, shape and vitamin content.

### TIPS

- Foods with similar cooking times may be cooked together, saving energy and clean-up time.
- Place the solid stainless steel pan underneath the perforated pan to collect condensate and food spills.
- Season vegetables after steaming.

### STEAM RECIPE

#### Steamed Shrimp

1 lb thawed, raw shrimp, peel on  
1 tablespoon old bay seasoning  
1 lemon, juiced  
1 lemon, cut into 6 wedges  
Handful of parsley sprigs

Combine all ingredients together in a large mixing bowl.

Place the solid stainless steel pan in the convection steam oven on rack position 1. Pour the contents of the mixing bowl onto the perforated stainless steel pan, taking care to spread the shrimp out evenly, and place in the steam oven on rack position 2. Set the oven to 200°F on the steam mode. Set the timer for 7 minutes.

## Reheat

Reheat mode uses steam and hot air to rehydrate food gently. Combining just the right balance of air convection and rehydrating moisture, reheat mode warms one to four pans of food evenly and without drying.

Reheat mode temperatures range from 210°F to 300°F. Entrees, casseroles, sides and leftovers are warmed to serving temperature without compromising quality. Frozen meals and convenience foods can also be brought gently and thoroughly up to their ideal serving temperatures. Bread baked days ago can be regenerated at 300°F for an aromatic, fresh-from-the-oven crust and moist interior.

Use the reheat function for any food you would have reheated in the oven, range or microwave with superior results.

### TIPS

- If bakery or roast looks good on the outside, but is still doughy or raw on the inside, try a lower cooking space temperature and lengthen operating time.
- If regenerated food seems dry, try a lower cooking space temperature and shorten operating time.
- If there is too much condensate on or around food, try a higher cooking space temperature and lengthen operating time.

## Auto Steam Bake

Bake just like a professional with auto steam bake mode. By heating with steam first, then using convection heat to finish baking, bagels, breads, buns, rolls and pastries acquire a tender interior, a beautiful exterior and a natural shine without the need for brushing with an egg wash.

Auto steam bake mode temperatures range from 210°F to 445°F. Use this mode for breads, buns, cakes and pastries whether fresh, par-baked or frozen. Do not preheat.

### TIPS

- After shaping, allow bread and other yeast products to proof briefly on the counter. Ten minutes is usually sufficient. Place the dough on the stainless steel pan, which has been lined with parchment, put it into the unheated cooking space and bake using the auto steam bake operating mode.
- A nice, shiny crust is formed during auto steam bake. Yeast and puff pastries do not need to be brushed with egg yolk, oil or cream.
- The oven door should not be opened during the steaming phase. The introduction of cold air will prolong the steaming phase, oversteaming the bread and impeding rising.
- For a nice, crispy crust on smaller items use a higher temperature during the hot air phase. The optimum baking temperature for buns is generally higher than for a single loaf of bread.

### AUTO STEAM BAKE RECIPE

#### Simple No-Knead Bread

3<sup>1</sup>/<sub>4</sub> cups bread flour  
1/4 teaspoon instant yeast  
1<sup>1</sup>/<sub>4</sub> teaspoon salt  
1<sup>3</sup>/<sub>4</sub> cup water

Place all ingredients into a large mixing bowl. With a wooden spoon or a spatula, stir the ingredients until they come together. The dough will be sticky. Cover the bowl with plastic wrap and leave out on the counter overnight (10–12 hours). The next day or later that same day, with generously floured hands, form the dough into a ball. With a sheet of parchment paper on the solid stainless steel pan, sprinkle a light dusting of flour or cornmeal and place the dough in the center of the pan. Dust the top of the dough with flour and cover with a large bowl, loose plastic wrap or a cotton towel. Allow to rise for 2 hours. Slash the risen dough with a sharp knife or razor blade across the top.

Place the pan in the convection steam oven on rack position 2. Select auto steam bake mode and adjust the temperature to 425°F. Press the control knob to start. After approximately 20 minutes, open the oven door and insert the probe into the loaf of bread from the side so that the probe's tip is approximately centered in the bread. Plug the probe into the probe receptacle and set the probe temperature to 210°F.

## Convection

A fan creates the movement of hot air created by a heating element at the back of the oven for convection cooking to distribute heat evenly around food for consistent results and browning. Convection also eliminates odor transfer making it ideal for cooking desserts, meats and vegetables all together.

Convection mode temperatures range from 85°F to 445°F. Cooking temperatures versus traditional ovens may be 25 degrees less, and times may be about 25% faster, saving valuable time and lowering energy costs.

Use convection mode for muffins, biscuits and roasts. Convection mode is also ideal for speeding up cooking time, and for cooking different types of foods together at once to save time. For instance, add dinner rolls and aromatic veggies like broccoli to your meat-cooking session without any odor transference to create a complete meal where every menu item is conveniently cooked together, and is done at the same time.

## CONVECTION RECIPE

### Chocolate Chip Cookies

1½ cups unsalted butter, softened  
2 cups firmly packed brown sugar  
½ cup white sugar  
2 eggs  
1 tablespoon vanilla  
1 teaspoon baking soda  
1½ teaspoons salt  
1 teaspoon baking powder  
3½ cups flour  
1 tablespoon brewed coffee  
2½ cups chocolate chips

In mixer bowl, cream butter with sugars until smooth. Add eggs, one at a time, scraping bowl after each egg. Add vanilla and coffee; continue to mix on medium high speed until mixture is light and fluffy. Sift together flour, baking soda, baking powder and salt. Add mixture to the bowl. Mix in chocolate chips on low speed for 10 seconds. Scrape sides of the bowl and continue mixing until just combined.

Line the solid stainless steel pan with parchment paper. Place dough by 3-tablespoon mounds on the lined pan, 12 mounds per sheet. Place the pan in the convection steam oven on rack position 2. Select convection mode and adjust the temperature to 325°F. Bake the cookies for approximately 13 minutes or until done.

## Convection Humid

In convection humid mode, a heating element at the back of the oven produces heat and oven ventilation is sealed so that moisture produced during cooking remains in the oven.

Convection humid temperatures range from 85°F to 445°F.

Use convection humid for cakes, casseroles, grain dishes, lasagna and meats.

### CONVECTION HUMID RECIPE

#### Scallop Potatoes

6 medium potatoes, peeled and sliced  
6 tablespoons of butter  
1½ cup milk  
2 tablespoons corn starch  
⅓ cup diced onion  
1 cup diced ham  
½ teaspoon kosher salt  
¼ teaspoon freshly ground black pepper

Mix potatoes, ham and onions and place in greased 9-inch casserole dish. Make sauce by combining milk, butter, salt, pepper and cornstarch. Cook over medium heat, stirring constantly until smooth and thickened.

Pour mixture over potatoes and place on a wire rack set on rack position 2 in the convection steam oven. Select convection humid mode and adjust the temperature to 345°F. Bake for approximately one hour and fifteen minutes or until golden brown and bubbly.





## Convection Steam

Convection steam is great for roasting vegetables, grains or potatoes, and multiple items together, like a 12-pound turkey with trimmings. Cook the turkey with steam, then add vegetables or potatoes, turn off steam, and it will all roast and be done together. You control the steam supply.

Convection steam mode temperatures range from 85°F to 445°F. Steam transfers energy to the food more efficiently than hot air alone, which speeds up the cooking process. Food retains its own moisture and delicate parts are more resistant to burning.

Use convection steam for any foods you want to be tender inside and roasted or crisped outside.

### CONTROLLING THE STEAM SUPPLY

- Press the MODE button to deactivate steam. The steam  symbol goes out.
- Press the MODE button to activate steam. The steam  symbol illuminates.

### CONVECTION STEAM RECIPE

#### Roast Chicken with Herbs and Lemon

1 fryer hen  
8 garlic cloves chopped  
6 garlic cloves left whole  
2 tablespoons fresh rosemary, chopped  
3 tablespoons fresh thyme, chopped  
1 lemon, zested  
1 bunch parsley  
1 small bunch of thyme  
Kosher or sea salt  
Freshly ground black pepper

Combine chopped garlic, rosemary, and thyme with the zest of one lemon in a small bowl. Using your hands rub the herb mixture all over the chicken covering evenly. Cut the zested lemon into slices. Stuff the chicken with the lemon slices, parsley, whole garlic cloves and bunch of thyme. Season the chicken with salt and freshly ground black pepper.

Place the chicken on the solid stainless steel pan and place in the convection steam oven on rack position 1. Select convection steam mode and adjust the temperature to 400°F. Insert the probe into the thickest part of the breast. Plug the probe into the probe receptacle and set the probe temperature to 165°F.

## Wolf Gourmet

Wolf gourmet cooks food to perfection; simply tell it what type of food you are putting inside of the oven. The climate sensor knows the amount, shape and consistency and adjusts time, temperature and humidity so no baking instructions are required.

Select your item and preferred level of doneness. After a few minutes it will tell you when your dish will be ready. Great results are achieved easily, quickly and stress-free.

Use Wolf gourmet to prepare any of the following foods, whether they come fresh from your garden, refrigerator, freezer or pantry:

Wolf Gourmet	Code
Fresh Appetizers	A1
Frozen Appetizers	A2
Baked Dish	A3
Soufflé	A4
Baked Potatoes	A5
Frozen Potato Products	A6
Braising Meat	A7
Fresh Pizza	A8
Frozen Pizza	A9
Custard	A10
Bread	A11
Yeast Pastry with Filling	A12
Cake	A13
Torte	A14

### SELECTING AND STARTING WOLF GOURMET

#### Example: A14 Torte

- 1) Press the control knob to activate the text display, select Wolf gourmet.
- 2) Turn to 'A14 Torte' and press to select.
- 3) Turn to preferred level of brownness and press to select.
- 4) Press to start. 'A14 Torte—Appliance is preheating' appears on the text display. A single audible signal indicates when the cooking space temperature is reached. 'Put food into cooking space—Press OK to continue' appears on the text display.
- 5) Place torte in oven.
- 6) Press control knob (OK) to continue cooking.

### TURNING OFF BEFORE TIME

- 1) Press the OFF button twice.



### TIPS

- For Wolf gourmet to determine optimum cooking or baking time, the initial cooking space must be cool and the oven door should remain closed until the 'h' no longer flashes in the digital display.
- For frozen products, instead of degree of browning, select approximate cooking or baking time.

## Slow Roast

Slow roast mode is the ultimate convenience. Insert the probe into your prepared meat, select a slow roast setting, tell the oven what time you want it done, and come home to a perfectly cooked meal.

### SELECTING AND STARTING SLOW ROAST

- 1) Press the control knob to activate the text display, turn to slow roast and press to select.
- 2) Turn the knob until the cut of meat you are preparing appears in the display, press to select. For some slow roast selections, a choice of doneness is offered. Select your preferred level of doneness and press to confirm. The preset probe temperature appears in the left digital display. To adjust this temperature, press the TEMP button, turn the control knob to the desired temperature and press to select.
- 3) The default operating time for all slow roast selections is 3.5 hours. Any duration between 2.5 and 4.5 hours can be selected in one minute intervals. To change the operating time, press the TIME button. Turn the control knob to the desired time and press to select.
- 4) Slow roast can be started immediately or a if desired, a specific completion time can be chosen.
- 5) To select a specific completion time, press the TIME button twice. 'Switch-off time' appears in the text display. The earliest completion time appears in the right hand digital display. Turn the control knob to select the desired completion time and press to select.
- 6) Press the control knob to start slow roast. Convection , temperature probe  and operating time  symbols illuminate.

### TURNING OFF BEFORE TIME

- 1) Press the OFF button twice. If the OFF button is pressed in advertently during operation, simply press the control knob to continue operation.

### TIPS

- Optimal weight of meat: 1 to 4.5 pounds.
- Optimal meat thickness: at least 1.5 inches.
- Briefly sear the meat on all sides.
- Place the meat in a glass or porcelain roasting dish.
- Properly position the probe per instructions on page 14.
- Settings cannot be adjusted after the start.
- Cooking durations of 2.5 to 4.5 hours are possible.

## Recipes Mode

### SELECTING AND STARTING A RECIPE

Use the recipes mode for an easy and fun way to cook entire meals from appetizers and entrees to desserts. The recipes are listed by code in the chart below and on the following pages.

The recipe collection harnesses the power of many different cooking modes. All you need to do is place your food into the cooking space, turn the control knob to recipes, make your selection, and choose the number of portions or level of browning. The oven determines the rest of the details for you and never overcooks, for delightful results.

The recipes mode is ideal if you are in a hurry, looking to try a new recipe, or need to prepare a variety of food for a party or social occasion.

Recipes	Code
Appetizers	R1
Fish in Puff Pastry	R2
Fish Rolls	R3
Beef Stroganoff	R4
Beef Pot Roast	R5
Pork Loin in Puff Pastry	R6
Pasta Gratin	R7
Eggplant Gratin	R8
Flan	R9
Pears in Red Wine	R10
Rolls	R11
Muffins	R12
Cake	R13
Focaccia	R14

### RECIPES

#### R1 Appetizers *(approx. cook time—20 minutes)*

- 2 rolls puff pastry
- 2 tablespoons olive oil
- 4 tablespoons fresh oregano, chopped
- 4 tablespoons fresh thyme, chopped
- 1 ounce Parmesan cheese, shredded

Lay out a sheet of puff pastry and brush lightly with olive oil. Sprinkle the herbs and Parmesan cheese onto the pastry evenly. Lay the second sheet of puff pastry on top and press down lightly. Use a pastry cutter to cut the puff pastry into strips. Twist the strips from the ends.

Cover the stainless steel pan with parchment paper and lay the twisted puff pastry strips out evenly.

Put the solid stainless steel pan into the cold cooking space on rack 1 (racks 1 and 3 if two pans are being used). Start the recipe.

## Recipes Mode

### RECIPES

#### **R2 Fish in Puff Pastry** (approx. cook time—25 minutes)

1 roll puff pastry  
1 red pepper  
1 green zucchini  
Flat leaf parsley  
Salt  
Pepper  
4 small portions firm fish, 2 ounces each

Cut the pepper in half, remove the stalk, seeds and white membranes, then cut into strips lengthways. Cut the stalk off the top of the green zucchini and cut it into slices, lengthways.

Cut the puff pastry into four equal-sized rectangles. Lay the pepper and green zucchini diagonally across the pastry pieces, sprinkle each with parsley and season with salt and pepper. Place the fish on top. Pull the two free corners of the pastry over the fish.

Cover the stainless steel pan with parchment paper and place the wrapped pieces of fish on it.

Put the stainless steel pan into the cold cooking space on rack 1. Start the recipe.

#### **R3 Fish Rolls** (approx. cook time—10 minutes)

8 sole fillets (any flat whitefish can be substituted, such as Flounder or Turbot)  
Salt  
Pepper  
3<sup>1</sup>/<sub>2</sub> ounces rocket arugula  
1 ounce pine nuts, toasted

Season the sole fillets with salt and pepper. Spread the rocket arugula and toasted pine nuts on the fish fillets. Roll the fillets up from the pointed end, then secure them with toothpicks. Grease the perforated stainless steel pan with pan spray and place the fish rolls on it.

Put the perforated stainless steel pan into the cold cooking space on rack 2. Start the recipe.

#### **R4 Beef Stroganoff** (approx. cook time—47 minutes)

1<sup>3</sup>/<sub>4</sub> pounds beef chuck roast, cut into thin 2" long strips  
Salt  
Pepper  
1 tablespoon beef bouillon  
1 yellow pepper, sliced  
1 red pepper, sliced  
8 ounces sliced mushrooms  
2 small yellow onions, sliced thin  
1 packet gravy powder  
2 tablespoon tomato paste  
2 teaspoons cornstarch  
6 fluid ounces heavy cream  
1 teaspoon paprika

Season the meat with salt and pepper

Place the meat in a large casserole dish and scatter the beef bouillon, peppers, mushrooms and onions over the top.

Place the casserole dish into the cold cooking space on rack 2. Start the recipe. The oven will run for approximately 40 minutes. After the timer goes off, carefully remove the dish, strain out any liquid into a small saucepan and reserve. Place the casserole dish back into the oven and press OK to continue.

Whisk the remaining ingredients with the liquid in the small saucepan and bring to a boil to thicken. When the oven timer goes off, carefully remove the casserole dish and add the sauce. Serve alone or over egg noodles.

## Recipes Mode

### RECIPES

#### **R5 Beef Pot Roast** (approx. cook time—2 hours)

2½ pounds beef chuck roast, cut into 3 pieces  
 2 carrots, peeled and quartered  
 ½ small celeriac, peeled and quartered  
 2 small yellow onions, quartered  
 1 bay leaf  
 2 cloves  
 8 black pepper corns  
 3–4 cups vegetable stock

Place the meat, vegetables and spices in a small casserole dish. Add enough vegetable stock to cover.

Place the casserole dish into the cold cooking space on rack 2. Start the recipe.

#### **R6 Pork Loin in Puff Pastry** (approx. cook time—30 min)

1 roll puff pastry  
 1 pork loin, approximately 1 pound  
 Salt  
 Pepper

*TIP: Try adding chopped sundried tomatoes, or a whole grain mustard spread on the pork loin before wrapping with puff pastry.*

Cut the pork loin in half lengthwise and season with salt and pepper. Sear the pork loins in a large frying pan with oil until golden brown. Let the pork loin cool.

Lay out the sheet of puff pastry and cut it in half. Place one half of the pork loin on each sheet of puff pastry. Fold and roll the puff pastry around the pork loin ending up with the seam-side down. Place the pork loins on the stainless steel pan lined with parchment paper. Place the pan into the cold cooking space on rack 2. Start the recipe.

#### **R7 Pasta Gratin** (approx. cook time—30 minutes)

10–12 ounces uncooked pasta (shells or elbow macaroni)  
 2 small yellow onions, sliced  
 8 ounces sliced mushrooms  
 3 ounces air dried ham, such as prosciutto  
 1 bunch of flat leaf parsley, chopped  
 2 cups vegetable stock  
 1 cup heavy whipping cream  
 Salt  
 Pepper  
 Nutmeg  
 5 ounces Italian cheese, grated

Place the pasta, onions, mushrooms, ham and parsley into a greased casserole dish and mix together.

For the sauce, stir the vegetable stock and whipping cream together and season with salt, pepper and nutmeg. Pour the sauce over the pasta. Sprinkle with grated cheese.

Place the casserole dish into the cold cooking space on rack 2. Start the recipe.

#### **R8 Eggplant Gratin** (approx. cook time—30 minutes)

2 medium eggplants  
 14 ounces canned plum tomatoes (or jar of pasta sauce)  
 1 clove garlic crushed  
 Fresh oregano, chopped  
 Fresh thyme, chopped  
 1 tablespoon olive oil  
 Salt  
 Pepper  
 4 ounces Italian cheese, grated

Crush the plum tomatoes in a bowl with a fork. Mix the tomatoes with the garlic, herbs and olive oil. Season with salt and pepper.

Remove the tops of the eggplants and cut them into ½" thick slices. Spread a little tomato sauce over the base of a greased casserole dish. Lay the eggplant slices in the dish and cover with crushed tomatoes. Sprinkle with cheese.

Put the casserole dish into the cold cooking space on rack 2. Start the recipe.

## Recipes Mode

### RECIPES

#### **R9 Flan** (approx. cook time—25 minutes)

- 1/4 cup sugar
- 1/2 cup orange juice
- 2<sup>1</sup>/<sub>8</sub> cup half and half or heavy cream
- 1/4 cup sugar
- 1 vanilla bean, split lengthwise
- 3 eggs, beaten

For the sauce, caramelize the sugar in a pan so that it turns light brown in color. Pour the orange juice into the pan and allow to reduce by half.

Cover the bases of the flan dishes with the orange caramel sauce.

Place the half and half (or heavy cream), sugar and vanilla bean in a sauce pan and heat to 105°F. Take out the vanilla bean pod. Slowly temper the beaten eggs with the warm cream. Pour through a fine strainer into the dishes.

Put the dishes on to the perforated stainless steel pan, and place into the cold cooking space on rack 2. Start the recipe.

After fully cooled, run a knife carefully around the edge of each dish and turn the flans out on to a plate, pour the remaining sauce from the dish over the top of the flan.

#### **R10 Pears in Red Wine** (approx. cook time—15 minutes)

- 6 pears
- 1 cup red wine
- 1/4 cup sugar
- 1 vanilla pod, split

Cut two sides off of each pear.

Mix the red wine and sugar together in the casserole dish, then add the scraped out vanilla bean and pod. Place the pears in the casserole dish face down.

Put the casserole dish into the cold cooking space on rack 2. Start the recipe.

#### **R11 Rolls** (approx. cook time—33 minutes)

- 3<sup>1</sup>/<sub>4</sub> cups flour
- 3 tablespoons sugar
- 1 packet instant yeast
- 1 cup warm milk
- 4 tablespoons butter, melted
- 1 teaspoon salt
- 1/4 cup milk
- 1 tablespoon sugar
- 2 tablespoons butter, melted

In an electric stand mixer combine the flour, sugar and yeast. Add the warm milk, melted butter and salt. Knead with a dough hook to until the dough comes together and away from the sides of the bowl. Knead for 5 minutes. Turn the machine off and let the dough rest for 15 minutes. After the rest period, knead the dough for an additional 3 minutes. Place the dough in a large container and cover with a damp cloth and leave at room temperature until it has doubled in volume (1–1<sup>1</sup>/<sub>2</sub> hours). Alternatively you can place the container in the refrigerator overnight. If the dough was placed in the refrigerator overnight allow the dough to “wake-up” for 1–1<sup>1</sup>/<sub>2</sub> hours before proceeding.

Divide the dough into 12 equal portions. Shape them into balls and put them in a greased casserole dish. Leave to rise another 40 minutes or until doubled in size.

For the glaze, heat the milk sugar and butter together. Set aside.

Place the casserole dish into the cold cooking space on rack 2. Start the recipe.

After about 15 minutes, an audible signal will sound and the cooking process is interrupted. Brush the glaze over the rolls. Press OK to continue.



## Recipes Mode

### RECIPES

#### **R12 Muffins** (approx. cook time—35 minutes)

##### For muffins:

2 cups flour  
 2/3 cup sugar  
 2 teaspoons baking powder  
 1/2 teaspoon baking soda  
 1/2 teaspoon salt  
 1/4 teaspoon cinnamon  
 2 eggs  
 4 ounces butter, melted  
 1 cup buttermilk  
 1 tablespoon lemon zest  
 1/2 teaspoon vanilla extract  
 1 1/2 cups blueberries  
 1/4 cup plain yogurt

##### For streusel:

1/2 cup flour  
 2 ounces butter, softened  
 1/4 cup sugar  
 1/4 cup walnuts, chopped  
 1 tablespoon lemon zest

Combine dry ingredients on low speed in an electric mixer. In a separate mixing bowl, whisk together the wet ingredients. Add to the dry along with the blueberries and very carefully mix them until just combined. Scoop the mixture into 12 jumbo, double lined muffin cups, filling about 2/3 of the way. You can also place the muffin batter in a container with a tight fitting lid and refrigerate overnight. For the streusel, mix all ingredients together in a bowl and combine with hands until crumbly. Sprinkle streusel over the top of each muffin.

Place the muffins on the stainless steel pan and place into cold cooking space on rack 1. Start the recipe.

#### **R13 Cake** (approx. cook time—1 hour)

1 cup softened butter  
 1 cup sugar  
 1/4 teaspoon salt  
 4 eggs  
 1 teaspoon vanilla extract  
 1 2/3 cup flour

Grease a 9" x 5" loaf pan and set it aside.

Beat the butter, sugar and salt until light and fluffy. While mixing, add the eggs one at a time. Add the vanilla. Mix the flour slowly into the other ingredients. Pour the mixture into the prepared loaf pan.

Start the recipe. The appliance preheats. When preheat is finished. Place the loaf pan on rack. Press OK to continue.

#### **R14 Focaccia** (approx. cook time—40 minutes)

1 1/3 cup warm water  
 1 teaspoon sugar  
 1 teaspoon salt  
 1 tablespoon olive oil  
 1 packet of instant yeast  
 4 1/4 cup bread flour  
 2 teaspoons dry Italian herb mix  
 Extra olive oil to drizzle on top after proofing

Mix the first seven ingredients together in the bowl of an electric mixer. Knead to a smooth dough. Leave the dough in the bowl and cover with a damp cloth. Allow to rise at room temperature until it has doubled in volume (about 2 hours).

Remove dough from the bowl and on a floured work surface, roll dough into a flattened ball. Place the dough into a sprayed 8-inch glass pie dish. Gently spread the dough out to fill the dish. Drizzle with olive oil and poke holes with your fingertips into the dough. Allow to rise until doubled (about 1 hour). Sprinkle with coarse sea salt.

Put the dish into the cold cooking space on rack 1. Start the recipe.

## My Recipes

It's easy to cook all your favorite recipes with a convection steam oven for healthier fare that tastes better than ever, makes meal preparation stress-free, and the cleanup a snap.

With my recipes you can add ten of your favorite recipes, and replace or edit them at your pleasure. Recipes may also be copied into my recipes, and even edited as you see fit. Keep a record of your recipes on the following pages.

Use my recipes to store cooking instructions for recipes you enjoy cooking or baking frequently.

### MAKING RECIPE SETTINGS

- 1) Press the control knob to activate the text display, turn to my recipes and press to select.
- 2) Turn to the first empty recipe, 'My recipes—Recipe 1 (empty)' appears in the text display. Press the control knob to select and 'change' appears in the text display. Press to select and 'Step 1' appears in the text display.
- 3) If using the probe, plug in the probe before entering the settings.
- 4) Set the desired operating mode, cooking space temperature, probe temperature and operating time for step 1.
- 5) Turn the control knob to repeat the above sequence and enter additional steps.
- 6) Press the control knob, 'Recipe 1 (empty)—save' appears in the text display. Press to save.

### COPYING A RECIPE

Any recipe that is stored can be copied and changed.

- 1) Press and turn the control knob to select the recipe to be copied and press to select.
- 2) Turn until 'copy' appears in the text display and press to select.
- 3) The desired (empty) storage space appears. Press to select. A storage space that is already being used can be overwritten.

### CLEARING A RECIPE

Recipes in my recipes may be removed.

- 1) Press and turn the control knob to select the recipe.
- 2) Turn the control knob until 'clear' appears in the text display and press to select. The recipe is deleted and the placeholder name, such as 'Recipe 1 (empty)', appears in the text display.

### My Recipes

NOTES: MY RECIPES

Recipe: \_\_\_\_\_

Code: \_\_\_\_\_

Mode: \_\_\_\_\_

Temperature: \_\_\_\_\_

Probe: \_\_\_\_\_

Notes: \_\_\_\_\_

\_\_\_\_\_

\_\_\_\_\_

\_\_\_\_\_

Recipe: \_\_\_\_\_

Code: \_\_\_\_\_

Mode: \_\_\_\_\_

Temperature: \_\_\_\_\_

Probe: \_\_\_\_\_

Notes: \_\_\_\_\_

\_\_\_\_\_

\_\_\_\_\_

\_\_\_\_\_

Recipe: \_\_\_\_\_

Code: \_\_\_\_\_

Mode: \_\_\_\_\_

Temperature: \_\_\_\_\_

Probe: \_\_\_\_\_

Notes: \_\_\_\_\_

\_\_\_\_\_

\_\_\_\_\_

\_\_\_\_\_

Recipe: \_\_\_\_\_

Code: \_\_\_\_\_

Mode: \_\_\_\_\_

Temperature: \_\_\_\_\_

Probe: \_\_\_\_\_

Notes: \_\_\_\_\_

\_\_\_\_\_

\_\_\_\_\_

\_\_\_\_\_

Recipe: \_\_\_\_\_

Code: \_\_\_\_\_

Mode: \_\_\_\_\_

Temperature: \_\_\_\_\_

Probe: \_\_\_\_\_

Notes: \_\_\_\_\_

\_\_\_\_\_

\_\_\_\_\_

\_\_\_\_\_

Recipe: \_\_\_\_\_

Code: \_\_\_\_\_

Mode: \_\_\_\_\_

Temperature: \_\_\_\_\_

Probe: \_\_\_\_\_

Notes: \_\_\_\_\_

\_\_\_\_\_

\_\_\_\_\_

\_\_\_\_\_

### My Recipes

NOTES: MY RECIPES

Recipe: \_\_\_\_\_

Code: \_\_\_\_\_

Mode: \_\_\_\_\_

Temperature: \_\_\_\_\_

Probe: \_\_\_\_\_

Notes: \_\_\_\_\_

\_\_\_\_\_

\_\_\_\_\_

\_\_\_\_\_

Recipe: \_\_\_\_\_

Code: \_\_\_\_\_

Mode: \_\_\_\_\_

Temperature: \_\_\_\_\_

Probe: \_\_\_\_\_

Notes: \_\_\_\_\_

\_\_\_\_\_

\_\_\_\_\_

\_\_\_\_\_

Recipe: \_\_\_\_\_

Code: \_\_\_\_\_

Mode: \_\_\_\_\_

Temperature: \_\_\_\_\_

Probe: \_\_\_\_\_

Notes: \_\_\_\_\_

\_\_\_\_\_

\_\_\_\_\_

\_\_\_\_\_

Recipe: \_\_\_\_\_

Code: \_\_\_\_\_

Mode: \_\_\_\_\_

Temperature: \_\_\_\_\_

Probe: \_\_\_\_\_

Notes: \_\_\_\_\_

\_\_\_\_\_

\_\_\_\_\_

\_\_\_\_\_

Recipe: \_\_\_\_\_

Code: \_\_\_\_\_

Mode: \_\_\_\_\_

Temperature: \_\_\_\_\_

Probe: \_\_\_\_\_

Notes: \_\_\_\_\_

\_\_\_\_\_

\_\_\_\_\_

\_\_\_\_\_

Recipe: \_\_\_\_\_

Code: \_\_\_\_\_

Mode: \_\_\_\_\_

Temperature: \_\_\_\_\_

Probe: \_\_\_\_\_

Notes: \_\_\_\_\_

\_\_\_\_\_

\_\_\_\_\_

\_\_\_\_\_

## Keep Warm

Sometimes great food cannot be enjoyed when it's hot from the oven. Instead of cooling it, putting it in the refrigerator, and then warming it again in the microwave, simply use the keep warm mode. Food can even be plated and multiple dinner plates can be kept warm at once, making staggered mealtimes more convenient for you and your family.

The combination of convection and steam heat preserves food's taste, texture, looks and quality so every bite is as delicious as if it were fresh from the oven.

### KEEPING COOKED FOOD WARM

- 1) Press the control knob to activate the text display, turn to keep warm and press to select. 'Keep warm—start' appears in the text display.
- 2) Press the control knob to start.

### TIPS

- If the cooking space is already hot, open the oven door and allow it to cool down for 3 to 4 minutes before starting the keep warm function. This ensures food does not overcook.
- For highest quality, select a keep warm operating time of less than 1.5 hours.

## Cleanse

Cleanse mode is ideal for baby bottles and canning jars. Using steam in a contained environment, the cleanse process is less fussy, faster, and safer than conventional methods.

### CLEANSE

- 1) Press the control knob to activate the text display, turn to cleanse and press to select.
- 2) Turn to the appropriate task, such as cleanse baby bottles or prepare jam jars, and press to select.
- 3) Press the control knob to start.

## Care and Maintenance

Your Wolf convection steam oven, with its external boiler that reduces mineral buildup, requires minimal maintenance. Observing the following tips will ensure a long life of continued service and beauty.

### AVOIDING DAMAGE

- Never use abrasive, caustic cleaning agents.
- Never use abrasive scouring pads, steel wool, etc. which can damage the surface.
- Do not place any protective insert or aluminum foil on the bottom of the cooking space.
- Keep the panel flap in front of the water tank unobstructed.
- Always use the control panel button to open the water tank door. Do not try to open the door manually.
- Do not use knives or cutting wheels on baking pans or other accessories.
- Do not use objects that can rust in the cooking space.
- Do not place items directly onto the bottom of the cooking space.
- Do not use silver cutlery in the cooking space.
- To prevent corrosion, allow the cooking space to dry and leave the oven door open in the at-rest position until the cooking space has cooled down.

### EMPTYING THE WATER TANK

- Allow sufficient time for the oven to cool down completely before any cleaning or wiping.
- Leave the oven door open in the at-rest position to help cool down the cooking space before cleaning and prevent corrosion.
- The water in the water tank can be hot. If 'Do not remove water tank' appears in the text display, the temperature of the residual water is still over 175°F.
- For safety reasons, the residual water is not pumped back until its temperature drops below 175°F. Any operating mode can be started at any time.
- When the oven is turned off, residual water is pumped back into the water tank. 'Water is being pumped off' appears in the text display.
- Don't let water sit. Once the water has been pumped back, the water tank may be removed, emptied and dried. When the water is pumped back, or after the steam phase, the water tank can be very hot.
- Only refill the water tank with fresh, cold tap water. Never fill it with demineralized, filtered, or distilled water.
- When the symbols are no longer illuminated and the text display is dark the oven is off.

## Cleaning

Thanks to an external boiler only steam (no water) enters the cooking space, minimizing lime scale deposits and making clean up easy.

### CLEANING THE COOKING SPACE

- After each cooking session leave the oven door open in the at-rest position until the interior has cooled down. When it has cooled, remove condensate or spilled food using a soft cloth dampened with soapy water. Dry with a soft cloth.
- Stubborn particles may be loosened by turning on steam mode for 30 minutes at 210°C before cleaning.
- Do not spray the inside or outside of the oven with water.
- Do not use a steam cleaner.
- Over time the cooking space acquires a golden hue. This is a normal property of stainless steel and does not affect operation, or the quality of cooking or baking.
- Blue tarnish spots and condensate residue can be easily removed with lemon juice or a mild acidic cleaning agent.

### CLEANING THE EXTERIOR

- Clean with a soft cloth dampened with water and a little dish soap. For metallic surfaces, rub in the direction of the original polish lines. Dry with a soft cloth.
- Do not spray the inside or outside of the oven with water.
- Do not use a steam cleaner.

### CLEANING THE ACCESSORIES

- The solid and perforated stainless steel pans, wire oven racks and rack guides can be cleaned in the dishwasher.
- Watermarks in the water tank can be removed using a standard descaler.
- If the water tank valve drips, descale it.
- Do not clean the probe or water tank in the dishwasher.



## Cleaning

### REMOVING THE OVEN DOOR

On occasion you may choose to completely remove the oven door for a thorough cleaning. Please exercise caution, as the door weighs approximately 18 lbs (8 kg).

#### To remove the oven door:

- 1) Open the oven door completely.
- 2) Flip the latches on both door hinges forward to the open position. Refer to the illustration below.
- 3) Close the oven door to the at-rest position and lift forward and out.

#### To reinstall the oven door:

- 1) From the front, guide both oven door hinges into the openings.
- 2) Open the oven door as far as it will go and flip the latches back to the closed position.

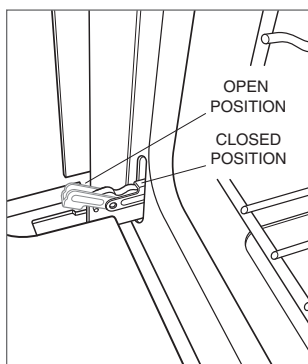

Oven door hinge latch.

### REPLACING THE DOOR SEAL

For safety reasons, the door seal must be replaced by Wolf factory certified service.

### REPLACING A DEFECTIVE LIGHT BULB

In the case of a defective light bulb please contact Wolf factory certified service.

### REMOVING RACK GUIDES

#### To remove rack guides:

- 1) Unscrew the knurled nuts in the front of the rack guides in a counterclockwise direction.
- 2) Pull the rack guides to the side of the threaded studs and remove from the front.

#### To reinstall rack guides:

- 1) Insert the rack guides into openings in the back wall of the cooking space and position onto the threaded studs.
- 2) Place the knurled nuts on the threaded studs and tighten securely in a clockwise direction.

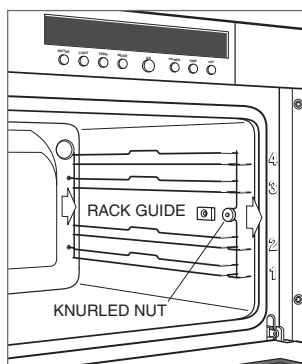

Remove rack guides.

### Running the Descal Program

Limescale deposits are a natural result of steam creation and will slowly build up inside of the external boiler and water lines.

The oven removes any guesswork and tells you when it is time to run the descale program. 'Boiler scaled up—please descale!' appears in the text display. We recommend that you run the descale program whenever the message appears. Failure to descale appropriately will cause damage and impair function.

Descaling takes about 45 minutes.

How often the oven notifies you to run the descale program is based on the water hardness that you specified when you personalized your settings. If you do not specify a hardness, the default setting is Hard.

Using steam four times a week for 30 minutes, the oven recommends descaling every 6–18 months. Refer to the chart below.

Descaling	
WATER HARDNESS	FREQUENCY
Soft	18 months
Medium	9 months
Hard	6 months

If you are unsure about the hardness of your cold tap water, test strips may be purchased at a local home improvement center.

Operating time remaining for steaming until the next descaling is determined by pressing the control knob, and turning to 'User settings—Descaling'.

### DURGOL® DESCALER

Durgol® contains highly effective decalcification acids for a gentle yet professional level of descaling.

Only use Durgol® brand descaling solution, following manufacturer instructions. Other descaling solutions may not be effective or contain foam-creating additives that will damage the oven.

Remove splashes immediately with water.

## Running the Descale Program

### RUNNING THE DESCALE PROGRAM

For safety reasons, the descale program cannot be interrupted or stopped once it is started.

- 1) Press the OFF button.
- 2) Press the control knob to activate the text display, turn to descale, press to select. 'Descale—Descale appliance' appears in the text display.
- 3) Press to select. 'Descale appliance—start' appears.
- 4) Press again to confirm. 'Add 1 pt (0.5 L) descaler—and press OK' appears.
- 5) Pour the entire contents of the descaler solution bottle into the water tank. Position the water tank into the water tank compartment.
- 6) Press the control knob to confirm. 'Descale appliance—running' appears in the text display. After about 30 minutes, 'Pour away descaler—Add 2 pt (1 L) water' appears in the text display.
- 7) Remove the water tank and fill with cold tap water to cool and dilute the solution before pouring it down the drain.
- 8) Fill the tank with cold tap water and reinsert it into the compartment. The rinsing phase starts automatically. 'Descale appliance—1st rinsing cycle' appears in the text display. After about 45 minutes 'Pour away water—Descaling completed' appears in the text display. Depending on the level of soil in the rinse water, the oven will determine whether additional rinse cycles are necessary. If prompted, follow the directions on the screen for additional rinse cycles.
- 9) Once the rinse cycles are complete, remove, empty and dry the water tank. If necessary, wipe the bottom of the cooking space with a soft cloth.

#### **▲ CAUTION**

Failure to dilute the solution before discarding may discolor sink and drain.

## Troubleshooting

If your Wolf convection steam oven is not operating properly, use the following troubleshooting guide before calling Wolf factory certified service. This guide will save you time and trouble and may help you avoid the expense of a service call.

### Oven does not operate; displays are not illuminated.

- Check the household fuse or circuit breaker to see if it has been blown or tripped. A power outage may also have caused a disruption in service.
- No electricity is being supplied to the oven. Have an electrician verify that the oven is connected to a proper electrical circuit.

### Illumination is not working.

- The light bulb is defective, call Wolf factory certified service.

### Oven starts making noise during operation.

- The oven may emit switching and pumping sounds during operation. Such sounds are normal. No action is needed.

### 'Fill water tank' appears in the text display.

- Fill the water tank and return it to the water tank compartment.

### 'Do not remove water tank' appears in the text display.

- For safety reasons, the water in the boiler is not pumped off until the temperature of the water drops below 175°F. If there is enough cold water in the water tank, the boiler will be automatically filled. This will cool down the water in the boiler. If there is not enough cold water in the water tank, it will take longer to cool down (this can take up to 30 minutes).

'Boiler scaled up, please descale!' appears in the text display.

- The boiler in the oven has mineral buildup: Run the Descale program.

'Appliance blocked, descaling necessary' appears in the text display.

- If the message does not disappear after repeating the descaling process several times, note down the error message in full and call Wolf factory certified service.

### Resetting error message.

Various situations including an interruption in the power supply can lead to an error message.

- 1) Cancel the error message by pressing the OFF button.
- 2) Disconnect the power supply for about 1 minute.
- 3) Reconnect the power supply.
- 4) If the error message still appears contact Wolf factory certified service.

### Setting the time after a power failure.

12:00 flashes in the right digital display and the time ⌚ symbol flashes. 'Power failure—Set time' appears in the text display.

- 1) Turn the control knob to set the hour and press to select.
- 2) Repeat for minutes.

## Troubleshooting

### Technical data.

- External dimensions: Refer to the installation guide.
- Electrical connection: Refer to identification plate 1.
- Note for testing institutes: The energy efficiency class according to EN 50304/EN 60350 is determined using convection humid. Placing thermocouples between the appliance door and the seal can cause leaks and hence erroneous measurements. The usable volume within the meaning of EN 50304/EN 60350 is obtained with the rack guides disassembled.
- General note: Maximum load capacity: 3 kg.
- Measurement of the temperature in the cooking space: The temperature of the cooking space is measured when the cooking space is empty according to an internationally accepted standard. Own measurements may be inaccurate and are not suitable for checking the accuracy of the temperature.

## Tips on Saving Energy

The Wolf convection steam oven is built to consume minimal energy. Observing the following tips can help you to achieve even more energy savings.

### OPERATION

- Choose convection humid mode over convection mode when possible. Convection humid uses comparatively less energy.
- The oven is equipped with automatic energy-saving stand-by. To reduce power consumption to an absolute minimum, select 'Time display—invisible' in the user settings. All safety functions remain active.
- Avoid opening the oven door frequently.
- Only turn on illumination if needed.
- Use residual heat. For cooking times over 30 minutes, turn the oven off 5 to 10 minutes before the end of cooking time. (Exceptions include soufflé, sponge, choux pastry and puff pastry.)
- Preheat the cooking space only when necessary.

### PACKAGING

Packaging materials including cardboard, plastic film and polystyrene that may be collected for recycling.

## Service Information

When requesting information, literature, replacement parts or service, always refer to the model and serial numbers of your Wolf convection steam oven. This information is found on the product rating plate located on the left oven side trim. The oven door must be open to view the rating plate. For location of the rating plate, refer to the illustration on page 7. Record the rating plate information below for future reference.

Model Number: \_\_\_\_\_

Serial Number: \_\_\_\_\_

Installation Date: \_\_\_\_\_

Wolf Factory Certified Service:

\_\_\_\_\_

Phone: \_\_\_\_\_

Authorized Wolf Dealer:

\_\_\_\_\_

Phone: \_\_\_\_\_

### BEFORE CALLING FOR SERVICE

Before calling Wolf factory certified service, refer to the troubleshooting guide on pages 40–41.

### PRODUCT REGISTRATION

Register your new Wolf product today so that we may ensure your satisfaction. You may register by one of the following options:

- 1) Mail in the completed Wolf product registration card.
- 2) Register online at [wolfappliance.com](http://wolfappliance.com).
- 3) Register by phone by calling Wolf customer care at **800-222-7820**.

The model and serial numbers of your unit are printed on the enclosed Wolf product registration card. If you provide us with your e-mail address, we will send you exciting new product updates and recipes as they become available, along with information on special events.

The information and images in this guide are the copyright property of Wolf Appliance, Inc. Neither this guide nor any information or images contained herein may be copied or used in whole or in part without the express written permission of Wolf Appliance, Inc. ©Wolf Appliance, Inc. all rights reserved.

Wolf, Wolf & Design, Wolf Gourmet, W & Design and the color red as applied to knobs are registered trademarks and service marks of Wolf Appliance, Inc. Sub-Zero, Sub-Zero & Design, Dual Refrigeration, Constant Care and The Living Kitchen are registered trademarks and service marks of Sub-Zero, Inc. (collectively, the "Company Marks.") All other trademarks or registered trademarks are property of their respective owners in the United States and other countries.

# Wolf Appliance Products Limited Warranty

FOR RESIDENTIAL USE ONLY

## FULL TWO YEAR WARRANTY\*

For two years from the date of original installation, your Wolf Appliance product warranty covers all parts and labor to repair or replace, under normal residential use, any part of the product that proves to be defective in materials or workmanship. All service provided by Wolf Appliance under the above warranty must be performed by Wolf factory certified service, unless otherwise specified by Wolf Appliance, Inc. Service will be provided during normal business hours.

## LIMITED FIVE YEAR WARRANTY

For five years from the date of original installation, Wolf Appliance will repair or replace the following parts that prove to be defective in materials or workmanship: gas burners (excluding appearance), electric heating elements, blower motors (ventilation hoods), electronic control boards, magnetron tubes and induction generators. The part(s) will be repaired or replaced, free of charge, with the owner paying for all other costs including labor. All service provided by Wolf Appliance under the above warranty must be performed by Wolf factory certified service, unless otherwise specified by Wolf Appliance, Inc. Service will be provided during normal business hours.

## TERMS APPLICABLE TO EACH WARRANTY

The warranty applies only to products installed for normal residential use. The warranty applies only to products installed in any one of the fifty states of the United States, the District of Columbia or the ten provinces of Canada. This warranty does not cover any parts or labor to correct any defect caused by negligence, accident or improper use, maintenance, installation, service or repair.

**THE REMEDIES DESCRIBED ABOVE FOR EACH WARRANTY ARE THE ONLY ONES THAT WOLF APPLIANCE, INC. WILL PROVIDE, EITHER UNDER THIS WARRANTY OR UNDER ANY WARRANTY ARISING BY OPERATION OF LAW. WOLF APPLIANCE, INC. WILL NOT BE RESPONSIBLE FOR ANY CONSEQUENTIAL OR INCIDENTAL DAMAGES ARISING FROM THE BREACH OF THIS WARRANTY OR ANY OTHER WARRANTY, WHETHER EXPRESS, IMPLIED OR STATUTORY.**

Some states do not allow the exclusion or limitation of incidental or consequential damages, so the above limitation or exclusion may not apply to you. This warranty gives you specific legal rights and you may also have other legal rights that vary from state to state.

To receive parts and/or service and the name of Wolf factory certified service nearest you, contact Wolf Appliance, Inc., P.O. Box 44848, Madison, WI 53744; check the contact & support section of our website, [wolfappliance.com](http://wolfappliance.com) or call 800-222-7820.

\*Stainless steel doors, panels, handles, product frames and interior surfaces are covered by a limited 60-day parts and labor warranty for cosmetic defects.

\*Replacement filters for ventilation hood recirculating kits are not covered by the product warranty.







WOLF APPLIANCE, INC. P. O. BOX 44848 MADISON, WI 53744 WOLFAPPLIANCE.COM 800.222.7820

820364 REV-A

2/2012

